

ROYAL
AERONAUTICAL SOCIETY
OF GREAT BRITAIN



MINISTRY OF AVIATION

AERONAUTICAL RESEARCH COUNCIL

CURRENT PAPERS

Tests on a Hunter F.2 of Two
Strain Gauge Methods for
Measuring Tailplane Loads
in Flight, with some Loads
Measured in Level Flight,
Pitch-ups and Transonic Dives

by

O. P. Nicholas, B.Sc.(Eng.)

LONDON. HER MAJESTY'S STATIONERY OFFICE

1964

PRICE 11s 6d NET

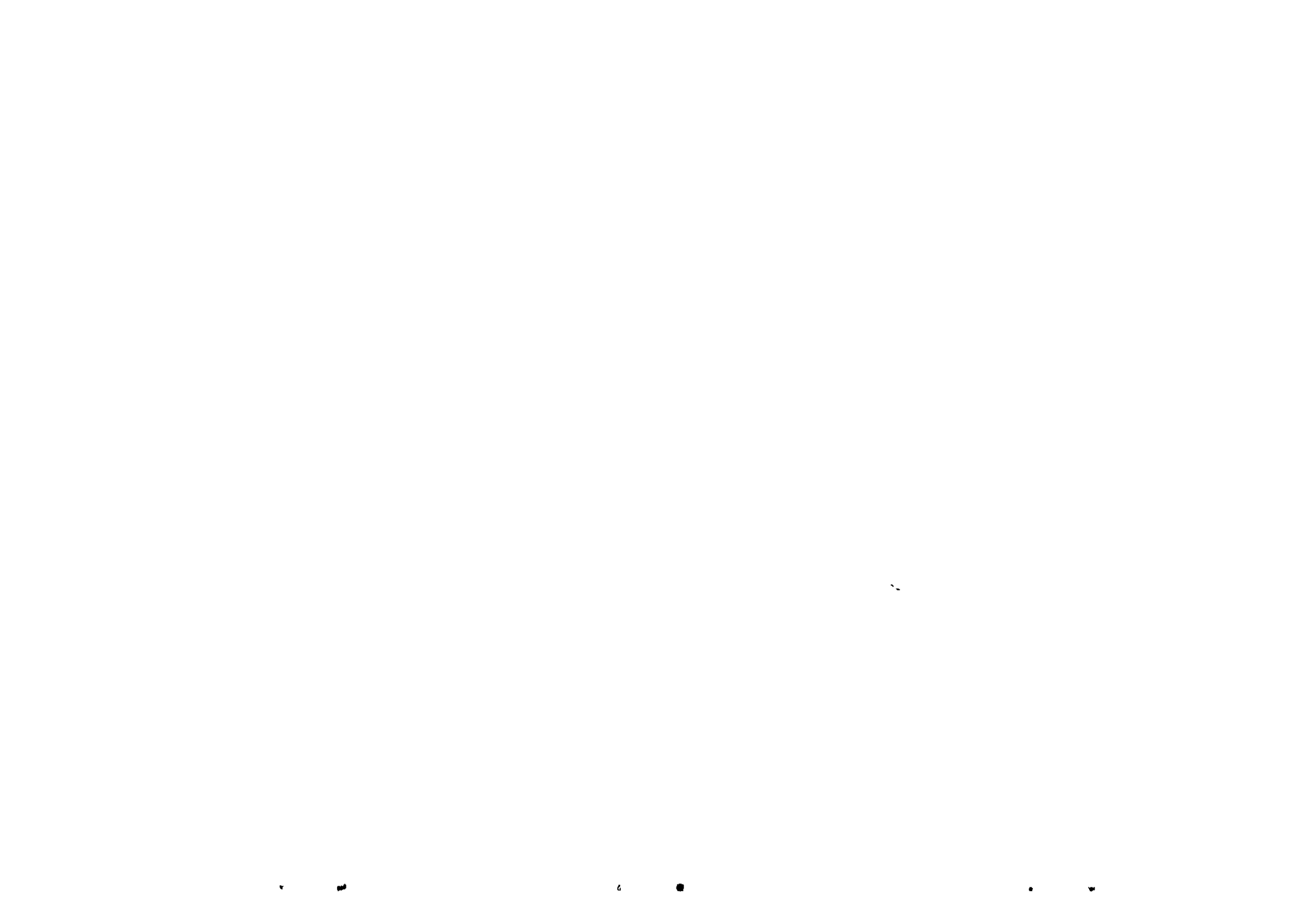

C.P. No.754

April 1963

TESTS ON A HUNTER F.2 OF TWO STRAIN GAUGE METHODS FOR MEASURING
TAILPLANE LOADS IN FLIGHT, WITH SOME LOADS MEASURED IN LEVEL
FLIGHT, PITCH-UPS AND TRANSONIC DIVES

by

O.P. Nicholas, B.Sc. (Eng.)

SUMMARY

Two methods for measuring tailplane loads have been tested in flight on a Hunter F.2 aircraft. One method used modified tailplane mountings which provided a satisfactory means of checking, in flight, the datums of their strain gauge bridges. Although hysteresis and other non-linearities in the load calibrations, together with fairly rapid temperature drift, limited the measuring system's usefulness in the flight tests, it appears that, with refinements in design, it should offer a good method for measuring absolute tail loads. The second measuring system, using shear strain gauges attached to the fuselage sides ahead of the tailplane, gave suitable load calibrations but was subject to considerable temperature drift. Reasonable agreement was obtained between the two systems, on incremental changes in aerodynamic load, over short time intervals (less than 30 seconds). In all cases the maximum loads measured were well below the structural strength limitations of the aircraft.

LIST OF CONTENTS

| | <u>Page</u> |
|---|-------------|
| 1 INTRODUCTION | 4 |
| 2 BRIEF DESCRIPTION OF THE AIRCRAFT | 5 |
| 3 LOAD MEASURING EQUIPMENT AND INSTRUMENTATION | 5 |
| 3.1 Measurement of tail loads at the tailplane mountings | 5 |
| 3.2 Measurement of tail loads by fuselage shear strain gauges | 7 |
| 3.3 Supporting instrumentation | 9 |
| 4 CALIBRATIONS | 9 |
| 4.1 Tailplane mountings | 9 |
| 4.2 Fuselage shear gauges | 11 |
| 4.3 Galvanometer dynamic response | 12 |
| 4.4 Supporting flight instrumentation | 13 |
| 5 BEHAVIOUR OF LOAD MEASURING EQUIPMENT IN FLIGHT | 14 |
| 6 ANALYSIS OF FLIGHT LOADS | 15 |
| 6.1 In-flight calibration procedures | 15 |
| 6.2 Determination of aerodynamic loads | 16 |
| 7 FLIGHT TESTS TO MEASURE LOADS | 18 |
| 7.1 Flight tests to measure loads in level flight | 18 |
| 7.2 Flight tests to measure loads in pitch-ups | 19 |
| 7.3 Flight tests to measure loads in transonic dives | 22 |
| 8 DISCUSSION | 22 |
| 8.1 Measuring techniques | 22 |
| 8.2 Loads measured | 24 |
| 9 CONCLUSIONS | 25 |
| LIST OF REFERENCES | 26 |
| | |
| TABLE 1 - Aircraft data | 28 |
| ILLUSTRATIONS - Figs.1-21 | - |
| DETACHABLE ABSTRACT CARDS | - |

LIST OF ILLUSTRATIONS

| | <u>Fig.</u> |
|---|-------------|
| General view of Hunter WN 893 | 1 |
| Hawker Hunter F.2 WN 893 | 2 |
| Diagram of rear fuselage and tailplane of Hunter, showing position of strain gauges | 3 |
| Diagram of hinge block | 4a |
| Diagram of front lever | 4b |

LIST OF ILLUSTRATIONS (Contd.)

| | <u>Fig.</u> |
|--|-------------|
| Hinge block insert, showing fretting which occurred in use | 5a |
| Front lever, without strain gauges | 5b |
| Inside of rear fuselage, showing Shear 2 strain gauges | 6 |
| Straining rig used to calibrate tailplane mountings | 7 |
| Calibrations of hinge blocks and front lever | 8a |
| Starboard hinge down-load calibration to show hysteresis effects | 8b |
| Calibration of fuselage Shear 1 bridge | 9 |
| Typical load records during in-flight datum determination | 10 |
| Loads indicated by shear bridges in level flight at 200 knots | 11 |
| Typical load records during pitch-up buffet | 12 |
| Loads measured in level flight at 20,000 feet - forward C.G. | 13a |
| Loads measured in level flight at 20,000 feet - aft C.G. | 13b |
| Aerodynamic centre of wing plus fuselage ahead of shear gauges | 14 |
| Time history of a pitch-up at $M = 0.9$, with immediate recovery | 15a |
| Buffeting loads during the pitch-up shown in Fig.15a | 15b |
| Maximum normal acceleration in pitch-ups | 16 |
| Range of aerodynamic load in pitch-ups, versus Mach number | 17 |
| Range of aerodynamic load in pitch-ups, versus maximum normal acceleration | 18 |
| Maximum hinge buffet amplitude in pitch-ups | 19a |
| Maximum front lever buffet amplitude in pitch-ups | 19b |
| Maximum shear buffet amplitude in pitch-ups | 19c |
| Downwash ahead of tailplane at mid-span | 20 |
| Time history of a transonic dive | 21 |

1 INTRODUCTION

Although ground testing of the strength of an airframe has become a recognised feature of the design of most new aircraft, comparatively little experimental work has been done to confirm that the loads which are assumed for design purposes, and which form the basis for these ground strength tests, do, in fact, correspond to those to which the aircraft is actually subjected in flight. The tests described in this Note were made several years ago. At that time the need for a more certain knowledge of the actual safety margin in the strength of the aircraft was emphasised by several current aerodynamic problems, such as the pitch-up behaviour resulting from longitudinal instability at high lift coefficients, and the large trim changes which could occur when passing through the transonic speed region. Characteristics such as these could, potentially, lead to manoeuvres in which excessive loads might be applied to the aircraft structure. A more recent example, which is not however considered further in this note, concerns the overstressing of the aircraft fin which may occur during certain rolling manoeuvres, resulting from the excessive sideslip angles induced by inertial cross coupling effects.

The aim of the present tests was therefore to gain a better understanding of the techniques of flight load measurement, in measuring both the fairly static loads experienced in steady flight, and the rapid loads applied during manoeuvres. In particular, the absolute values of the loads throughout the flight were required, rather than incremental loads measured over short time intervals.

The interest in the pitch-up and transonic trim change problems led to the choice of tailplane loads as the subject for the investigation. Two methods of measurement could be considered, pressure plotting and strain gauging. Pressure plotting had a possible general advantage in that it would give detailed information on the load distribution, although in this case that was not required, but at the same time it had the disadvantage that a large amount of analysis would be required in order to extract any overall load results. Another disadvantage was that the instrumentation available at that time was not well suited to the measurement of large numbers of transient pressures in flight. For these reasons the pressure plotting method was not adopted.

The alternative method of measuring the loads by strain gauges seemed to be more satisfactory, particularly since the tailplane mounting of the aircraft chosen for these tests, a Hunter F.2, was such that it appeared to be possible to measure the total load on the tailplane by the use of only a small number of strain gauge bridges. On the other hand the well known dependence of the strain gauge output on temperature and thermal stress presented difficult problems in preventing excessive drift of the strain gauge datums, especially during the lengthy period of a complete flight, and under the wide variation in ambient conditions experienced. In this experiment, attempts were made to overcome these difficulties by careful temperature compensation of the strain gauge bridges, and by attaching the gauges to specially modified tailplane mountings which allowed the unloaded output of the bridges to be read from time to time during the flight. However, neither of these precautions was wholly satisfactory in overcoming the problem of datum drift, and it was not possible, with the present equipment, to establish a continuous record of the absolute tailplane loads throughout the flight.

In addition to the gauges attached to the tailplane mountings, some measurements were also made of the output of strain gauge bridges attached to the skin of the rear fuselage. The position of these gauges was chosen so that they should respond to the total shear loading on the rear fuselage, and this, of course, contained a major contribution from the tailplane load. Despite careful temperature compensation of the bridges, datum drift was again a major problem, and, in this case, there was no readily available method of determining their unloaded output in flight.

Tail loads were measured in level flight, pitch-ups and transonic dives. Although datum drift reduced the accuracy of the results, it can be said with reasonable confidence that, under the conditions tested, the loads were well below the structural strength limitations of the aircraft.

2 BRIEF DESCRIPTION OF THE AIRCRAFT

The Hawker Hunter F.2 is a single seat swept-wing fighter powered by an Armstrong Siddeley Sapphire engine. It has a mid wing with an aspect ratio of 3.33, a sweep of 40 degrees at the quarter chord line, and a thickness to chord ratio of 0.085. Longitudinal control is by power assisted elevators fitted to a variable incidence tailplane. Manoeuvring is normally carried out by using the elevators alone, the variable incidence tailplane being used solely for trimming the aircraft. The quarter chord point of the tailplane is situated 1.89 wing aerodynamic mean chord lengths behind the wing quarter chord point, and is 37.3% of the wing aerodynamic mean chord above the extended wing root chord line.

The aircraft used in the tests, WN 893, is shown in the photograph Fig.1, and the two view drawing Fig.2. It had the following external differences from a standard Hunter F.2:

- (a) A nose boom pitot-static head fitted with an incidence vane.
- (b) Two booms attached to the tailplane (at approximately mid semi-span on each side), one fitted with an incidence vane and the other with a pitot-static head.

The dimensions of the aircraft are summarised in Table 1.

3 LOAD MEASURING EQUIPMENT AND INSTRUMENTATION

3.1 Measurement of tail loads at the tailplane mountings

The variable incidence tailplane of the standard Hunter F.2 is carried on short fixed shafts which project from either side of the fin. Bearing blocks attached to the rear spar of the tailplane mate with these shafts to form a pivot, so that the tailplane incidence can be varied by a jack connected to a lever fixed at the front of the tailplane. The loads applied to the tailplane are transferred to the fuselage partly through the bearing blocks (hinge blocks) and the fixed shafts, and thence via the fin to a fuselage frame, and partly through the front lever and tailplane actuator. The positions of these mountings are shown in Fig.3

In the test aircraft the standard hinge blocks and front lever were replaced by modified units carrying strain gauges. This method of tailplane load measurement was similar to that employed in Ref.1. It had the advantage over the more usual one of strain gauging the root of the tailplane^{2,3}, that it required fewer strain gauge bridges, and in addition the calibrating technique was much simpler. In an attempt to overcome the problems of strain gauge datum drift, the measuring units used on the Hunter were designed in such a way that the unloaded output of each of the bridges could be determined at intervals during flight. This added facility of in-flight determination of datums appeared to offer considerable advantages, although it also involved additional complication. It was provided by arranging that at each of the tailplane mountings up loads and down loads were measured separately using two independent strain gauge bridges. The output of each of these bridges when unloaded could be determined in flight, since, when an up load bridge gave a definite output, the corresponding down load bridge was known to be unloaded, and vice versa. In this way errors due to datum drift were minimised. The flying technique used when these zero load records were required is described in Section 5.

The modified tailplane mounting members were made of EN25V high tensile steel having an ultimate tensile stress of 150,000 lb per square inch. Since the maximum loads which would be encountered in flight could not be assessed with any confidence in advance, it was necessary to design the mountings with considerable safety margins. The design calculations were based on a strain in the gauged portions of approximately 3,000 lb per square inch per 1,000 lb load. This introduced problems due to the small strains that were encountered under most flight conditions, but was unavoidable.

The modified hinge blocks consisted essentially of two components, as shown in Figs.4a and 5a; one was a strain gauged member which pivoted on the fin shaft, and the other an outer case which contained this member and was bolted to the rear face of the tailplane rear spar. The case was itself made of two parts, the main body and a rear cover plate, to allow the hinge block to be assembled. The inner member (the insert) was a close sliding fit in the outer case, which restrained it horizontally but allowed it a certain amount of free vertical movement. This free movement was limited at the top by the insert's upper stub coming into contact with the inside of the top of the case, and similarly at the bottom by the insert's lower stub coming into contact with the inside of the bottom of the case. The tailplane was restrained in a spanwise sense by the inboard face of one or other of the hinge block cases bearing against a shoulder on the fixed pivot shafts on the fin, in the same way as when the standard hinge blocks were fitted. Chordwise movement of the tailplane was prevented because the hinge block cases fitted closely on their inserts. The vertical play of the inserts within their cases allowed a total of approximately 0.002 inches overall vertical movement of the tailplane at each hinge block (0.001 inch either side of the neutral position), before the case came into contact with either the upper or lower stub of its insert. Thus, if the overall load on the tailplane produced a resultant up load on a hinge block, the case would move upward to the limit of its travel and then put the lower stub of its insert into compression, leaving the upper stub unloaded, and vice versa. The stubs were slightly dome ended to reduce loading asymmetries. The compressive strain in each of them was measured by strain gauges, mounted as shown in Figs.4a and 5a. The stubs were only sufficiently large for two gauges to be attached to them, so it was necessary to

use strain gauge bridges having only two active arms of one gauge each. To give temperature compensation, dummy gauges were used for the other two arms, and since there was no suitable free space for them on the inserts, they were attached to inserts in identical unloaded dummy blocks mounted 6 inches away in the tailplane root.

The strain measured by the gauges on the stubs was approximately 8×10^{-5} , corresponding to a stress of 2,400 lb per square inch, per 1,000 lb load. Some stress concentration was occurring since the mean stress had been calculated as 3,200 lb per square inch per 1,000 lb load, but it was considered that the safety margin was still adequate. The strain gauge bridges consisted of four 120 ohm gauges, with an energising supply of 10 volts. This resulted in a current, in the 90 ohm galvanometers used, of approximately $2.5 \mu\text{A}$ per 1,000 lb load.

The modified front lever was designed on the same principle of measuring up and down loads separately. It was split at the jack attachment point, as shown in Figs. 4b and 5b, to form two cantilevers. A load on the tailplane which produced a resultant up load on the front lever caused the lower cantilever to be stressed, and left the upper cantilever unloaded (since the jack attachment pin retained its normal working clearance), and vice versa. Bending strain in each cantilever was measured by strain gauge bridges, each consisting of two tension and two compression gauges connected to form four active arms.

The level of strain at the gauge positions was approximately the same as that in the hinge blocks, and as the front lever had bridges with four active arms, its load sensitivity was approximately twice as great as that of the hinge blocks with their two active arm bridges. Less sensitive galvanometers were used to record the front lever signals than were used for the hinge blocks.

The effects of any tailplane distortion were assessed as small. Providing any bending of the rear spar that occurred between the two hinge blocks (9.9 inches apart) was small, no root bending moments would be transmitted to the blocks, and normal and chordwise loads on the tailplane would produce only normal and chordwise loads, respectively, on the blocks. The front lever was only subjected to loads along the jack axis. It should have been unaffected by any normal amount of tailplane distortion.

3.2 Measurement of tail loads by fuselage shear strain gauges

The use of rear fuselage shear gauges on the Hunter appeared to offer an alternative means of tailplane load measurement, and it had the potential advantage as a measuring system, that it could be fairly easily applied to most existing aircraft. Some tests making use of this method were therefore included in the investigation.

The principal strains that are associated with the shear strain produced in a cantilevered beam by a load at its free end, can be measured by a strain gauge bridge having two active gauges attached to one side of the beam.

The gauges have to be positioned on the neutral axis for this loading, and aligned along the principal planes. This simple arrangement should, theoretically, be insensitive to the bending moment produced by the load, to compressive loads along the beam's longitudinal axis, and to torsion about this axis. The bridge can also be rendered insensitive to the effects of loads other than those acting in the plane of interest, by mounting an exactly similar pair of gauges on the other side of the beam, and connecting all four gauges to form a four active arm bridge. The neutral axis of the cross section of an ideal circular tube is the diameter which lies perpendicular to the plane of the applied bending moment; i.e. in this case, the diameter perpendicular to the plane containing the loads of interest. For this ideal circular tube, the principal planes are perpendicular to the plane containing the loads of interest, and at 45 degrees to the longitudinal axis.

The rear fuselage of a Hunter F.2, although obviously not the ideal tube considered above, is a simple circular structure having frames 11 inches apart and light stringers 7 inches apart. The skin consists of three 0.064 inch thick aluminium alloy panels, joined at the fuselage top and at 120 degrees down each side. A non-load-carrying spine runs along the fuselage top and merges into the fin. The photograph (Fig.6) shows part of the inside of the rear fuselage of the test aircraft (with the jet pipe removed). A pair of strain gauges can be seen in the centre of the photograph and these are part of the Shear 2 bridge (see below).

Since the only significant asymmetries of the circular rear fuselage were the skin joints, strain gauges were centred on the horizontal diameter midway between two frames. The nearest stringers were also equidistant. Because the internal structure was light it seemed possible that, under load, the strain in the skin at the gauge positions would vary in a similar manner to the strain in an ideal tube. If this was so, a shear strain bridge would have an output proportional to the total normal load aft of the gauges, and independent of the position of this load. The bridge would also be insensitive to side loads on the fin and rear fuselage, twisting moments on the rear fuselage, drag loads, etc. Before such a bridge could be used to measure loads in flight, it was necessary to confirm experimentally that its output did, in fact, behave in this fashion. The calibration technique, and the results obtained, are described in section 4.2.

Two independent shear strain gauge bridges were attached to the fuselage sides of the test aircraft, ahead of the tailplane, in the positions shown in Fig.3. These bridges were termed Shear 1 and Shear 2. The Shear 1 bridge was located midway between frames 47 and 48. It consisted of four 120 ohm gauges, two on the outside of the skin on each side of the fuselage. The Shear 2 bridge was located midway between frames 48 and 49. In order to minimise the effect of any skin buckling each arm of this bridge consisted of two gauges in series. One gauge of each pair was attached to the outside of the skin, and the other was attached to the inside in the same position. The eight gauges used in the Shear 2 bridge were 65 ohms each, so as to produce a bridge which was reasonably similar, electrically, to the Shear 1 bridge with its four 120 ohm gauges. The gauges in each bridge were matched for change of resistance with temperature before cementing them to the skin. A thermistor was attached to the inside of the skin near one set of gauges of the Shear 2 bridge, to enable the skin temperature to be recorded.

The bridges were energised by a 10 volt supply and connected to 90 ohm galvanometers. The output of each bridge was approximately $2.5 \mu\text{A}$ per 1,000 lb for vertical loads applied 7 feet aft of the Shear 1 bridge position. This output corresponds to a principal strain of 2.7×10^{-5} per 1,000 lb load, under this loading condition. This value agrees closely with the calculated strain in the rear fuselage skin on the horizontal diameter, using the simplifying assumptions that the skin is uniform, has no cut-outs, and takes all the shear loads. Again, the low level of strain that was encountered under most flight conditions introduced problems with this measuring system.

3.3 Supporting instrumentation

The outputs of the various strain gauge bridges were recorded, without amplification, by galvanometers in a Beaudouin A13 trace recorder. An interrupter electrically displaced the traces in turn every 2 seconds, to provide a means of trace identification.

The following quantities relevant to the tests were recorded on two Hussenot A22 trace recorders:-

Elevator angle

Normal acceleration

Rate of pitch

Rate of roll

Fuselage datum incidence

Tailplane incidence

Fuselage attitude (pendulum level)

Fuselage skin temperature near Shear 2 gauges

Strain gauge supply voltage.

Standard instruments on an automatic observer panel, photographed at 8 frames per second, were used to record:-

Indicated airspeed)
Indicated altitude) Connected to nose-boom pitot-static head.

Tailplane angle to fuselage datum.

The quantity of fuel remaining was noted by the pilot before and after taking each record.

4 CALIBRATIONS

4.1 Tailplane mountings

A rig for applying loads to the tailplane was clamped to the rear fuselage (Fig.7) and used to calibrate the tailplane mountings. All calibrations

were done with the tailplane at zero angle to the fuselage datum. Screw jacks fitted to the rig applied symmetrical vertical loads to the tailplane at approximately 30% semi-span, through calibrated spring units. The hinge blocks could be loaded between +3,000 lb and -4,000 lb and the front lever between +3,700 lb and -2,700 lb (up load positive).

The hinge block calibrations showed considerable hysteresis. Some also showed other non-linearities, particularly when small loads were applied. The calibrations were repeated several times during the period of flight tests, and the hysteresis and other non-linearities were essentially constant. A typical set of calibrations is shown in Fig.8a. A calibration to determine the behaviour of the poorest hinge block when subjected to varying load cycles is shown in Fig.8b. It can be seen that, in particular, the range of any unidirectional fluctuating loads will be underestimated. It is thought that the form of the calibrations could have arisen from two causes:-

- (a) Non-axial loading of the short compression stubs.
- (b) Friction between the insert and the case.

As a check on the behaviour of the hinge blocks they were removed from the aircraft during the flying programme, and individually calibrated (as complete units) using a compressive load along the measuring axis. Under these conditions little hysteresis was apparent, and no other non-linearities occurred, but when refitted to the aircraft the calibrations reverted to the original form. This suggested that there might be some misalignment, when the hinge blocks were fitted in the aircraft, so that they were not then subject to the same pure loading as was used in the laboratory test. However, it was not necessary to use any force while fitting the hinge blocks to the aircraft, and, once fitted, the tailplane was free to move between the limits set by the play in the hinge blocks without any evidence of binding. It might have been possible to determine if changes in tailplane distortion affected the hinge block hysteresis, by applying the calibrating load at different points on the tailplane. Unfortunately the calibrating rig had only been designed to apply loads at one position, and no such tests were conducted. In flight the response of the hinge blocks may have differed still further from their calibration in isolation, since chordwise loads were then present, and possibly also effects due to rotating the tailplane on its hinge blocks while under load. When flying had been completed the hinge blocks were dismantled, and both showed signs of rubbing between the insert and outer case (photograph Fig.5a). It therefore appears that the hysteresis in the calibrations was at least partly caused by friction between the insert and the case when the hinge blocks were fitted in the aircraft.

The incidence actuating jack of the Hunter F.2 is in the plane of symmetry of the aircraft, and is inclined at approximately 3° to the vertical datum. The load measuring front lever was calibrated in terms of the vertical load at that point, but only when the tailplane angle was zero. The total range of tailplane movement was $\pm 2.5^\circ$, and it was considered that the corresponding changes in angle between the jack and front lever would have little effect on the load sensitivity of the front lever. The front lever calibrations were straight lines, with a hysteresis of ± 80 lb for a load cycle which subjected each cantilever to a load varying from zero to approximately 3,000 lb and back to zero. A typical calibration is shown in Fig.8a.

4.2 Fuselage shear gauges

As stated in section 3.2 it was necessary to determine the sensitivity of the fuselage shear strain gauge bridges, both to shear and to other types of loading. Both shear bridges were found to behave very similarly when being calibrated, so only the results obtained during the calibration of the Shear 1 bridge will be discussed.

(a) The bridge was first calibrated for shear, using varying loads applied at a fixed distance from the gauges. A range of loads from -3,300 lb to +1,700 lb was covered (up loads positive), using bags of lead shot to apply down loads, and a crane to apply up loads via a spring balance. The bridge calibration was a straight line, with a hysteresis of ± 40 lb for a load cycle of zero to 3,300 lb to zero. A typical calibration is shown in Fig.9.

(b) Shot bags placed on the tailplane and rear fuselage were used to apply a shear load of 1,000 lb to the rear fuselage. By placing this load in different positions the bending moment it produced at the gauge position was varied between 5,000 lb ft and 10,000 lb ft, while the shear load remained constant. As the bending moment increased from 5,000 lb ft the shear bridge output rose until it was approximately 10% higher at 7,000 lb ft and then fell so that it reattained its original value at 10,000 lb ft.

(c) Shot bags placed near one tip of the tailplane at a time were used to apply torsion loads to the fuselage. At a constant shear load of 800 lb the effect of torsion of $\pm 2,300$ lb ft was undetectable.

For an ideal circular tube, no change in shear bridge output during tests such as (b) and (c) would be sufficient to indicate that the gauges were mounted on the neutral axis for vertical bending, and were symmetrically orientated with regard to the longitudinal axis. If these conditions applied, then the bridge on the ideal tube would also be insensitive to horizontal shear, horizontal bending moments and longitudinal loading. Since these further loadings could not conveniently be applied to the Hunter fuselage it was assumed, by analogy with the ideal tube, that the sensitivity of the Hunter bridges to these other forms of loading was small, since tests (b) and (c) showed that their sensitivity to bending moments was relatively small and that their sensitivity to torsion was negligible. The loading positions used in the bending moment test (b) were in the region of the tailplane, and covered a range as large as the tailplane aerodynamic mean chord. However, the inertia and aerodynamic loads on the rear fuselage would be distributed over a wider range than this, thereby increasing the measuring uncertainty arising from the bridges' sensitivity to bending moments.

The thermally matched gauges which made up each shear bridge on the Hunter had been chosen from a batch of gauges whose resistance variation with temperature had been measured by the following technique. The gauges were lightly clamped between two $\frac{1}{4}$ inch alloy plates, one faced with a thin sheet of P.T.F.E. and the other with sponge rubber faced with P.T.F.E. In this way the gauges were held flat and in reasonably close thermal contact with a large mass, while they were heated in an oven to various steady temperatures. The resistance of the gauges was measured at each temperature, using a Wheatstone bridge circuit. Gauges having similar characteristics were then

chosen from graphs of resistance against temperature, and it was calculated (with the aid of a subsequent load calibration) that the temperature sensitivity of the complete bridges should be in the order of 2 lb per degree C. However, preliminary flight tests (see section 6.1) showed that in flight the temperature sensitivity of the complete bridges was in the order of 15 lb per degree C, or approximately ten times as large as had been expected. This discrepancy could have been caused by:-

- (a) Insufficient accuracy in determining the resistance versus temperature characteristics of the gauges.
- (b) A differential change in these characteristics when the gauges were cemented to the fuselage.
- (c) Differences between the gauge factors, or coefficients of expansion, of the different gauges.
- (d) Thermally induced stresses in the fuselage structure. A drift of 15 lb per degree C would be equivalent to a strain change of 4×10^{-7} per degree C.

In order to investigate the discrepancy between the anticipated temperature sensitivity of the shear bridges and that actually measured in flight, attempts were made to determine the sensitivity under no-load conditions on the ground. The fuselage was heated by running the engine, and also with electric blankets, but neither of these methods produced sufficiently large temperature changes for any consistent change of datum with temperature to be apparent. When the tail load programme on the aircraft had been completed, it was not required for any further flying, so the panels on which the Shear 2 gauges were mounted were cut out to enable further tests to be conducted in the laboratory. The panels were placed in a refrigerator and supported so that they were unstressed. Under these conditions the temperature sensitivity of the bridge was equivalent to a tail load of -14 lb per degree C. This test showed that little of the temperature sensitivity of the bridge in flight was caused by thermal stresses in the fuselage. This confirms that the temperature sensitivity was probably due to the effects of (a), (b) and (c) above.

Ref.4 presents the results obtained with gauges that had been matched using a similar technique, except that the gauges were heated by immersion in a paraffin bath instead of in an oven. It was found that bridges made from gauges selected after this calibration had residual errors, after adhesion (to steel) and wiring up, that were the equivalent of up to 7 lb/sq in per degree C over a temperature range of 15°C to 45°C. A temperature sensitivity of this order in the Hunter shear bridges would have been equivalent to 30 lb tail load per degree C. Hence the temperature sensitivity of approximately 15 lb per degree C that was actually found in these bridges was of an order that could be expected to be due solely to the effects of (a), (b) and (c) above.

4.3 Galvanometer dynamic response

Dynamic response tests were made on the galvanometers connected to the strain gauge bridges, in order that loads could be determined during buffeting of the tailplane. There were two cases to consider:-

(a) A bridge in which the strain during buffeting varied continuously.

(b) A bridge in which the strain remained at zero for part of each cycle during buffeting. This was the case when the buffet was sufficiently intense to produce reversals in the direction of load on the tailplane hinge blocks or front lever.

Because of the shortcomings of the load measuring systems it was not considered to be necessary to make a rigorous treatment of the galvanometer response corrections during buffeting. To simplify the determination and application of these corrections the galvanometer response to sine waves has been used for case (a), and the response to the positive half cycles of a train of sine waves for case (b). Conventional frequency response tests were used to determine the galvanometer response to full sine waves. Typical values for the hinge block and shear galvanometers were a natural frequency of 21 cycles per second and a damping ratio 1.13 of critical. Different strain gauges and galvanometers were used for the front lever, and in this case typical values were a natural frequency of 36 cycles per second and a damping ratio 0.88 of critical. The high damping arose because the galvanometers were connected directly to the relatively low resistance strain gauge circuits, so as to obtain the maximum static sensitivity. The galvanometer amplification factor for the half sine wave type of input was determined experimentally, over a range of frequencies, using an oscillator and a half wave rectifier.

These tests showed that the dynamic response of the galvanometers was such that no correction to their indications was required at normal rates of tail load variation. During buffeting, however, the frequencies were such that corrections were required. In the worst case, namely full sine waves at 13 cycles per second on a 21 cycle per second galvanometer, the correction increased the indicated amplitude of the buffet load by approximately 50%.

4.4 Supporting flight instrumentation

Equivalent airspeed, true pressure altitude and Mach number were calculated using known position error corrections².

The incidence vane on the nose boom was calibrated in subsonic flight for the combination of boom, fuselage and wing upwash, by comparing the vane reading with the fuselage attitude in stabilised levels. The fuselage and wing upwash errors are only present in subsonic flight, so in supersonic flight a theoretically estimated factor (based on the flow round a cylinder) was used to correct the vane readings for boom upwash alone. Vane readings were also corrected for aircraft rate of pitch, to give true aircraft incidence.

The incidence vane on the tailplane boom measured the angle of the airflow ahead of the tailplane, relative to the chord line of the tailplane. The vane readings were corrected for tailplane upwash (at subsonic speeds only), and boom upwash, using theoretically estimated factors. The upwash due to the tailplane was estimated on the basis of a single full span horse-shoe vortex on the tailplane quarter chord line. At small incidences the error due to this simplified representation should be small. When the tailplane incidence was

large (i.e. during the pitch-up) so also was the wing incidence, and the flow in the region of the tailplane was then markedly three dimensional^o. This introduced large unknown errors which made it impracticable to attempt to apply a suitable correction to the tailplane vane readings. A more accurate representation of the upwash due to the tailplane than the one used, would therefore not have been justified. When the tailplane vane was used to determine the downwash angle it was necessary to apply a further correction for aircraft rate of pitch.

5 BEHAVIOUR OF LOAD MEASURING EQUIPMENT IN FLIGHT

The tailplane mountings had been designed to measure up and down loads on separate strain gauge bridges (see section 3.1). By rapid up and down elevator movements the pilot could produce sufficiently large variations in tail load to reverse the loads on the mounting points. When an up load bridge gave a definite output the corresponding down load bridge was known to be unloaded, and vice versa. A typical flight record is reproduced in Fig.10. From such a record the zero load outputs of the tailplane mounting bridges could be determined in flight, and this minimised errors due to strain gauge drift.

The designs of mountings employed were completely satisfactory from the aspect of in-flight datum determination, but they suffered from various shortcomings. The rate of datum drift of the hinge blocks was up to 400 lb per minute, and the maximum drift noted in any one flight was 1,500 lb. Corresponding figures for the front lever were a rate of 100 lb per minute and a maximum drift of 1,000 lb. In consequence it was necessary to determine a datum immediately before each manoeuvre. Ground calibrations of the hinge blocks showed considerable hysteresis and other non-linearities, when they were installed in the aircraft, although this was not apparent when they were calibrated in isolation. The front lever calibrations showed considerably less hysteresis than the hinge blocks, and had no other non-linearities. It was not possible to assess the form of the calibrations in flight, when additional chordwise loadings that were not present on the ground may have produced further changes in the hinge block calibrations. The hysteresis and other non-linearities had several undesirable effects. Firstly, when the flight loads were small it was impracticable to use the tailplane mountings because of their low sensitivity to small loads; then, when flight loads were large, it was frequently necessary to use extrapolated calibrations, and the exact form these should take was uncertain; and finally, the accuracy of buffet load measurement was low because of the hysteresis.

It was found that the loads indicated in flight by the two shear bridges were in close agreement, apart from discrepancies which could be attributed to the effects of drift. It therefore appears (see section 3.2) that the effects of any skin buckling at the position of the Shear 1 gauges were small, up to the maximum shear loads encountered.

The fuselage shear strain gauges had been carefully matched for resistance change with temperature. Despite this, preliminary flight tests showed that their drift was considerable, in terms of load. The drift was assessed by taking records, at intervals during several flights, of the tail load in level

flight at 200 knots, the fuselage skin temperature being recorded at the same time. Altitudes in the range 1,000 to 40,000 feet were covered, at random, during these records. At constant equivalent airspeed, aircraft weight and centre of gravity position, the tail load should be constant provided Mach number effects are negligible. The speed of 200 knots was chosen so that these effects should be small up to 40,000 feet, as this was the altitude at which most of the flight tests were conducted. After correction for changes in aircraft weight and centre of gravity position these readings of load varied considerably, the output of each bridge showing considerable scatter but also a definite trend with skin temperature (Fig.11). Mean lines drawn through the large scatter in this figure show that the temperature sensitivity of the Shear 1 bridge was equivalent to approximately +15 lb per degree C, and that of the Shear 2 bridge to approximately -15 lb per degree C. The scatter superimposed on this temperature sensitivity increased with decreasing temperature, and reached ± 500 lb at the lowest skin temperature, -35°C . This scatter was also apparent to a lesser degree in readings taken on the ground with the tailplane unloaded. No attempt was made to measure the temperature difference between the two sides of the fuselage, and this might possibly have allowed a further correction to be applied to reduce the "random" drift. In further flight tests, described in section 7.1, the rate of random drift was found to be as high as 400 lb per minute under conditions of varying skin temperature. In Fig.11 both the shear bridges indicate the same aerodynamic load at $+19^{\circ}\text{C}$, which is approximately the temperature at which they had been calibrated on the ground. This load is +170 lb, and has been assumed to be the aerodynamic load, at 200 knots, on the tailplane and rear fuselage of a Hunter F.2 under the test conditions (centre of gravity 8 inches aft of datum [i.e. $30.4\% \bar{c}$] and weight 15,000 lb).

It was not possible to use the tailplane mounting bridges to determine the tail load at 200 knots with sufficient accuracy to enable a comparison to be made, because the hysteresis of the hinge block calibrations was large and they were insensitive to small loads.

6 ANALYSIS OF FLIGHT LOADS

Typical calibrations of the hinge blocks, front lever and fuselage shear strain gauge bridges are shown in Figs.8a and 9. Flight loads were analysed using a mean line drawn through the hysteresis loop in each calibration, and extrapolating this line as necessary. In the worst cases the extrapolation was to -9,500 lb (or to 230%) for a hinge block, to +5,000 lb (or to 135%) for the front lever, and to -7,600 lb (or to 230%) for a fuselage shear bridge.

6.1 In-flight calibration procedures

The datums of the strain gauge bridges on the tailplane mountings were determined, as described in the previous section, before each manoeuvre. When a long manoeuvre such as a transonic dive was carried out, a further set of datums was recorded after its completion. Any drift between the two sets was assumed to have been linear with time.

To minimise the effects of the datum drift of the fuselage shear bridges, a steady level flight trimmed condition at 200 knots equivalent airspeed (and less than 40,000 feet altitude, see section 7.1) was recorded before

each manoeuvre. With allowance for aircraft centre of gravity position and weight, this record established a point at a load of +170 lb on the calibration curves of the shear bridges. When the skin temperature varied during a manoeuvre a further correction for the temperature sensitivity of the bridges was applied. However a time of more than a minute might elapse between the 200 knot record and the manoeuvre, and it was not possible to allow for the random drift during this period. In section 7.1 the results of two particular flights are presented. These enable the magnitude of the drift corrections, the effectiveness of the technique, and the rate of random drift, to be assessed under typical conditions of varying skin temperature over a period of eight minutes.

6.2 Determination of aerodynamic loads

The structural loads measured by strain gauges under manoeuvring conditions represent the sum of aerodynamic and inertia loads. Hence it was necessary to apply inertia corrections to the structural loads recorded in manoeuvring flight, in order to find the actual aerodynamic loads. Tailplane buffeting was present at the high incidences encountered in pitch-ups, and under these conditions it was also necessary to apply corrections to the indicated loads, to take account of the galvanometers' dynamic response characteristics. The application of these two corrections to the load indications of the tailplane mountings, and fuselage shear gauges, is described in the following paragraphs.

The mass and centre of gravity of the tailplane had been measured, so the inertia loads could be calculated, using the normal and angular pitching accelerations measured at the aircraft centre of gravity. The angular pitching acceleration was determined from the rate of pitch gyroscope. This is not an accurate method since it involves the differentiation of a trace record; however the load corrections for pitching acceleration were much smaller than those for normal acceleration, so this had little effect on the overall accuracy of the inertia loads. Once the inertia load on the tailplane had been calculated, it was subtracted from the total load measured by the tailplane mountings, to give the aerodynamic load on the tailplane.

Inertia corrections were applied to the shear gauge indications by assuming that the total mass aft of the gauges contributed to the shear load. The mass and centre of gravity of this portion of a scrapped Hunter had been measured, so that the inertia loads could be calculated. Subtraction of these loads from the load measured by the shear bridges gave the total aerodynamic load aft of the gauge position, i.e. the load on the tailplane plus rear fuselage. A knowledge of the aerodynamic load on the rear fuselage would have been required if the aerodynamic load on the tailplane alone was to be found. At high incidences, when part of the wing was stalled, the flow at the rear of the aircraft was markedly three dimensional and not amenable to mathematical treatment. Hence there was no readily available method by which the aerodynamic load on the fuselage could be calculated for high incidences. For consistency the loads derived from the shear gauges have therefore been presented, at all incidences, as the total aerodynamic load aft of the gauges. However, a simple estimate has been made which should give a reasonable indication of the magnitude of the aerodynamic load on the rear fuselage at low incidences. For this estimate (by the method of Ref.7) the fuselage was treated as an isolated body. The loads

calculated were downwards under most flight conditions, and less than 200 lb except at the higher incidences (above 4°) during pitch-ups. The aerodynamic loads derived from the shear bridges would therefore, under most flight conditions, be expected to show somewhat smaller uploads and larger downloads than those derived from the tailplane mountings.

Any analysis of the buffet loads on the hinge blocks would have a low accuracy, because of the hysteresis in their calibrations. However, it was felt that some analysis of the loads on the tailplane mountings during buffet would be useful, as it would give an indication of the magnitude of the loads involved. The principal object of this analysis was to determine the magnitude of the loads on the individual mountings, but, since a comparison with the shear gauge indications would also be useful, the history of the aerodynamic load on the tailplane was also required. To obtain this it was necessary to be able to add the load histories of the individual mountings, in order to determine the total load history. The load records themselves could not be added, because of the different dynamic response of the hinge block and front lever galvanometers, and the fact that one mounting might be subjected to full sine waves while another was subjected to half sine waves (see section 4.3). However, since the mounting loads were in general approximately in phase or in antiphase, it was possible to adopt the following simplification when reading the records. Load readings were taken at times midway between the corresponding peaks in the load records of the different tailplane mountings (see Fig.12), and these readings were treated as if they had been the actual peaks in the load records. This method of reading had little effect on the magnitude of the loads determined (although it may have caused some phase distortion between the loads on the different mountings), and normally resulted in readings that were within 5% of the peak values of the records (as can be seen from the typical flight records reproduced in Fig.12).

The form of the loads at each gauge position was assumed to be a train of full or half sine waves as appropriate (see section 4.3). Thus amplification factors could be determined, from the results of the tests described in that section, to allow for the responses of the galvanometers at the frequencies encountered in the records. The corrections involved here were up to 50% of the indicated buffet amplitude. Time histories of the indicated loads, as measured from each pair of hinge block or front lever galvanometer records, were first plotted, and envelopes drawn round the buffeting portions. The galvanometer response corrections were then applied by drawing new envelopes, using the appropriate amplification factors. Fig.15b, graphs 1, 2, and 4, shows this process. Fig.12 is a reproduction of the load records during part of the period of Fig.15b, starting at a time of approximately 8.6 seconds.

The history of the tailplane aerodynamic load was required. At times corresponding to the load peaks originally plotted for each mounting, the corrected loads were read off the new buffet envelopes. These loads were added to give a total load history as shown in Fig.15b graph 5. From this the aerodynamic load on the tailplane was assessed by making the usual inertia corrections, and is shown (plotted as the mean during buffeting) in Fig.15a graph 10.

In this analysis the aircraft has been treated as a rigid body, and it has been assumed that the normal acceleration and angular pitching acceleration, measured at the aircraft centre of gravity, are sufficient to define

the normal motion of the rear of the aircraft. In fact it is apparent from the flight load records that a vertical bending vibration of the fuselage was set up during buffeting. The effect of this additional normal motion has not been included in the calculations to determine the inertia corrections, since no provision was made for measuring the rear fuselage motion. Although suitable instrumentation might have provided the further information needed, it was not considered that this would have been justified, because of the inherently low accuracy in the load measuring system due to the hinge block hysteresis.

It can be seen, from the small amount of hysteresis in the shear bridge calibrations, that the indications of buffet shear loads should be more reliable than those of buffet on the tailplane mountings. The load indications were corrected for galvanometer dynamic response in the same way as were the tailplane mounting loads. Since each shear bridge had its output on a single galvanometer it was only necessary to correct for the galvanometer response to full sine waves, see section 4.3. Fig. 15b graph 6 shows this process. Aerodynamic loads during buffeting were derived from the shear loads, by making the usual inertia corrections, and are shown in Fig. 15a graph 11 for comparison with the tailplane mounting indications under these conditions (Fig. 15a graph 10). However, as for the tailplane mounting indications, no attempt was made to correct for the effects produced by fuselage bending. In this case it would have been more difficult to determine the inertia corrections for fuselage bending, because of the distributed mass aft of the gauge position.

7 FLIGHT TESTS TO MEASURE LOADS

Tail loads were measured in level flight, pitch-ups and transonic dives. In order to limit the aircraft loads the pitch-ups were entered at 35,000 feet, and recovery from the transonic dives was completed above 20,000 feet. The choice of an altitude for the level flight measurements was based on several considerations. Firstly, smooth air conditions were required so that the small loads could be accurately measured. Secondly, it would be convenient to measure the loads at similar altitudes to those used for the other flight tests (20,000 to 40,000 feet). Thirdly, the minimum Mach number for level flight increases with altitude, so if these level flight tests were made at too great an altitude the range of Mach numbers would be unduly limited. An altitude of 20,000 feet was chosen.

7.1 Flight tests to measure loads in level flight

Tail loads were recorded in level flight over a range of subsonic speeds at 20,000 feet. Records were taken while the aircraft was accelerating at full throttle, from near its minimum speed to near its maximum, and then decelerating again with the throttle closed. This took approximately 8 minutes. The actual loads are of interest, and so also is the assessment of the stability of the shear bridges under the varying temperature conditions experienced in each run. This assessment can only be made for the shear bridges, since the loads over most of the speed range were too small to be determined by the tailplane mounting bridges, because of the hinge blocks' insensitivity to small loads. The shear loads were recorded in two flights with different aircraft weights and centre of gravity positions. In all records the aircraft normal acceleration was virtually 1 g "total", so no corrections for inertia load were required. Each reading

was first corrected, on the basis of the load indicated at 200 knots during the acceleration phase, and of the changes in skin temperature from this condition, by the methods described in section 6.1. A further small correction, 60 lb at the largest, was applied to each reading to allow for the change in aircraft weight and centre of gravity position from the 200 knot conditions.

The loads measured in the two flights, and the effects of the corrections, are shown in Figs.13a and 13b. It can be seen from these figures that, although corrections have been applied for temperature sensitivity, the rate of drift of the shear bridges is up to 400 lb per minute. In these two flights it appears that the general agreement between the loads measured by any one bridge during the acceleration and deceleration phases would have been better if no correction for drift with temperature had been applied. This may be because the corrections were determined under nearly stabilised temperature conditions, while in these two flights, and most of the others, loads were in fact measured under transient temperature conditions with additional thermal strains in the structure.

The loads shown in Figs.13a and 13b are virtually independent of Mach number below $M = 0.7$. This Mach number represents 200 knots equivalent air-speed at 40,000 feet, which justifies the use of the load indications in level flight at 200 knots to assess the drift of the shear bridges (sections 5 and 6.1), since these drift readings were only taken at altitudes up to 40,000 feet.

The position of the aerodynamic centre of the wings plus that part of the fuselage ahead of the shear gauges has been calculated, from the loads plotted in Figs.13a and 13b, and is presented in Fig.14.

7.2 Flight tests to measure loads in pitch-ups

Pitch-ups were entered at a range of Mach numbers from $M = 0.7$ to $M = 0.93$, at a nominal altitude of 35,000 feet. Two centre of gravity positions were used during the tests, the mean positions in flight being 1.5 inches aft of datum (i.e. at $25.3\% \bar{c}$) and 7.8 inches aft of datum (i.e. at $30.3\% \bar{c}$). These were associated with aircraft weights of 15,500 lb and 14,700 lb respectively. To initiate the pitch-up, the pilot pulled into a turn and maintained Mach number approximately constant while increasing normal acceleration until the pitch-up occurred. At the lower Mach numbers the pitch-up was entered in a turn at constant altitude; at the higher Mach numbers it was necessary for the aircraft to be put into a dive as the turn was entered, in order to avoid excessive speed loss. Two different techniques were used in the recovery:-

(a) Pushing out when the pitch-up started - this normally meant a slightly longer delay than in recovering from an incipient accidental pitch-up.

(b) Delaying the push-out to allow the pitch-up to develop fully.

Under the most severe conditions tested the aircraft would pitch-up to a maximum normal acceleration of approximately 6.5 g "total". These conditions occurred at $M = 0.93$, which was the highest Mach number used. At

higher Mach numbers than this there was insufficient elevator power for a pitch-up to be initiated by the use of elevator alone, and a pitch-up could only have been achieved by using the variable incidence tailplane to trim into the turn.

The time history of a typical pitch-up at a Mach number of 0.9 is presented in Figs.15a and 15b. In this pitch-up recovery action was taken as soon as the pitch-up started. The corrections which have been applied to the indicated loads in order to obtain aerodynamic loads are shown. The break in the records between the times 9.7 and 10 seconds is caused by an instrumentation fault. The other breaks in the load records are produced by the trace identifying interrupter.

The main points of interest in the records are:-

(a) Comparison of load measurements by the different methods. The two shear bridges were in very close agreement on changes in load, so the analysis of only one (Shear 2) is shown. The time histories of the tail loads measured by both methods are shown in Fig.15a (with mean values plotted during buffeting). The very large inertia corrections that are involved in computing aerodynamic load from shear gauge measurements in this type of manoeuvre can be seen in graph 9 of this figure. The agreement between the air load on the tailplane as measured by the tailplane mountings (Fig.15a graph 10), and the air load on the tailplane plus rear fuselage as measured by the Shear 2 bridge, (Fig.15a graph 11) is within 400 lb, except during the period of buffeting. However, a large proportion of this 400 lb is due to a discrepancy between the two systems at the beginning of the manoeuvre, and the actual load changes measured during the manoeuvre are in closer agreement.

(b) Buffet loads on the tailplane. Fig.12 is a flight record of part of the buffet period, starting at a time of approximately 8.6 seconds. Fig.15b shows time histories of the load measurements during the period of buffeting, and the corrections applied to them for galvanometer dynamic response, as described in section 6.2. The overall tailplane buffet loads shown in Fig.15b graph 5 are considerably smaller than those on either hinge block individually, since the hinge buffet loads are in antiphase. Agreement between the levels of buffet measured by the two systems (Fig.15b graphs 5 and 6) is poor. However, as explained in Section 6.2, the loads determined are in neither case the true aerodynamic buffet loads, since they have not been corrected for inertia effects produced by fuselage bending. The loads plotted as "aerodynamic loads" therefore reflect the fuselage bending vibration that occurs during buffeting (the first fuselage bending natural frequency is approximately 14 cycles per second).

(c) Fuselage and tailplane incidence. The difference between the fuselage and tailplane incidences during the pitch-up shows that a very large downwash angle builds up at the tailplane. This downwash, and the oscillation of the tailplane incidence vane that also occurs during the pitch-up, indicate that the tailplane moves into the wake of the wing.

(d) Rolling oscillation. As the pitch-up develops a rolling oscillation builds up, with a maximum rate of 20 degrees per second. The steady rate of roll at the end of the record is the beginning of the recovery from the turn in which the pitch-up was entered.

The results obtained from pitch-ups at different Mach numbers at 35,000 feet are summarised in Figs.16-20. Pitch-ups were carried out at two centre of gravity positions, and with either immediate or delayed recovery action. The various test conditions are shown by different symbols in the figures, but, in general, any consistent differences due to centre of gravity position or type of recovery action are masked by the general scatter of the results. In Fig.16, which shows the maximum normal acceleration experienced in the different pitch-ups, it is perhaps possible to detect slightly higher levels of acceleration for the tests at an aft centre of gravity and with delayed recovery, but the effect is small.

Figs.17 and 18 present results on the overall aerodynamic loads recorded in the pitch-ups. Because of the drift of the shear bridges it has not been possible to use them to make an accurate comparison of the peak aerodynamic loads reached in different pitch-ups. The results are therefore presented as the range of aerodynamic load (i.e. maximum up load minus maximum down load) during each pitch-up, taking a mean during buffeting, and this range is plotted against Mach number in Fig.17 and against maximum normal acceleration in Fig.18. Since both shear bridges indicated virtually identical load changes, only the results from Shear 2 are presented. The maximum down load occurred as the pitch-up developed, and the maximum up load occurred during the recovery. Similar results on load ranges have not been extracted from most of the tailplane mounting records, since it was not considered that the very considerable amount of analysis required would have been justified. However, a few pitch-ups have been fully analysed, and the results are included in Figs.17 and 18. The maximum absolute aerodynamic load indicated by the tailplane mountings was -6,300 lb at $M = 0.93$.

The amplitude of the structural buffet loads, recorded in the different pitch-ups, has been determined for both the tailplane mountings and the fuselage shear gauges. The maximum buffet amplitudes, on hinge block, front lever and Shear 2 records, are plotted against Mach number in Figs.19a, b and c respectively. The peak loads that were measured at the tailplane mountings occurred during buffeting, and were -9,500 lb on a hinge block and +5,500 lb on the front lever. Not all pitch-ups yielded both tailplane mounting and fuselage shear results. The quality of the records was such that it was not always possible to analyse the tailplane mounting loads, because of the rapid trace movements during buffeting. No shear results are available from the pitch-ups in the early part of the flying programme, since, although the bridges were attached to the aircraft, they were not at that stage connected to the recorder.

The downwash angle, as measured by the tailplane vane during pitch-ups, is plotted against fuselage incidence in Fig.20. This vane was carried on a boom attached to the tailplane at approximately mid-semispan. It was ahead of the tailplane by approximately one third of the horizontal distance between the local tailplane leading edge and wing trailing edge. It will be seen that, if the direction of flow at the vane position represents approximately the mean flow direction ahead of the tailplane, then the tailplane effectiveness falls off rapidly above a fuselage incidence of 5° . This type of result is to be expected on a swept-wing aircraft with a high tailplane, such as the Hunter, where the tailplane moves into the downwash field of the wing as the

incidence increases. The shape of the curve at the lower incidences at $M = 0.9$ suggests the passage of a shock wave over the tail vane. Ref.8 presents results from low-speed wind tunnel tests on a Hunter model. Mean downwash angle at the tailplane position, plotted against incidence, is presented in that report, and the curve is reproduced in Fig.20 of this note. It will be seen that, although there is reasonable agreement between the flight and tunnel results at fuselage incidences up to about 5° , there are large differences at high incidences. However, the tunnel results are the mean downwash at the tailplane position, measured by the tailplane setting for zero pitching moment contribution, while the flight results are the flow direction at the wind vane position. The difference between the two results at high incidences may therefore be a measure of the three dimensional nature of the flow in that region.

7.3 Flight tests to measure loads in transonic dives

Transonic dives were entered at approximately 45,000 feet; the pilot pushed over into the dive and then maintained a steady dive angle until recovery was initiated. The air brake was not used in this manoeuvre, and this particular aircraft was limited to 450 knots equivalent airspeed.

Typical results obtained shown in Fig.21. The main points of interest are:-

(a) In this particular dive the agreement between the Shear 1 and Shear 2 bridge results is very close; however, in some records there is an approximately constant difference of up to 500 lb between them after all corrections have been applied. This discrepancy is probably due to drift that occurred, between taking the record at 200 knots to establish the shear gauge datums, and the commencement of the transonic dive.

(b) Until 35 seconds from the start of the dive the tail mounting gauges indicate approximately 1,000 lb more aerodynamic down load than the shear gauges, and from this point on the difference increases to a maximum of 2,400 lb and then decreases again. It would appear that this increased difference is produced by incorrect starboard hinge loads, but a 2.5 inch lateral movement of the tailplane centre of pressure (in a span of 142 inches) could account for the difference between the port and starboard hinge loads. Other dives show similar discrepancies.

Throughout a series of dives the aerodynamic loads on the tailplane lay between +1,000 lb and -6,200 lb, if readings were taken from whichever measuring system indicated the maximum load.

8 DISCUSSION

8.1 Measuring techniques

The principal feature of the tailplane mountings used in these tests was the facility for in-flight determination of the strain gauge datums. The designs used functioned satisfactorily in this respect, but the experiment was compromised by the hinge blocks' load measuring performance, since their calibrations showed hysteresis and other non-linearities. These effects were probably caused by friction between the two components of the hinge block, which was thought to be due to some misalignment when they were fitted to the

aircraft, although none was readily apparent. The tailplane mountings also suffered from fairly rapid datum drift, which limited the measuring period available between datum checks. This drift was presumably due to temperature sensitivity of the bridges, and was particularly marked for the hinge blocks, where the gauges for each bridge were attached to two separate pieces of metal. The high frequency performance, i.e. during buffeting, was inadequate, because of the hysteresis in the load calibrations. The accuracy was also reduced under these conditions by the recording system, since it was necessary to use very sensitive galvanometers having a low natural frequency, and the readings consequently required fairly large and somewhat uncertain corrections for the galvanometer dynamic response.

Rear fuselage shear gauges appeared to offer a ready method of tail load measurement on the Hunter. The bridges used were relatively insensitive to loadings other than vertical shear, and had nearly linear calibrations. However, they suffered from temperature sensitivity, and also showed considerable "random" drift which was probably due to thermal stresses in the skin. The effects of this drift were reduced by relating all loads to one standard flight condition, but the rate of drift was such that useful load indications could only be obtained for perhaps 30 seconds after this datum condition had been established. The high frequency performance of the shear gauges was expected to be considerably better than that of the hinge blocks, because of the much smaller hysteresis in the shear gauge calibrations. Although it was still necessary to use very sensitive galvanometers with a poor dynamic response, the corrections for this during buffeting were more easily and confidently applied than in the case of the tailplane mountings.

The problems of using both methods of load measurement were accentuated by the wide range in the magnitude of the loads it was desired to measure, and the low levels of strain involved under most flight conditions. The maximum loads on the tailplane mountings were approximately a quarter of their calculated ultimate strengths, so the levels of strain to be measured were adequate under these conditions. However in level flight the loads on the mountings were in the order of 1% of their ultimate strengths, and under these conditions the effects of hysteresis and other non-linearities in their calibrations were so large that the loads could not be measured. The levels of strain to be measured by the fuselage shear gauges were only about half as great as in the tail mountings, but the signals to be measured were similar because of the different bridge arrangement (four active arms instead of two). The hysteresis in the shear bridge calibrations was very small, and it was possible to apply corrections for datum drift, which in this case allowed even the small aerodynamic loads in level flight to be measured (with some assumptions).

In spite of the problems encountered with the tailplane mountings, it appears that, with refinements in hinge block design, this method could be a good one for measuring absolute tail loads. If sufficient space were available a suitable design might have a self aligning bearing, restrained in a chordwise sense by a drag link attaching it to the hinge block case, and with its vertical movement restrained by two strain gauged cantilevers on the principle of those used on the front lever in this note. The tailplane would be restrained in a spanwise sense by the outer case of the hinge block bearing

against a shoulder on the pivot shaft, as before. This arrangement should minimise the effects of friction and misalignment. It would have bridges with four active arms and the gauges mounted close to each other on a single piece of metal, giving the maximum output for a given strain and the most effective temperature compensation. In any design the gauged parts should have the maximum strain consistent with safety. If the flight conditions to be studied involve small loads only, it may well be necessary to use mountings with lower strengths than the standard ones, and to limit the aircraft's flight envelope accordingly.

Fuselage shear gauges, on the other hand, appear to offer a suitable method of measuring load changes, even at low levels of strain, but not of measuring absolute loads at the levels of strain encountered in the Hunter. The use of such gauges on an aircraft with similar levels of strain, but with greater engine or kinetic heating, would pose greater problems than those experienced here, due to increased datum drift.

Since the tailplane mountings needed six recording channels, while a fuselage shear bridge needed only one, considerably less data analysis effort was required for the latter system. The difference was particularly marked in any analysis of loads during buffeting.

The various strain gauge bridges measured structural loads, and it was necessary to apply inertia corrections to the readings if aerodynamic loads were required. These corrections were much larger for the shear gauges than they were for the tailplane mountings, since the total mass aft of the shear gauges was approximately three times that of the tailplane alone. If the aerodynamic loads on the tailplane alone were required it was necessary, in the case of the shear gauges, to allow for the aerodynamic load on the rear fuselage, and this was difficult to assess accurately at high incidences.

Vertical bending vibration of the fuselage occurred under buffeting conditions, but in the tests described in this note no attempt was made to allow for this. If true aerodynamic loads were required under these conditions, it would be necessary to take account of this vibration when calculating inertia corrections. A suitable accelerometer, fitted at the tailplane position, would give the measurements necessary to allow these corrections to be calculated for the tailplane mounting system, providing that the tailplane itself could be treated as rigid. However the analysis would require considerable computing effort. In the case of a shear gauge system it seems unlikely that these corrections could be determined accurately, because of the distributed mass and varying acceleration aft of the gauges. If, however, only the mean aerodynamic load is required during buffeting, then the shear gauge results can be readily analysed, and this analysis is considerably simpler and quicker than the corresponding analysis of tailplane mounting results.

8.2 Loads measured

Tail loads were measured in level flight, pitch-ups and transonic dives. The loads in level subsonic flight at 20,000 feet were small and could therefore only be measured using the shear gauges. These loads were virtually independent of Mach number below $M = 0.7$ (Figs. 13a and 13b). Above $M = 0.7$ an increasing down load developed, so that the tail load changed by -1,200 lb between

$M = 0.7$ and $M = 0.92$ (the maximum Mach number of these tests). Fig. 14 shows the variation with Mach number of the position of the aerodynamic centre of the wing and that part of the fuselage ahead of the shear gauges. It remains virtually constant at about $28\% \bar{c}$ up to $M = 0.7$ and then moves back until it has reached about $40\% \bar{c}$ by $M = 0.92$.

During a series of pitch-ups at 35,000 feet the maximum aerodynamic load recorded by the tailplane mountings (taking a mean during buffeting) was -6,300 lb at $M = 0.93$. The contribution of the aerodynamic load to the total load measured by the shear gauges was, in all cases, considerably smaller than the contribution of the inertia load. The maximum ranges of the buffet loads on the hinge blocks and front lever were respectively 12,700 lb and 2,500 lb peak-to-peak. The maximum loads on the hinge blocks and front lever were recorded during buffeting and were -9,500 lb and +5,000 lb respectively.

Throughout a series of transonic dives the aerodynamic loads on the tailplane lay between +1,000 lb and -6,200 lb.

The Hunter tailplane was designed for a fully factored load of 20,750 lb, and a structural test specimen has been subjected to this without failure. The strengths of the standard Hunter hinge block and front lever are at least 25,000 lb and 17,300 lb respectively, as indicated by ground tests. The maximum tailplane loads that have been recorded in the present tests are therefore well below the structural strength limitations of the aircraft. The possible errors in the load measurements in this note are in the order of ± 500 lb, and may well be considerably more in the case of the hinge blocks.

9 CONCLUSIONS

Two strain gauge methods of measuring the loads on the tailplane of a Hunter aircraft have been assessed in flight.

One system used modified tailplane mountings with an in-flight datum measuring facility. This datum measuring system worked well, and thus partly overcame the major problem of drift which arises when strain gauges are used for absolute load measurement. However, the design of hinge block used gave calibrations with large hysteresis and other non-linearities, and also suffered from fairly rapid drift.

The other measuring system used rear fuselage shear gauges. Those gave reasonable calibrations, but suffered from temperature sensitivity, and also "random" drift which was probably due to thermal stresses in the structure.

The problems of using both systems were accentuated by the low levels of strain it was necessary to measure under most flight conditions. Although the maximum strain in the modified tailplane mountings was relatively high in the tests described here, the difficulties encountered emphasise that if such parts are made for other tests, they should be designed so that the strain in them under the flight conditions being studied is as high as possible, consistent with safety.

Although neither method proved to be really satisfactory in these tests, it appears that both of them offer promise of success. In general, if the

tail loads on an aircraft are required, and both the methods used here are applicable, the following points must be considered when deciding which to use:-

(a) Fuselage shear gauges appear to offer the simplest method of measuring load changes over a period of perhaps 30 seconds.

(b) Modified tailplane mountings should allow absolute loads to be determined, over the length of time necessary for any normal manoeuvre, but require appreciable design and manufacturing effort.

(c) Measurements from tailplane mountings require several times as much data reduction effort as measurements from shear gauges.

(d) Both systems measure structural loads, which represent the sum of aerodynamic and inertia loads. The inertia corrections required, to obtain aerodynamic loads under manoeuvring conditions, are considerably larger for shear gauges than for tailplane mountings. In the case of shear gauges it is also necessary to allow for the aerodynamic load on the rear fuselage, and this may be difficult to assess.

(e) Both systems will give structural loads under buffet conditions. Mean aerodynamic loads under these conditions can readily be obtained from shear gauges. However, if actual aerodynamic buffet loads are required, these can possibly be obtained from tailplane mountings, but not from shear gauges.

In the tests described in this note tailplane loads have been measured in level subsonic flight at 20,000 feet, pitch-ups at 35,000 feet and transonic dives limited to 450 knots equivalent air speed. The various difficulties encountered limited the accuracy of load determination, but reasonable agreement on incremental changes in aerodynamic load over short time intervals (less than 30 seconds) was obtained. In all cases the maximum loads measured were well below the structural limitations of the aircraft.

LIST OF REFERENCES

| <u>No.</u> | <u>Author</u> | <u>Title, etc.</u> |
|------------|--|--|
| 1 | Sadoff, M. | Flight measurements of the horizontal-tail loads on a swept wing fighter airplane at transonic speeds. NACA/TIB/3933. N.A.C.A. R.M. A53G10 November 1953. |
| 2 | Skopinski, T.H. Aiken, Jr, W.S. Huston, W.B. | Calibration of strain-gauge installations in aircraft structures for the measurement of flight loads. NACA/TIB/3420. Superseded by N.A.C.A. Technical Note 2993. August 1953. |
| 3 | Krause, N.A. | Strain gauge calibrations and flight loads testing techniques. A.G.A.R.D. Report 113. May, 1957. |

LIST OF REFERENCES (Contd.)

| <u>No.</u> | <u>Author</u> | <u>Title, etc.</u> |
|------------|--|--|
| 4 | Wood, J. Tiffany, A. | Precision strain gauge techniques. A.R.A. Wind tunnel Note No.22. March 1958. |
| 5 | Andrews, D.R. Nethaway, J.E. | Flight measurements of the pressure errors of a nose and a wing boom airspeed system on a swept-wing aircraft (Hunter F, Mk.1) at Mach numbers up to 1.2. Unpublished M.O.A. Report |
| 6 | Foster, G.V. Griner, R.F. | A study of several factors affecting the stability contributed by a horizontal tail at various vertical positions on a sweptback-wing airplane model. NACA/TIL/2212. Superseded by N.A.C.A. Tech.Note 3848. November 1956 |
| 7 | Weber, J. Kirby, D.A. Kettle, D.J. | An extension of Multhopp's method of calculating the spanwise loading of wing-fuselage combinations. ARC R & M 2872. November, 1951. |
| 8 | Kirby, D.A. Holford, J.F. | Low speed tunnel tests on a 1/5th scale model of a single-jet fighter with a 40° sweptback wing (Hawker F3/48). Unpublished M.O.A. Report. |

TABLE 1

Aircraft data

Weight and centre of gravity

| | Weight | C.G. |
|--------------|-----------|-----------------|
| Forward C.G. | 15,500 lb | 25·3% \bar{c} |
| Aft C.G. | 14,700 lb | 30·3% \bar{c} |

Wing

| | |
|--|-------------------------------|
| Span | 33·67 ft |
| Total area | 340 sq ft |
| Aspect ratio | 3·33 |
| Aerodynamic mean chord | 10·65 ft |
| $\frac{1}{4} \bar{c}$ point | 0·10 ft aft of fuselage datum |
| Incidence with respect to fuselage datum | 1·5° |
| Dihedral angle | -1° |
| Sweepback at $\frac{1}{4}$ chord line | 40° |
| Thickness to chord ratio | 8·5% |

Tailplane

| | |
|---|--------------------------------|
| Span | 11·83 ft |
| Area | 53·92 sq ft |
| Aspect ratio | 2·60 |
| Aerodynamic mean chord | 4·83 ft |
| $\frac{1}{4} \bar{c}$ point | 20·27 ft aft of fuselage datum |
| Incidence with respect to fuselage datum variable | ±2·5° |
| Dihedral angle | 0° |
| Sweepback at $\frac{1}{2}$ chord line | 41·5° |
| Thickness to chord ratio | 8·0% |

Fuselage

| | |
|------------------------------|----------|
| Length (excluding nose boom) | 44·71 ft |
|------------------------------|----------|

Tailplane mountings

| | |
|--|----------|
| Distance between hinge centres | 0·825 ft |
| Distance between hinge line and jack attachment point on front lever | 2·415 ft |

Masses used in inertia calculations

| | |
|---------------------|----------|
| Tailplane mass | 360 lb |
| Mass aft of Shear 1 | 1,120 lb |
| Mass aft of Shear 2 | 1,090 lb |



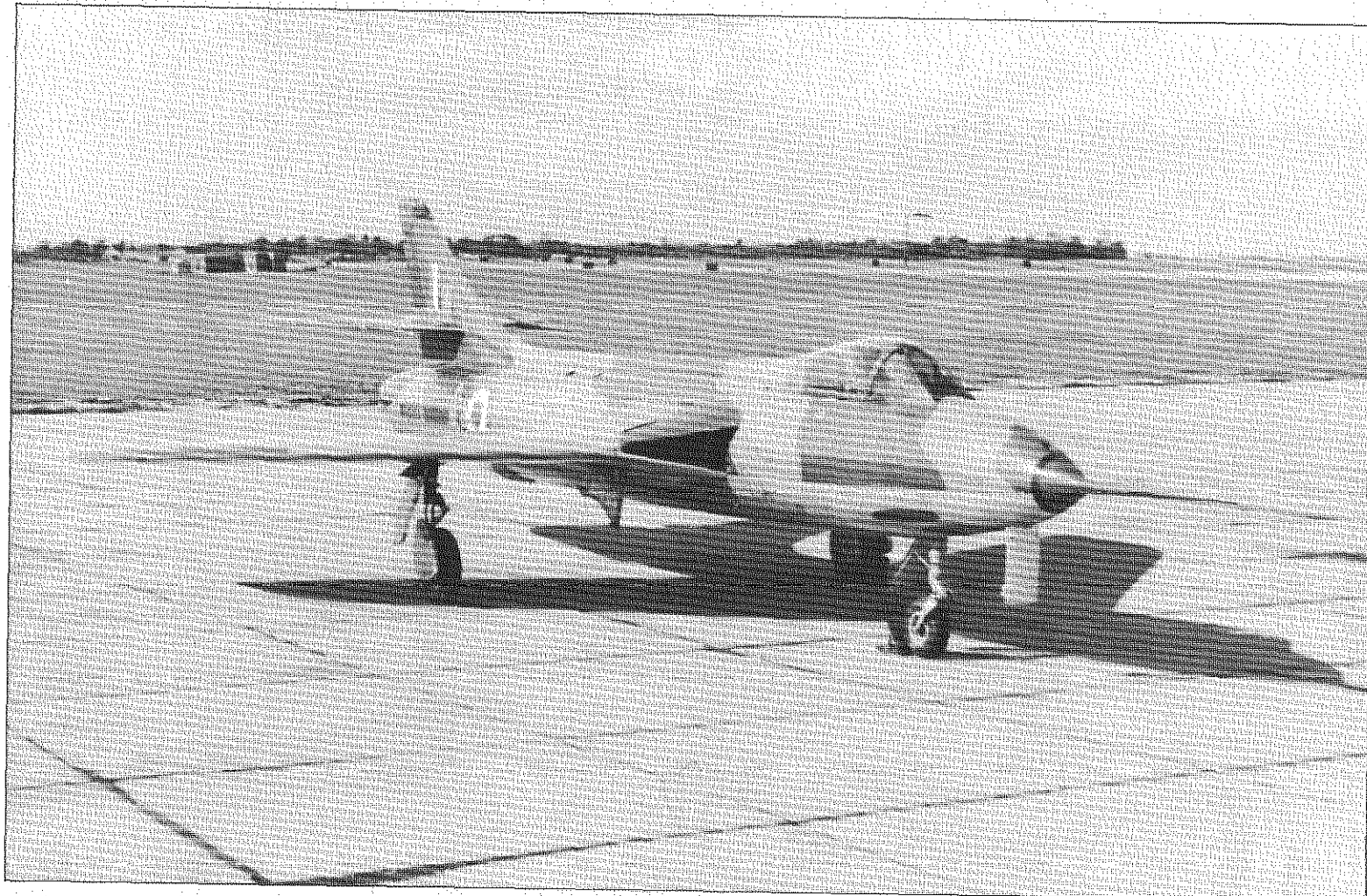

FIG.1. GENERAL VIEW OF HUNTER WN 893

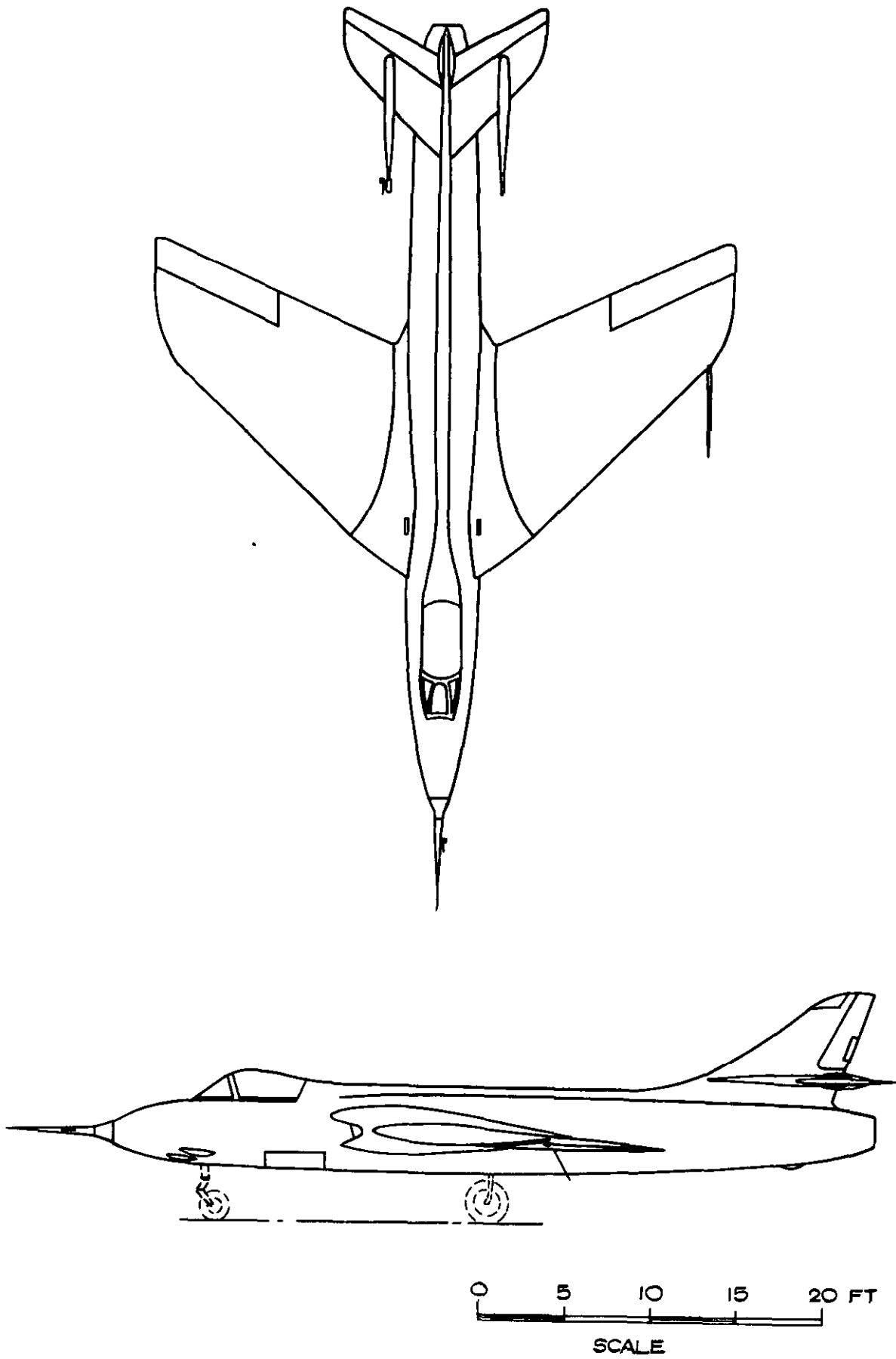

FIG. 2. HAWKER HUNTER F.2. (WN.893.)

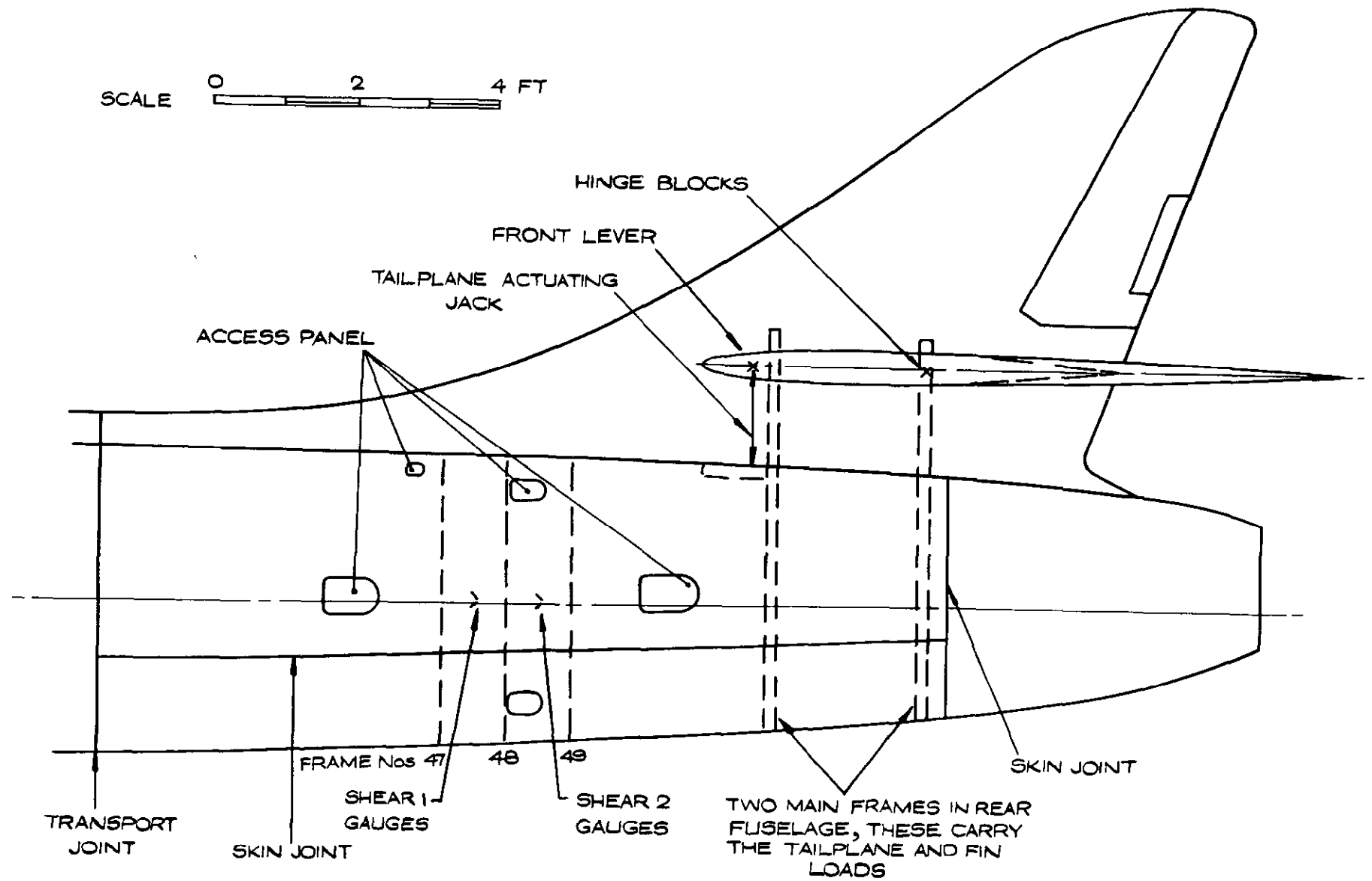

FIG. 3 DIAGRAM OF REAR FUSELAGE AND TAILPLANE OF HUNTER, SHOWING POSITION OF STRAIN GAUGES.

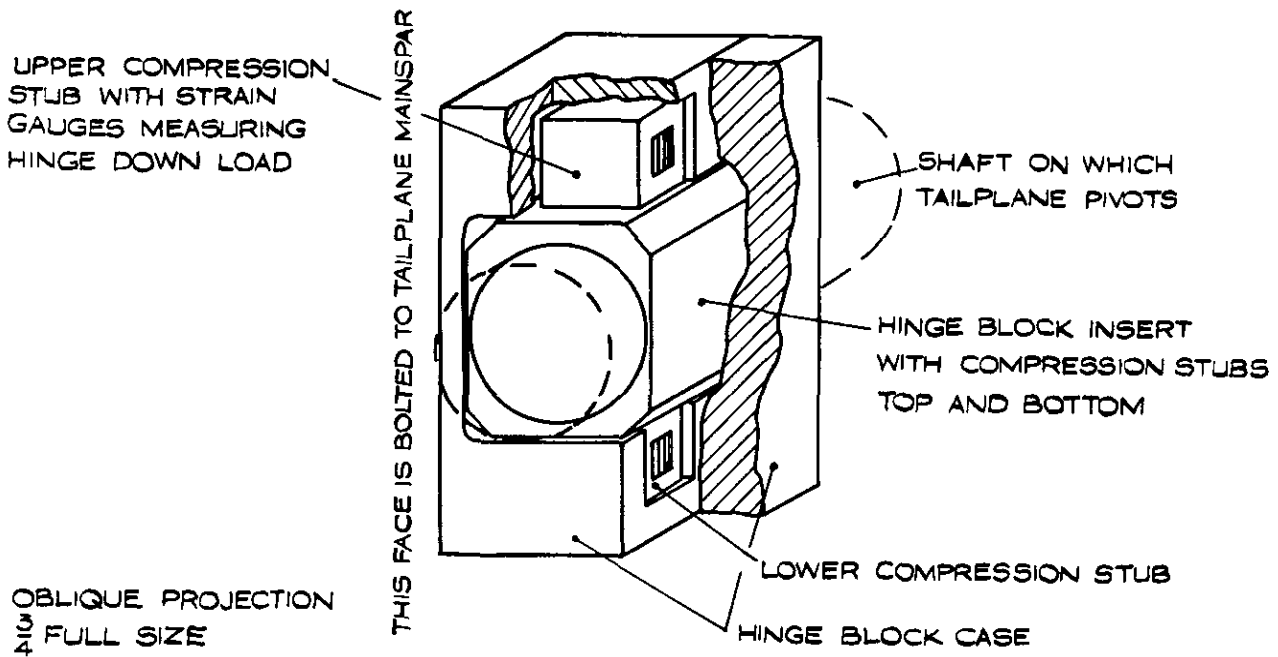

FIG 4(a) DIAGRAM OF HINGE BLOCK

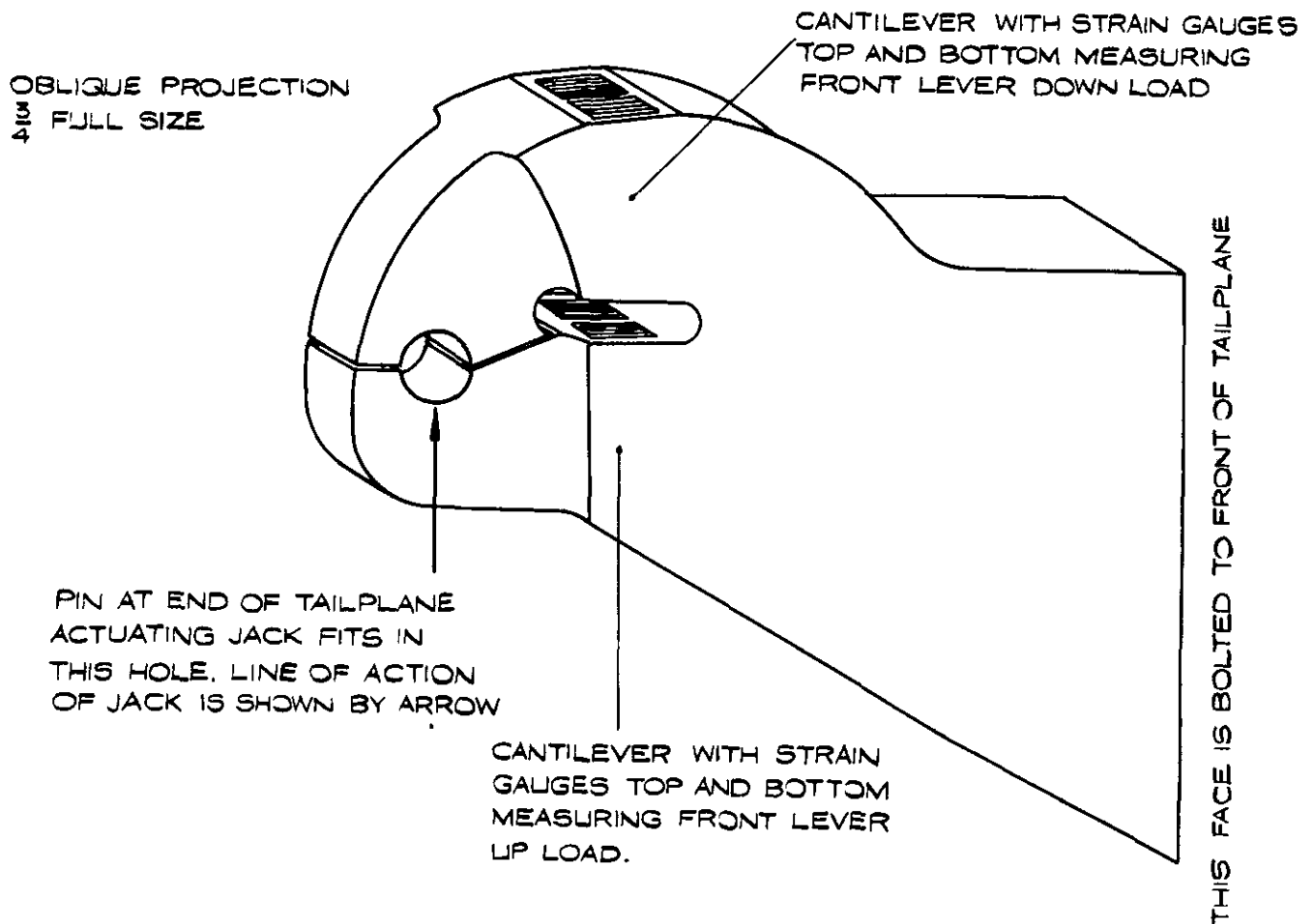

FIG. 4(b) DIAGRAM OF FRONT LEVER

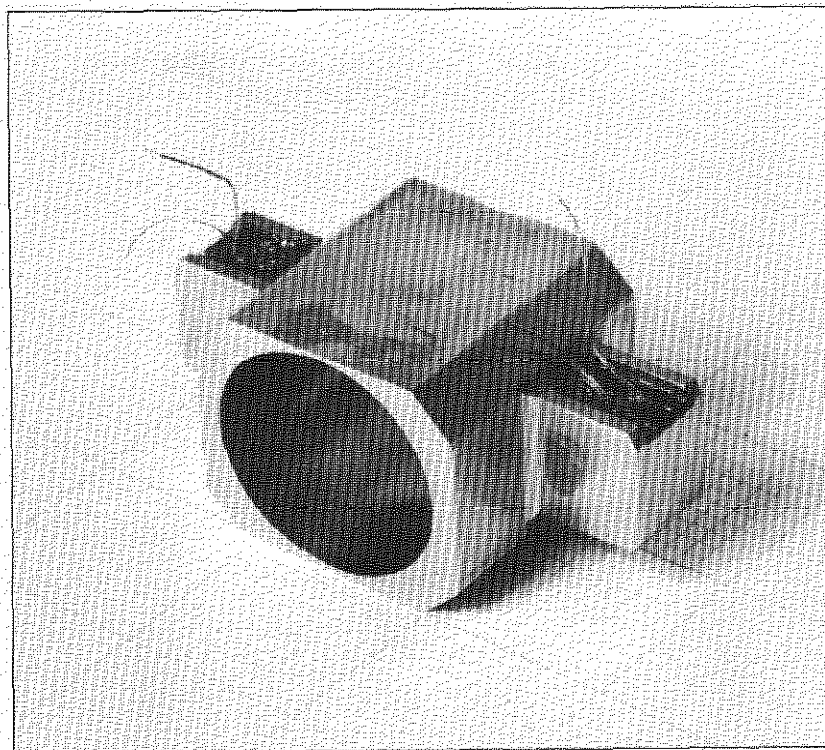

FIG.5a. HINGE BLOCK INSERT, SHOWING FRETTING WHICH OCCURRED IN USE

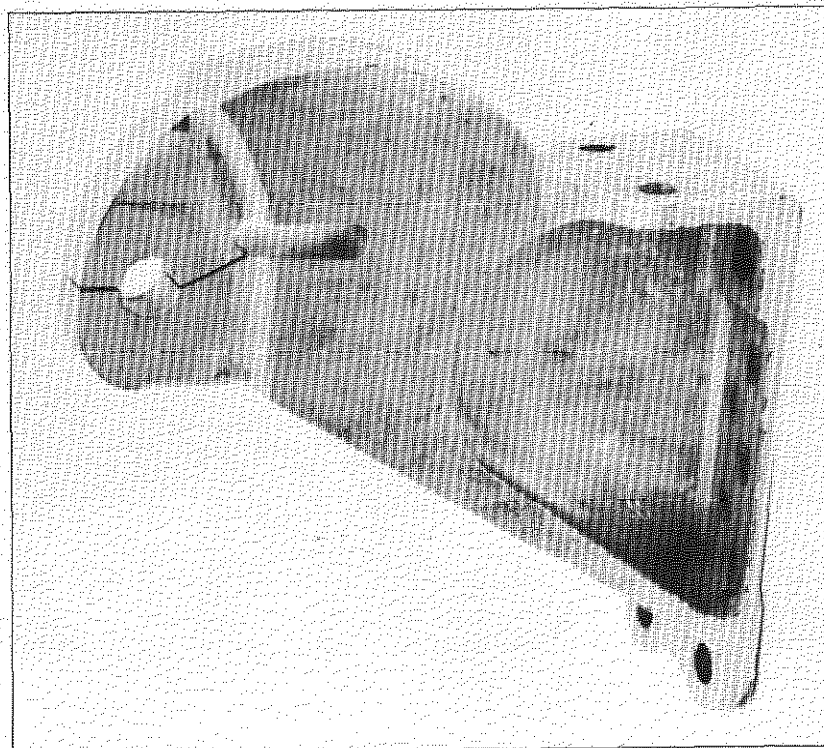

FIG.5b. FRONT LEVER, WITHOUT STRAIN GAUGES

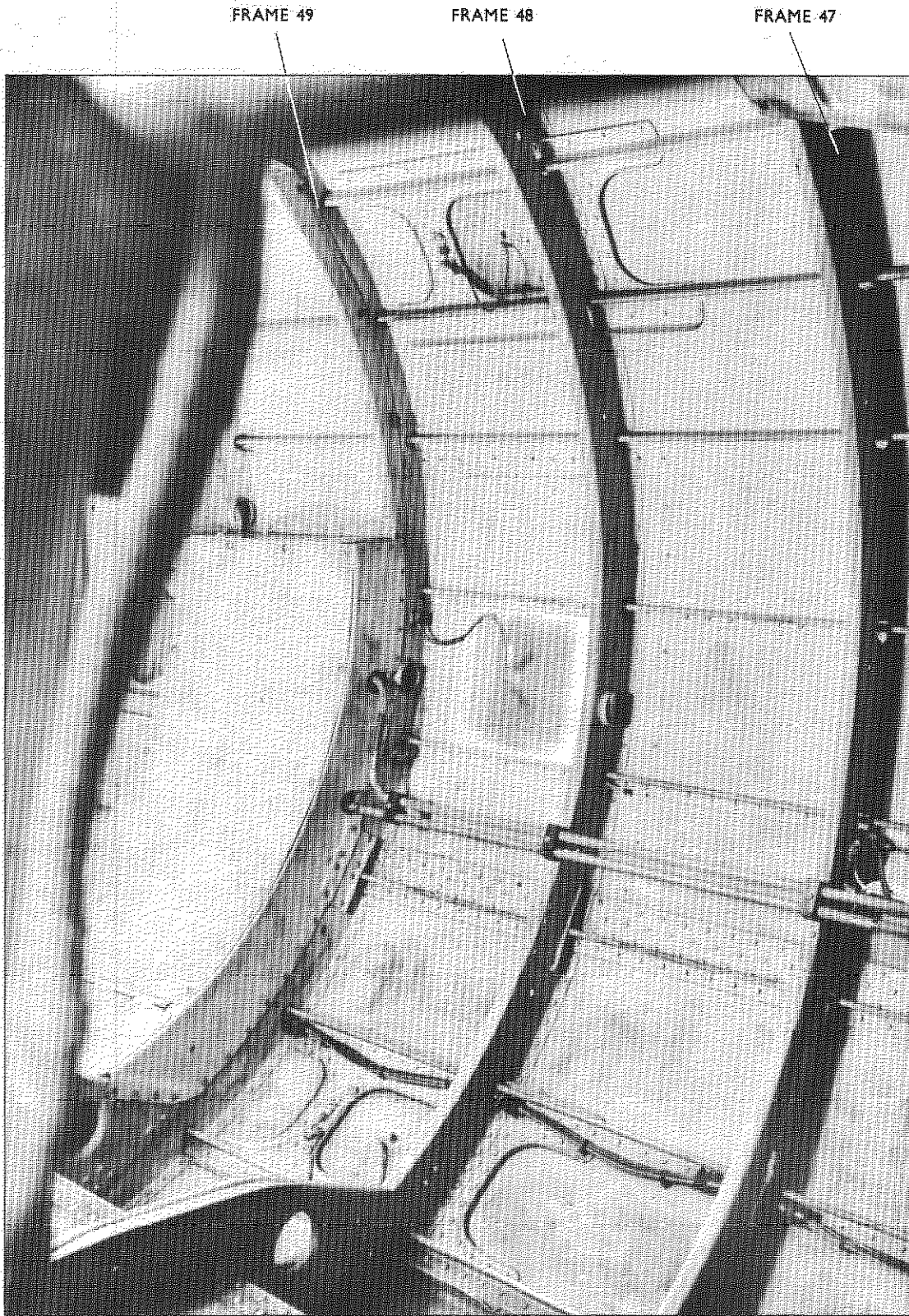

FIG.6. INSIDE OF REAR FUSELAGE, SHOWING THE
SHEAR 2 BRIDGE STRAIN GAUGES

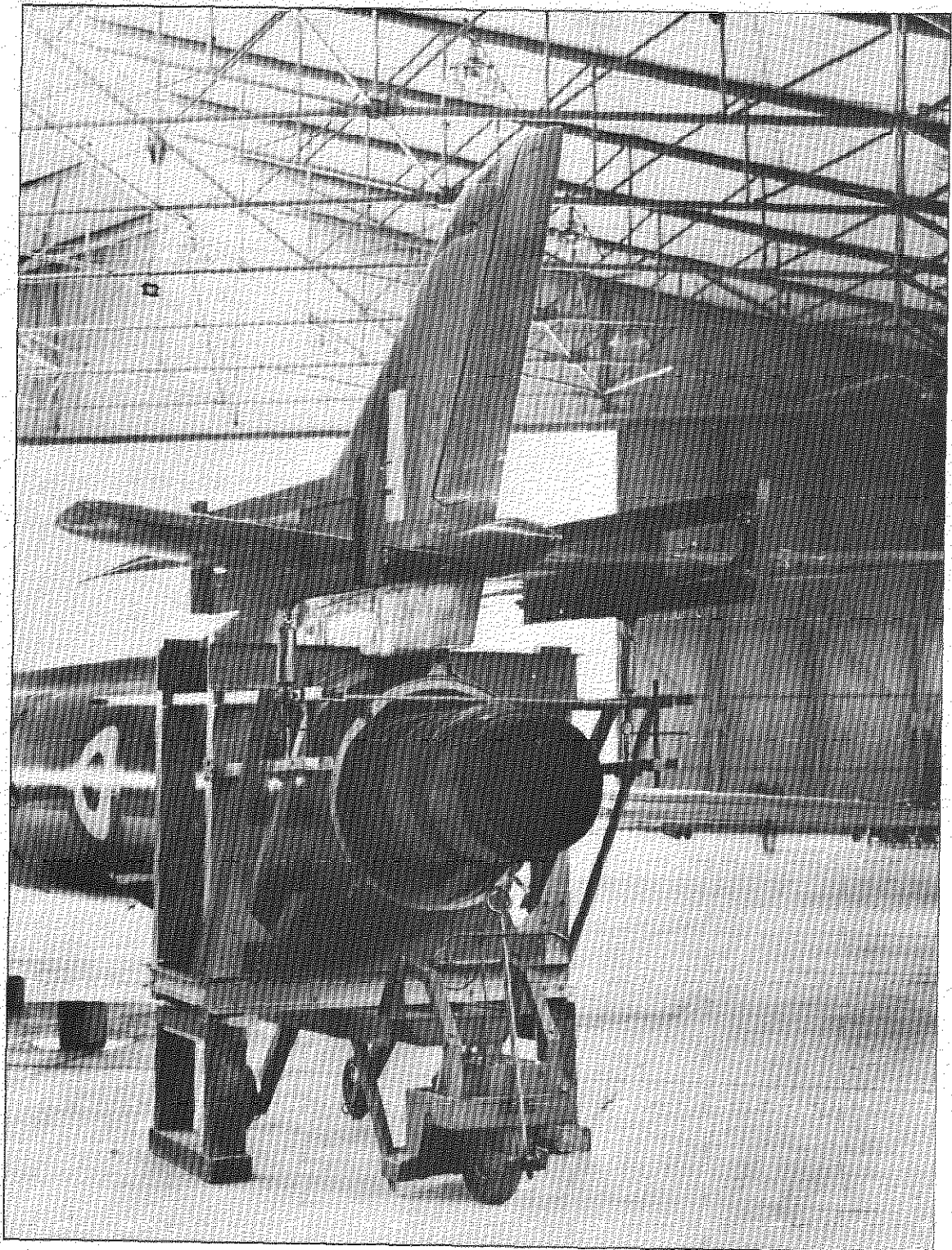

FIG.7. STRAINING RIG USED TO CALIBRATE
TAILPLANE MOUNTINGS

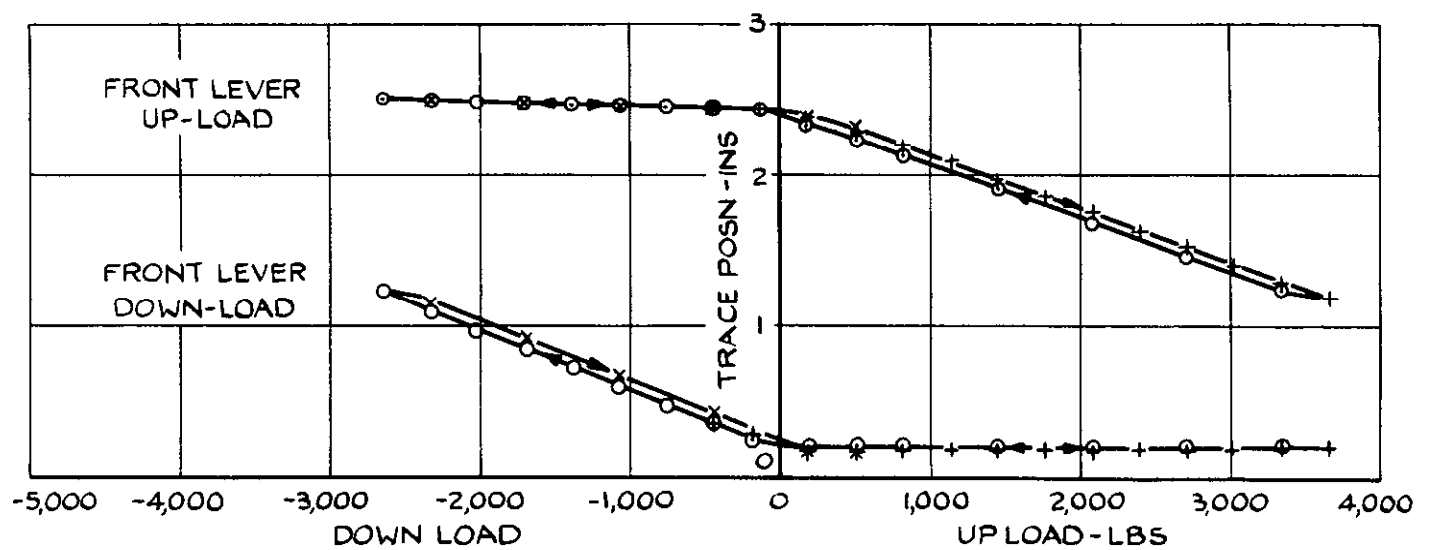
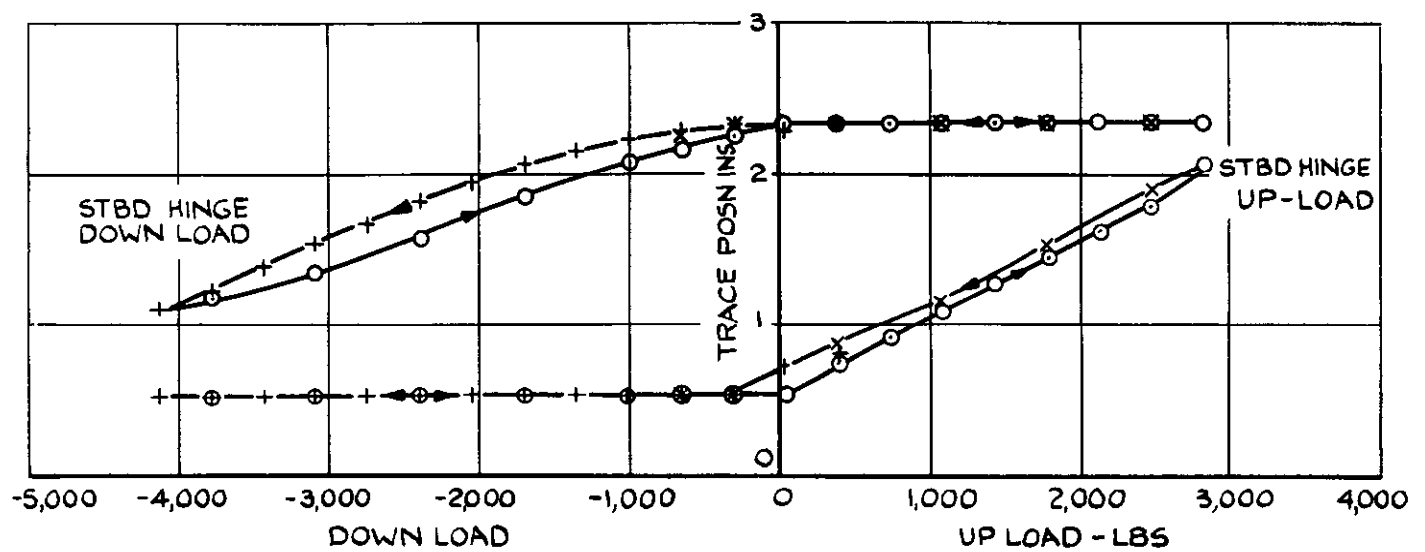
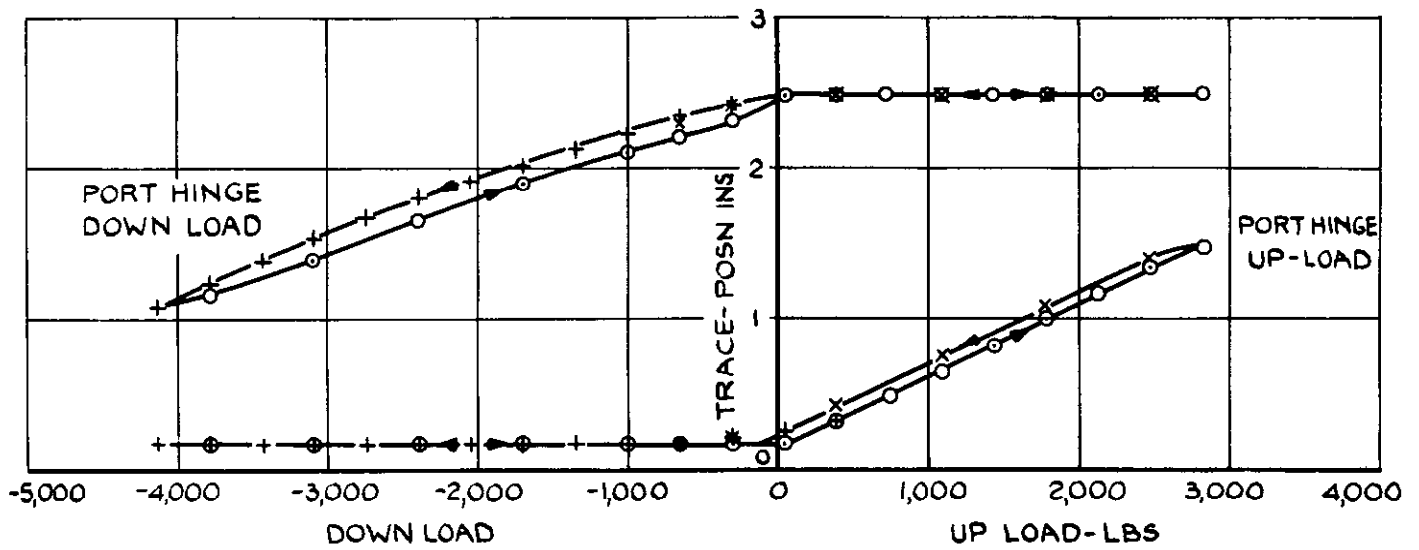

FIG. 8(a) CALIBRATIONS OF HINGE BLOCKS AND FRONT LEVER.

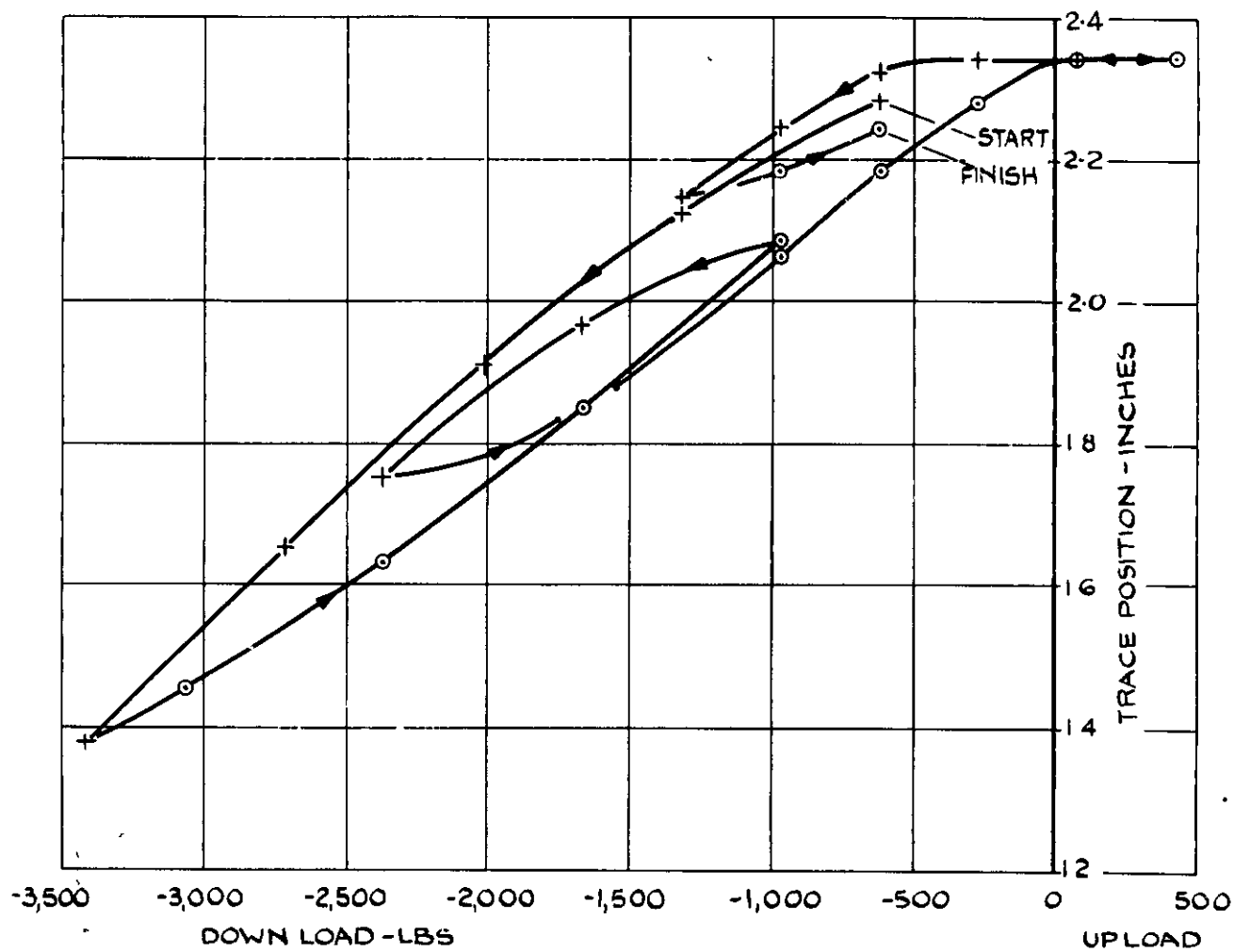

FIG. 8(b) STARBOARD HINGE DOWN-LOAD CALIBRATION TO SHOW HYSTERESIS EFFECTS.

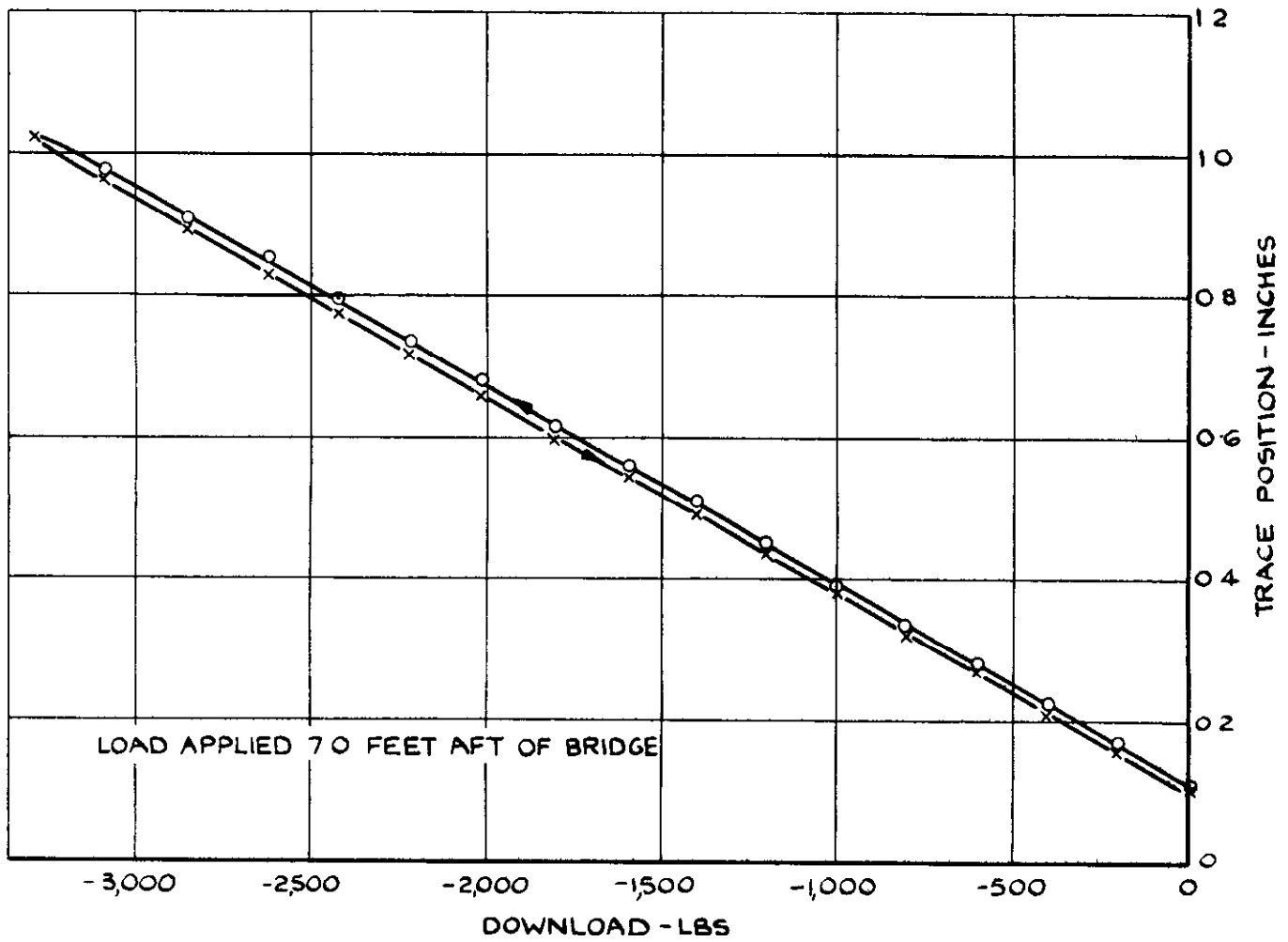

FIG 9 CALIBRATION OF FUSELAGE SHEAR | BRIDGE.

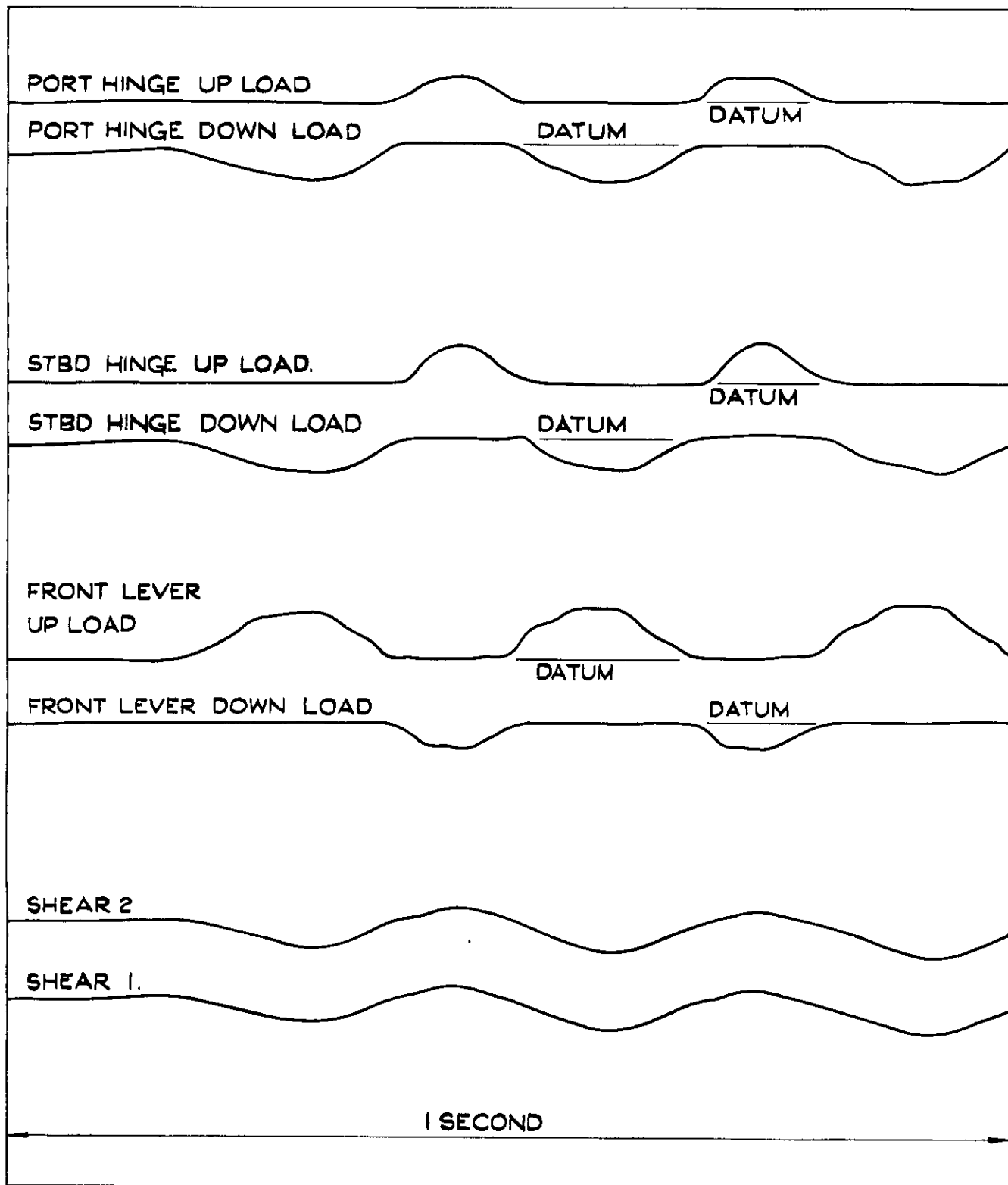

FIG. 10. TYPICAL LOAD RECORDS DURING IN-FLIGHT DATUM DETERMINATION.

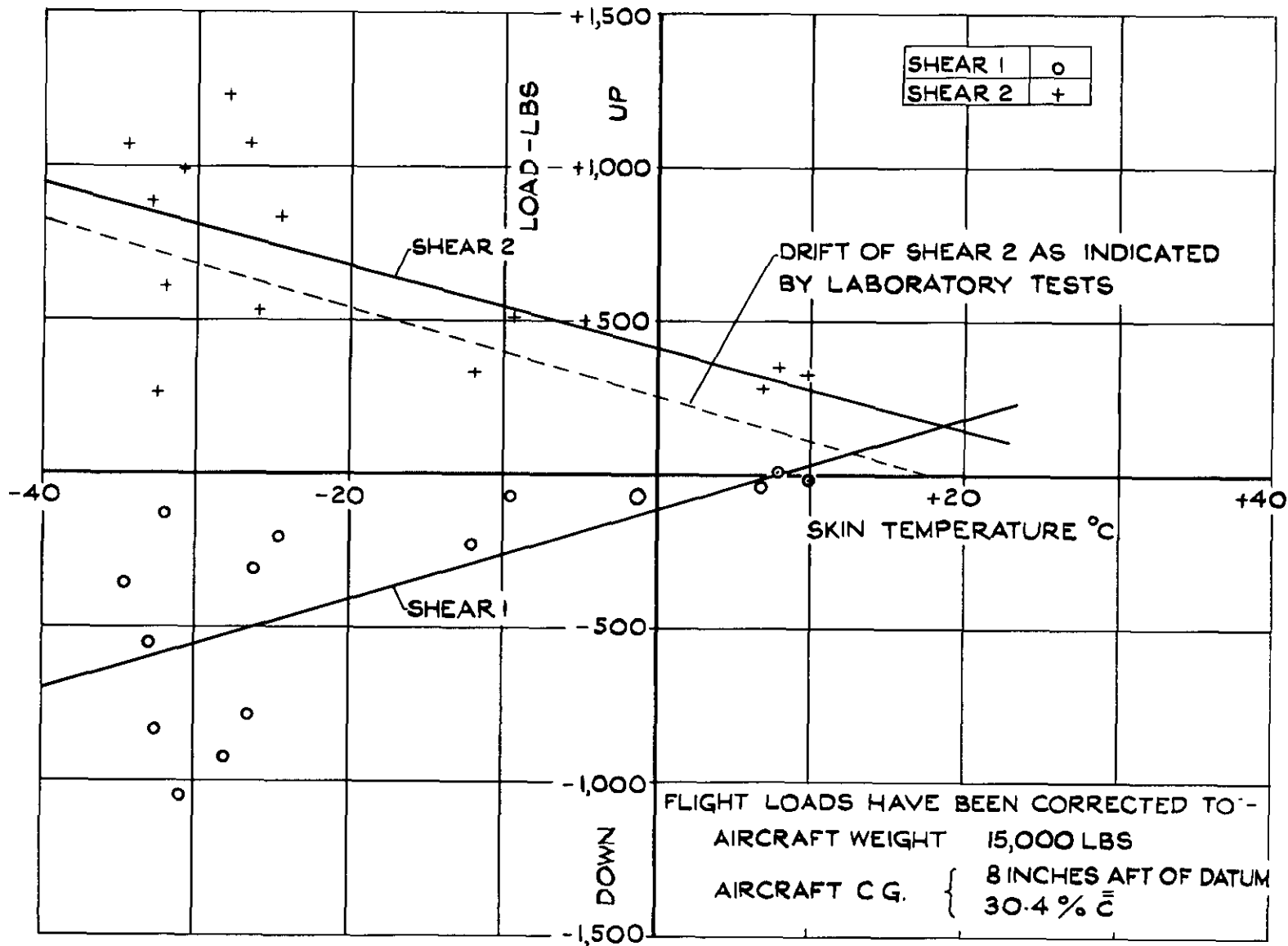

FIG. 11. LOADS INDICATED BY SHEAR BRIDGES IN LEVEL FLIGHT AT 200 KNOTS.

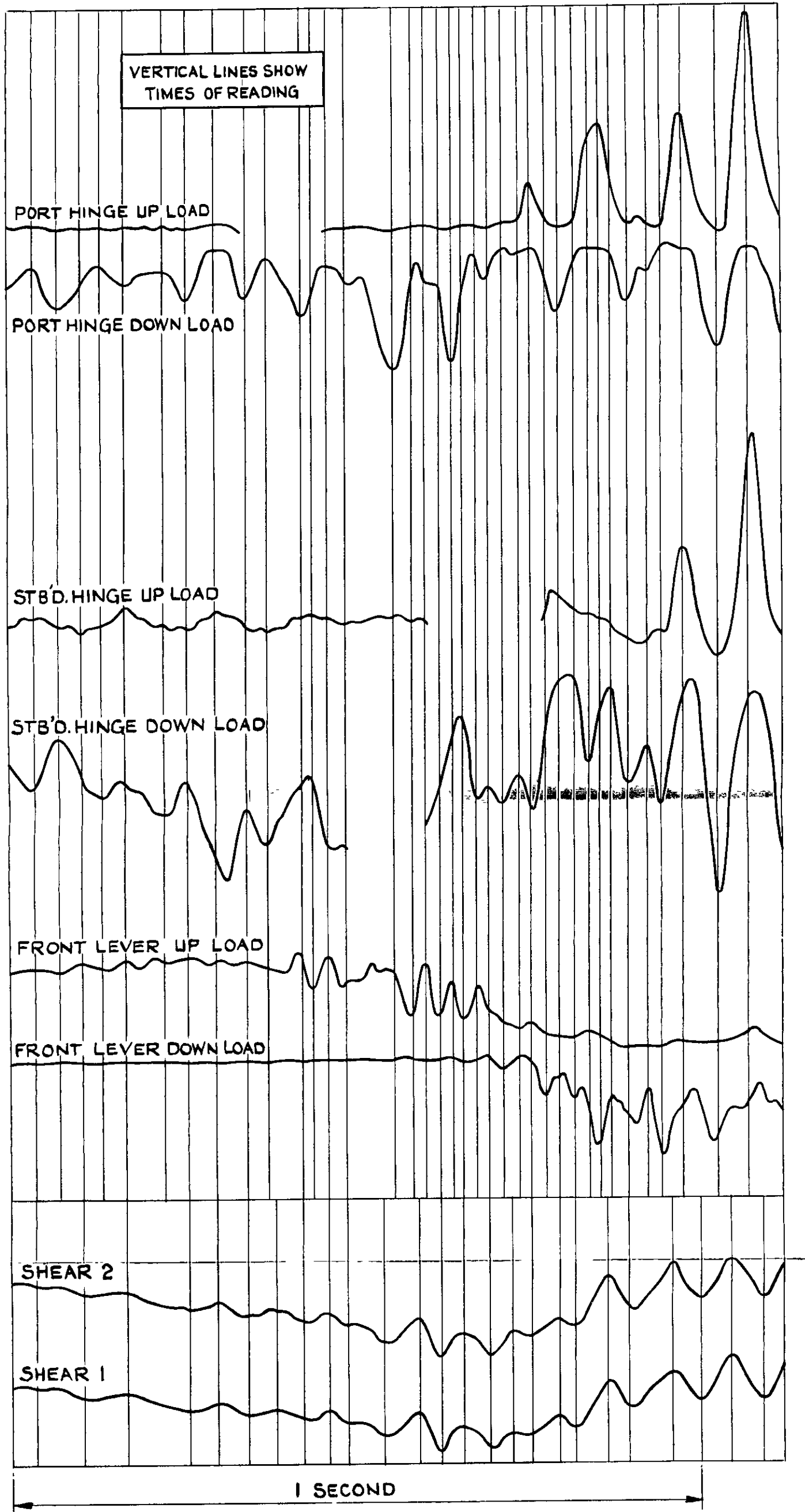
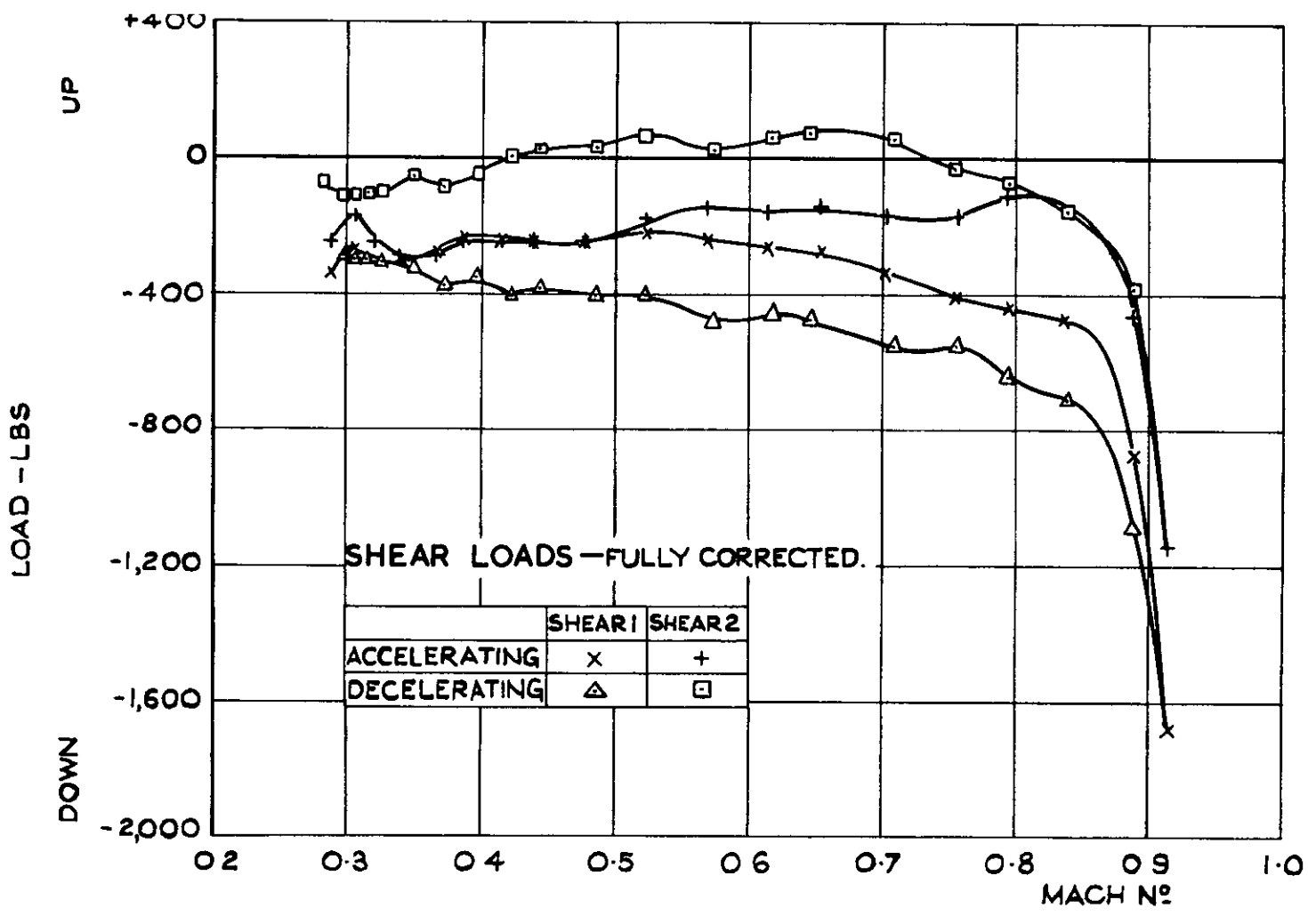
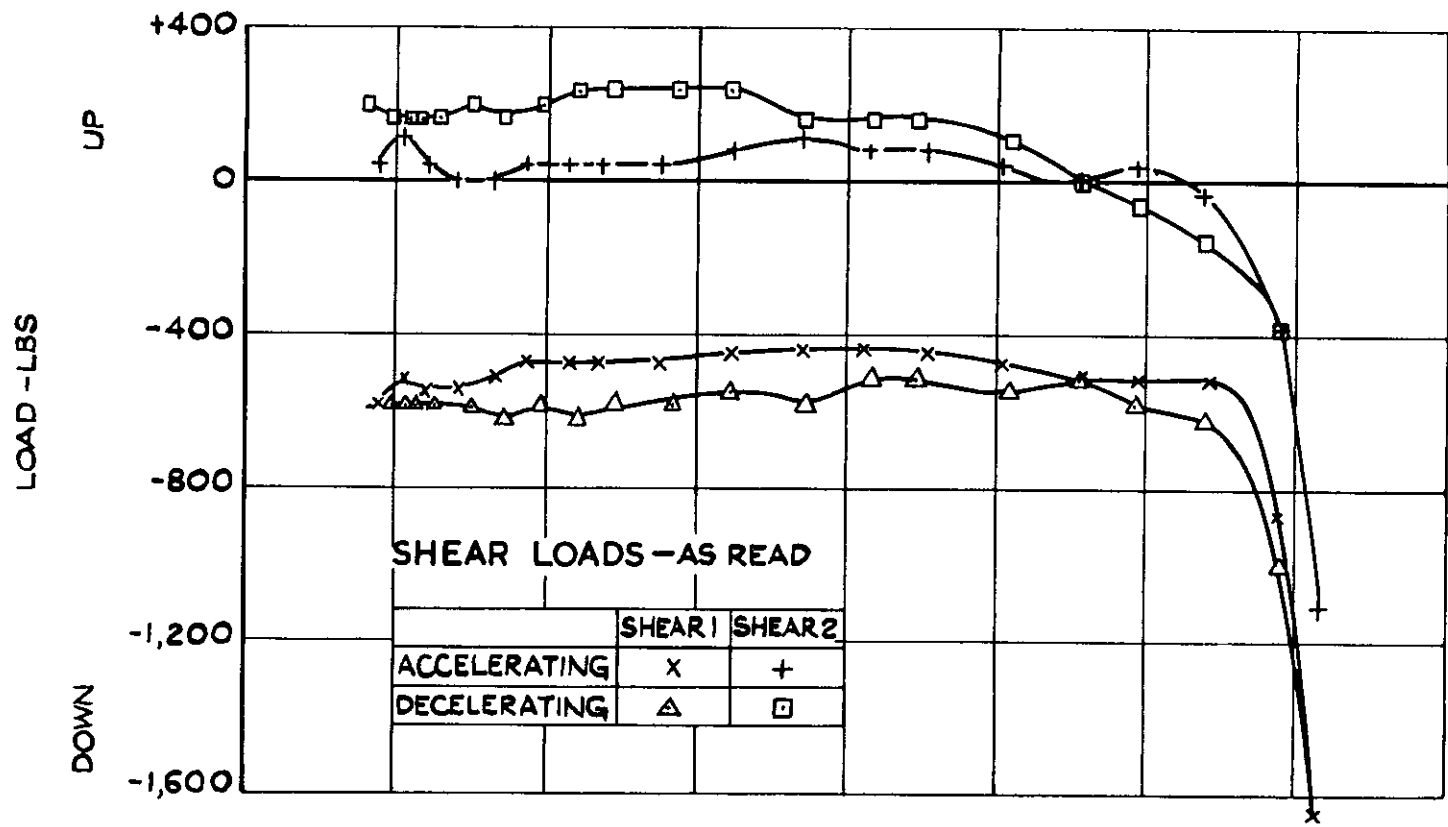
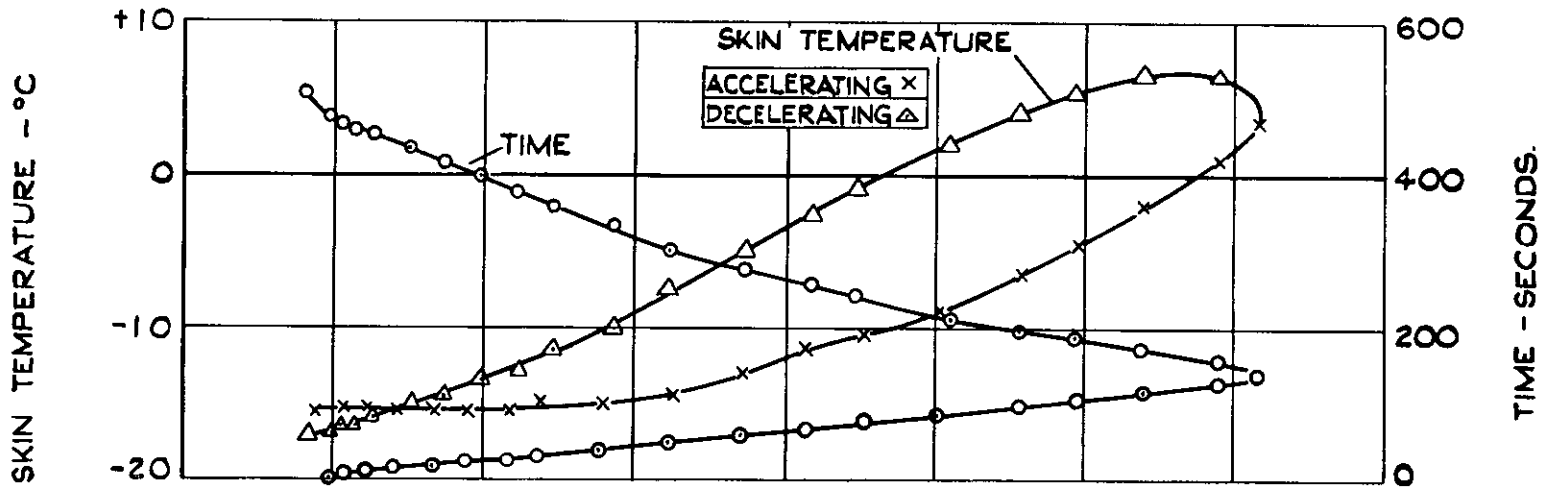
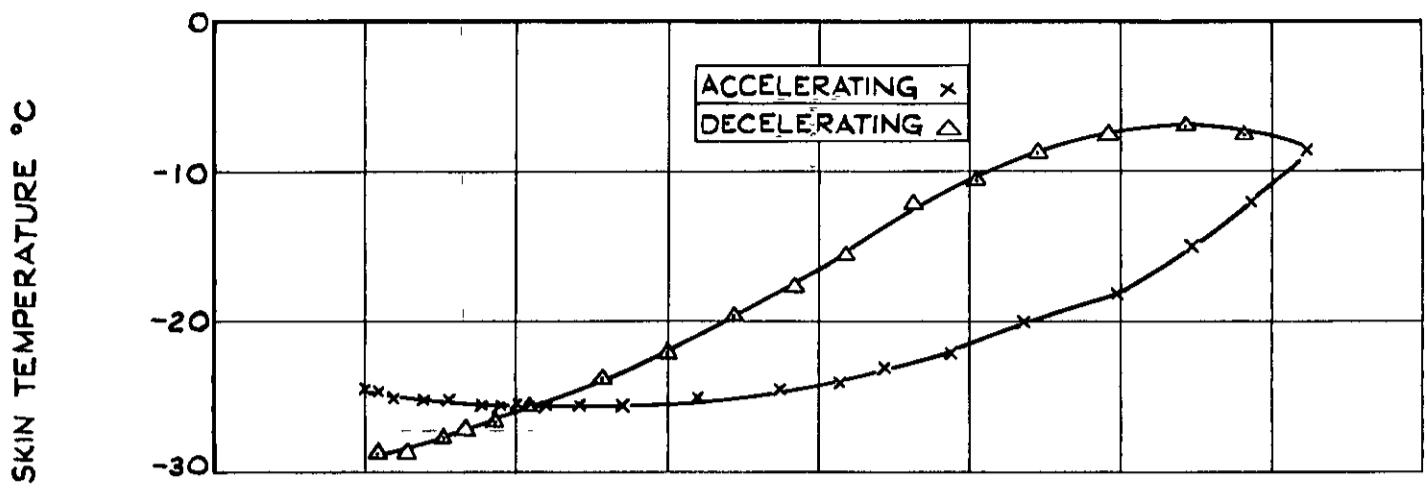

FIG.12. TYPICAL LOAD RECORDS DURING PITCH-UP BUFFET



MEAN WEIGHT 15,500 LBS.
MEAN C.G. 25.3% \bar{c} .

FIG. 13(a) LOADS MEASURED IN LEVEL FLIGHT AT 20,000 FEET - FORWARD C.G.



NO TIME RECORD OBTAINED

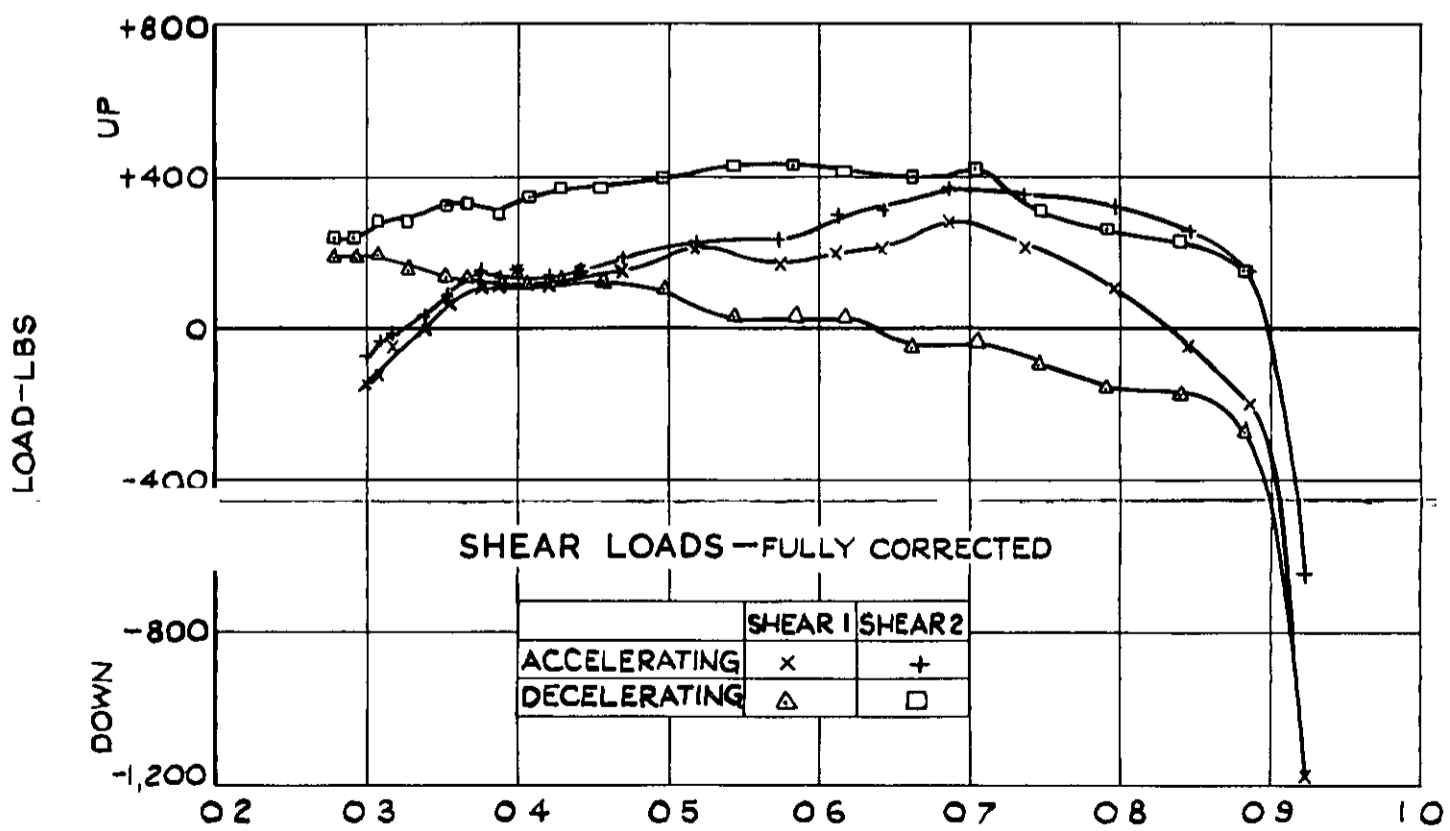
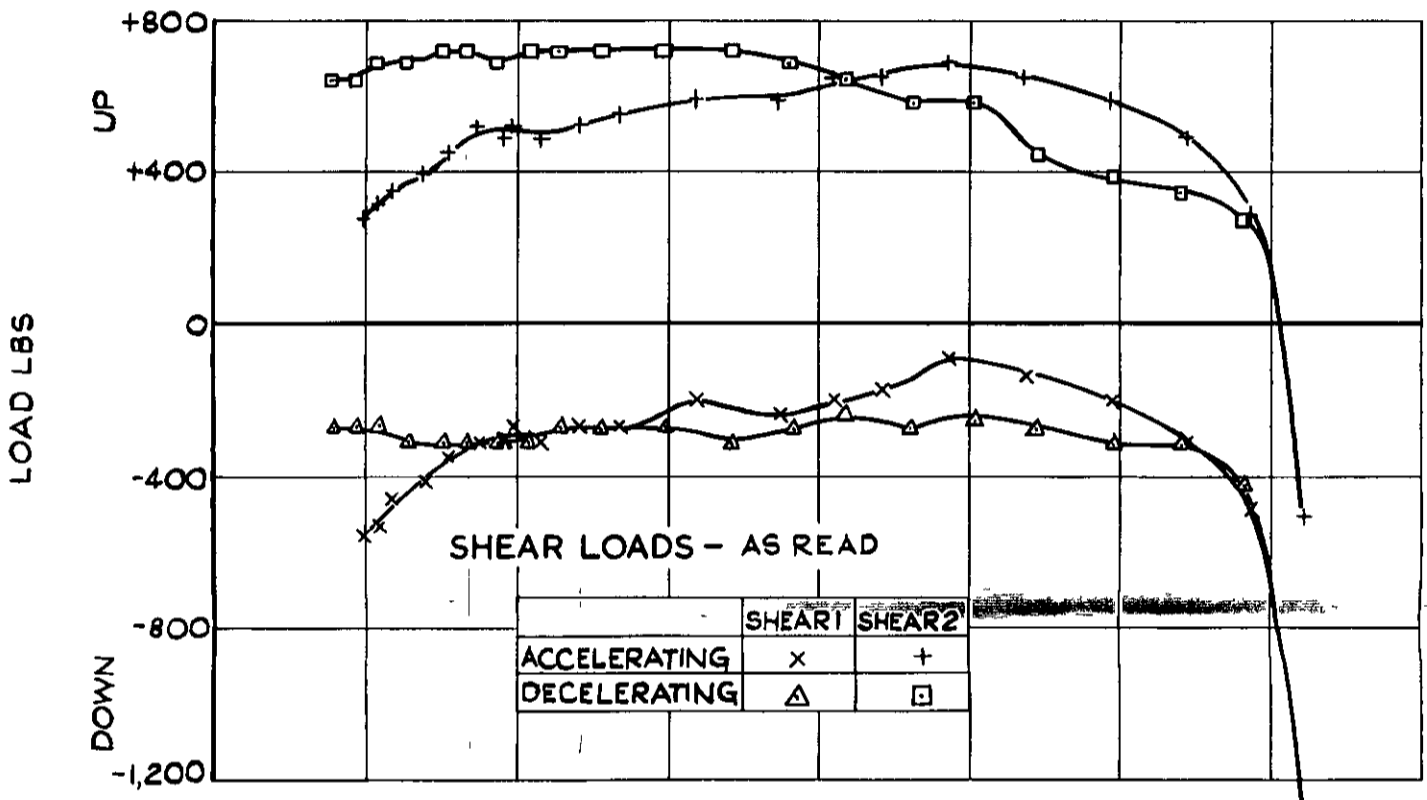

MEAN WEIGHT 14,900 LBS.
MEAN C G 30.2 % \bar{c}

FIG. 13.(b) LOADS MEASURED IN LEVEL FLIGHT AT 20,000 FEET—AFT C G.

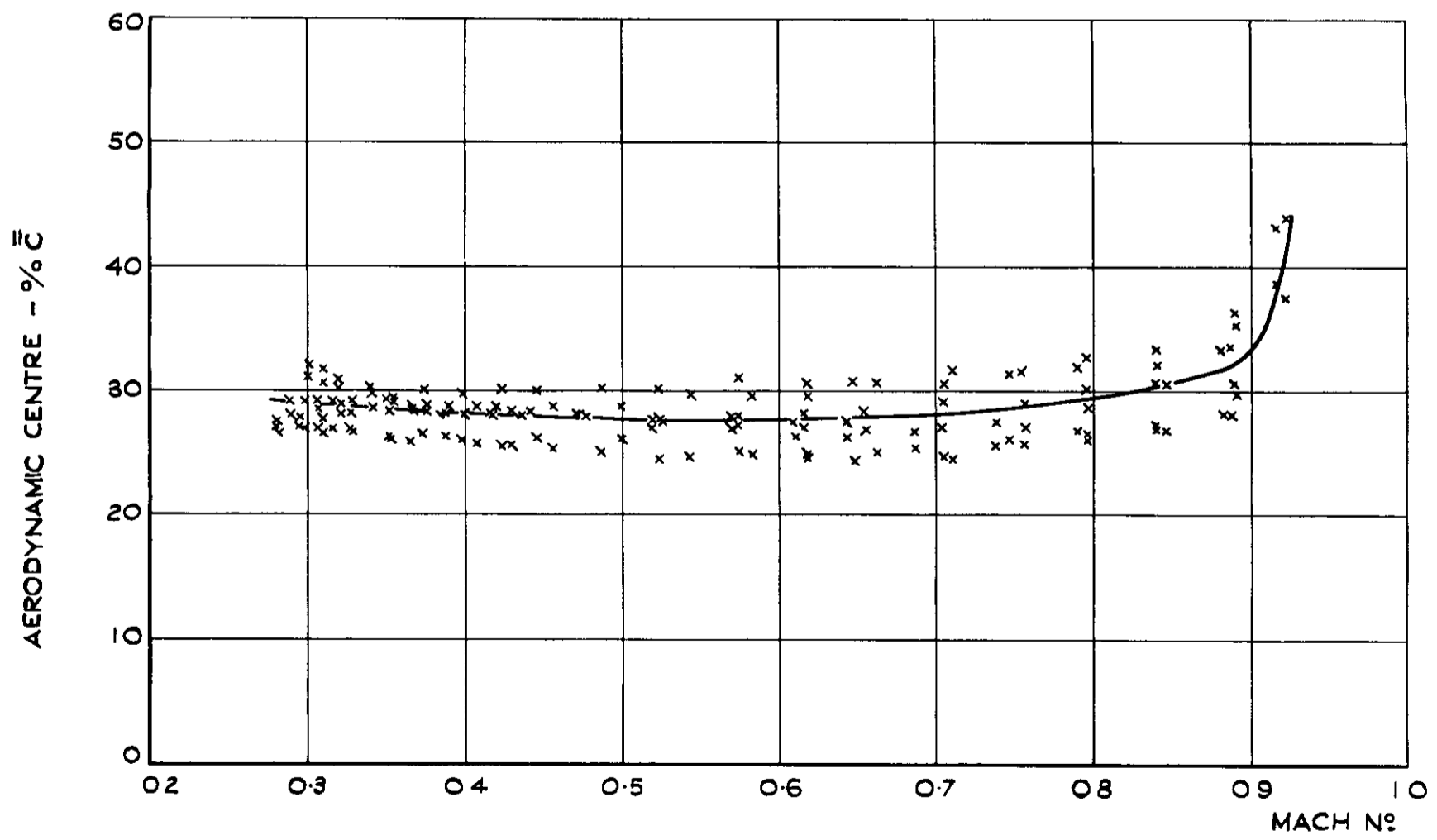

FIG. 14. AERODYNAMIC CENTRE OF WING PLUS FUSELAGE AHEAD OF SHEAR GAUGES.

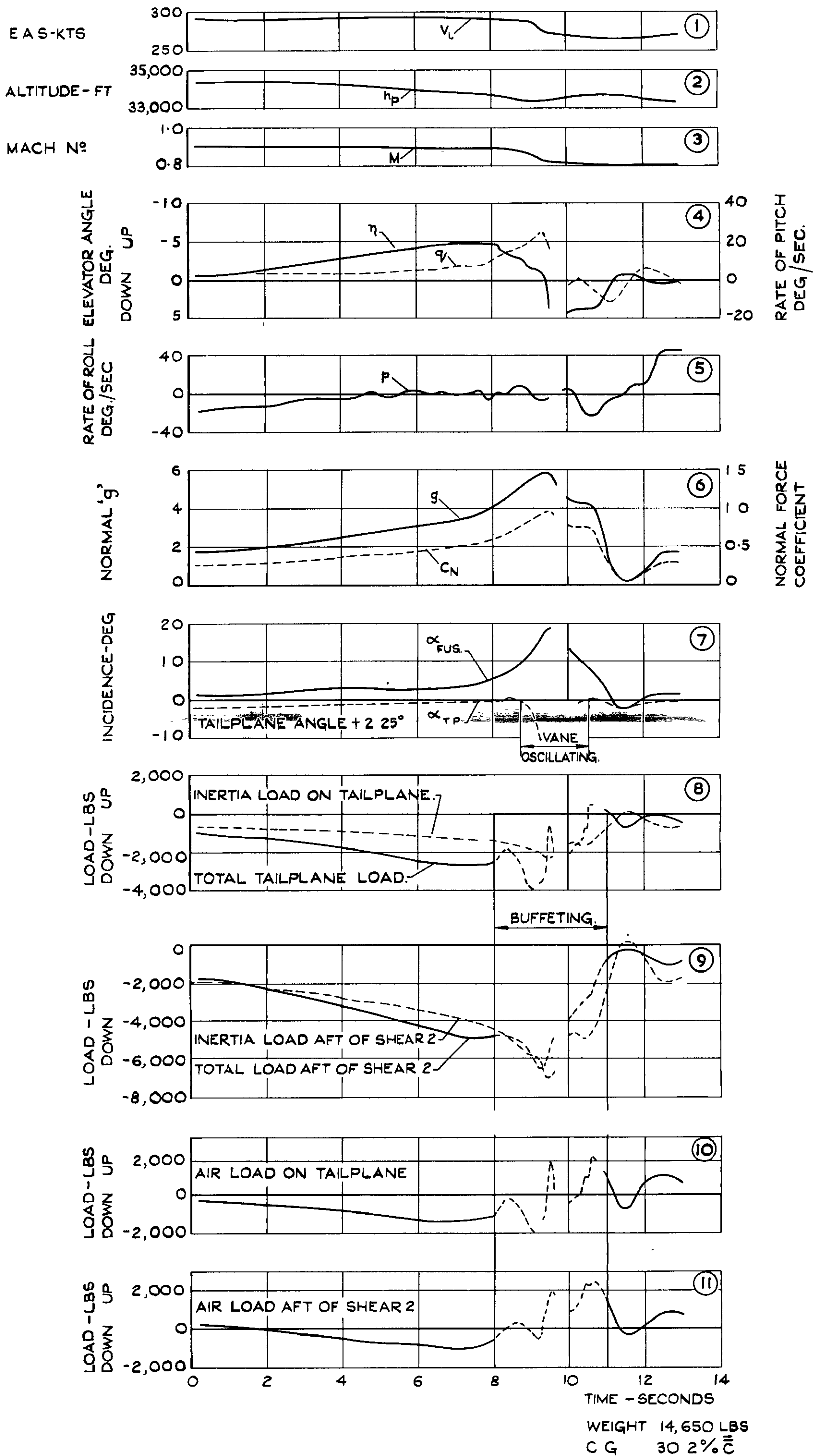

FIG.15(a) TIME HISTORY OF A PITCH-UP AT M=0.9, WITH IMMEDIATE RECOVERY.

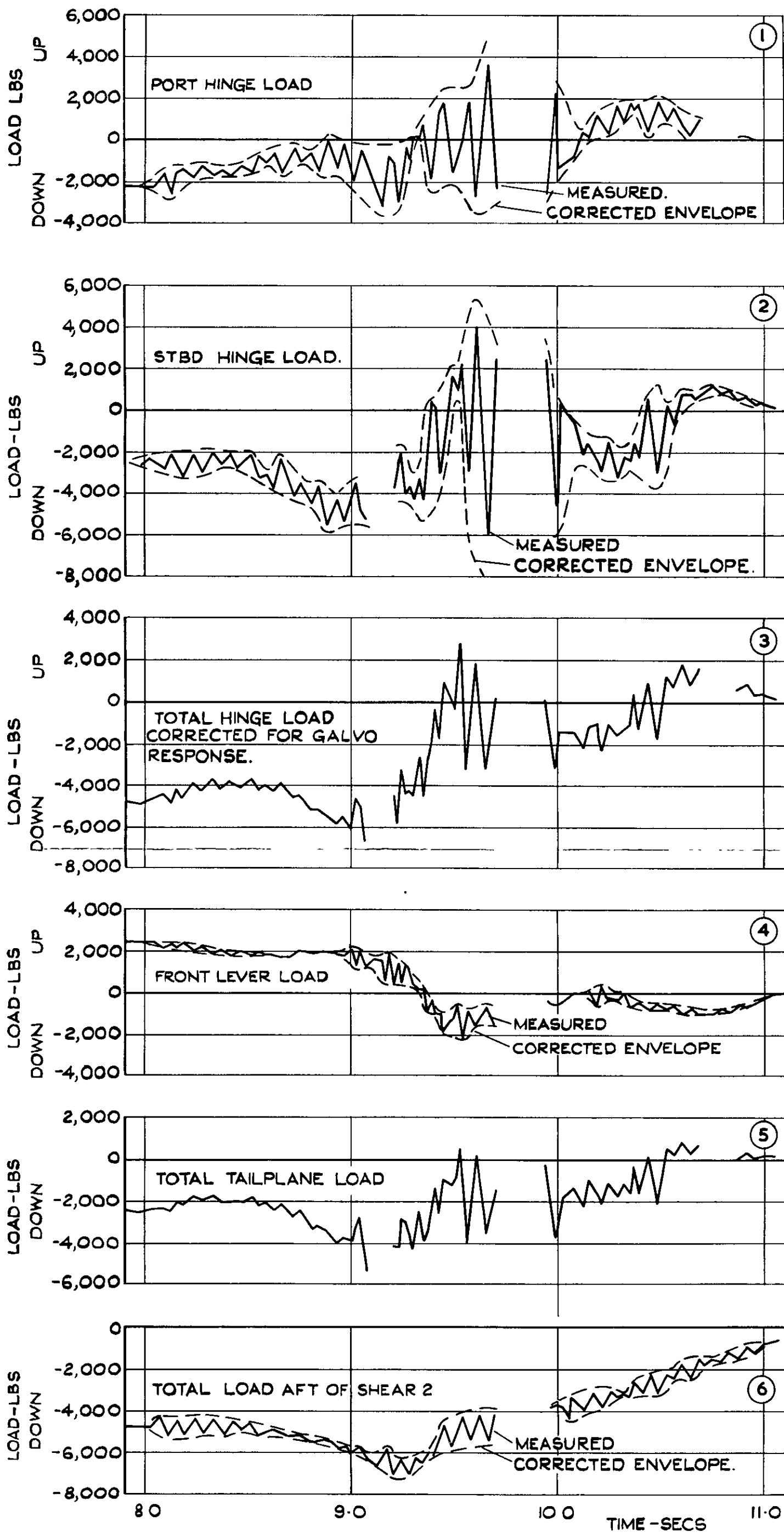

FIG. 15.(b) BUFFETING LOADS DURING THE PITCH-UP SHOWN IN FIG. 15(a)

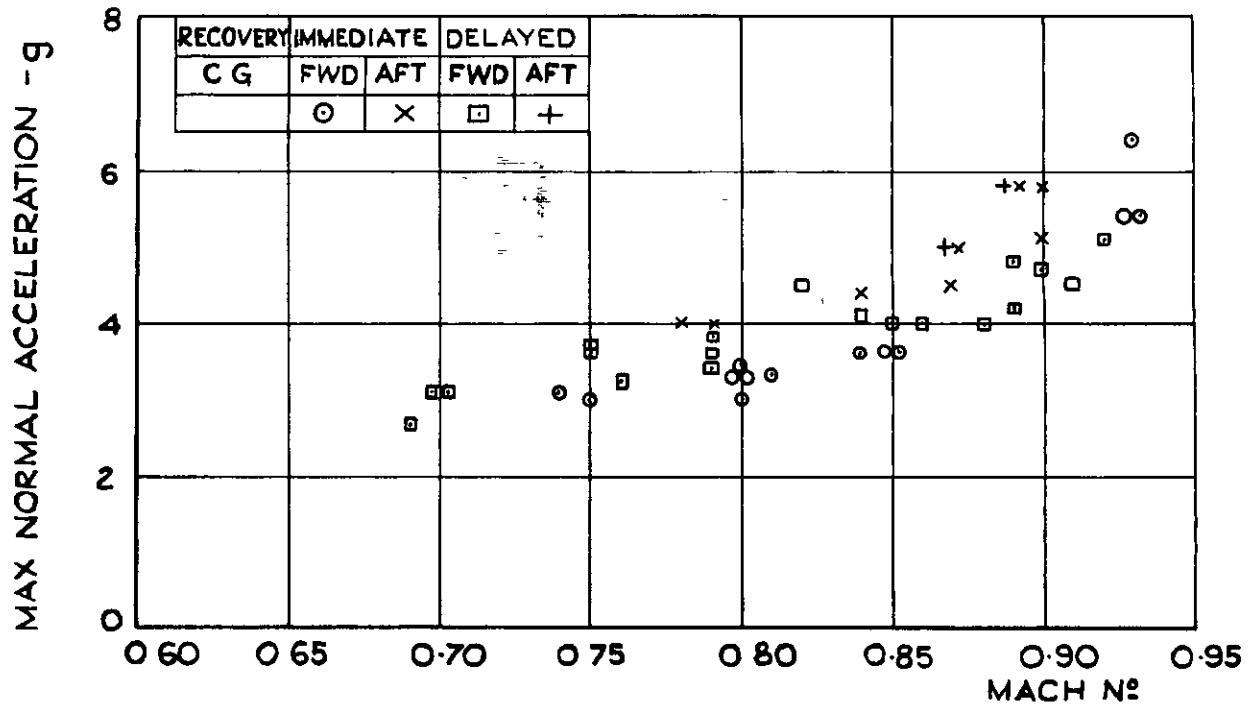

FIG.16. MAXIMUM NORMAL ACCELERATION IN PITCH-UPS.

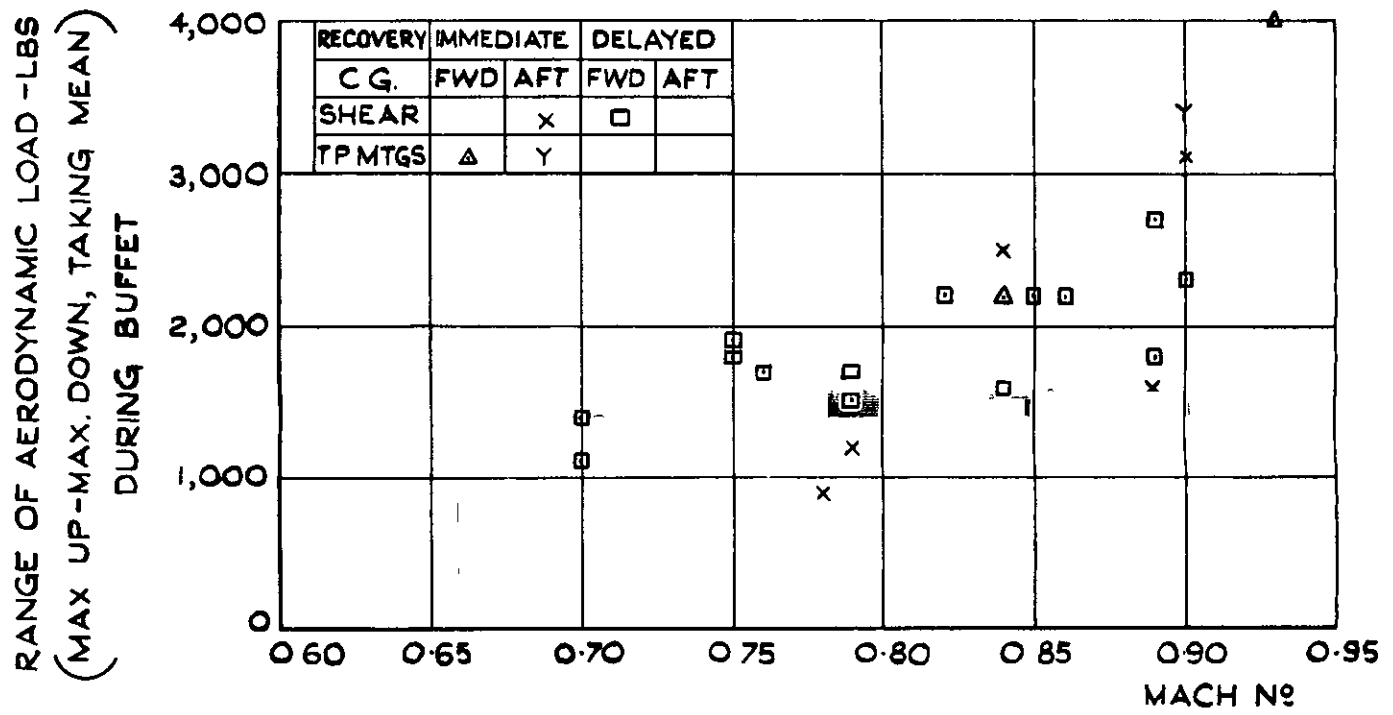

FIG.17. RANGE OF AERODYNAMIC LOAD IN PITCH-UPS, vs. MACH No.

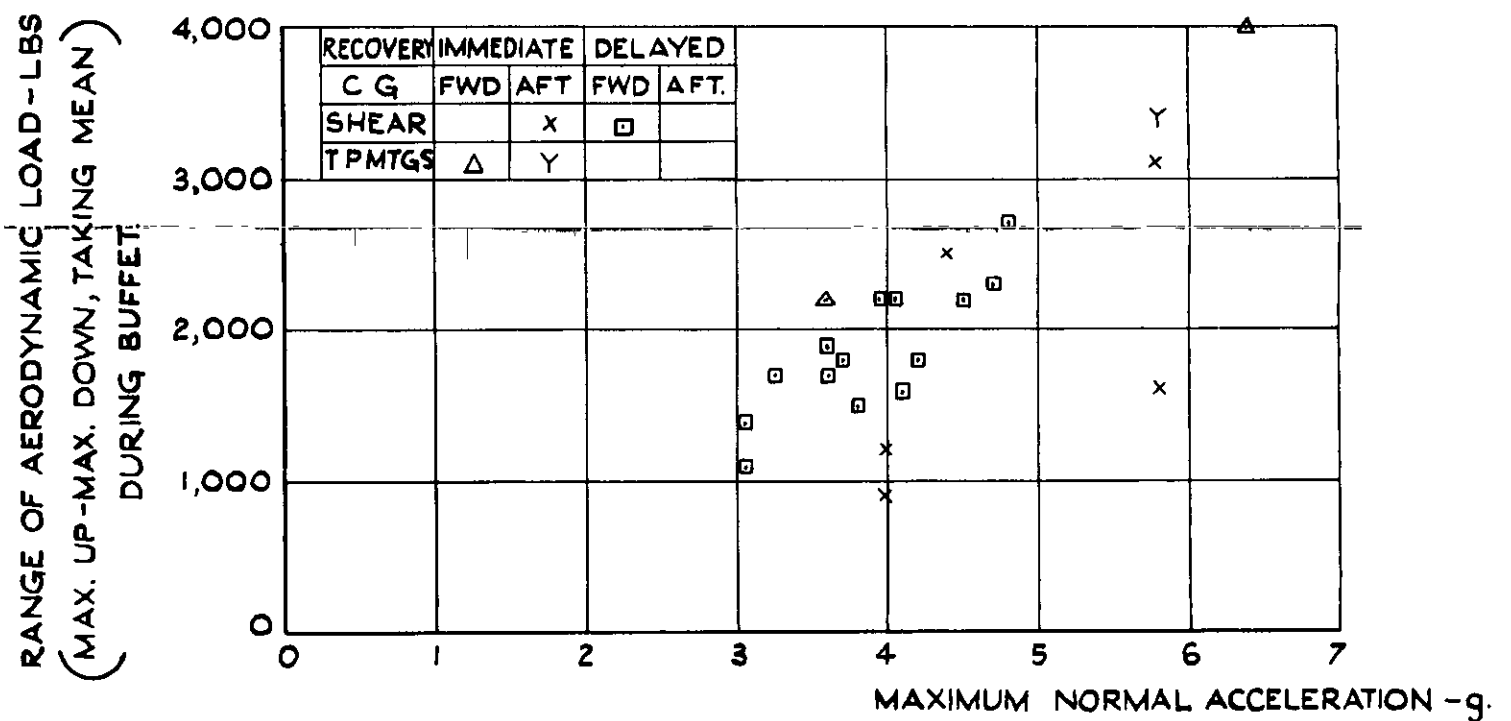

FIG.18. RANGE OF AERODYNAMIC LOAD IN PITCH-UPS, vs. MAX. NORMAL ACCELERATION

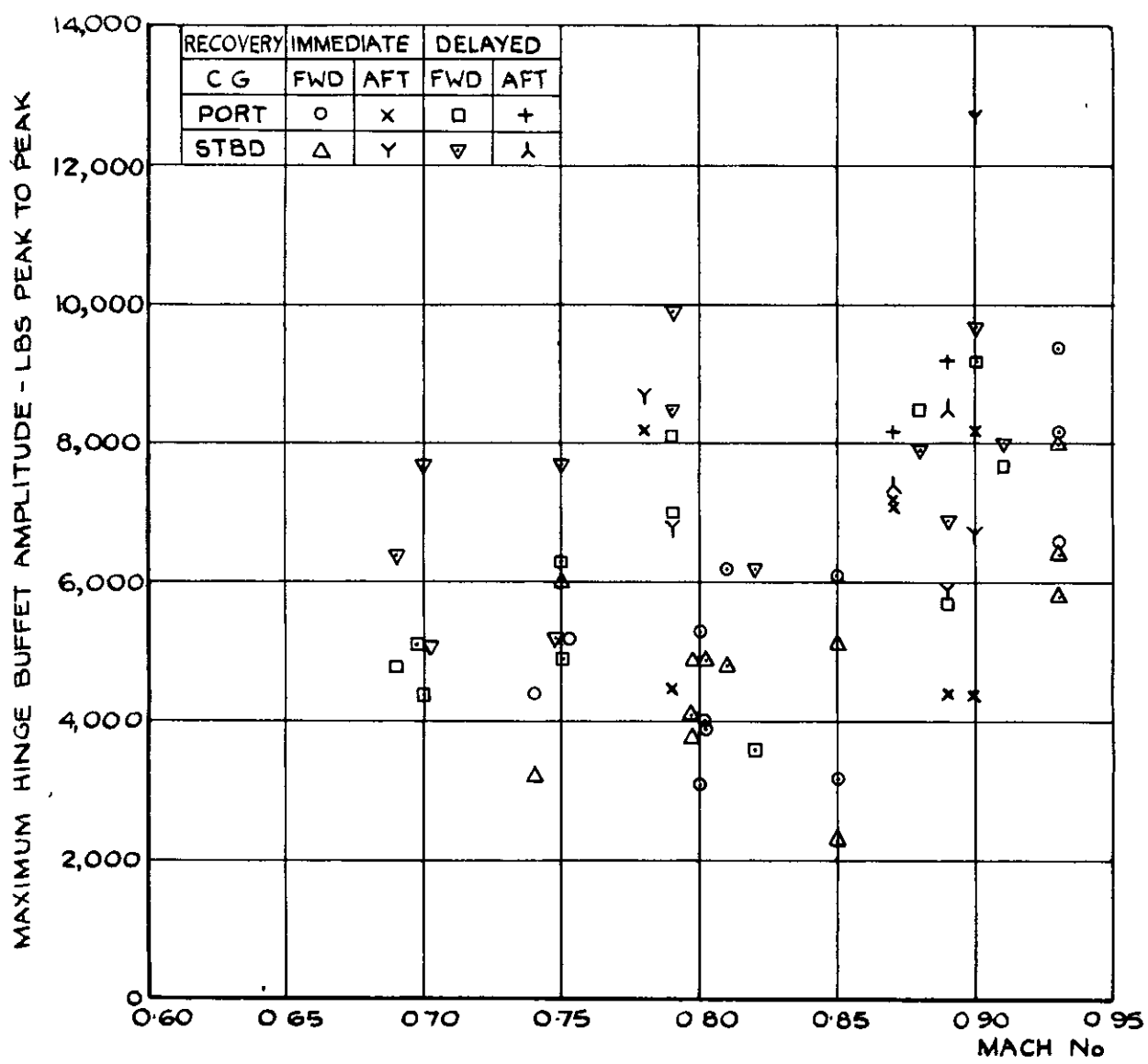

FIG. 19a. MAXIMUM HINGE BUFFET AMPLITUDE IN PITCH-UPS.

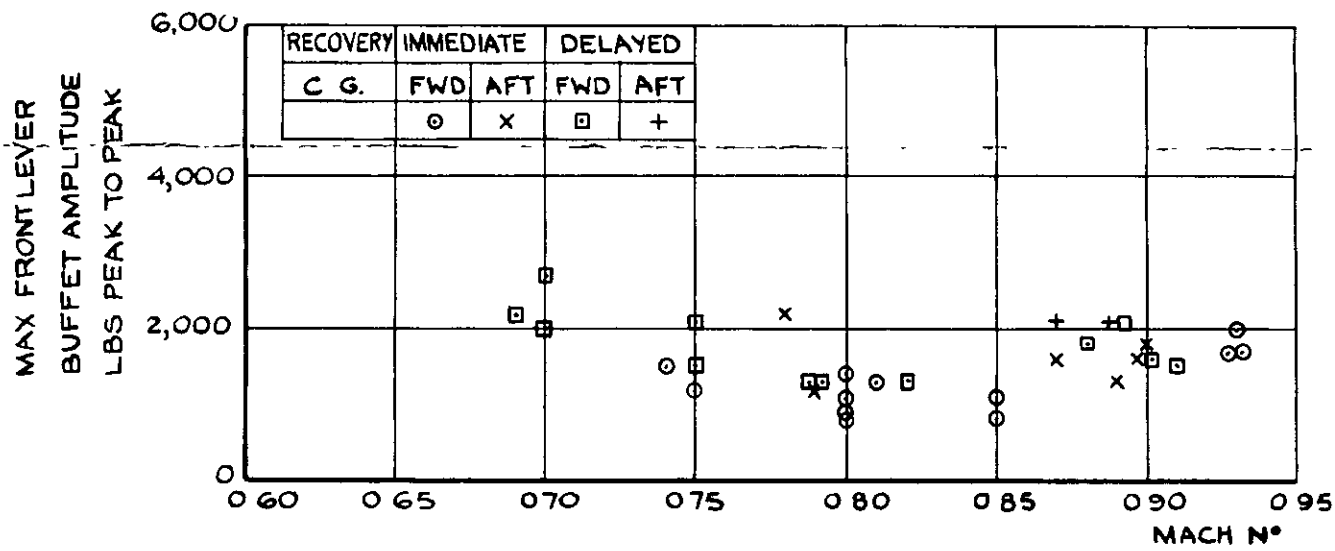

FIG. 19 b. MAXMUM FRONT LEVER BUFFET AMPLITUDE PITCH-UPS.

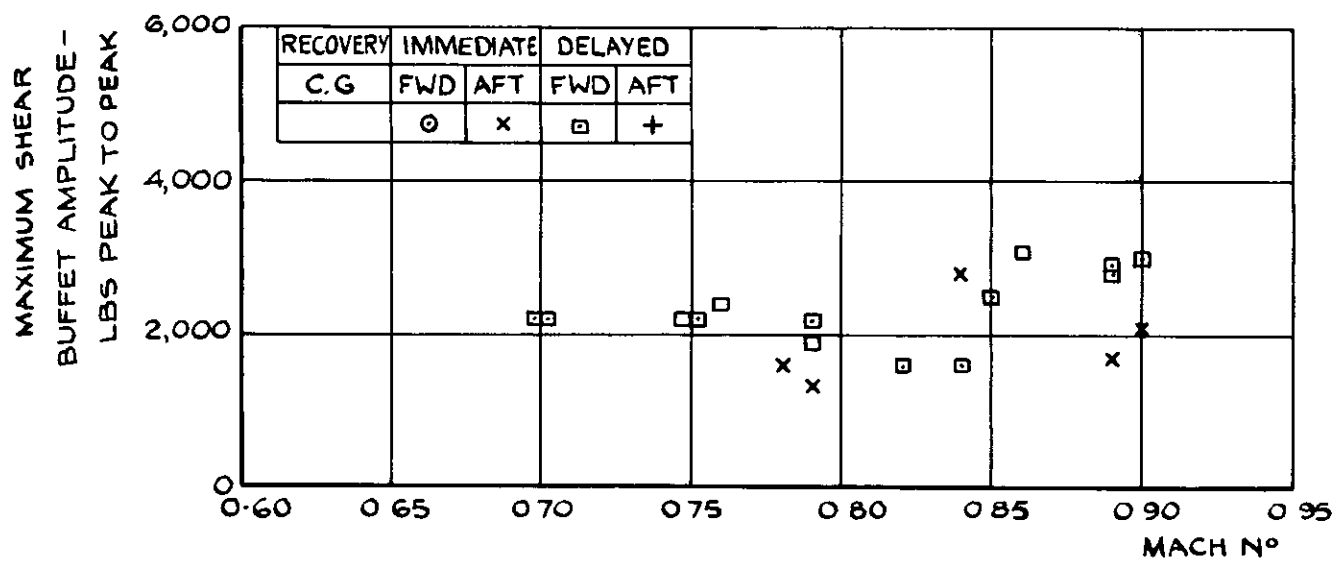

FIG. 19 c. MAXIMUM SHEAR BUFFET AMPLITUDE IN PITCH-UPS.

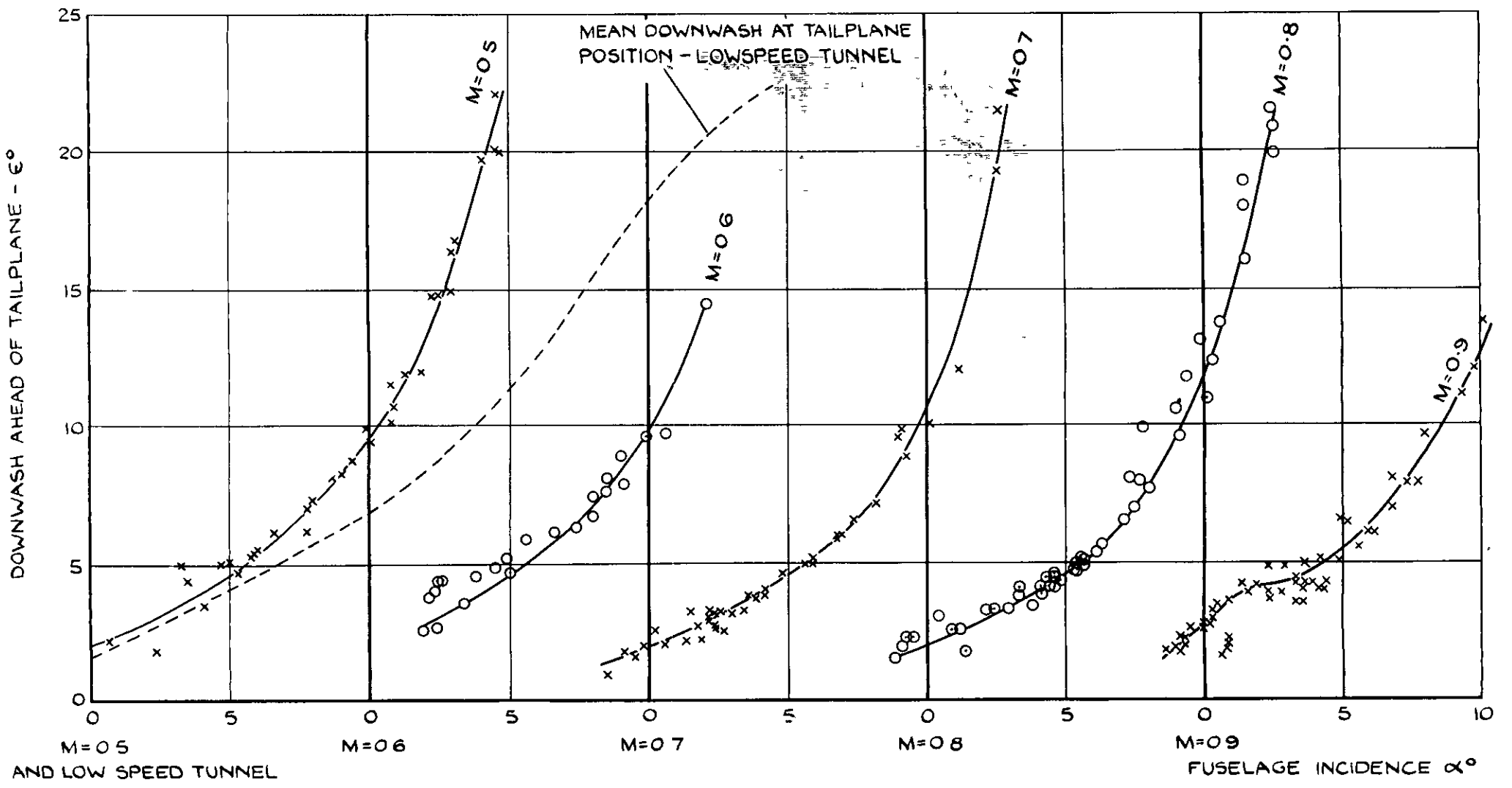

FIG 20. DOWNWASH AHEAD OF TAILPLANE AT MID-SEMISPAN.

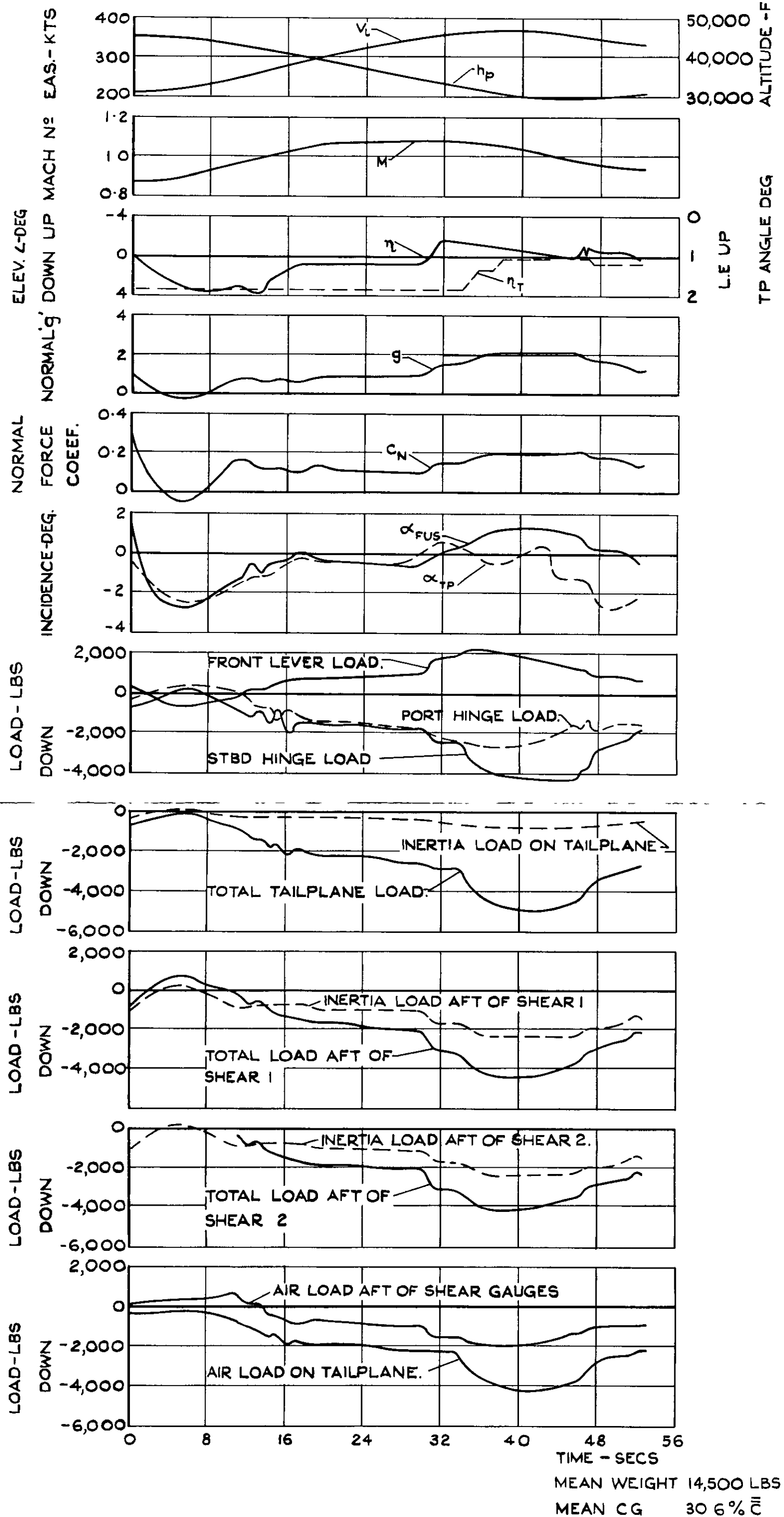

FIG. 21. TIME HISTORY OF A TRANSONIC DIVE.

A.R.C. C.P. No. 754

AI(42) Hawker Hunter:

533.652.1:

533.694.531:

533.6.048.5:

531.71.082.7

TESTS ON A HUNTER F.2 OF TWO STRAIN GAUGE METHODS FOR MEASURING TAILPLANE LOADS IN FLIGHT, WITH SOME LOADS MEASURED IN LEVEL FLIGHT, PITCH-UPS AND TRANSONIC DIVES. Nicholas, O.P. April 1963.

Two methods for measuring tailplane loads have been tested in flight on a Hunter F.2 aircraft. One method used modified tailplane mountings which provided a satisfactory means of checking, in flight, the datums of their strain gauge bridges. Although hysteresis and other non-linearities in the load calibrations, together with fairly rapid temperature drift, limited the measuring system's usefulness in the flight tests, it appears that, with refinements in design, it should offer a good method for measuring absolute tail loads. The second measuring system, using shear

(Over)

A.R.C. C.P. No. 754

AI(42) Hawker Hunter:

533.652.1:

533.694.531:

533.6.048.5:

531.71.082.7

TESTS ON A HUNTER F.2 OF TWO STRAIN GAUGE METHODS FOR MEASURING TAILPLANE LOADS IN FLIGHT, WITH SOME LOADS MEASURED IN LEVEL FLIGHT, PITCH-UPS AND TRANSONIC DIVES. Nicholas, O.P. April, 1963.

Two methods for measuring tailplane loads have been tested in flight on a Hunter F.2 aircraft. One method used modified tailplane mountings which provided a satisfactory means of checking, in flight, the datums of their strain gauge bridges. Although hysteresis and other non-linearities in the load calibrations, together with fairly rapid temperature drift, limited the measuring system's usefulness in the flight tests, it appears that, with refinements in design, it should offer a good method for measuring absolute tail loads. The second measuring system, using shear

(Over)

A.R.C. C.P. No. 754

AI(42) Hawker Hunter:

533.652.1:

533.694.531:

533.6.048.5:

531.71.082.7

TESTS ON A HUNTER F.2 OF TWO STRAIN GAUGE METHODS FOR MEASURING TAILPLANE LOADS IN FLIGHT, WITH SOME LOADS MEASURED IN LEVEL FLIGHT, PITCH-UPS AND TRANSONIC DIVES. Nicholas, O.P. April 1963.

Two methods for measuring tailplane loads have been tested in flight on a Hunter F.2 aircraft. One method used modified tailplane mountings which provided a satisfactory means of checking, in flight, the datums of their strain gauge bridges. Although hysteresis and other non-linearities in the load calibrations, together with fairly rapid temperature drift, limited the measuring system's usefulness in the flight tests, it appears that, with refinements in design, it should offer a good method for measuring absolute tail loads. The second measuring system, using shear

(Over)

strain gauges attached to the fuselage sides ahead of the tailplane, gave suitable load calibrations but was subject to considerable temperature drift. Reasonable agreement was obtained between the two systems, on incremental changes in aerodynamic load, over short time intervals (less than 30 seconds). In all cases the maximum loads measured were well below the structural strength limitations of the aircraft.

strain gauges attached to the fuselage sides ahead of the tailplane, gave suitable load calibrations but was subject to considerable temperature drift. Reasonable agreement was obtained between the two systems, on incremental changes in aerodynamic load, over short time intervals (less than 30 seconds). In all cases the maximum loads measured were well below the structural strength limitations of the aircraft.

strain gauges attached to the fuselage sides ahead of the tailplane, gave suitable load calibrations but was subject to considerable temperature drift. Reasonable agreement was obtained between the two systems, on incremental changes in aerodynamic load, over short time intervals (less than 30 seconds). In all cases the maximum loads measured were well below the structural strength limitations of the aircraft.

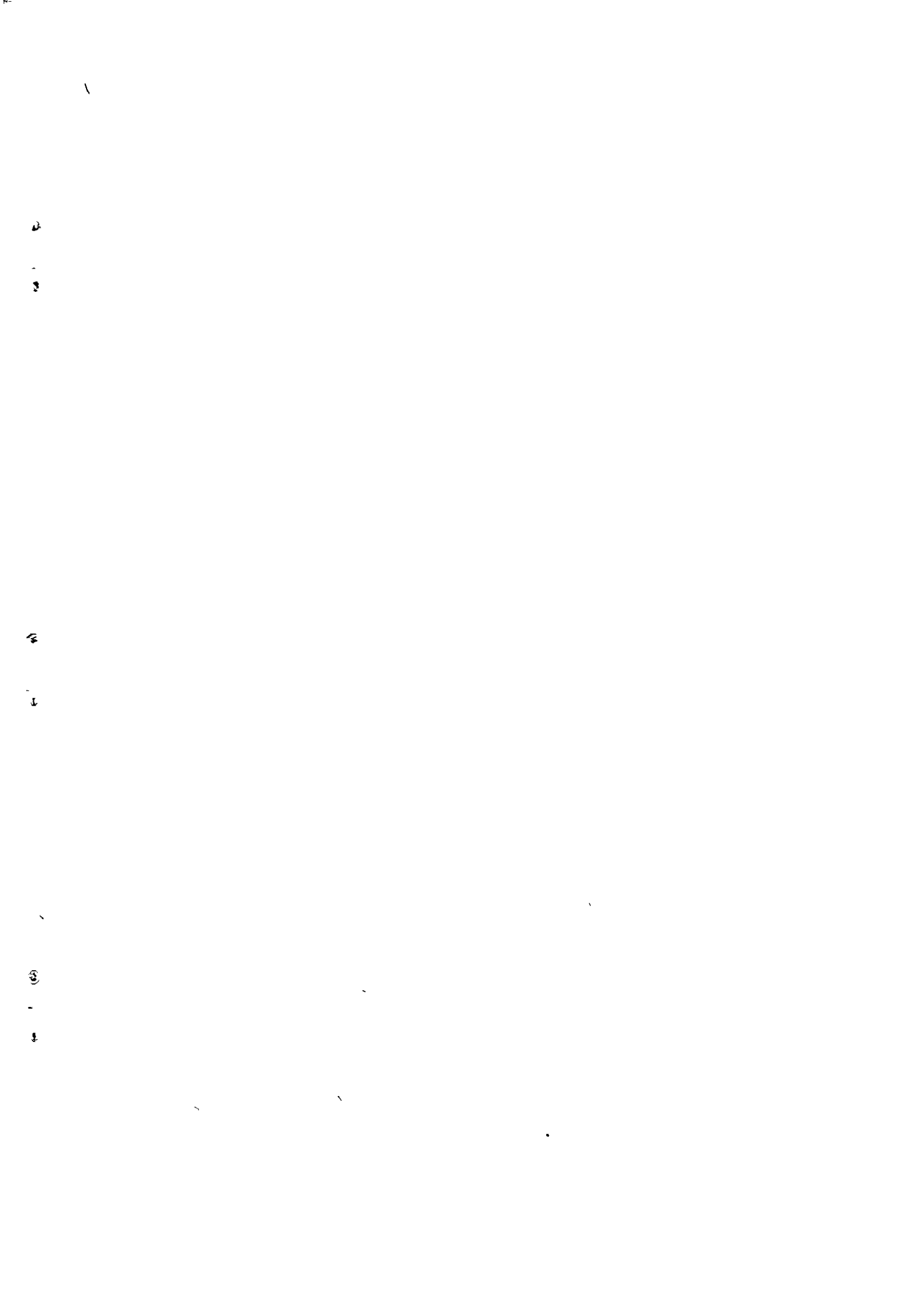

C.P. No. 754

© *Crown Copyright 1964*

Published by
HER MAJESTY'S STATIONERY OFFICE

To be purchased from
York House, Kingsway, London W.C.2
423 Oxford Street, London W 1
13A Castle Street, Edinburgh 2
109 St Mary Street, Cardiff
39 King Street, Manchester 2
50 Fairfax Street, Bristol 1
35 Smallbrook, Ringway, Birmingham 5
80 Chichester Street, Belfast 1
or through any bookseller

C.P. No. 754

S.O. CODE No 23-9015-54