

N.A.A.

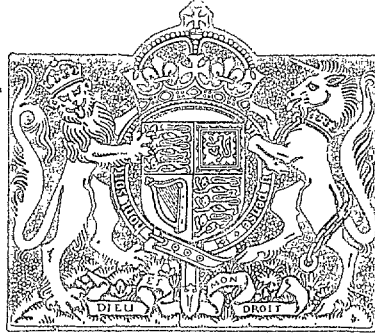

MINISTRY OF SUPPLY

AERONAUTICAL RESEARCH COUNCIL  
REPORTS AND MEMORANDA

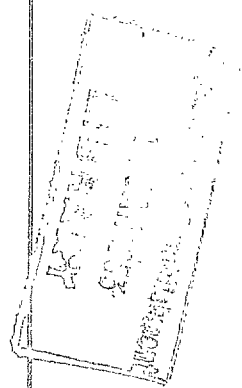

No. 2, 11½-ft Wind-Tunnel Tests of a Small  
Span, Small Chord Double Aileron for Use  
as a Lateral Control on a High-Lift Aircraft

By

A. D. YOUNG, M.A. and W. S. D. MARSHALL, D.Ac.(Hull)

*Crown Copyright Reserved*

LONDON: HER MAJESTY'S STATIONERY OFFICE

1952

PRICE 8s 6d NET

# No. 2, 11½-ft Wind-Tunnel Tests of a Small Span, Small Chord Double Aileron for Use as a Lateral Control on a High-Lift Aircraft

By

A. D. YOUNG, M.A. and W. S. D. MARSHALL, D.Ae.(Hull)

COMMUNICATED BY THE PRINCIPAL DIRECTOR OF SCIENTIFIC RESEARCH (AIR),  
MINISTRY OF SUPPLY

---

*Reports and Memoranda No. 2536\**

*February, 1946*

---

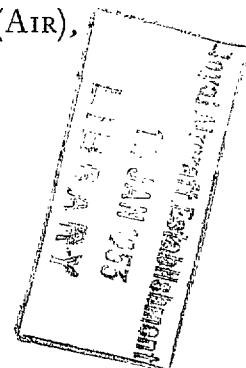

*Summary.*—Tests were made on a 1/2·25 scale model of a half wing of the Master. The span of the aileron was 0·22s and the chords were 0·2c̄ and 0·15c̄; the aileron was fitted with a balance tab of 0·05c̄ chord (*see* Table 1 and Fig. 1). Measurements were made of the hinge moments, lift increments (from which the rolling moments were deduced) and the pressures in the aileron gaps just above and below the seals. The latter were required for estimating the effect of internal shrouded nose (or pressure) balances. Tests were also made of the effect on the hinge and rolling moments of a small spoiler situated just aft of the front aileron vent; the spoiler was assumed to emerge on the lower surface of the down-going aileron and on the upper surface of the up-going aileron.

The main conclusions are (*see* section 6 for a more detailed summary) :—

- (1) A double aileron will give much the same rolling moment as a single aileron of the same total chord and at the same total deflection.
- (2) The double aileron offers no advantage where total deflections of magnitude not greater than about 20 deg are required (as for ailerons of normal span and area). For ailerons of small span and chord, for which deflections of the order of 50 deg are required, the double aileron offers definite advantages over the single aileron.
- (3) An inter-aileron gearing ( $d\xi_2/d\xi_1$ ) of about 2 is probably the optimum.
- (4) For a representative carrier-borne aircraft it is estimated that, even with this inter-aileron gearing, either the tab balance plus a nose balance of upwards of 40 per cent or a nose balance approaching 50 per cent is required to keep the stick forces for full control at landing speeds down to an acceptable figure.
- (5) The effect of the spoiler is only apparent for control movements of less than about 20 deg. Its possibilities on ailerons of normal span and angular range are worth investigating.

---

\* R.A.E. Report No. Aero. 2111, received 17th April, 1946.

## NOTATION

$V$	Speed of undisturbed air stream (ft/sec)
$V_i$	Indicated speed (ft/sec)
$\alpha$	Wing incidence
$\bar{c}$	Wing chord averaged over span of aileron
$s$	Semi-span of wing
$c_1$	Chord of front aileron
$c_2$	Chord of rear aileron
$l_1$	Length of shrouded nose balance of front aileron
$l_2$	Length of shrouded nose balance of rear aileron
$S_1$	Area of front aileron
$S_2$	Area of rear aileron
$\xi_1$	Front aileron deflection
$\xi_2$	Rear aileron deflection, relative to front aileron
$(\xi_1 + \xi_2)$	Total angular movement
$\xi_3$	Tab deflection
$\delta_s$	Stick angular movement
$K$	Gearing between total aileron movement and stick, <i>i.e.</i> , $(\xi_1 + \xi_2)/\delta_s$
$d\xi_2/d\xi_1$	Inter-aileron gearing
$C_l$	Rolling-moment coefficient
$H_1$	Hinge moment about front hinge
$H_2$	Hinge moment about rear hinge
$H_s$	Stick hinge moment
$P$	Stick force
$C_{h1}$	$H_1/S_1c_1 \frac{1}{2}\rho V^2$
$C_{h2}$	$H_2/S_2c_2 \frac{1}{2}\rho V^2$
$C_{hs}$	$H_s/KS_1c_1 \frac{1}{2}\rho V^2$
$p$	Static pressure
$p_0$	Static pressure of undisturbed stream
$\dot{p}_A, \dot{p}_B, \dot{p}_C, \dot{p}_D$	$\left(\frac{\dot{p} - \dot{p}_0}{\frac{1}{2}\rho V^2}\right)$ for the points A, B, C and D respectively ( <i>see</i> Fig. 1b)

Percentage balance is here defined as  $100l_1/(l_1 + c_1)$

1. *Introduction.*—It has been suggested that, in order to meet the growing need for smaller control hinge moments, the use of smaller chords and larger angular deflections than is conventional should be adopted. The idea underlying this suggestion is that, as far as the hinge-moments are concerned, the smaller arm of the flap load associated with a smaller chord will outweigh the increase in the load due to the greater deflection needed to provide the same control effectiveness. Recent American research has demonstrated that this idea is a promising one. For example, it was found by Sears and Purser<sup>1</sup>, (1943), that, except at large negative incidences, a  $0.2c$  chord plain flap deflected to  $60^\circ$  produced as much lift as a  $0.5c$  plain flap deflected to  $30^\circ$  for a hinge moment about one-third of that of the longer flap.

The idea can clearly be taken a stage further by adopting a double-flap type of control of relatively small chord in which the control is broken and hinged at some point along its chord, and the two parts are so geared that the rear part is deflected relative to the front. Apart from the smaller hinge moments to be expected with this arrangement, it has the aerodynamic advantage of cambering the wing contour more smoothly than does the equivalent single flap. Tests have been made in America of a plain double flap, for which the chords of the front and rear flaps were  $0.2c$  and  $0.15c$  respectively, and inter-aileron gear ratios (*i.e.*,  $d\xi_2/d\xi_1$ ) of  $1.0$  and  $2.0$  were tested.<sup>1</sup> The results showed this double flap to be quite as effective as the single flap of  $0.2c$  chord but requiring a hinge moment of the order of only half to three quarters of that of the single flap. The hinge moment for the control gear ratio of  $2.0$  was, on the whole, slightly smaller than that for the gear ratio of  $1.0$ .

To reduce the hinge moments still further the double control can obviously be combined with any of the usual forms of balance. Of these the internal pressure (or shrouded nose) balance of the Irving type (*e.g.*, see Fig. 7) and the balance tab most readily suggest themselves. The former type of balance is attractive because the angular range of the front control need not be larger than that of conventional controls, and hence it permits a larger nose beak, on which the balancing pressures can act, than would be possible with a single control of the same overall chord. This effect is to some extent reduced, however, by the fact that a smaller gearing is then required between the front control (and hence the beak) and the stick (*see* section 5.24). In addition, balancing pressures can be obtained on the inner walls of the front control, if a seal between the hinges of the two controls can be provided (*see* Fig. 7). In order to investigate the possibilities of a double flap as an elevator control, tests have been made in America on a  $0.3c$  double flap (rear flap chord =  $0.2c$ ), various control gear ratios and degrees of nose balances being tested (Liddell<sup>2</sup>, 1944). The results confirmed that this form of balance is promising for double controls. The optimum control gear ratio was then found to be about  $1.0$ , but the method of gearing adopted for these tests was essentially different from that of the earlier tests (*see* Appendix I).

For high-lift aircraft involving large span flaps, the span of the ailerons is necessarily severely limited. Therefore, to provide effective aileron control, either some form of spoiler control or ailerons of very wide chord have generally been considered. Both these forms of control have, however, important defects, and a really satisfactory form of control is still to be found. Insofar as the double flap of small chord with some balance promises effectiveness combined with small hinge moments, it has considerable possibilities as an aileron control for high-lift aircraft. This was pointed out by Gates and Thomas<sup>3</sup>, and on their recommendation wind-tunnel tests have now been made to examine these possibilities. These tests, which constitute the first three-dimensional tests of the double aileron to be made as yet, form the subject of this report. They were designed to include the effect of a balance tab and also the effect of an internal pressure type of balance. Tests were also made of the effect of a small spoiler situated just downstream of the front aileron vent. The spoiler was presumed to emerge from the lower surface of the down-going aileron and the upper surface of the up-going aileron. It was hoped that the spoiler would increase the positive internal balancing pressure and so increase the effectiveness of the nose balance (*see* Fig. 1b), in addition it was expected to increase the rolling moment. This idea was suggested by Mr. H. B. Irving.

The tests were made in the Royal Aircraft Establishment No. 2,  $11\frac{1}{2}$  ft Wind Tunnel in January and February 1945.

2. *Description of Model and Tests.*—The model tested was that of a half-wing of the Master. A general arrangement of the model as tested in the tunnel is shown in Fig. 1. It will be seen that the main portion of the half-wing was suspended from the tunnel balances whilst the inner or stub portion was attached to the tunnel wall and braced to the roof. For all the tests the stub wing was rotated to agree in incidence with that of the main part of the wing and was then locked in position. The dimensions of the wing and double aileron are detailed in Table 1. It will be seen that the span of the aileron was only about 22 per cent of the half-wing span (measured from tip to wall, including stub portion), its area was 3·85 per cent of the half-wing area, and the aileron chords were about  $0\cdot2\bar{c}$  and  $0\cdot15\bar{c}$ , where  $\bar{c}$  is the wing chord averaged over the span of the aileron. A representative cross-section of the aileron is shown in Fig. 1b, which also illustrates the balance tab of chord  $0\cdot05\bar{c}$  and span equal to that of the aileron. Each hinge gap was sealed with a strip of thin rubber, a V-shaped wedge being cut in the semi-circular nose back to the hinge to allow a free movement of each control of about  $\pm 30$  deg. The front hinge pivoted in bearings fixed to the wing structure, the rear hinge pivoted in bearings fixed in the front aileron. Above and below each seal there were pressure holes at the points marked A, B, C and D in Fig. 1b. The static pressures recorded at these holes were required in estimating the effect of internal beak or pressure balances. The holes were connected to a multi-tube manometer, and the pressures were recorded photographically. The balance tab setting was fixed for each test by means of bent plates fitting into grooves in the tab and rear aileron; a set of these plates was made to cover a range of tab angles from  $+20$  to  $-20$  deg.

For the tests with spoilers, the latter were simulated by right-angled brass plates screwed to the surface of the front control just aft of the hinge vent. The spoilers ran the full span of the ailerons, and two spoiler heights were tested, namely  $\frac{1}{2}$  in. and 1 in. (*i.e.*, about 1·8 and 3·6 per cent of  $\bar{c}$ ).

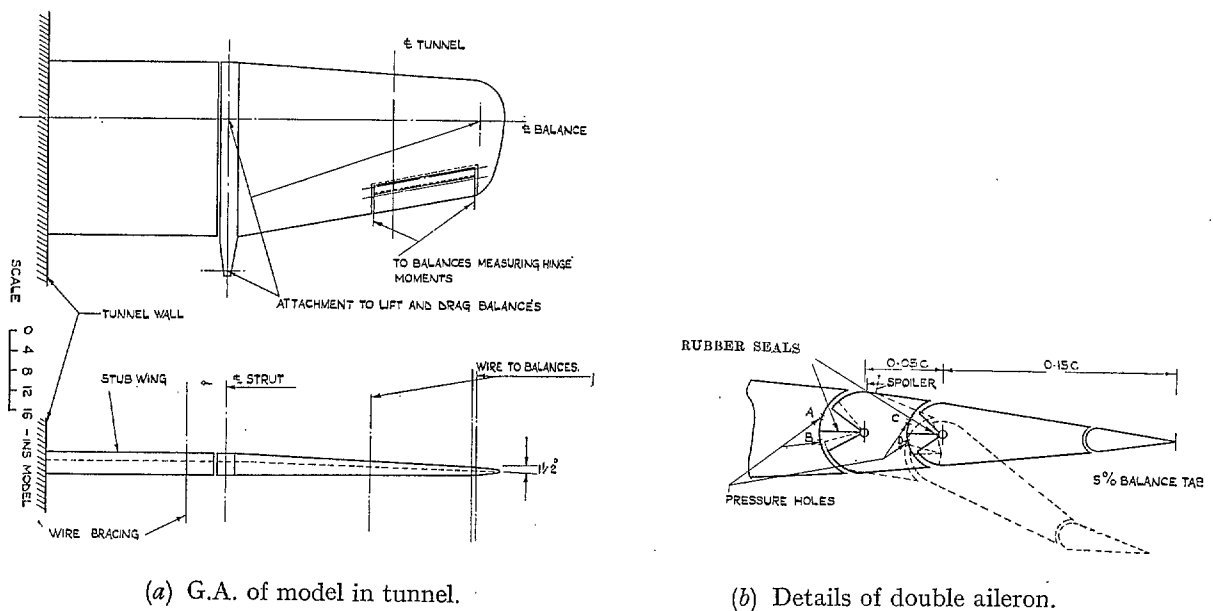

FIG. 1.

TABLE 1

*Details and Dimensions of the Model*

<i>Wing</i>	
Total span of half-wing model ( <i>i.e.</i> including stub) ..	93·6 in.
Span of stub wing .. .. .	34·7 in.
Root chord .. .. .	36·0 in.
Tip chord .. .. .	26·0 in.
Half-wing area (including stub) .. .. .	20·96 sq ft
Dihedral angle .. .. .	1·5 deg
<i>Aileron</i>	
Wing section at aileron mid-span .. .. .	NACA 23012
Span of aileron .. .. .	20·8 in.
Chord of first aileron .. .. .	5·60 in.
Chord of second aileron .. .. .	4·20 in.
Area of first aileron .. .. .	0·807 sq ft
Area of second aileron .. .. .	0·605 sq ft
Percentage aileron span .. .. .	22·2 per cent
Percentage aileron area .. .. .	3·85 per cent

A small sting was fitted to each part of the double aileron and each sting was connected by a roughly vertical wire to an arm of an auxiliary balance supported on the main lift balance. In this way the hinge moments about the two hinges of the control were measured separately.

The measurements made, therefore, included the lift on the main part of the wing, the internal hinge gap pressures and the two control hinge moments. These measurements were made for the following values of the parameters wing incidence ( $\alpha$ ), front aileron angle ( $\xi_1$ ), rear aileron angle relative to front aileron ( $\xi_2$ ) and tab angle ( $\xi_3$ ):—

TABLE 2

$\alpha = 0, 6, 12$  deg.  $\xi_3 = 0, \mp 5, \mp 10, \mp 15, \mp 20$  deg

$\xi_1$ deg	$\xi_2$ deg	$\xi_1$ deg	$\xi_2$ deg
0	0	$\pm 25$	0
$\pm 5$	0	$\pm 25$	$\pm 25$
$\pm 5$	$\pm 5$	0	$\pm 5$
$\pm 5$	$\pm 10$	0	$\pm 10$
$\pm 10$	$\pm 0$	0	$\pm 15$
$\pm 10$	$\pm 10$	0	$\pm 20$
$\pm 10$	$\pm 20$	0	$\pm 30$
$\pm 15$	0	$\mp 5$	$\mp 5$
$\pm 15$	$\pm 15$	$\mp 10$	$\mp 10$
$\pm 15$	$\pm 30$	$\mp 20$	$\mp 20$
		$\mp 25$	$\mp 25$

The upper signs of the angles listed above formed one set of tests and the lower signs formed another.

It should be noted that the values chosen for the parameters  $\xi_1$  and  $\xi_2$  were such as to cover, as economically as possible, values of the inter-aileron gearing  $d\xi_2/d\xi_1$  of 0, 1·0, 2·0 and  $\infty$ . In this way it was hoped that the effect of gearing would be clearly demonstrated and an estimate of the optimum gearing would be obtained.

The additional tests with the spoilers were made for the following values of  $\alpha$ ,  $\xi_1$  and  $\xi_2$ , the tab setting  $\xi_3$  being kept zero:—

TABLE 3  
 $\alpha = 0, 12 \text{ deg}$

$\xi_1 \text{ deg}$	—5	— 5	—10	—10	—15	—15	—25
$\xi_2 \text{ deg}$	—5	—10	—10	—20	—15	—30	—25

The spoilers were tested only on the upper surface of the control.

After the usual tunnel corrections were applied the lift measurements were reduced to rolling moments due to the ailerons about the chord line of the inboard section of the stub wing in the plane of the tunnel wall. This was done by applying the theoretical results given in Ref. 4 for the centre of pressure of the change in lift due to an aileron control. A further correction was applied to allow for the fact that on a real aeroplane the change in loading is skew symmetric whereas for the arrangement tested the half-wing plus its image corresponds to a full wing with the ailerons operating in the same sense. This correction was also based on the calculations described in R. & M. 1259<sup>4</sup>. The final result obtained, therefore, was the rolling moment due to the aileron on a wing of span equal to twice the distance from the wing tip to the tunnel wall, in the presence of a second aileron operating in the opposite (and therefore usual) sense on the other half-wing.

The control hinge moments were corrected for the drag and inclination of the supporting wires leading to the auxiliary balances and also for the drag of the stings. These corrections were based on measurements of the wire inclinations and on measurements made with dummy stings. The method of determining stick hinge moments from the control hinge moments measured is described in detail in section 3.

For all the tests transition wires were fitted to both surfaces of the wing at 0.1c back from the leading edge; this was to avoid the possibility of extraneous effects due to transition point movements.

The tests were made at a wind tunnel speed of 150 ft/sec corresponding to a Reynolds number in terms of the mean wing chord of about  $2 \times 10^6$ .

3. *Conversion of Control Hinge Moment Measurements to Stick Hinge Moments.*—If  $H_1$  is the hinge moment about the first aileron hinge and  $H_2$  that about the second,  $d\xi_1$  an element of angular movement of the front aileron and  $d\xi_2$  an element of angular movement of the second aileron relative to the first, then by the equation of virtual work

$$H_1 d\xi_1 + H_2 d\xi_2 = H_s d\delta_s,$$

where  $H_s$  is the corresponding moment applied by the pilot about the stick pivot and  $d\delta_s$  the corresponding element of angular movement of the stick.

Hence

$$\begin{aligned} H_s &= H_1 \frac{d\xi_1}{d\delta_s} + H_2 \frac{d\xi_2}{d\delta_s}, \\ &= \frac{d\xi_1}{d\delta_s} \left[ H_1 + H_2 \frac{d\xi_2}{d\xi_1} \right]. \quad \dots \quad \dots \quad \dots \quad \dots \quad (1) \end{aligned}$$

It was found in the American test described in Refs. 1 and 2 and also in this series of tests (see section 5.1) that the lift increment (and hence the rolling moment) was a function of the total angular movement of the control, viz.  $(\xi_1 + \xi_2)$ , and was sensibly independent of the inter-aileron

gear ratio  $d\xi/d\xi_1$  for a wide range of values of this ratio. In order to compare the stick forces to be expected for a given rolling moment for the various inter-aileron gear ratios tested, it was felt, therefore, that a fair basis of comparison would be obtained on the assumption that

$$K\delta_s = (\xi_1 + \xi_2), \quad \dots \quad \dots \quad \dots \quad \dots \quad \dots \quad \dots \quad \dots \quad (2)$$

where  $K$  is a constant independent of the control gear ratio.

From (2) we have

$$\frac{d\xi_1}{d\delta_s} = K \left/ \left[ 1 + \frac{d\xi_1}{d\xi_2} \right] \right.$$

Hence, from (1)

$$H_s = K \left[ H_1 + H_2 \frac{d\xi_2}{d\xi_1} \right] \left/ \left[ 1 + \frac{d\xi_1}{d\xi_2} \right] \right. \dots \quad \dots \quad \dots \quad \dots \quad (3)$$

Let

$$C_{hs} = \frac{H_s}{K S_1 c_1 \frac{1}{2} \rho V^2}, \quad C_{h1} = \frac{H_1}{S_1 c_1 \frac{1}{2} \rho V^2}, \quad C_{h2} = \frac{H_2}{S_2 c_2 \frac{1}{2} \rho V^2},$$

where

$S_1$  is the area of the complete double aileron,

$c_1$  is the mean chord of the front aileron,

$S_2$  is the area of the rear aileron,

$c_2$  is the mean chord of the rear aileron.

Then

$$C_{hs} = \left\{ C_{h1} + C_{h2} \frac{S_2 c_2}{S_1 c_1} \cdot \frac{d\xi_2}{d\xi_1} \right\} \left/ \left( 1 + \frac{d\xi_2}{d\xi_1} \right) \right.$$

For the arrangement tested

$$\frac{S_2 c_2}{S_1 c_1} = 0.562,$$

and hence

$$C_{hs} = \left\{ C_{h1} + 0.562 C_{h2} \frac{d\xi_2}{d\xi_1} \right\} \left/ \left( 1 + \frac{d\xi_2}{d\xi_1} \right) \right. \dots \quad \dots \quad \dots \quad (4)$$

From the measured values of  $C_{h1}$  and  $C_{h2}$  the corresponding values of the stick hinge-moment coefficient  $C_{hs}$  were calculated by means of equation (4) for each value of the inter-aileron gear ratio considered. By plotting  $C_{hs}$  against the corresponding value of  $C_l$  (rolling-moment coefficient deduced from the lift measurements) the various inter-aileron gear ratios could then be directly compared.\*

4. *Results.*—All the results have been compiled in tabular form, and are available to those interested. Some representative results have been selected for presentation in graphical form.

In Fig. 2 the rolling-moment coefficient is plotted against the total angular movement ( $\xi_1 + \xi_2$ ) for the various inter-aileron gear ratios considered and with the tab setting ( $\xi_3$ ) zero. Fig. 3 shows the corresponding curves with  $\xi_3 = +20$  deg, whilst Fig. 4 shows the curves obtained with the spoilers. Figs. 5 and 6 show the lift coefficient  $C_L$  plotted against total flap deflection obtained in the American two-dimensional tests on a 0.2c double flap and a 0.3c double flap

\* In the above discussion no reference has been made to the response effect, which should strictly be included. For the ailerons tested, however, the results showed that the response effect was negligible.



described in Refs. 1 and 2. In Figs. 8, 9, 10 and 11 curves are plotted of  $C_l$  against  $C_{hs}$  for the various tab settings and incidences tested, and refer to values of  $d\xi_2/d\xi_1$  of 0, 1.0, 2.0 and  $\infty$ , respectively. Fig. 12 shows the corresponding curves obtained with spoilers. Figs. 13 to 18 give representative results obtained for the pressure coefficients measured at the four holes labelled A, B, C and D (see Fig. 1b), for various values of  $\xi_3$  and  $\alpha$ , in the absence of spoilers. Figs. 19 and 20 similarly illustrate some of the pressure coefficients measured with the spoilers.

5. Discussion.—5.1. *Rolling Moments.*—5.11. *Without spoilers.*—It is clearly brought out by the curves of Figs. 2 and 3 and also by the American results illustrated in Figs. 5 and 6 that, for a wide range of inter-aileron gear ratios, viz. for  $d\xi_2/d\xi_1$  varying from 0 to at least 2.0, there is no consistent change with gear ratio of the control effectiveness for a given total angular movement. This may be explained as resulting from the balance of two opposing effects. With increase of the gearing, more of the burden is imposed on the rear aileron, and hence on an aileron of smaller chord, and so we might expect the effectiveness for a given angular movement to fall; on the other hand, for a wide range of gearing, increase of the gearing improves the gentleness of the camber of the section and hence the effectiveness is increased. For the extreme case of  $d\xi_2/d\xi_1 = \infty$ , when the rear aileron alone is moved, there is a not unexpected reduction of effectiveness at the larger angular movements.

5.12. *With spoilers.*—Comparing Figs. 2 and 4 it will be seen that the spoilers add appreciably to the rolling moments developed for total angles ( $\xi_1 + \xi_2$ ) of magnitude up to about 20 deg at  $\alpha = 0$  deg, and up to about 10 deg at  $\alpha = 12$  deg. For larger angular movements, however, the effect of the spoilers is negligible. Presumably, a spoiler acts as a small auxiliary flap, the suction behind it helping to boost the circulation, but at large control angles the pressure built up ahead of the control nullifies the suction behind the spoiler. On the whole, with a spoiler present, the rolling moment developed for a given total angular movement is slightly greater for  $d\xi_2/d\xi_1 = 1.0$  than for  $d\xi_2/d\xi_1 = 2.0$ , but the difference is very small.

5.2. *Stick Hinge Moments and Forces.*—5.21. *Plain ailerons with and without balance tabs.*—A few points of interest may be noted from a study of the curves of Figs. 8 to 11 showing  $C_l$  plotted against  $C_{hs}$  for the four gearings  $d\xi_2/d\xi_1 = 0, 1, 2$  and  $\infty$ .

For values of  $C_l$  less than about 0.01 (from one aileron) there appears to be no advantage in using the double aileron, since the inter-aileron gearing  $d\xi_2/d\xi_1 = 0$  requires the least stick hinge moment. Further, for these small values of  $C_l$  the tab balance is most effective with this gearing, and its effectiveness decreases with increase of the gearing ratio. As the gearing ratio goes from 0 to  $\infty$  the aileron changes from the single 0.2c chord aileron to the single 0.15c chord aileron. Hence, the reduction in effectiveness of the balance tab with decrease of aileron chord is probably due to the relative increase in the importance of the adverse rolling moment produced by the tab.

At the higher values of  $C_l$ , however, both the single ailerons ( $d\xi_2/d\xi_1 = 0$  and  $\infty$ ) show a much more marked increase in the rate of increase of  $C_{hs}$  with  $C_l$  than the double aileron ( $d\xi_2/d\xi_1 = 1$  and  $2$ ). Owing to the experimental limitations it was impossible to test the single ailerons up to angles large enough to produce values of  $C_l$  of the order of 0.025 per aileron. It is probable that such a value of  $C_l$  would have been obtainable with the 0.2c single aileron ( $d\xi_2/d\xi_1 = 0$ ), but it is unlikely that the 0.15c aileron could have produced it. In any case, it is clear from the trends of the curves that it would only have been obtained with the single ailerons for values of  $C_{hs}$  considerably greater than those required with the inter-aileron gearings 1.0 and 2.0. For these latter gearings the curves are smooth and much more nearly linear over the whole range of angles tested.

In each case, at the higher values of  $C_l$ , there is some reduction in effectiveness of the balance tab, although this is less marked with the gearing 2.0 than with the gearing 1.0. This reduction in effectiveness of the tab at high values of  $C_l$  is due presumably to the fact that at the large aileron angles required, the tab is in a region of flow breakaway over the aileron; an additional factor is the reduction of the rolling moment caused by the tab.

It is generally accepted that for adequate rolling power at low speeds a  $C_l$  of about 0.05 (from both ailerons) is required, and for the high-lift aircraft we are considering it is reasonable to take this as the standard for which to aim.\* At this value of  $C_l$  (*i.e.*, 0.025 from each aileron) it appears that of the gearings tested the gearing 2.0 requires the smallest stick hinge moment.

To present the points already made in a more concrete form and to bring out clearly the order of the stick forces involved, the results have been applied to an aircraft with the following dimensions:—

Wing span	.. .. .	50 ft
Maximum stick movement	.. .. .	$\pm 30$ deg
Maximum total aileron movement ( $\xi_1 + \xi_2$ )	.. .. .	$\pm 50$ deg
Gearing factor between control movement and stick ( $K$ )	.. .. .	5/3
Length of stick from handle to pivot	.. .. .	2 ft 6 in.

The relation between stick moment ( $H_s$ ) and stick moment coefficient ( $C_{hs}$ ) is given by

$$H_s = KC_{hs} \frac{1}{2} \rho V^2 S_1 c_1 .$$

For the model tested  $S_2 = 0.807$  sq ft,  $c_1 = 0.467$  ft, and the wing span = 15.6 ft. Hence, the full-scale stick moment is given by

$$\begin{aligned} H_s &= 0.807 \times 0.467 \times \left( \frac{50}{15.6} \right)^3 \times \frac{5}{3} \times C_{hs} \times \frac{1}{2} \rho V^2 , \\ &= 245 C_{hs} \left( \frac{V_i}{100} \right)^2 \text{ lb ft} , \end{aligned} \quad \dots \dots \dots (5)$$

where  $V_i$  is the indicated speed in ft/sec.

With a stick arm of 2 ft 6 in. the stick force becomes

$$P_s = 98.1 C_{hs} \left( \frac{V_i}{100} \right)^2 \text{ lb} . \quad \dots \dots \dots (6)$$

A point that may be noted in passing is that  $P_s$  increases with  $K$ , the gearing between the total aileron deflection and the stick. Hence, the advantage of the smaller hinge moments obtained for a given rolling moment with small chord controls at large deflections is to some extent reduced by the greater gearings required between the control deflection and the stick, unless correspondingly large angular movements of the stick are permitted. The maximum stick movement of  $\pm 30$  deg assumed for the purpose of this example is, in fact, rather large.

The values of  $P_s/(V_i/100)^2$ , corresponding to values of  $C_l$  for a pair of ailerons ranging from 0.02 to 0.05, have been calculated, using equation (6) and the measured values of  $C_l$  and  $C_{hs}$  for the various aileron gearings combined with the balance tab settings of 0 and  $\pm 20$  deg. The results have been plotted in Fig. 26. The curves bring out clearly the point already noted, namely that at the smaller values of  $C_l$  there is nothing to gain in adopting a double aileron, but at higher values of  $C_l$  the double aileron shows up to great advantage, with the inter-aileron gearing 2.0 requiring appreciably smaller stick forces than the inter-aileron gearing 1.0. The relative falling-off in the effectiveness of the balance tab at the higher values of  $C_l$  is also to be noted.

\* Assuming the aircraft has to function as a fighter, then a high rate of roll will be desirable at high speeds, and to reach the rate of roll required a  $C_l$  of about 0.05 is again necessary. However, this high-speed case need not be taken too seriously here, since at high speeds the flaps would be retracted, and it should be possible to supplement the ailerons by additional ailerons on the flapped part of the wing, giving a control span and area more like that of a normal aircraft.

It is believed that a stick force of about 30–40 lb is the most that should be required of a pilot applying full aileron control. In the most favourable case illustrated in Fig. 26, when  $d\xi_2/d\xi_1 = 2.0$  with a balance tab setting of  $\pm 20$  deg, the pilot would need to exert about 70 lb at 150 ft/sec (100 m.p.h. approx.) to achieve a  $C_l$  of 0.05 and a force of 45 lb would be needed to achieve a  $C_l$  of 0.04.

It is clear, therefore, that some additional balance is necessary before the control would be acceptable. It is true that the example considered represents a fairly severe test, the aileron span is only 22 per cent of the wing span, and the aileron area is only 3.85 per cent of the wing area; what this means can be gauged from the fact that a  $C_l$  of 0.05 requires a local sectional lift coefficient increment of about 1.0 due to the aileron deflection. Nevertheless, for high-lift aircraft aileron spans greater than about 25 per cent of the wing span are not likely to be considered, and the possible relief in stick force due to increasing the aileron span from 22 per cent to 25 per cent of the wing span is slight. The possibilities of additional forms of balance must therefore be considered.

5.22. *Plain ailerons with spoilers.*—Comparing Fig. 8 and Fig. 12 it will be seen that the spoilers cause an appreciable reduction in the stick moment for small values of  $C_l$ , but this reduction disappears for a value of  $C_l$  of about 0.04 (from a pair of ailerons), above that value the spoilers have a negligible effect. The favourable effect of the spoilers arises presumably from the increase in the rolling moment that they cause at small to moderate aileron deflections. Therefore, for ailerons of more normal span requiring smaller deflections to give the required rolling moment, it is clear that a spoiler may prove a very effective device for reducing the hinge moment and boosting the rolling moment; the use of spoilers might well be worth considering for such cases\*. We have so far left out of consideration the effect of the spoilers in increasing the effectiveness of an internal pressure balance, this will now be discussed.

5.23. *Pressure measurements with and without spoilers.*—Some representative results for the pressure coefficients measured above and below the seals of the aileron gaps at the points A, B, C and D (see Fig. 1b), in the absence of spoilers, are shown in Figs. 13 to 18. The pressure coefficients are shown plotted against total control deflection ( $\xi_1 + \xi_2$ ) for the various inter-aileron gearings  $d\xi_2/d\xi_1$  considered. It will be noted that at the larger angular deflections there is little to choose between the gearings 1.0 and 2.0 as far as the pressures available for internal balance are concerned. As might be expected, for small angular deflections the largest pressure difference across the seal of the front aileron (*i.e.*, between A and B) is generally produced with  $d\xi_2/d\xi_1 = 0$ , *i.e.*, with the 0.2c single aileron; and across the seal of the rear aileron (*i.e.*, between C and D) the largest pressure difference is generally produced with  $d\xi_2/d\xi_1 = \infty$ , *i.e.*, with the 0.15c single aileron. Again, as might be expected, the balance tab reduces to some extent the pressure differences across both seals.

Some representative pressures measured with the spoilers present are shown in Figs. 19 and 20. Comparing Fig. 13 and Fig. 19 and also Fig. 14 and Fig. 20, it will be seen that the spoilers cause an appreciable increase in the pressure differences across the front seal up to a total angular movement of about 25 deg (corresponding to a value of  $C_l$  for a pair of ailerons of about 0.035); for larger aileron movements there is no gain in the pressure difference across the seal due to the spoilers. In every case the spoilers considerably reduce the pressure difference across the seal of the rear aileron gap; presumably this is because of the reduction in pressure behind a spoiler. We can again conclude, therefore, that there is nothing to be gained by using a spoiler on a small span aileron required to operate at large angles in order to provide a rolling moment of the order of 0.05. However, for ailerons of more normal span and, therefore, operating at smaller control angles, the use of a spoiler offers considerable possibilities.

\* It is worth noting that some American tests have demonstrated that spoiler placed ahead of an aileron provides an effective combination (Laitone, 1944)<sup>5</sup>. A critical discussion is given by Thomas in Ref. 6.

5.24. *Stick forces with internal pressure balance, with and without balance tabs.*—5.241. *Application of pressure measurements.*—An arrangement of the kind visualised, incorporating internal pressure balances, is illustrated in Fig. 7b. The reasons for considering this arrangement are set out in Appendices I and II. It is assumed that there is a shrouded nose balance of length  $l_1$  ahead of the front aileron and across this balance acts the pressure difference ( $P_A - P_B$ ) between the pressures measured at A and B. The front aileron is hollow and divided into two compartments by a flexible seal connecting the hinge of the front aileron to that of the rear, each compartment being vented to the air outside at the upper and lower ends of the rear aileron gap. There is no nose balance to the rear aileron, for although a nose balance lightens the rear aileron hinge moment it makes the front aileron hinge moment heavier, and it is shown in Appendix II that the latter effect in general outweighs the former. The seal is required, however, to allow the pressure difference ( $P_C - P_D$ ) to operate on the internal walls of the front aileron and so increase the balance. It is assumed that the length of these internal walls  $l_2$  is equal to the distance between the front and rear hinges; this need not be exactly true, but for the purpose of illustration it is near enough to what is practicable.

Assuming that the pressures on the nose balance and internal walls are constant, then the change in the moment about the first hinge due to these pressures is

$$\Delta H_1 = \left\{ (p_A - p_B) \frac{l_1^2}{2} \cdot b_a + (p_C - p_D) \frac{l_2^2}{2} \cdot b_a \right\} \cdot \frac{1}{2} \rho V^2,$$

where  $b_a$  is the span of the aileron.

The corresponding change in  $C_{h1}$  is therefore

$$\begin{aligned} \Delta C_{h1} &= \Delta H_1 / \frac{1}{2} \rho V^2 S_1 c_1, \\ &= \left\{ \frac{(p_A - p_B)}{2} \left( \frac{l_1}{c_1} \right)^2 + \frac{(p_C - p_D)}{2} \left( \frac{l_2}{c_1} \right)^2 \right\}. \quad \dots \quad \dots \quad \dots \quad \dots \quad (7) \end{aligned}$$

There is no change in  $C_{h2}$  due to the pressure balances.

Hence, by equation (4), the corresponding change in the stick hinge-moment coefficient is

$$\Delta C_{hs} = \left\{ (p_A - p_B) \left( \frac{l_1}{c_1} \right)^2 + (p_C - p_D) \left( \frac{l_2}{c_1} \right)^2 \right\} / 2 \left( 1 + \frac{d\xi_2}{d\xi_1} \right). \quad \dots \quad \dots \quad (8)$$

From a drawing of the mean aerofoil section in the region of the aileron on the model tested the maximum permissible lengths for this section of the nose balance for the aileron gearings  $d\xi_2/d\xi_1 = 0, 1$  and  $2$  were determined; they are summarised in the following table:—

TABLE 4

Inter-aileron Gearing $d\xi_2/d\xi_1$	Maximum permissible value of $l_1/c_1$	Per cent balance* <i>i.e.</i> , $100 l_1/(c_1 + l_1)$
0	0.15	11½
1	0.29	22½
2	0.45	31

At first sight it would seem that the considerable increase of the permissible nose balance length with increase of inter-aileron gearing would be accompanied by a correspondingly large reduction in the stick force. However, an opposing effect, which is less obvious but very important, derives

\* Throughout this report the percentage balance has been defined in terms of the chord length aft of the hinge plus the balance length. It is now more usual to define it in terms of the chord length aft of the hinge.

from the fact that an increase in the inter-aileron gearing means an increase in the factor  $(1 + d\xi_2/d\xi_1)$  in the denominator of the expression for  $C_{hs}$  in equation (8). In other words, with increase of inter-aileron gearing the rate of movement of the nose or pressure balance with stick movement decreases and hence the work performed by the nose or pressure balance for a given increment of stick movement is reduced, and therefore the balancing effect on the stick force is reduced.

5.242. *Stick moments and forces.*—The resulting stick-moment coefficients  $C_{hs}$  for the three inter-aileron gearings 0, 1.0 and 2.0, with the nose balances given in the above table, are plotted against  $C_l$  in Figs. 21, 22 and 23. Comparing these results with those given in Figs. 8, 9 and 10 it will be seen, as explained in the previous section, that the effect of the pressure balance increases relatively slowly with inter-aileron gearing. In the best case with  $d\xi_2/d\xi_1 = 2.0$  it provides a reduction of the stick-hinge moment of about 25 per cent for a rolling-moment coefficient of 0.05 (from a pair of ailerons).

It is possible, of course, that with a different wing section larger values of the nose-balance length  $l_1$  would be permissible with a given aileron gearing. To cover such possibilities, therefore, similar calculations have been made of the resulting stick-moment coefficient for the inter-aileron gearing 2.0 with nose balances of 40 and 50 per cent (*i.e.*,  $l_1/c_1 = 0.67$  and 1.0 respectively). The results of these calculations are illustrated in Figs. 24 and 25. It will be seen that with these larger nose balances the corresponding stick moment reductions become very considerable. For a  $C_l$  of 0.05 (from a pair of ailerons) the reduction of stick moment for zero tab setting is about 50 per cent due to a 40 per cent nose balance and almost 100 per cent with a 50 per cent nose balance.

Again, to illustrate these results in a more concrete form, the corresponding values of  $P_s/(V_i/100)^2$  for the hypothetical aircraft detailed in section 5.21 have been calculated for  $C_l$ 's varying from 0.02 to 0.05 and the results are shown in Fig. 27. At 150 ft/sec (100 m.p.h. approx.) the stick forces required for a  $C_l$  of 0.05 for the aileron gearings 1.0 and 2.0 are summarised in the following table:—

TABLE 5

$\frac{d\xi_2}{d\xi_1}$	Tab balance angle deg	Nose pressure balance per cent	Stick force (lb) for $C_l = 0.05$		
			$\alpha = 0^\circ$	$\alpha = 6^\circ$	$\alpha = 12^\circ$
1	0	0	117	106	109
1	$\pm 20$	0	105	96	89
1	0	$22\frac{1}{2}$	103	97	94
1	$\pm 20$	$22\frac{1}{2}$	86	65	70
2	0	0	109	101	89
2	$\pm 20$	0	90	80	72
2	0	31	90	73	77
2	$\pm 20$	31	64	55	52
2	0	40	70	60	58
2	$\pm 20$	40	51	43	40
2	0	50	27	24	25
2	$\pm 20$	50	8	7	0

Taking a figure of the order of 30–40 lb as the largest the pilot should normally be expected to exert, then it is clear that, at the most, only the last three arrangements tested are possibly acceptable. Thus, either a balance tab plus upwards of 40 per cent nose balance, or a 50 per cent nose balance is required. However, it is doubtful whether a 50 per cent nose balance is possible in wing sections of thickness less than about 15 per cent, but a nose balance of 40 per cent may be possible in a low-drag section of thickness 12 per cent or more. It should be noted that the

50 per cent pressure balance offers an embarrassing degree of overbalance for small aileron movements (Fig. 25), this may rule out such a large pressure balance unless combined with a small anti-balance tab of variable gearing.

Of the inter-aileron gearings tested it is clear that the gearing 2.0 is the best. It is, of course, possible that it is not the true optimum gearing, but it is doubtful whether the results obtained with it can differ very seriously from those of the optimum gearing. If the optimum gearing is less than 2.0 then it must lie very near 2.0 since the results obtained with the gearing 1.0 are not very much worse than those with gearing 2.0. Nor can the optimum gearing be very much greater than 2.0 since the arrangement would then differ little from the single 0.15c aileron.

6. *Conclusions.*—The main conclusions of these tests may be summarised as follows:—

- (1) A double aileron will give much the same rolling moment as a single aileron of the same chord at the same total deflection.
- (2) When total deflections of magnitude not greater than about 20 deg are required (as for ailerons of normal span and area) there is nothing to be gained by using a double aileron.
- (3) Where large total deflections of the order of 50 deg are required, as for small span ailerons used in conjunction with high-lift flaps, the double aileron offers definite advantages over the single aileron, and an inter-aileron gearing ( $d\xi_2/d\xi_1$ ) in the region of 2.0 is probably the optimum.
- (4) With this gearing the following table gives the stick forces required to produce a rolling moment of 0.05 at 100 m.p.h. for a double aileron of chords 0.2c and 0.15c and span 0.22s on an aircraft of span 50 ft, for which the length of the stick from the handle to pivot is 2 ft 6 in., the total angular movement of the stick is  $\pm 30$  deg and that of the aileron is  $\pm 50$  deg. The tab balance is 0.05c in chord and has the same span as the aileron:—

Tab angle, deg	Percentage nose balance	Stick force (lb) required for $C_l = 0.05$		
		$\alpha = 0^\circ$	$\alpha = 6^\circ$	$\alpha = 12^\circ$
0	0	109	101	89
$\pm 20$	0	90	80	72
0	31	90	73	77
$\pm 20$	31	64	55	52
0	40	70	60	58
$\pm 20$	40	51	43	40
0	50	27	24	25
$\pm 20$	50	8	7	0

- (5) Assuming that a stick force much greater than about 30 to 40 lb cannot be tolerated, it will be seen that either the tab balance plus a nose balance of 40 per cent or more or a nose balance approaching 50 per cent is necessary. For the model tested only a 31 per cent nose balance was possible, but for low drag sections of thickness 12 per cent or more, or normal sections of thickness greater than about 15 per cent these larger nose balances required may be possible.
- (6) Unless both the tab balance and a nose balance of about 50 per cent are possible, then adequate rolling moments to produce high rates of roll at high speeds will be out of the question with the small span ailerons tested—at high speeds the control would then have to be supplemented by an additional aileron capable of operating when the flap is retracted.

- (7) To take full advantage of the small hinge moments of the double aileron at large control angles, the maximum angular movement of the stick should be correspondingly increased. It should also be noted that, although increasing the inter-aileron gearing enables a larger degree of nose balance to be used, this is to some extent counter-balanced by the increase in the gearing between the stick and the nose balance movement.
- (8) A spoiler operating just behind the first hinge, designed to go down on the down-going aileron and up on the up-going aileron, provides an appreciable reduction of the hinge moment for a given rolling moment for control movements less than about 20 deg. For larger control movements the effect of the spoiler becomes negligible. The spoiler cannot therefore be recommended for use with small span ailerons required to operate at large control angles, but its possibilities on ailerons of more normal span are worth investigating.

---

#### REFERENCES

<i>No.</i>	<i>Author</i>	<i>Title, etc.</i>
1	R. I. Sears and P. E. Purser ..	Wind Tunnel Investigation of Control-surface Characteristics XIV—NACA 0009 Airfoil with a 20 per cent Chord Double Plain Flap. N.A.C.A. A.R.R. No. 3F29. June, 1943. A.R.C. 7215.
2	R. B. Liddell .. .. .	Wind Tunnel Investigation of Control-surface Characteristics XIX—A Double Flap with an Overhang and an Internal Aerodynamic Balance. N.A.C.A. A.C.R. No. L4F23. June, 1944. A.R.C. 8430.
3	S. B. Gates and H. H. B. M. Thomas	Comments on the Use of Small Chord Flaps of Large Deflection for Controls. A.R.C. 7417. November, 1943.
4	A. S. Hartshorn .. .. .	Theoretical Relationship for a Wing with Unbalanced Ailerons. R. & M. No. 1259. April, 1929.
5	E. V. Laitone .. .. .	An Investigation of the High Speed Lateral Control Characteristics of a Spoiler. N.A.C.A. A.C.R. No. 4C23. A.R.C. 8020. 1944.
6	H. H. B. M. Thomas .. .. .	Comments on the Above. A.R.C. 8036. July, 1944.

---

## APPENDIX I

### *Comparison With Proposed American Linkage*

In Ref. 2 a description is given of a method of linkage which is illustrated in Fig. 7a. This differs from the system envisaged in this note in so far as in the American system the rear aileron is pivoted in bearings fixed to the wing structure, whilst our results refer to a system where the rear aileron is pivoted in bearings fixed in the front ailerons. A linkage for the type of system we have considered is illustrated in Fig. 7b for comparison with the American linkage. It is obviously desirable to decide which of these two methods is the more promising. It is, however, impossible to make a strict comparison; the following discussion, based as it is on various simplifying assumptions, can only be regarded as indicative rather than conclusive.

The essentials of the two arrangements are sketched in Fig. 28. The two ailerons are the components AC and BD, in the American arrangement (a) AC is pivoted at A and BD is pivoted at B, where A and B are fixed points, whilst C, the point of intersection of AC and BD slides in a slot in AC. For the other arrangement (b) AC is pivoted at A and BD is pivoted at C', whilst B slides in a slot along AB. Let suffix *a* refer to arrangement (a) and suffix *b* to arrangement (b), and let  $H_s$  be the applied stick moment and  $\delta_s$  the stick angular movement. For the first stage of the argument we compare both arrangements having momentarily the same values of  $\xi_1$  and  $\xi_2$ . Then, adopting the notation of Fig. 28, we have for arrangement (a)

$$H_{sa} = h_{1a} \frac{d\xi_1}{d\delta_s} + h_{2a} \frac{d(\xi_1 + \xi_2)}{d\delta_s},$$

where  $h_{1a}$  is the moment of the aerodynamic forces on AC about A and  $h_{2a}$  is the moment of the aerodynamic forces on BD about B.

We assume that

$$\xi_1 + \xi_2 = K_1 \delta_s$$

and  $\frac{d\xi_2}{d\xi_1} = K_{2a}$ , say.

Then it follows that

$$\frac{H_{sa}}{K_1} = \frac{h_{1a}}{1 + K_{2a}} + h_{1a} \cdot \dots \dots \dots \dots \dots \dots \dots \dots \dots \dots \quad (9)$$

Similarly, for arrangement (b)

$$H_{sb} = h_{1b} \frac{d\xi_1}{d\delta_s} + h_{2b} \frac{d\xi_2}{d\delta_s},$$

where  $h_{1b}$  is the moment of the aerodynamic forces on AC and BD about A and  $h_{2b}$  is the moment of the aerodynamic forces on BD about C.

We have

$$\xi_1 + \xi_2 = K_1 \delta_s$$

and  $\frac{d\xi_2}{d\xi_1} = K_{2b}$ , say.

Then

$$\frac{H_{sb}}{K_1} = \{h_{1b} + h_{2b}K_{2b}\}/(1 + K_{2b}) \cdot \dots \dots \dots \dots \dots \dots \dots \quad (10)$$





## APPENDIX II

### *Effect of a Nose Balance on the Rear Aileron*

Considering now the arrangement (b), suppose the portion BC' is acting as a nose balance to the rear aileron. Then clearly it will help to reduce  $h_{2b}$  but it will increase  $h_{1b}$ , and it remains to determine whether such a balance is of benefit or otherwise as far as the stick force is considered.

Suppose the force on BC' is  $\Delta p \cdot y$ , say, acting at the mid-point of and normal to BC'. Then this will help to reduce  $h_{2b}$  by an amount equal to

$$\frac{\Delta p \cdot y^2}{2}$$

The corresponding increase of  $h_{1b}$  due to this force is

$$\Delta p \cdot y [y/2 + x \cos (\xi_1 + \xi_2)].$$

Hence, from equation (10) and the geometry of the arrangement the net increase in the stick force is proportional to

$$\frac{\Delta p \cdot y}{2} \left[ y + 2x \cos (\xi_1 + \xi_2) - \frac{x}{\cos (\xi_1 + \xi_2)} \right].$$

It follows that the nose balance on the rear aileron is of benefit or not according as

$$y + 2x \cos (\xi_1 + \xi_2) - \frac{x}{\cos (\xi_1 + \xi_2)} \text{ is } < \text{ or } > 0,$$

*i.e.*, according as

$$\sin \xi_1 \cdot \cos (\xi_1 + \xi_2) + \sin \xi_2 \cos 2 (\xi_1 + \xi_2) \text{ is } < \text{ or } > 0. \quad \dots \quad (16)$$

If  $d\xi_2/d\xi_1 = \infty$ , *i.e.*,  $\xi_1 = 0$  for all  $\xi_2$ , then this expression is  $\leq 0$  according as  $\xi_2 \leq 45$  deg, but this case is trivial, since  $y$  is zero, B and C coincide and no nose balance on the rear aileron is possible.

If  $d\xi_2/d\xi_1 = 2.0$ , then the expression becomes

$$\begin{aligned} & \sin \xi_1 \cos 3\xi_1 + \sin 2\xi_1 \cdot \cos 6\xi_1 \\ & = \frac{1}{2} \{ \sin 4\xi_1 - \sin 2\xi_1 + \sin 8\xi_1 - \sin 4\xi_1 \} \\ & = \sin 3\xi_1 \cdot \cos 5\xi_1. \end{aligned}$$

Hence, the expression  $\leq 0$ , according as  $\xi_1 \leq 18$  deg.

It is doubtful whether total aileron deflections greater than about 55 deg could be considered, since for such deflections there is a falling-off of control effectiveness with further deflection combined with a more rapid increase of hinge moment (particularly at high incidences). It follows that for the inter-aileron gearing of 2.0, the maximum value of  $\xi_1$  likely to be used is in the region of 18 deg. Hence, for this case, the nose balance on the rear aileron can be at the best of negligible effect and in general it is detrimental.

For  $\frac{d\xi_2}{d\xi_1} = 1.0$ , the expression becomes

$$\begin{aligned} \sin \xi_1 \cdot \cos 2\xi_1 + \sin \xi_1 \cdot \cos 4\xi_1 & = \sin 3\xi_1 - \sin \xi_1 + \sin 5\xi_1 - \sin 3\xi_1 \\ & = \sin 2\xi_1 \cdot \cos 3\xi_1. \end{aligned}$$

Hence, the expression  $\leq 0$  according as  $\xi_1 \geq 30$  deg, *i.e.*, according as the total deflection  $\geq 60$  deg. Therefore, for the same reasons as above we find the effect of nose balance on the rear aileron to be detrimental over the practical range of the total deflection.

For  $\frac{d\xi_2}{d\xi_1} = 0$ , the expression becomes

$$\sin \xi_1 \cos \xi_1,$$

and hence it is  $> 0$ , for  $\xi_2 < 90$  deg. It follows that the nose balance is detrimental.

It is clear from this survey of the effect of a nose balance on the rear aileron for various inter-aileron gearings that such a balance should not be adopted, unless control deflections greater than would appear desirable from the considerations are contemplated.

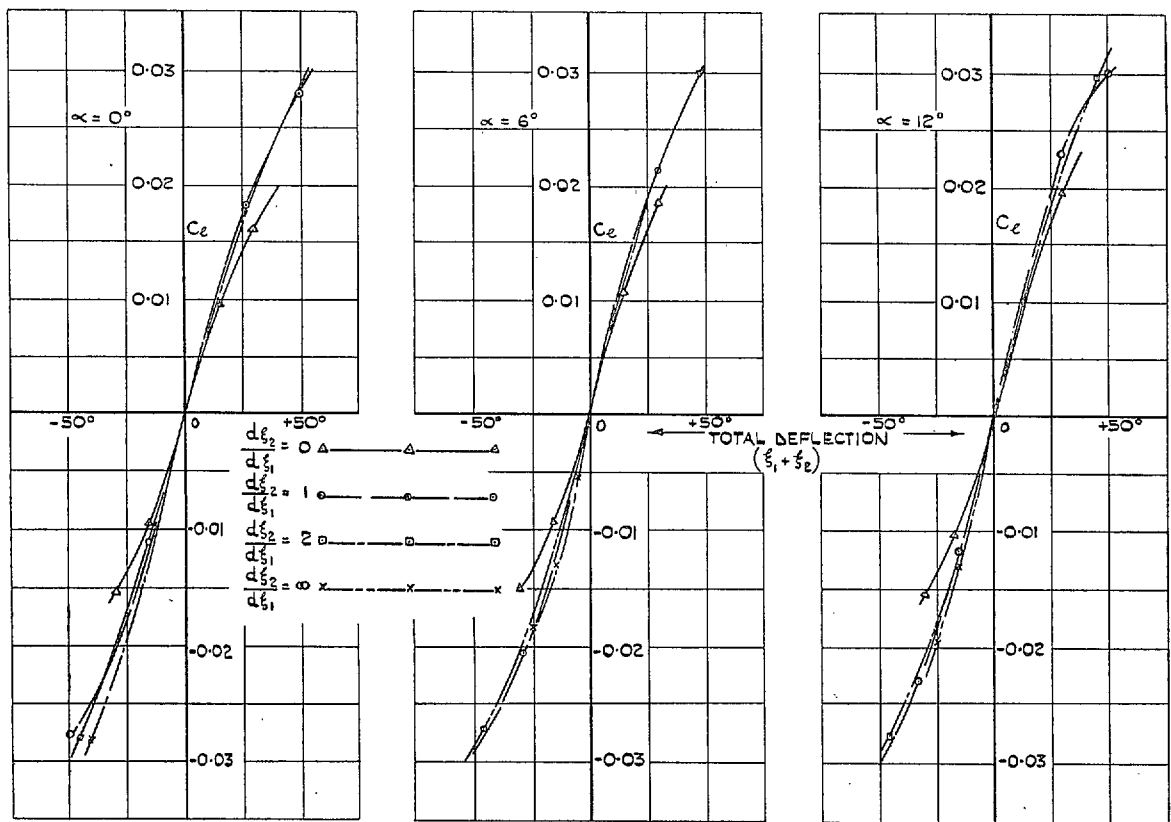

FIG. 2. Rolling moment versus aileron deflection.  $\xi_3 = 0$  deg.

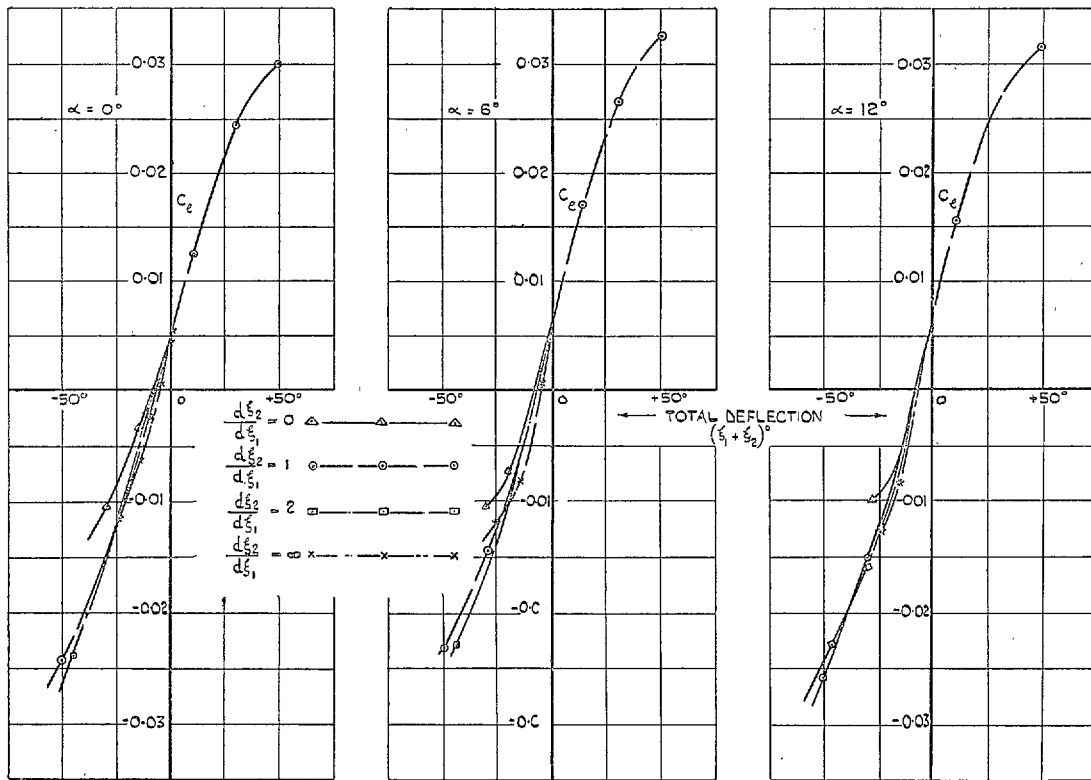

FIG. 3. Rolling moment versus aileron deflection.  $\xi_3 = 20$  deg.

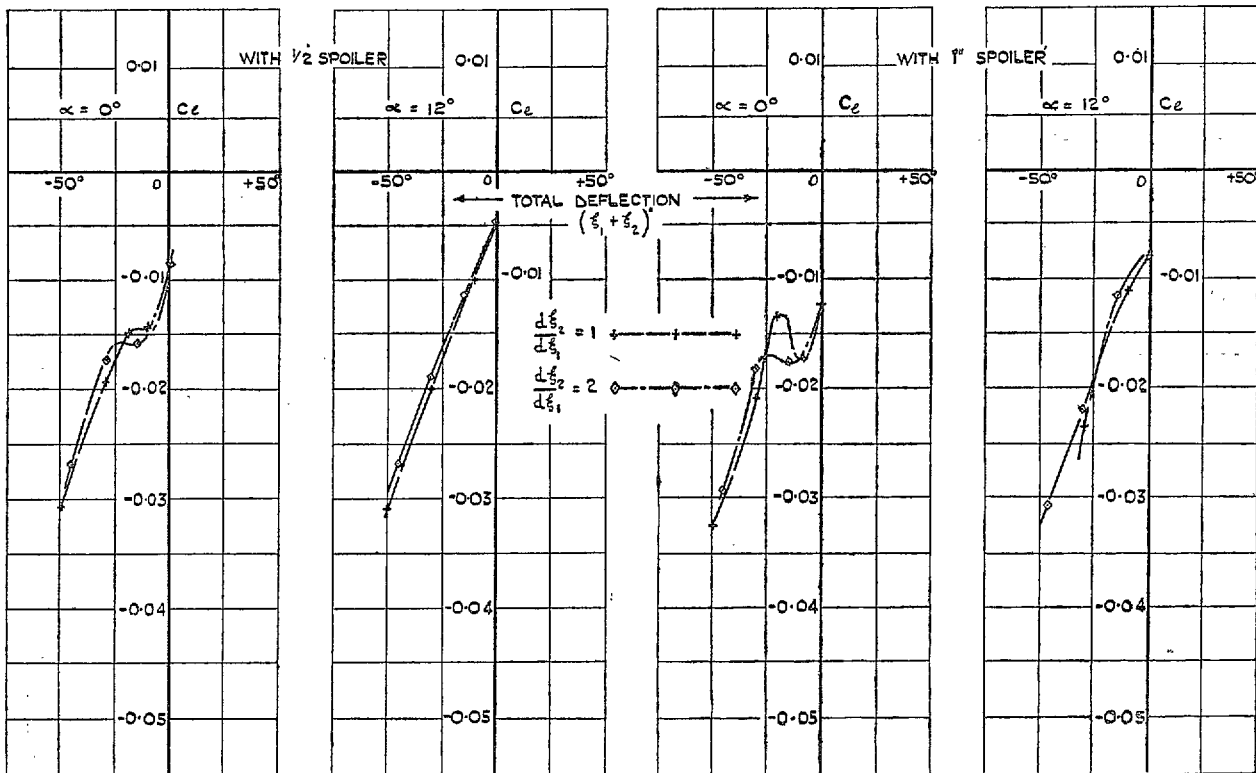

FIG. 4. Rolling moment versus aileron deflection, with spoilers.  $\xi_3 = 0$  deg.

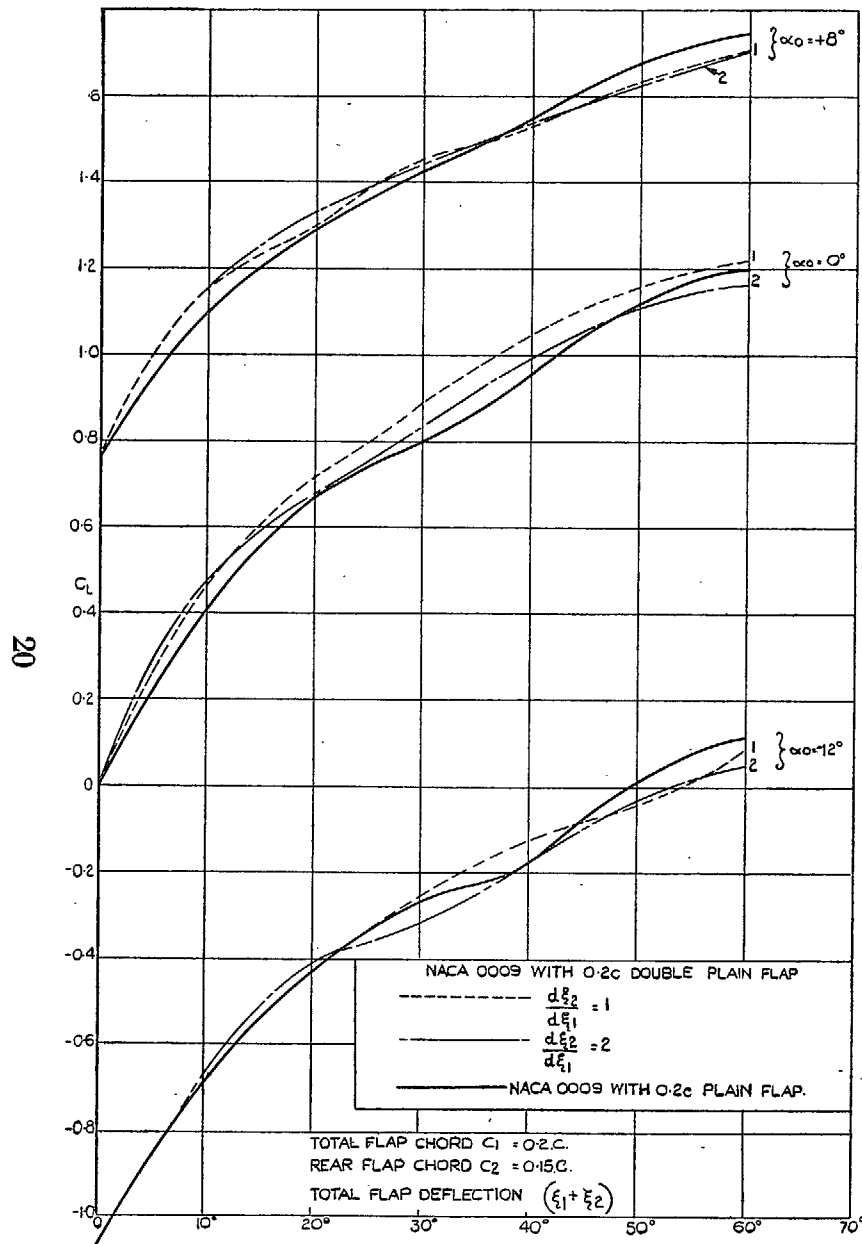

FIG. 5. Aerofoil section lift coefficient as a function of total flap deflection (Ref. 1). 0.2c double flap.

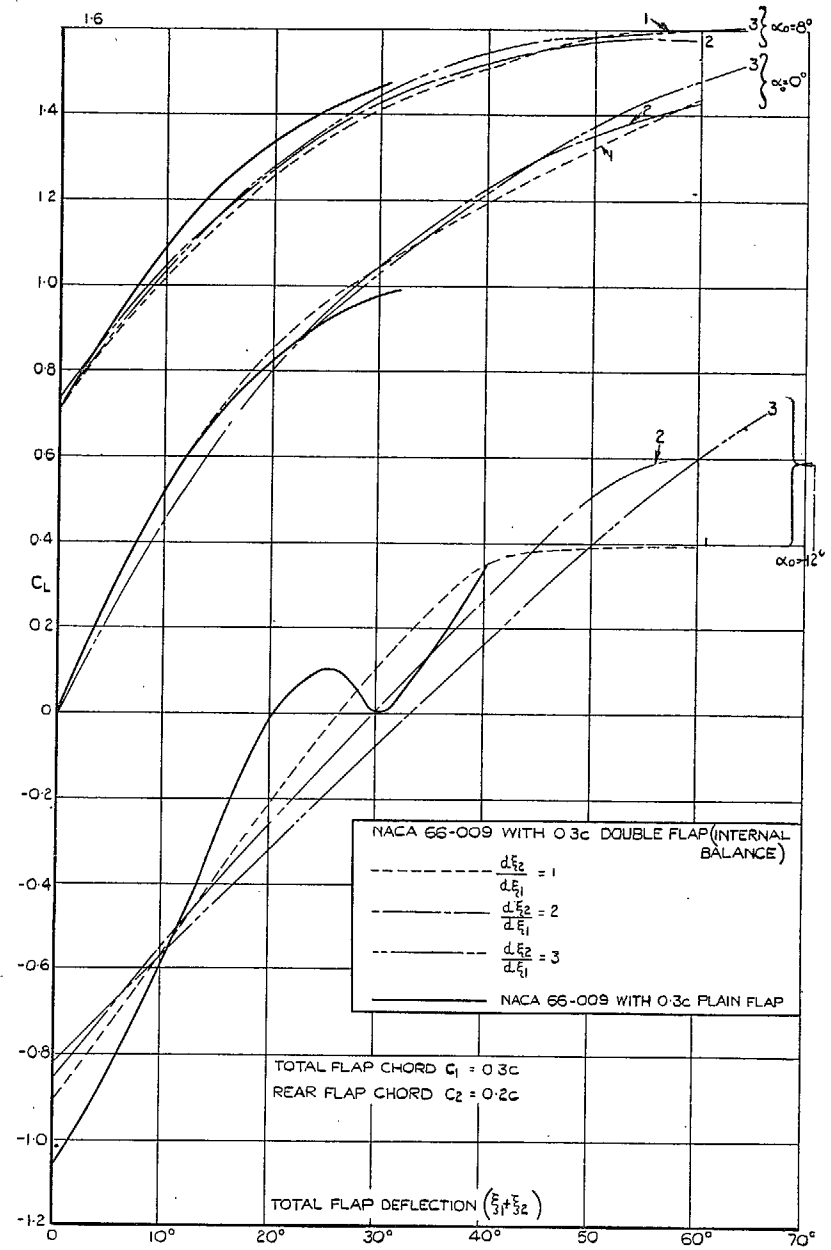
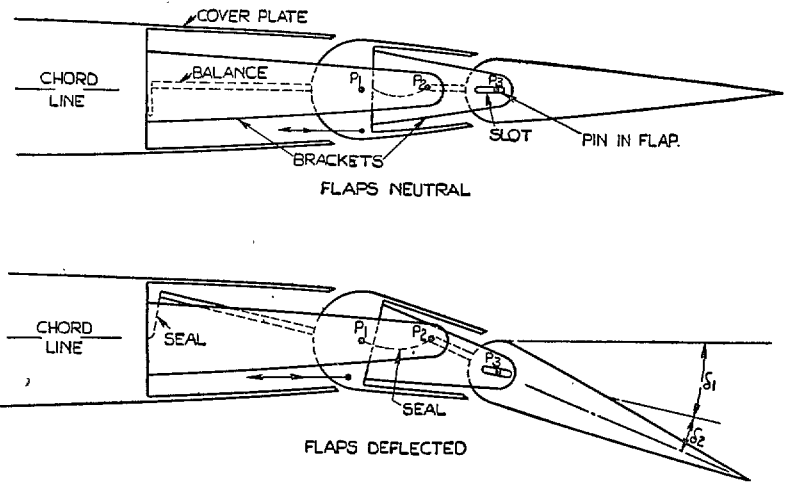
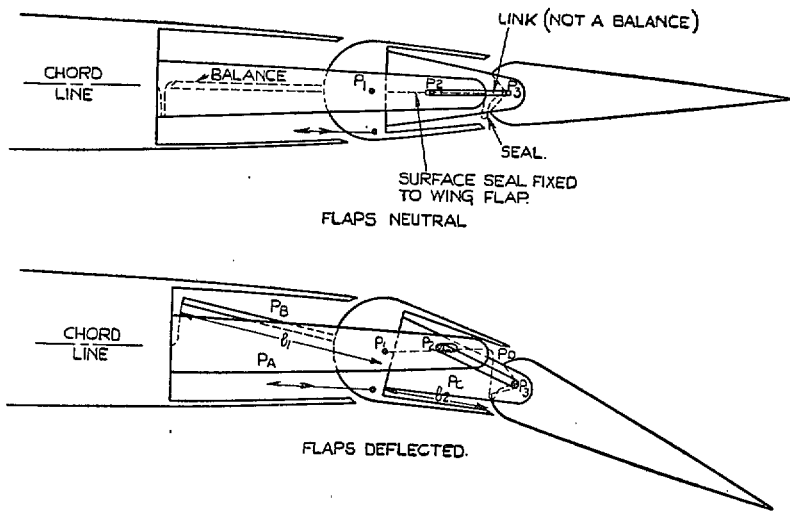

FIG. 6. Aerofoil section lift coefficient as a function of total flap deflection (Ref. 2). 0.3c double flap.



(a) AMERICAN FLAP ARRANGEMENT (REF. 2.)



(b) SUGGESTED ALTERNATIVE FLAP ARRANGEMENT.

FIG. 7.

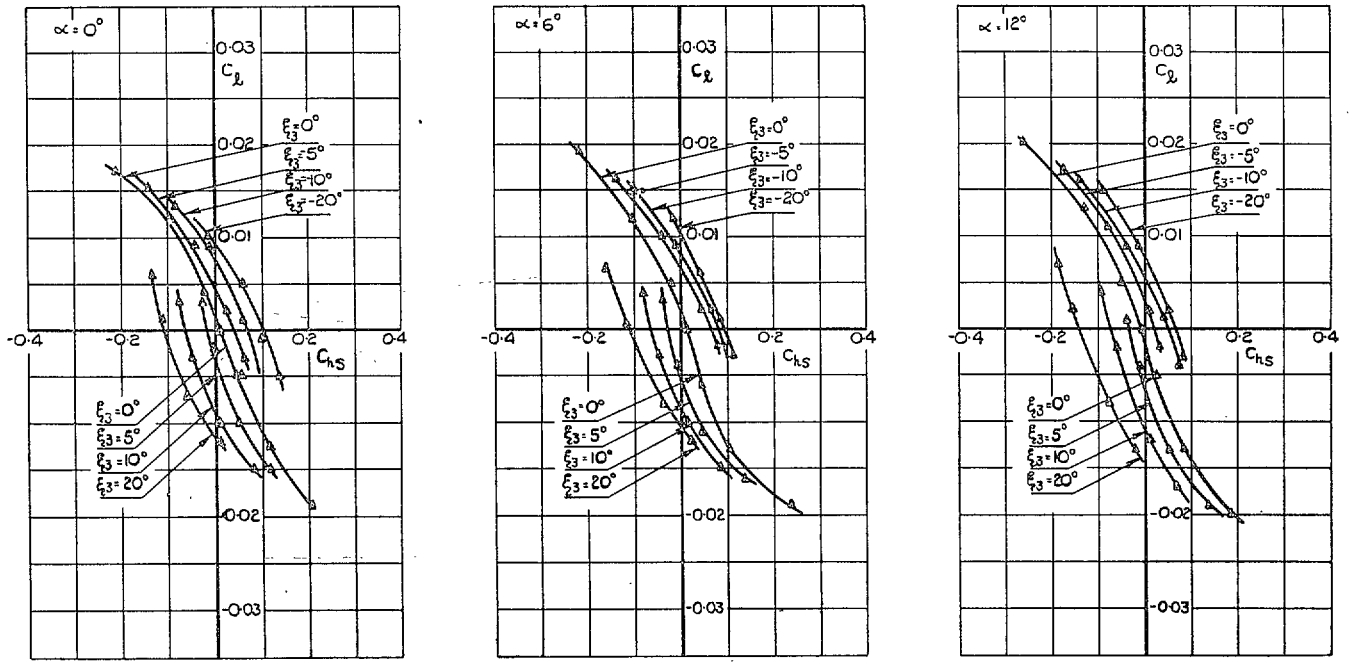

FIG. 8. Rolling-moment coefficient versus stick-moment coefficient.  $d\xi_2/d\xi_1 = 0$ .

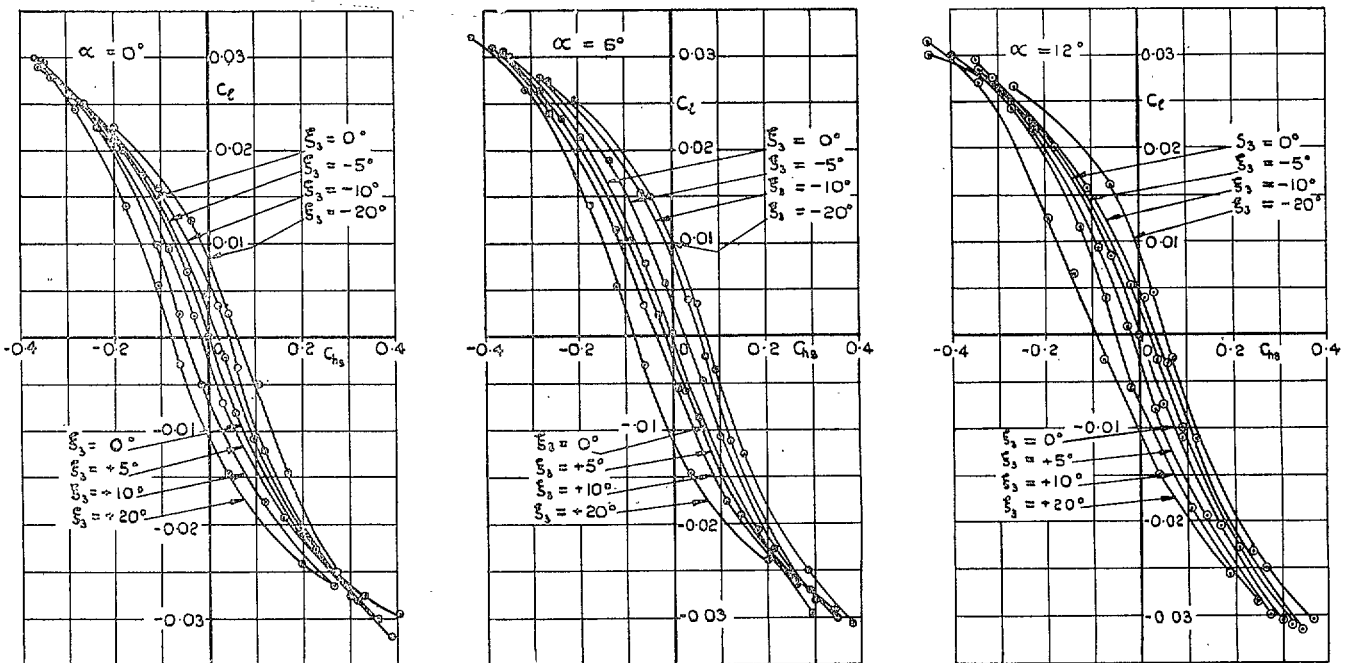

FIG. 9. Rolling-moment coefficient versus stick-moment coefficient.  $d\xi_2/d\xi_1 = 1$ .

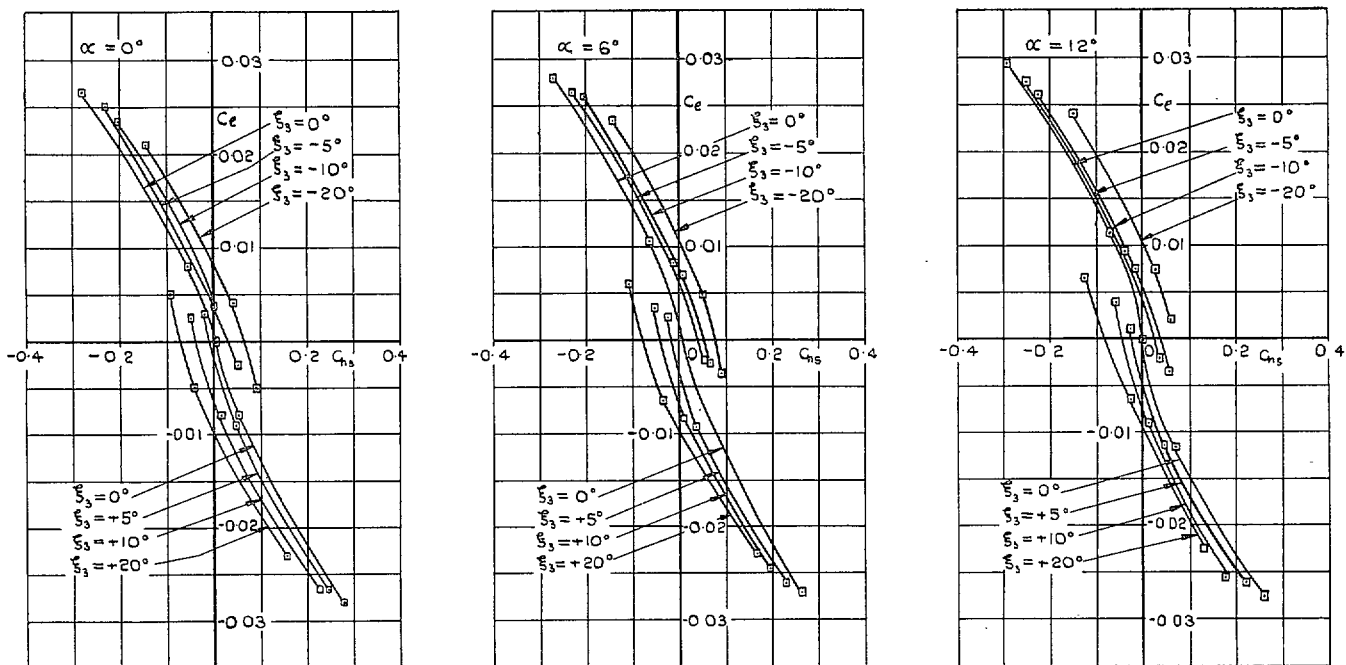

FIG. 10. Rolling-moment coefficient versus stick-moment coefficient.  $d\xi_2/d\xi_1 = 2$ .

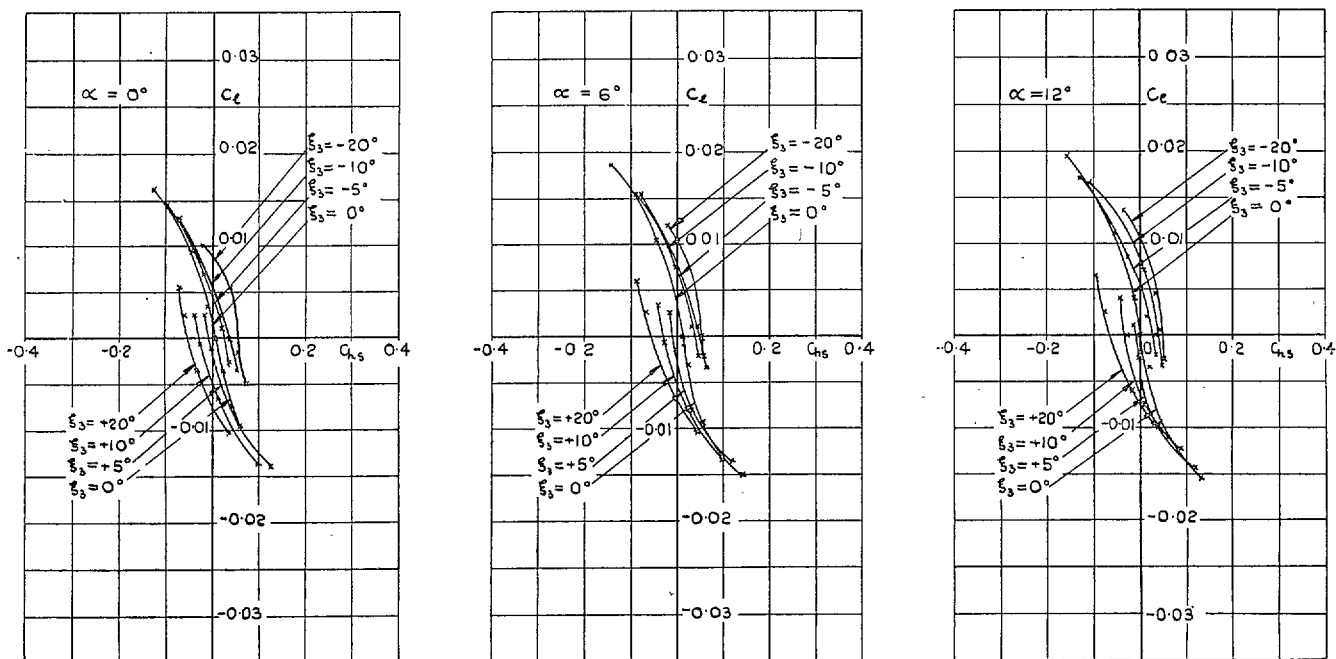

FIG. 11. Rolling-moment coefficient versus stick-moment coefficient.  $d\xi_2/d\xi_1 = \infty$ .



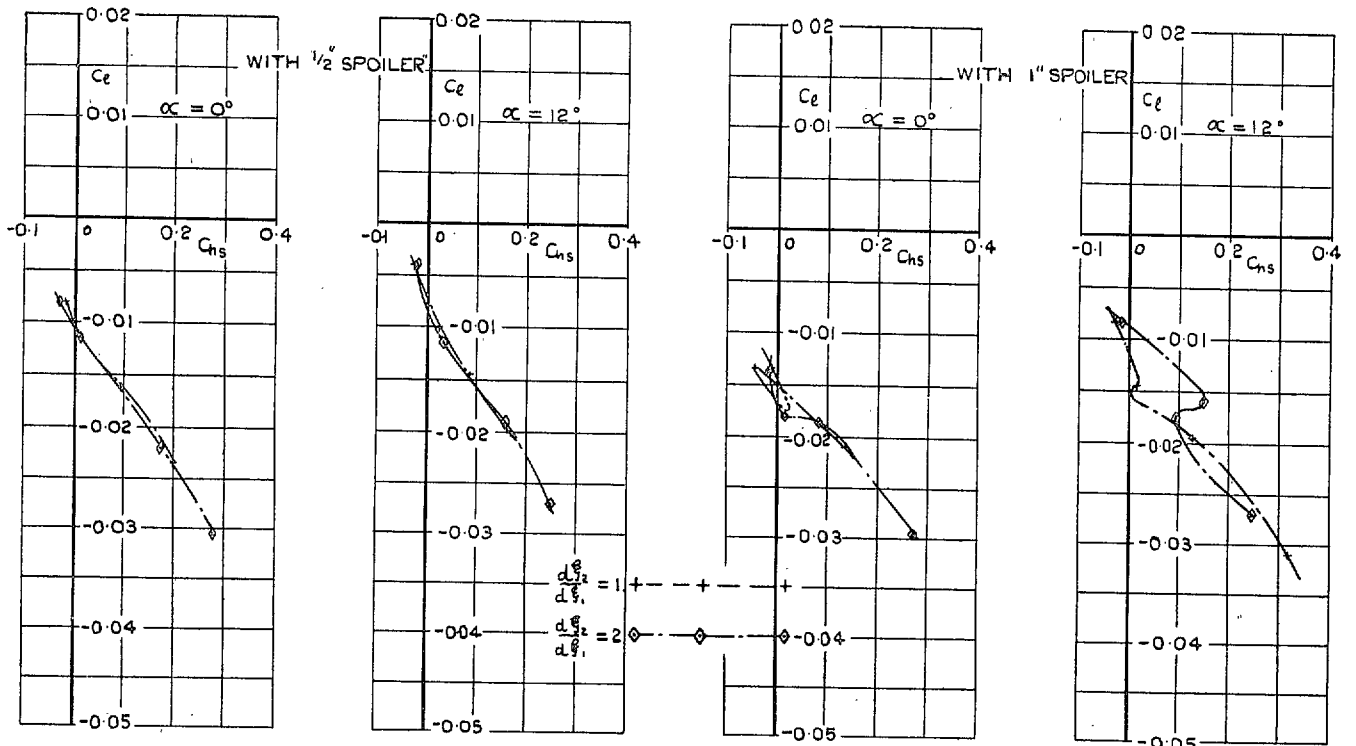

FIG. 12. Rolling-moment coefficient versus stick-moment coefficient, with spoilers.  $\xi_3 = 0$  deg.

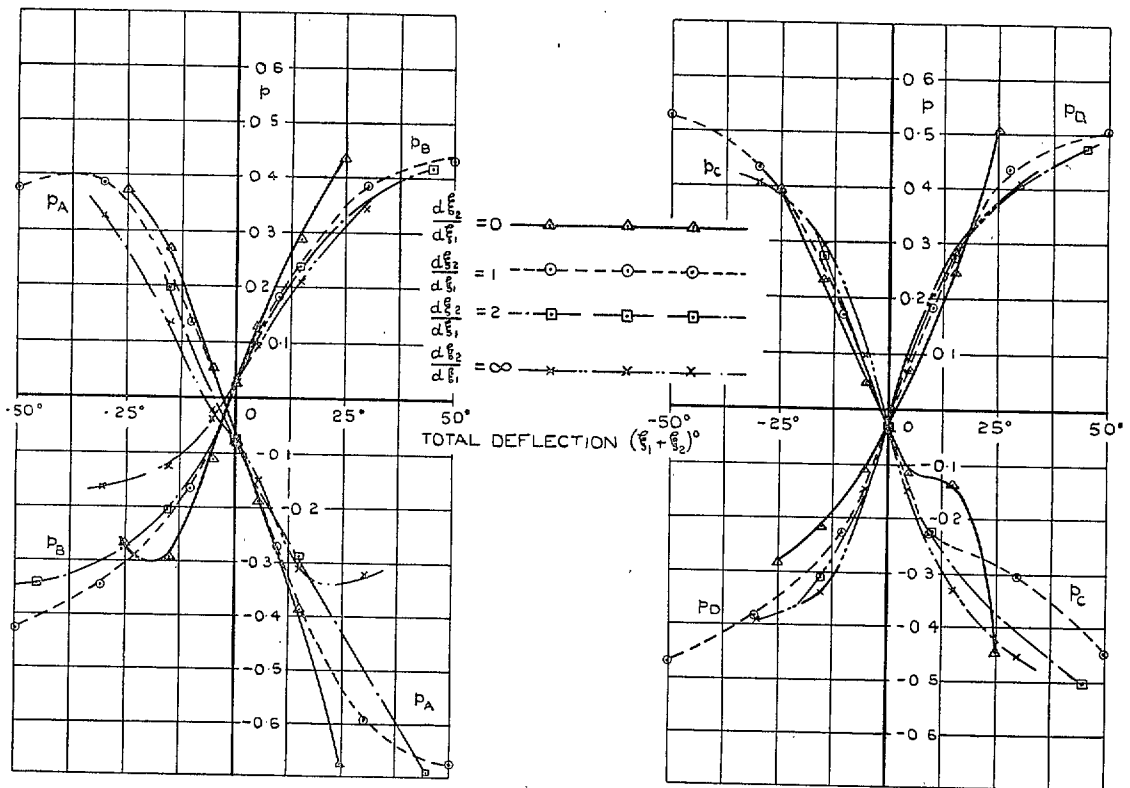

FIG. 13. Hinge pressures.  $\alpha = 0$  deg.  $\xi_3 = 0$  deg.

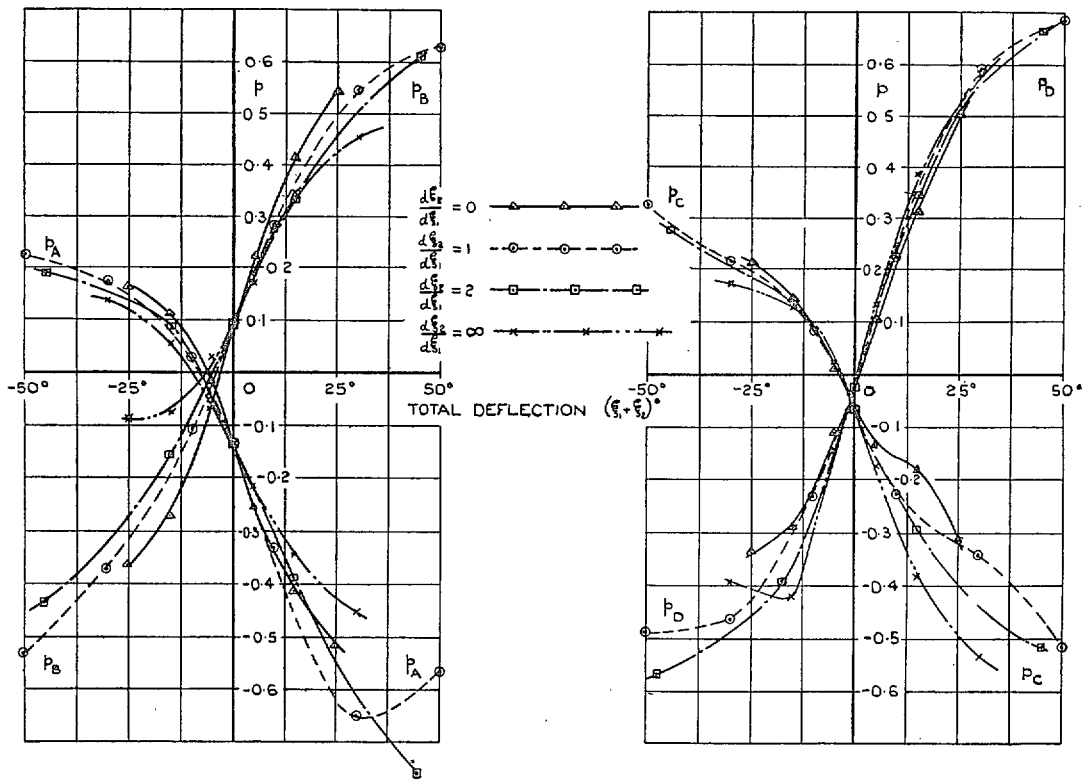

FIG. 14. Hinge pressures.  $\alpha = 12$  deg.  $\xi_3 = 0$  deg.

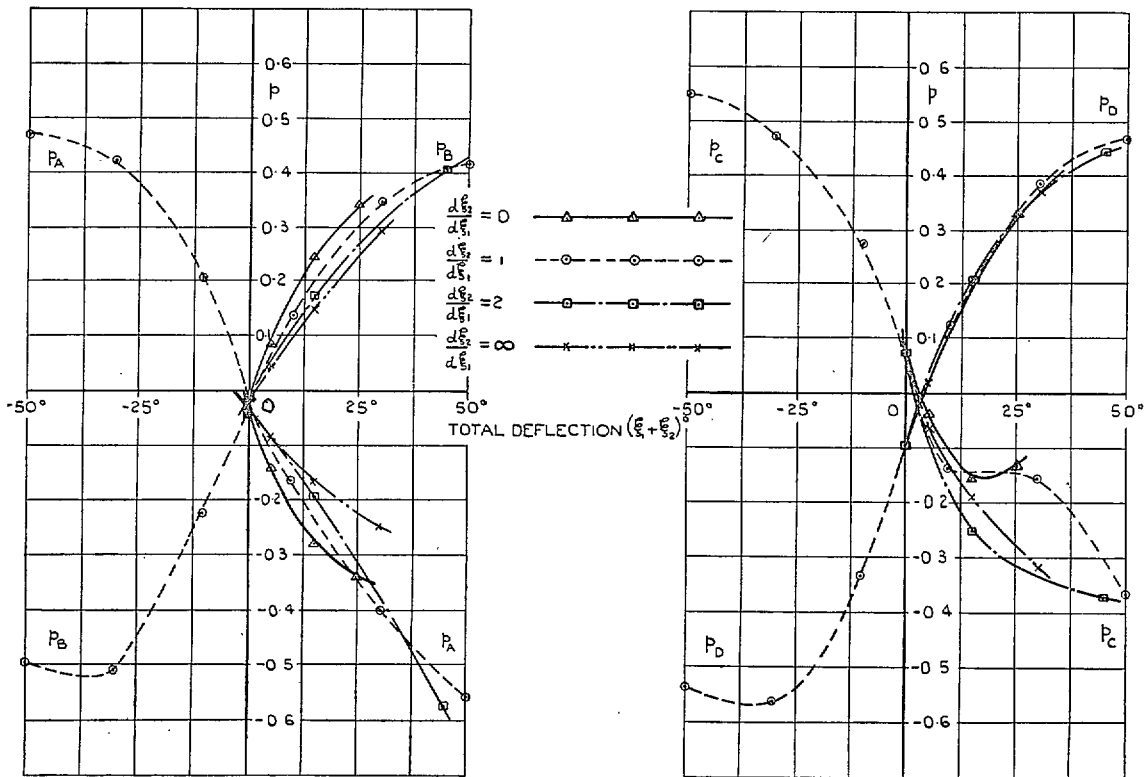

FIG. 15. Hinge pressures.  $\alpha = 0$  deg.  $\xi_3 = -20$  deg.

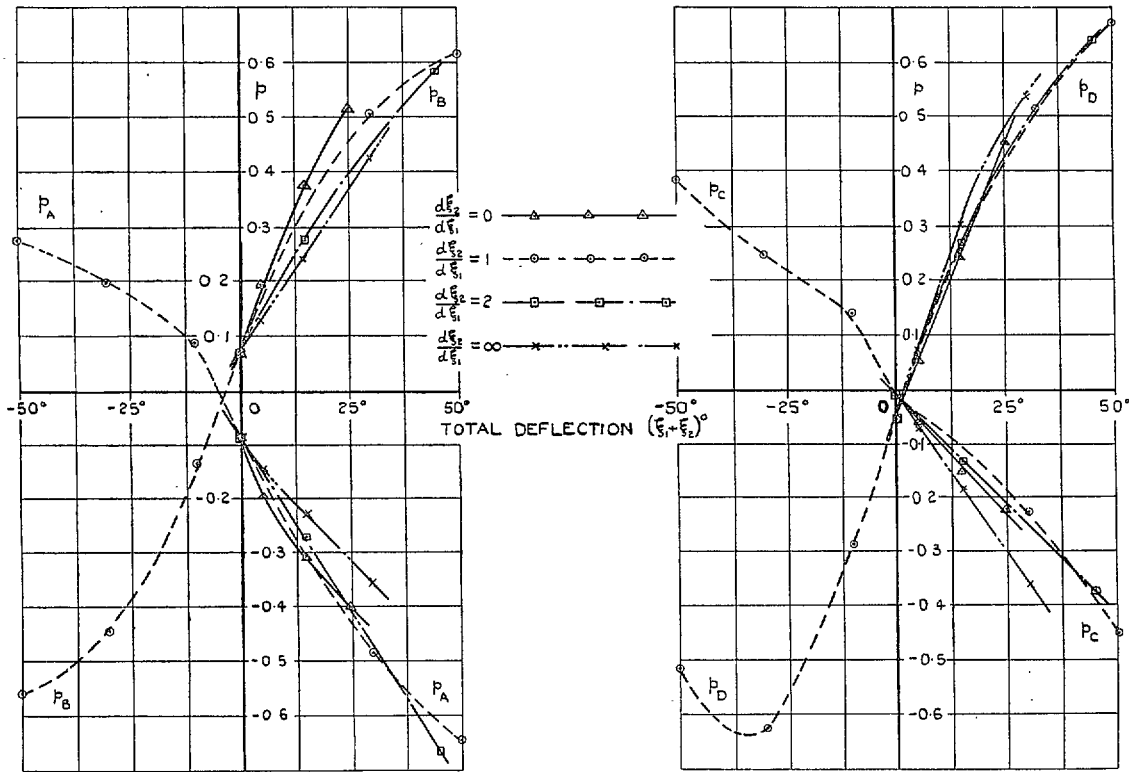

FIG. 16. Hinge pressures.  $\alpha = 12$  deg.  $\xi_3 = -20$  deg.

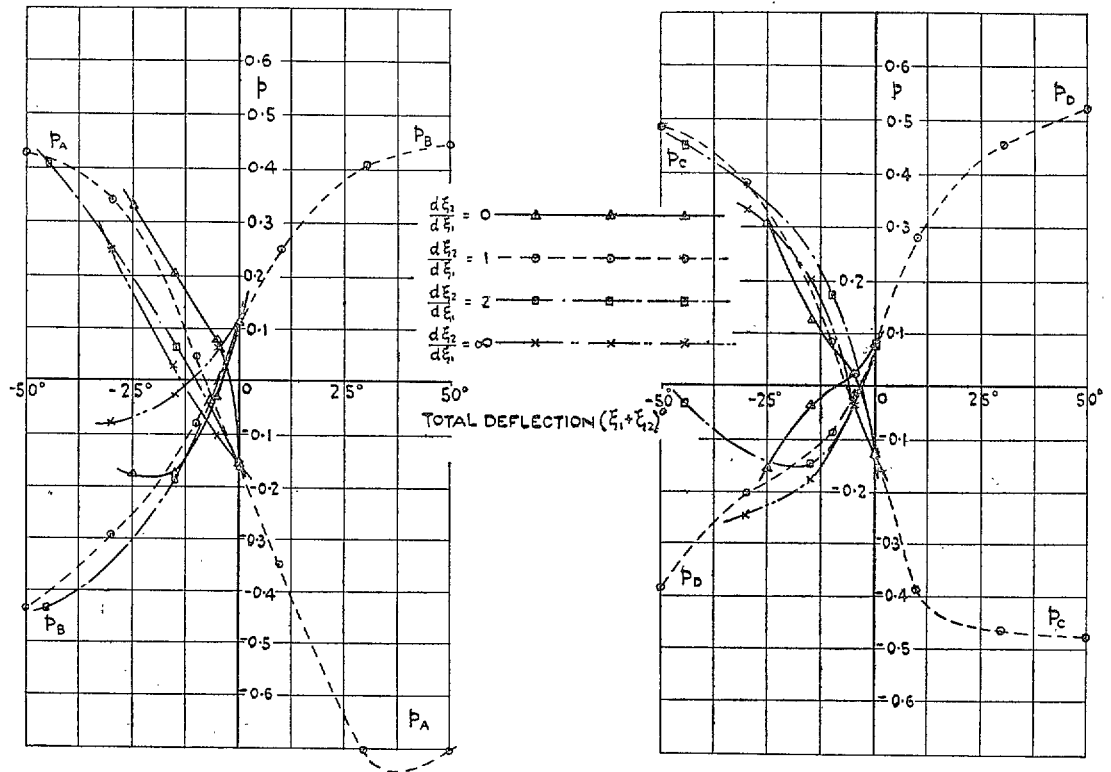

FIG. 17. Hinge pressures.  $\alpha = 0$  deg.  $\xi_3 = +20$  deg.

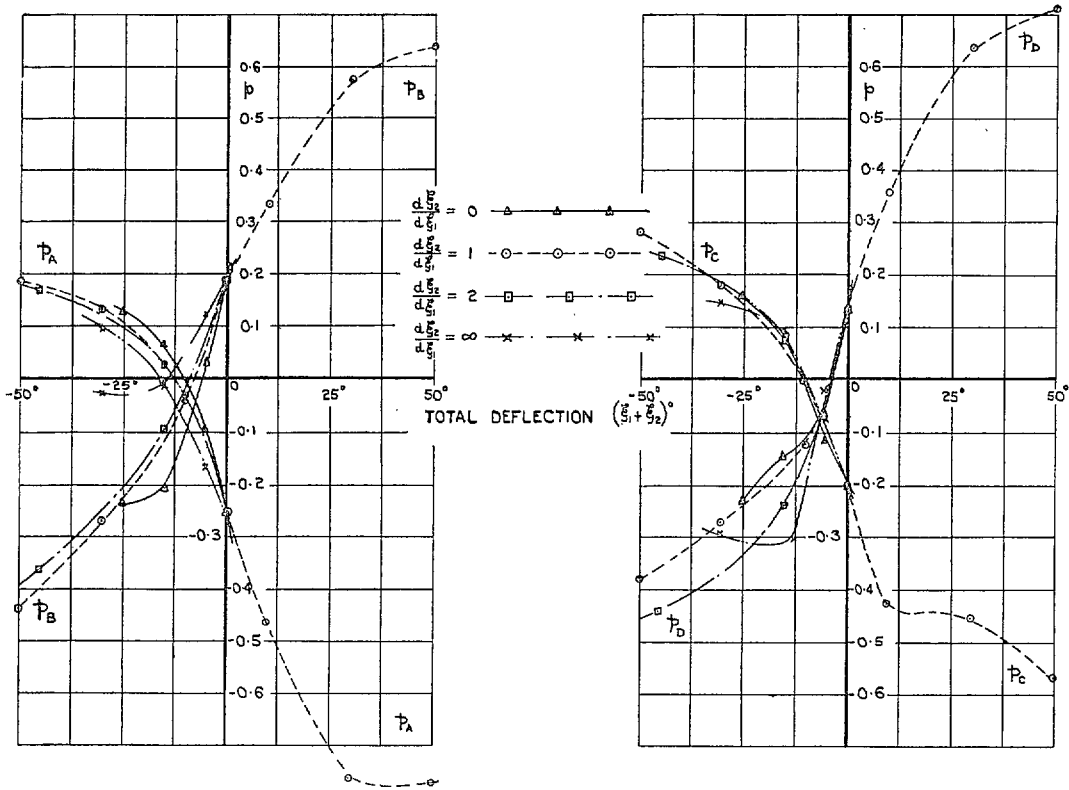

FIG. 18. Hinge pressures.  $\alpha = 12$  deg.  $\xi_3 = +20$  deg.

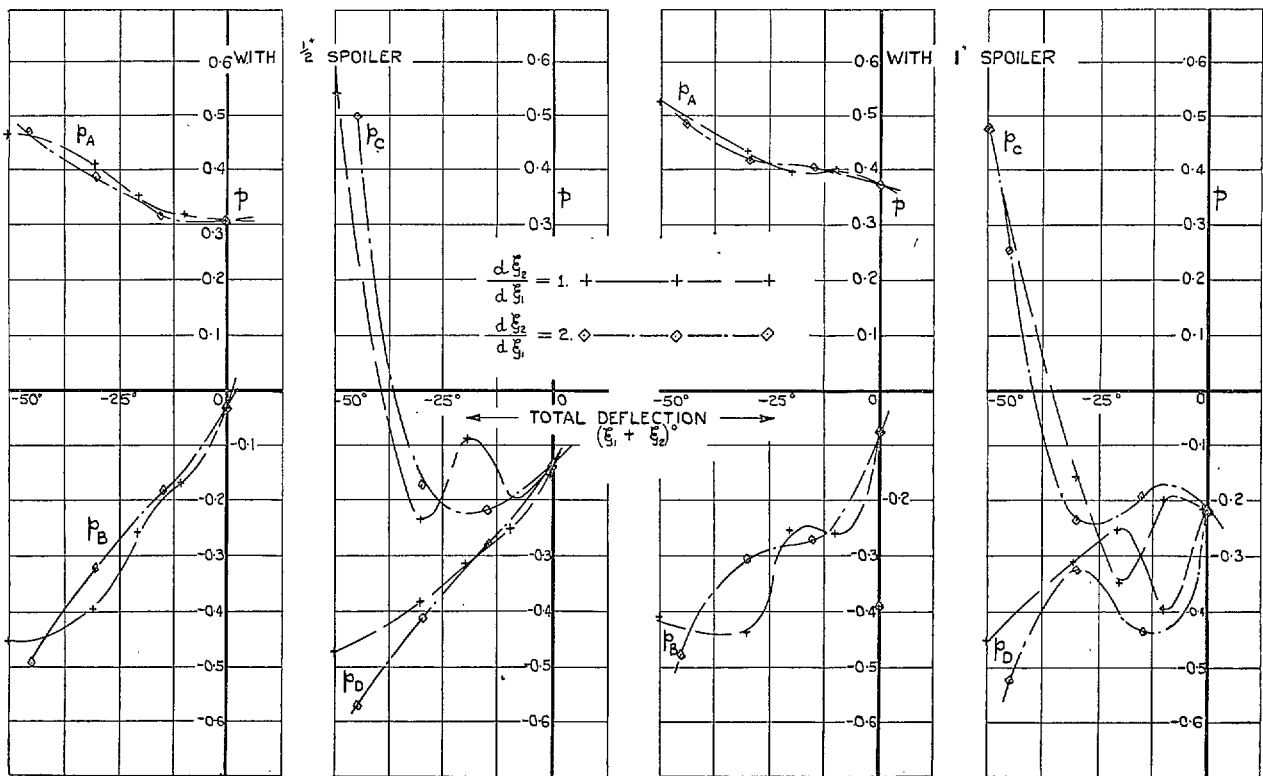

FIG. 19. Hinge pressures, with spoilers.  $\alpha = 0$  deg.  $\xi_3 = 0$  deg.

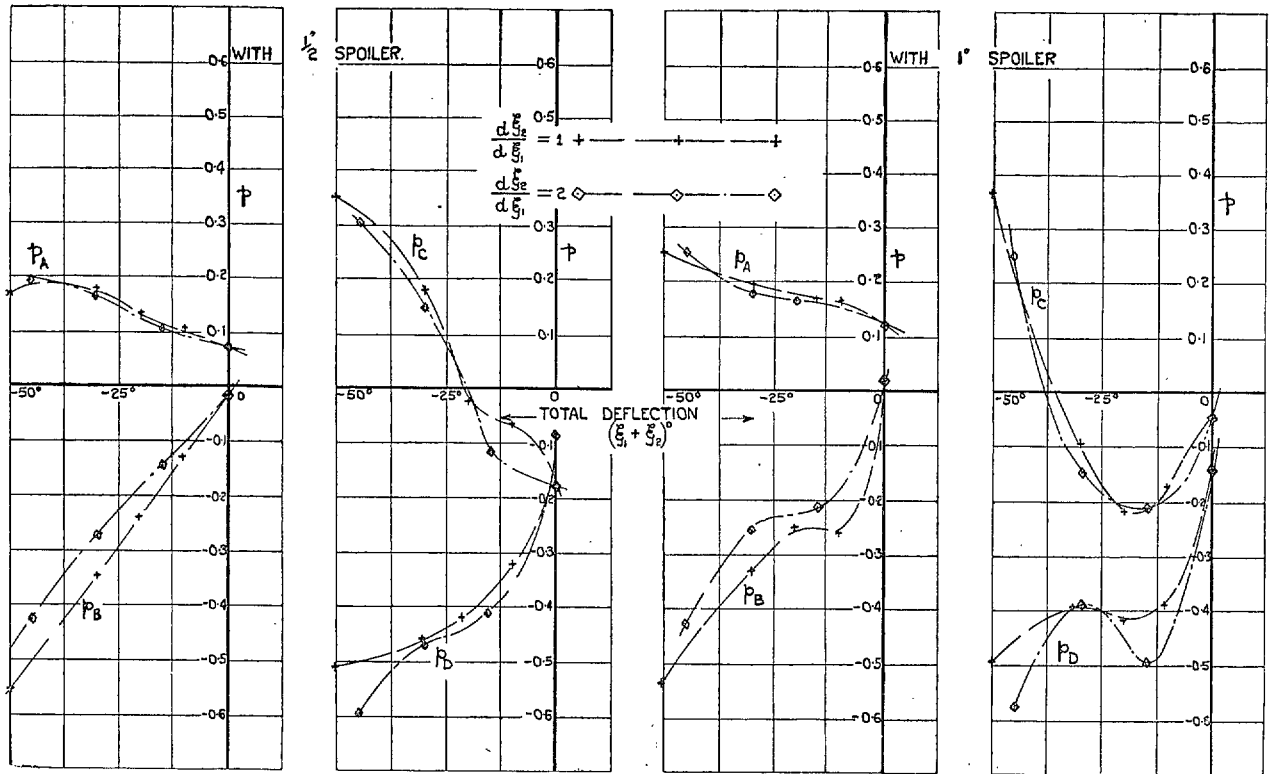
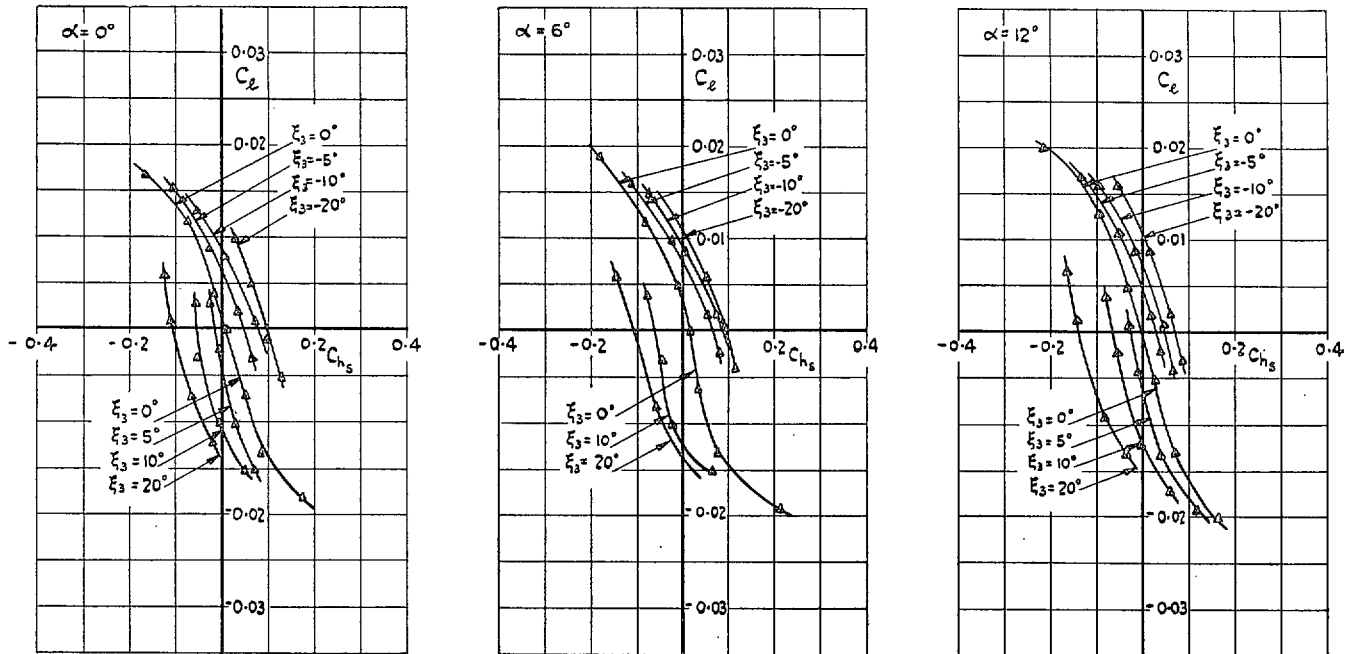

FIG. 20. Hinge pressures, with spoilers.  $\alpha = 12$  deg.  $\xi_3 = 0$  deg.



11 1/2% PRESSURE BALANCE.

FIG. 21. Rolling-moment coefficient versus stick-moment coefficient.  $d\xi_2/d\xi_1 = 0$ .

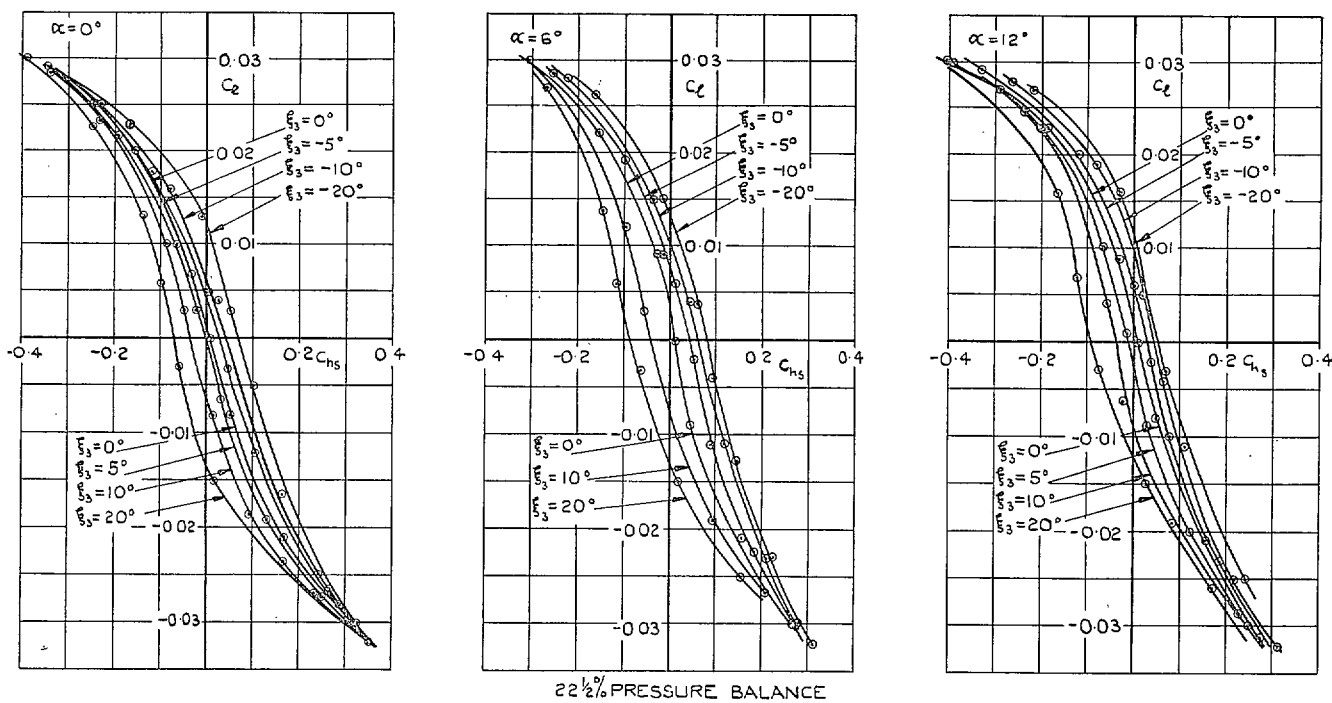

FIG. 22. Rolling-moment coefficient versus stick-moment coefficient.  $d\xi_2/d\xi_1 = 1$ .

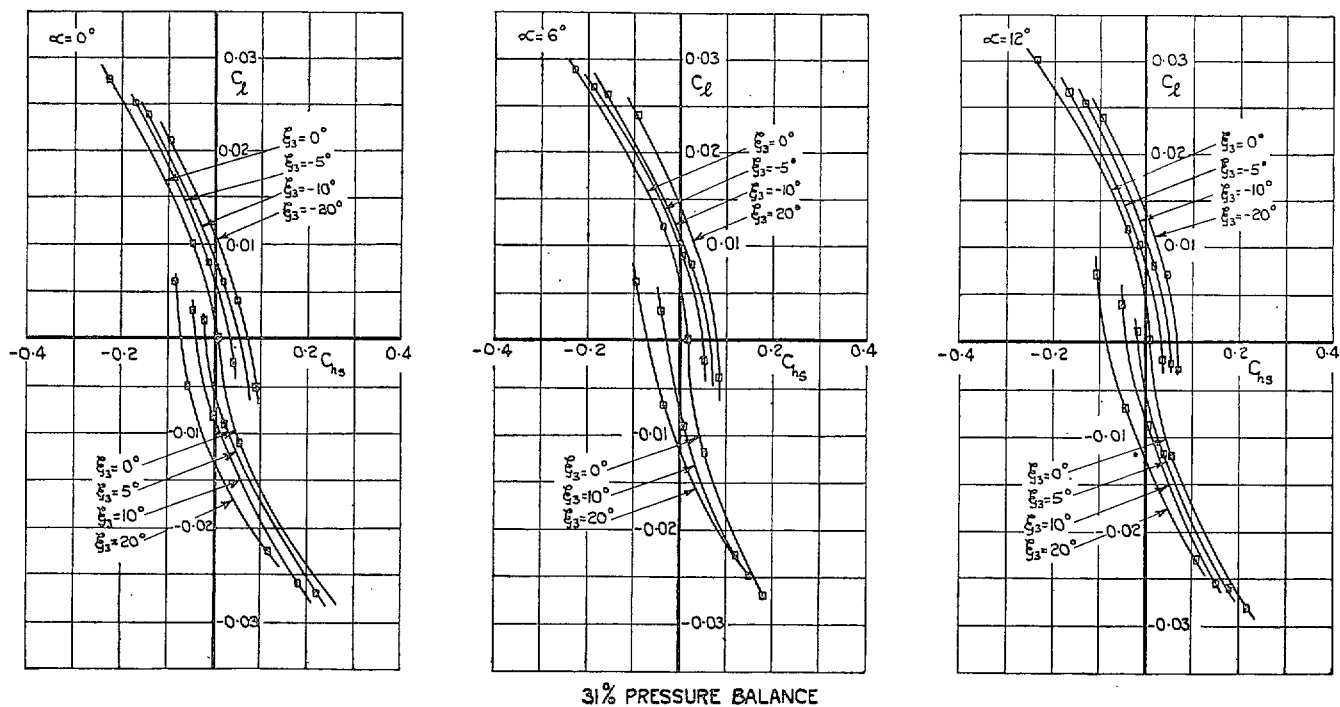
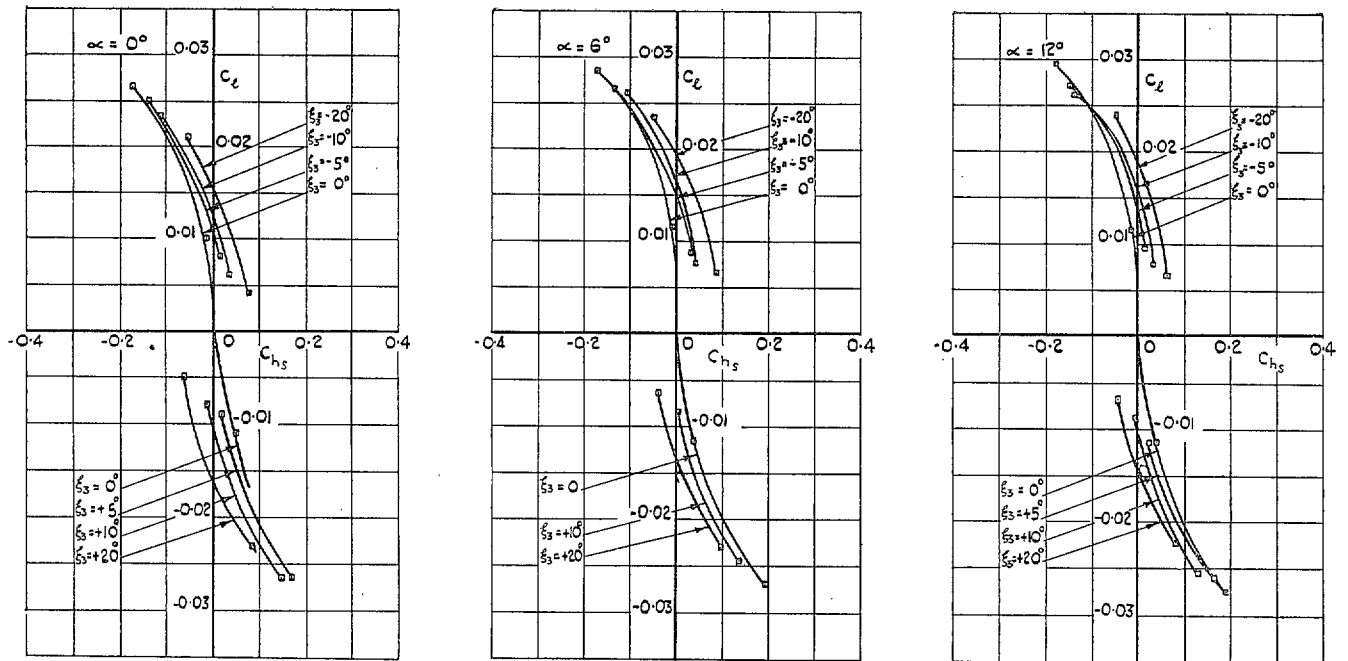
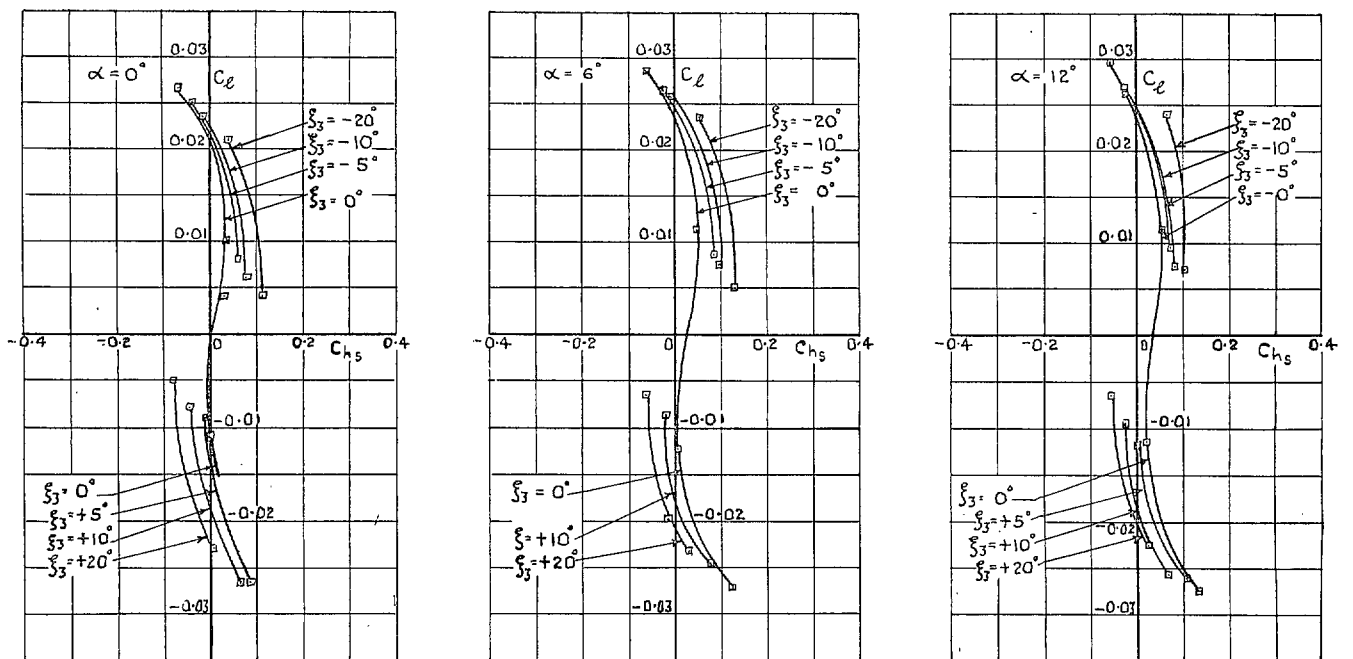

FIG. 23. Rolling-moment coefficient versus stick-moment coefficient.  $d\xi_2/d\xi_1 = 2$ .



40% PRESSURE BALANCE

FIG. 24. Rolling-moment coefficient versus stick-moment coefficient.  $d\xi_2/d\xi_1 = 2$ .



50% PRESSURE BALANCE.

FIG. 25. Rolling-moment coefficient versus stick-moment coefficient.  $d\xi_2/d\xi_1 = 2$ .

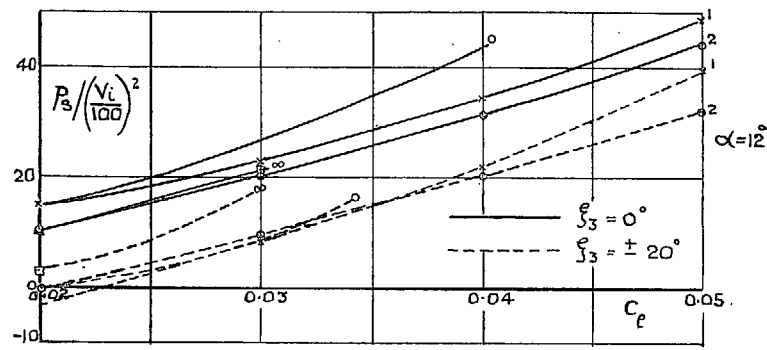
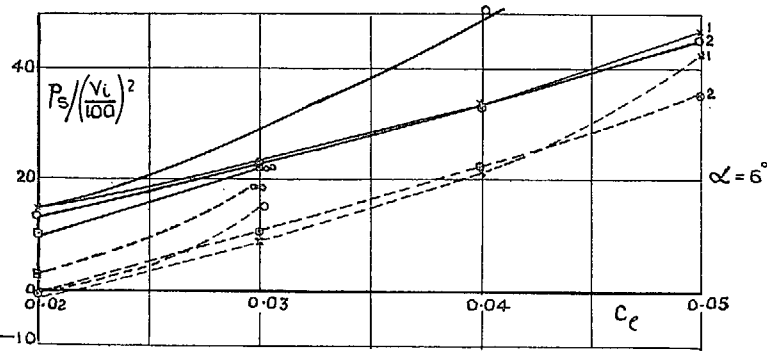
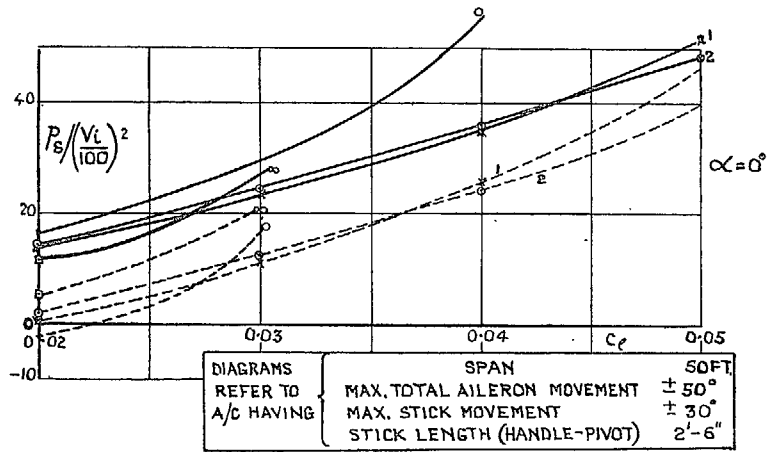

PLAIN DOUBLE AILERON WITH AND WITHOUT TAB AT  $\pm 20^\circ$

FIG. 26. Stick forces.

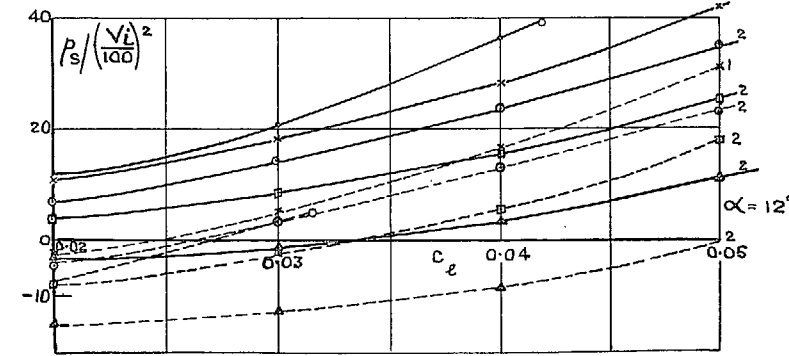
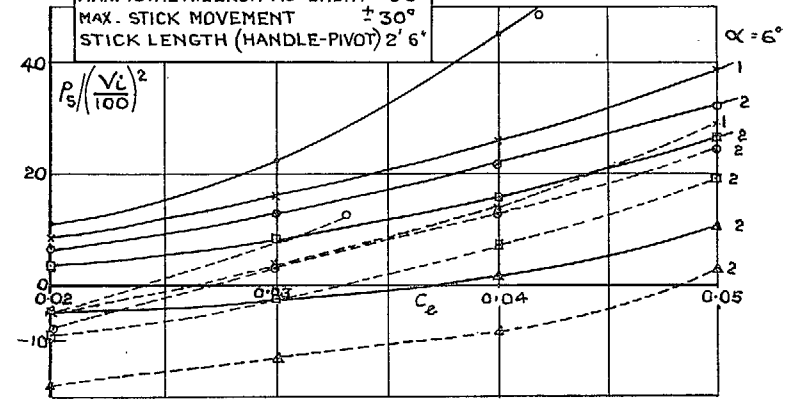
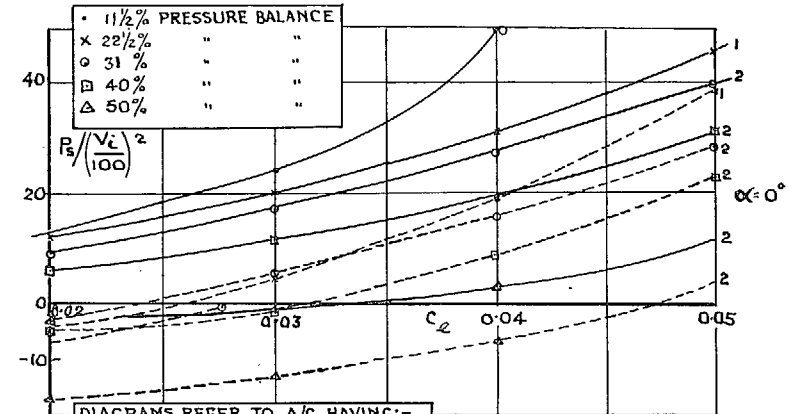
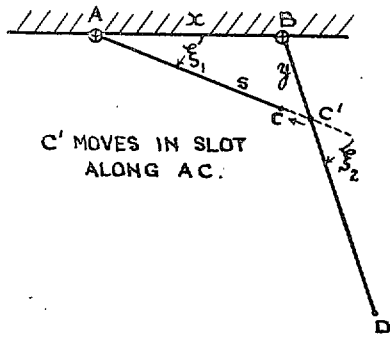
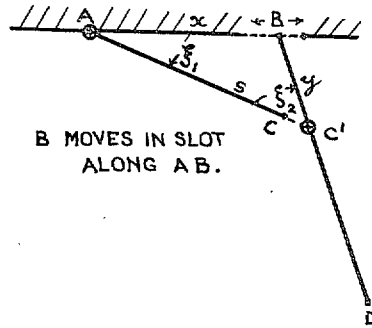

FIG. 27. Stick forces with pressure balance.





(a) SKELETON OF AMERICAN  
FLAP ARRANGEMENT.



(b) SKELETON OF ALTERNATIVE  
FLAP ARRANGEMENT.

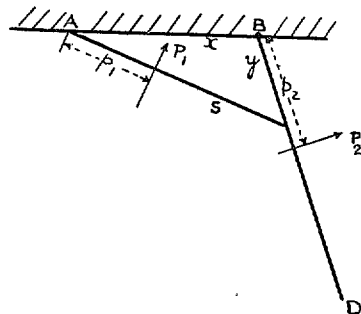

(c) ASSUMED SYSTEM OF AERODYNAMIC FORCES  
ACTING ON DOUBLE FLAP.

FIG. 28.

## Publications of the Aeronautical Research Council

### ANNUAL TECHNICAL REPORTS OF THE AERONAUTICAL RESEARCH COUNCIL (BOUND VOLUMES)—

- 1934-35 Vol. I. Aerodynamics. *Out of print.*  
Vol. II. Seaplanes, Structures, Engines, Materials, etc. 40s. (40s. 8d.)
- 1935-36 Vol. I. Aerodynamics. 30s. (30s. 7d.)  
Vol. II. Structures, Flutter, Engines, Seaplanes, etc. 30s. (30s. 7d.)
- 1936 Vol. I. Aerodynamics General, Performance, Airscrews, Flutter and Spinning.  
40s. (40s. 9d.)  
Vol. II. Stability and Control, Structures, Seaplanes, Engines, etc. 50s. (50s. 10d.)
- 1937 Vol. I. Aerodynamics General, Performance, Airscrews, Flutter and Spinning.  
40s. (40s. 10d.)  
Vol. II. Stability and Control, Structures, Seaplanes, Engines, etc. 60s. (61s.)
- 1938 Vol. I. Aerodynamics General, Performance, Airscrews. 50s. (51s.)  
Vol. II. Stability and Control, Flutter, Structures, Seaplanes, Wind Tunnels,  
Materials. 30s. (30s. 9d.)
- 1939 Vol. I. Aerodynamics General, Performance, Airscrews, Engines. 50s. (50s. 11d.)  
Vol. II. Stability and Control, Flutter and Vibration, Instruments, Structures,  
Seaplanes, etc. 63s. (64s. 2d.)
- 1940 Aero and Hydrodynamics, Aerofoils, Airscrews, Engines, Flutter, Icing, Stability  
and Control, Structures, and a miscellaneous section. 50s. (51s.)

*Certain other reports proper to the 1940 volume will subsequently be  
included in a separate volume.*

### ANNUAL REPORTS OF THE AERONAUTICAL RESEARCH COUNCIL—

1933-34	1s. 6d. (1s. 8d.)
1934-35	1s. 6d. (1s. 8d.)
April 1, 1935 to December 31, 1936.	4s. (4s. 4d.)
1937	2s. (2s. 2d.)
1938	1s. 6d. (1s. 8d.)
1939-48	3s. (3s. 2d.)

### INDEX TO ALL REPORTS AND MEMORANDA PUBLISHED IN THE ANNUAL TECHNICAL REPORTS, AND SEPARATELY—

April, 1950 R. & M. No. 2600. 2s. 6d. (2s. 7½d.)

### INDEXES TO THE TECHNICAL REPORTS OF THE AERONAUTICAL RESEARCH COUNCIL—

December 1, 1936 — June 30, 1939.	R. & M. No. 1850.	1s. 3d. (1s. 4½d.)
July 1, 1939 — June 30, 1945.	R. & M. No. 1950.	1s. (1s. 1½d.)
July 1, 1945 — June 30, 1946.	R. & M. No. 2050.	1s. (1s. 1½d.)
July 1, 1946 — December 31, 1946.	R. & M. No. 2150.	1s. 3d. (1s. 4½d.)
January 1, 1947 — June 30, 1947.	R. & M. No. 2250.	1s. 3d. (1s. 4½d.)

*Prices in brackets include postage.*

Obtainable from

### HER MAJESTY'S STATIONERY OFFICE

York House, Kingsway, LONDON, W.C.2    423 Oxford Street, LONDON, W.1  
P.O. Box 569, LONDON, S.E.1  
13a Castle Street, EDINBURGH, 2    1 St. Andrew's Crescent, CARDIFF  
39 King Street, MANCHESTER, 2    Tower Lane, BRISTOL, 1  
2 Edmund Street, BIRMINGHAM, 3    80 Chichester Street, BELFAST

or through any bookseller.