

ST. NO. R7405

U.D.C.

AUTH. *A*

R. & M. No. 2418
(9883 & 10,405)
A.R.C. Technical Report



MINISTRY OF SUPPLY
AERONAUTICAL RESEARCH COUNCIL
REPORTS AND MEMORANDA

The Effect of Tab Mass-balance on Flutter

PART I

Ternary Tailplane—Elevator—Tab Flutter

By

G. H. L. BUXTON, B.A., and G. D. SHARPE, B.A.,
of the Royal Aircraft Establishment.

PART II

Experiments on the Influence of Tab Mass-balance on Flutter

By

C. SCRUTON, B.Sc., P. M. RAY, B.A., and Miss D. V. DUNSDON,
of the Aerodynamics Division, N.P.L.

Crown Copyright Reserved

LONDON: HIS MAJESTY'S STATIONERY OFFICE

1951

PRICE 3s 6d NET



The Effect of Tab Mass-balance on Flutter

COMMUNICATED BY THE PRINCIPAL DIRECTOR OF SCIENTIFIC RESEARCH (AIR),
MINISTRY OF SUPPLY

Reports and Memoranda No. 2418

*November, 1946**

PART I

Ternary Tailplane—Elevator—Tab Flutter

By

G. H. L. BUXTON, B.A., and G. D. SHARPE, B.A.



Summary.—Following an accident to a Mosquito fitted experimentally by the Royal Aircraft Establishment with a g -restriction device involving heavy mass-overbalance of an elevator tab, an investigation has been made into the flutter characteristics of tailplanes carrying elevators and tabs. The degrees of freedom considered were vertical bending of the fuselage, elevator rotation and tab rotation. The tab was assumed to be spring-connected to the elevator, while the elevator was taken to be free. The effect of variation of the stiffness ratio, of the states of mass balance of the tab and elevator, and of horn balance of the elevator, was investigated. It was found that, with a statically balanced elevator and a statically overbalanced tab, ternary flutter could occur at low speeds while all binary motion involving two only of the degrees of freedom was stable at all speeds. Such flutter could be eliminated by a mass overbalance of the elevator. It is thought that similar results would apply to spring-tab systems, but this is to be investigated.

It is considered that flutter of this nature was a likely cause of the Mosquito accident, and it is recommended that in no circumstances should tabs be overbalanced unless a detailed investigation involving at least three degrees of freedom has shown the system to be flutter free.

1. *Introduction.*—In August, 1945, a Mosquito aircraft fitted experimentally by R.A.E. with a g -restrictor involving mass-overbalance of an elevator tab broke up in the course of diving and recovery trials at R.A.E. after violent fore-and-aft oscillation of the stick had been experienced by the pilot. Subsequent examination of the wreckage showed that violent oscillation of both elevator and tab had occurred. An enquiry into the flutter characteristics of elevator-tab systems, with particular reference to mass-overbalance, was therefore demanded.

The system of g -restriction employed is shown in Fig. 1. It consists of a heavily mass-overbalanced tab (about 100 per cent. over static balance) hinged to the elevator and connected to it by means of a preloaded spring. Motion of the balance weight in the upward direction is prevented by means of a stop. Any excessive acceleration of the aircraft in the upward direction (perpendicular to the direction of flight) deflects the balance weight and tab against the preload, resulting in a deflection of the elevator which induces an acceleration of the aircraft in the opposite sense.

* R.A.E. Report No. S.M.E. 3390 received 6th March, 1947 (Part I). A.R.C. Report No. 9883, 13th August, 1946 (Part II).

The tailplane, elevator and tab used in this investigation are rectangular surfaces having the same span and mean chord as those of the standard Mosquito. The inertias, however, are not those of the Mosquito and its *g*-restrictor tab, since no accurate data were at first available, but may be regarded as those of a typical aircraft of the light bomber class. The tab was assumed to be spring connected to the elevator without preload and to oscillate about its equilibrium position. Consequently, although the results probably apply qualitatively to the Mosquito case, no quantitative agreement of critical speeds and frequencies is to be expected.

It was found that ternary flutter of such a system could occur at low speeds for a 100 per cent. mass-overbalanced tab and a statically balanced elevator. This flutter was characterised by the fact that all binary motion resulting from combinations of the degrees of freedom in pairs was stable at all speeds. These facts had not been previously known to English workers on flutter problems, but German literature which subsequently became available showed that the Germans had been aware of this phenomenon since early 1940, when Voigt and Walter¹ published the results of wind-tunnel experiments on the flutter of a two-dimensional wing-aileron-tab model carried out at the D.V.L. Later these results were verified by an extensive series of calculations made by H. Wittmeyer², in which the influence of the structural parameters of the tab was systematically investigated. Following these investigations the Germans recommended that all tabs should be statically balanced.

In the present report the influence of elevator mass-balance, as well as that of tab mass-balance, is investigated, and it is shown that flutter caused by mass overbalance of a tab may be eliminated by mass overbalance of the elevator. This fact does not appear to have been noticed by the Germans.

The results of the present investigation have been checked by a series of wind-tunnel tests on a three-dimensional wing-aileron-tab model, carried out at the National Physical Laboratory by Scruton, Ray, and Dunsdon. These are reported in Part II and are in qualitative agreement with the results given in this part of the work.

2. Range of Investigation.—The plan form and dimensions of the tailplane considered are shown in Fig. 2. The following three degrees of freedom were taken into account :

- (1) vertical translation of the tailplane, representing approximately the effect of fuselage bending and aircraft pitching with a node well ahead of the tailplane leading edge,
- (2) rigid rotation of the elevator,
- (3) rigid rotation of the tab.

The freedom (1) was assumed to be constrained by a spring, representing the stiffness of the fuselage in vertical bending. The tab was assumed to be spring connected to the elevator, the elevator being taken to be free.

The influence on flutter of the following factors was investigated :

- (1) mass-balance of the elevator,
- (2) mass-balance of the tab,
- (3) the ratio of the fuselage bending stiffness to the stiffness of the spring connection between the tab and the elevator,
- (4) aerodynamic horn-balance of the elevator.

The effect of the stiffness ratio on the flutter speed for a statically balanced elevator and a tab 100 per cent. overbalanced was first investigated. This corresponded approximately to the balance conditions on the Mosquito at the time of the accident. Curves were drawn for an elevator one-third and two-thirds horn-balanced ; the former closely approximated to the aerodynamic balance on the Mosquito elevator⁶. Comparison of the two curves suggested that horn balance had no important influence on the flutter characteristics, the larger horn-balance resulting only in a small increase in the critical speed. Further calculation was therefore confined to the case of no horn balance. Comparison with the results for no horn-balance confirmed this conclusion.

Curves were then drawn showing the variation of the critical speed with tab balance for a typical value of the stiffness ratio and various values of the elevator mass-balance. For this purpose mass was added to the tab on an arm of definite length, so that both the tab product of inertia and moment of inertia varied. The state of balance of the elevator, and its moment of inertia, also varied slightly with the tab mass-balance, but the elevator balance weights were chosen to correspond to the following states of balance of the elevator with a 100 per cent. over-balanced tab :

- (a) statically balanced elevator,
- (b) elevator 100 per cent. overbalanced,
- (c) elevator 50 per cent. balanced.
- (d) unbalanced elevator.

A curve was also obtained showing the variation of the critical speed with elevator balance for a 100 per cent. overbalanced tab.

Finally curves of flutter speed against tab mass-balance for case (a) were obtained for a number of other values of the stiffness ratio.

3. *Aerodynamic Assumptions.*—The aerodynamic forces on the system as a whole were calculated by strip theory, using constant derivatives appropriate to two-dimensional incompressible flow at a fixed value of the frequency parameter ($\lambda \equiv \omega c/V = 1$, where c is the mean chord of the tailplane). This device simplified the mathematical computation considerably. The derivatives were not given their full theoretical values but were reduced by various factors which experience has indicated to be advisable (see Jahn and Boss^{4,5}) to allow for the discrepancies between theory and experiment, and also to allow very roughly for the effect of slight aerodynamic balance of the control surfaces due to a set-back of the hinge.

To allow for the effect of the horn-balance the forces on the horn were calculated by strip theory, using two-dimensional derivatives appropriate to the case of a wing without flap. The proportion ξ of the span of the elevator which must be horn-balanced in order to balance the surface statically was then calculated. Flutter calculations were made for values of ξ one-third and two-thirds of this value, the former corresponding approximately to the state of balance on the Mosquito elevator⁶.

4. *Presentation of the Results.*—The critical speed was plotted in the form of a non-dimensional parameter based on one or other of the two stiffnesses. In Fig. 3 the abscissa is the stiffness ratio (multiplied by a convenient power of 10). In Figs. 4, 6, 7, 8 and 10 the critical-speed parameter is plotted against the tab mass-balance parameter μ . μ is the ratio of the static moment due to the tab mass-balance weight (positive for positive masses) to the mass moment of the unbalanced tab ; thus $\mu = 0$ represents the unbalanced tab, $\mu = 1$ a statically balanced tab, $\mu = 2$ a tab with " twice static " balance (i.e. a tab 100 per cent. statically overbalanced) etc. χ (Fig. 9) is a similar function of elevator balance. Negative values of μ and χ have no practical significance for the particular tailplane considered, since they correspond to the addition of a negative balancing mass ; they may however be regarded as representing the addition of a mass behind the hinge, provided at the same time the moment of inertia of the flap is diminished. The system thus represents a physically possible one so long as the flap moment of inertia remains positive. The points $\mu = -0.796$ and $\chi = -1.186$ at which the tab and elevator moments of inertia vanish are shown on the graphs ; for values of μ and χ less than this the system no longer represent a practical case. Points corresponding to negative values of μ and χ are shown, partly because of the considerations mentioned above, and partly because the inverse method of solution adopted enabled points corresponding to negative values of μ and χ to be obtained at the same time as positive ones.

5. *Discussion of the Results.*—5.1. *Existence of Ternary Flutter with a Mass Overbalanced Tab.*—Fig. 3 shows that ternary flutter was possible for the balance conditions existing on the Mosquito at the time of the accident, viz., static balance of the elevator combined with 100 per cent. static overbalance of the tab, for all ratios of the stiffness h_β of the spring connection between the tab and the elevator to the tailplane stiffness l_ϕ . From this figure it can be seen that, since the flutter-speed parameter based on l_ϕ has a finite value when $r \equiv 10^4 h_\beta/l_\phi = 0$, the critical speed tends to infinity when l_ϕ tends to infinity for a constant value of h_β , so that the elevator-tab binary motion is stable. At the other end of the curve, it may be shown that the critical speed tends to infinity as h_β tends to infinity for a constant value of l_ϕ , so that the elevator-tailplane binary is also stable. Finally a binary oscillation involving the tailplane and tab only can be shown to be stable for all values of the stiffness ratio. Thus all three constituent binaries of the ternary motion are stable, while the ternary motion itself is unstable.

The occurrence of flutter of this type, in the case of mass-overbalanced tab systems, has been verified experimentally by a series of tunnel tests on a model wing with aileron and tab, carried out at the N.P.L. by Scruton, Ray and Dunsdon. These are discussed in section 7 and reported in Part II.

5.2. *Effect of the Horn-Balance.*—From Fig. 3 it will be seen that the horn balance has no important effect on the flutter characteristics, but that with a horn giving one-third aerodynamic balance the critical speed is raised by about 15–20 per cent. over that with no horn-balance. A larger amount of horn-balance gives a corresponding increase.

5.3. *Effect of the Stiffness Ratio.*—Fig. 3 shows that for the balance conditions considered ($\mu = 2$, $\chi = 1$) the flutter speed increases with increasing h_β , i.e. with increasing stiffness of the connection between tab and elevator. An examination of the diagram will reveal, however, that if the stiffness ratio is increased by decreasing the fuselage stiffness l_ϕ , keeping the tab-spring stiffness constant, the flutter speed will decrease. In other words, increase of the fuselage stiffness is also beneficial. This fact is shown more clearly in Fig. 10 (discussed below) where the flutter speed parameter is based on h_β .

5.4. *General Effect of Tab and Elevator Mass-balance on Flutter.*—Fig. 4 shows the flutter speed plotted against the mass balance parameter μ of the tab for an elevator which is statically balanced at the condition $\mu = 2$. The curve consists of two branches which correspond roughly to underbalance and overbalance of the tab respectively. Between them they cover practically the whole range of values of μ , there being only a small range of μ near the mass-balanced condition ($\mu = 1$) where the system is flutter free. Thus for the overbalanced condition represented by $\mu = 2$ the system is well within the flutter region.

Calculations of amplitude ratios and phase differences at a number of points on the curve suggest that the amplitude ratios and phase differences do not vary much over the overbalanced portion of the curve, but vary considerably over the underbalanced portion. Vector diagrams showing the amplitude ratios and phase differences at four points of the curve are shown in Fig. 5. It may be noted that the phase angle between the elevator and the tab remains practically constant at 40 deg.–60 deg. and also that the tab and tailplane amplitudes decrease relative to that of the elevator as the tab-balance weight increases. There does not appear to be any marked change in the flutter mode as one passes from one branch of the curve to the other.

Figs. 6–8 show the critical speed as a function of tab balance for a number of other elevator balance conditions. Fig. 6 shows the effect of a 100 per cent. overbalance of the elevator ($\chi = 2$ for $\mu = 2$). It will be seen that the underbalanced portion of the curve is hardly affected by the change of elevator balance, but the overbalanced portion is shifted bodily away from the underbalanced portion, so that a larger flutter-free region exists. The curve is also raised slightly so that the critical speeds given by the overbalanced portion of the curve are somewhat higher. There is no flutter now for $\mu = 2$, i.e. flutter caused by overbalance of the tab has been eliminated by an overbalance of the elevator.

As the elevator balance weight is reduced the overbalanced portion of the curve moves in the opposite direction, i.e. towards the underbalanced portion, and for a sufficiently small value of the balance weight coalesces with it. This is the case in Fig. 7 (50 per cent. balanced elevator, $\chi = \frac{1}{2}$) where the curve consists of one branch covering the whole range of values of μ . For smaller values of the elevator balance (Fig. 8, unbalanced elevator, $\chi = 0$), flutter still exists for all values of μ , and further branches of the curve begin to appear in the overbalanced range.

The effect of increased elevator balance in eliminating flutter of an overbalanced tab is shown also in Fig. 9, where the flutter-speed parameter is plotted against the elevator-balance parameter χ for a 100 per cent. overbalanced tab ($\mu = 2$). Flutter disappears for an elevator overbalance of approximately 85 per cent. ($\chi = 1.85$). The elevator-tailplane binary is plotted on the same diagram, and also three points of the ternary curve for a statically balanced tab; the latter were obtained by cross-plotting from Figs. 4, 7 and 8. The figure shows that there is fairly close agreement between the elevator-tailplane binary and the ternary for a statically-balanced tab; the former indicates freedom from flutter for an elevator balance of approximately 85 per cent. ($\chi = 0.85$). The effect of an overbalance of the tab is to shift the ternary curve in the direction of increasing χ , so that a greater degree of elevator balance is required in order to eliminate flutter. Mass-overbalance of the tab thus has a similar effect to that of the addition of mass to the elevator aft of the hinge line.

5.5. Effect of the Stiffness Ratio on the Variation of the Flutter Speed with Tab Mass-balance— In Fig. 10 the critical-speed parameter for a statically-balanced elevator ($\chi = 1$ for $\mu = 2$) is plotted against the tab mass-balance parameter for a number of stiffness ratios. The critical speed parameter is here based on h_β instead of l_ϕ in order that the elevator-tab binary flutter speed may be plotted. The stiffness ratio is seen to have a considerable effect on the separation of the two branches of the curve. The following conclusions may be drawn from these curves.

(1) An increase in the stiffness ratio h_β/l_ϕ tends to shift the overbalanced portion of the curve away from the underbalanced portion and so create a larger flutter-free gap.

(2) If the stiffness ratio h_β/l_ϕ is decreased the two portions of the curve approach one another and ultimately coalesce.

(3) Along the overbalanced portion of the curve the flutter speed increases with increasing fuselage stiffness if the tab stiffness is kept constant.

(4) Along the underbalanced portion of the curve the flutter speed may decrease with increasing fuselage stiffness for a given tab stiffness.

(5) Along most of the overbalanced portion of the curve all three constituent binaries of the ternary system are stable.

(6) Even over the underbalanced portion of the curve no reliable indication of the flutter characteristics of the system can be obtained by considering only binary flutter speeds. The tailplane-elevator and tailplane-tab binaries are stable over the whole range of μ plotted, while the ternary flutter speed is in general very much lower than that given by the elevator-tab binary.

6. Order of Magnitude of the Flutter Speeds.—As has been mentioned in the introduction, no quantitative agreement of flutter speeds and frequencies with the speed and frequency observed at the time of the Mosquito accident is to be expected from this investigation. It may be remarked however that the system considered here is almost certainly less favourable from the flutter viewpoint than the system existing on the Mosquito, since the tab inertia is greater and the elevator inertia less than for that system^{2,7}. Bearing these remarks in mind, we may proceed to evaluate the flutter speed and frequency for the balance and approximate stiffness conditions obtaining on the Mosquito, using the results of this report.

Taking $l_\phi = 100,000$ lb. ft./radian,
 $h_\beta = 20$ lb. ft./radian (giving $r = 2$),
 $\mu = 2$
 $\chi = 1$
 $\xi = 0.0153$ (i.e. elevator one-third horn-balanced),

we find from Figs. 3 and 4

$$V_c = 0.55 \sqrt{\frac{100,000}{0.002378 \times 8 \times (4.5)^2}} \times \frac{15}{22}$$

$$= 143 \text{ m.p.h. A.S.I.}$$

$$f_c = 0.232 \sqrt{\frac{100,000}{0.002378 \times 8 \times (4.5)^2}} \times \frac{1}{2\pi \times 4.5}$$

$$= 3.1 \text{ c.p.s.}$$

The figure of 3.1 c.p.s. agrees well with the pilot's estimate of frequency as between 2 and 3 c.p.s., but the flutter speed of 143 m.p.h. is, as expected, considerably less than the speed of 370 m.p.h. A.S.I. at which the oscillations were first observed. It may be remarked, however, that the speed of 370 m.p.h. is not necessarily the flutter speed of the Mosquito system, but is the speed, probably somewhat above the flutter speed, at which g was first applied in the recovery manoeuvre in question. Flutter of the type considered here may have been possible at lower speeds, but could not begin before the application of g , since downward movement of the tab was prevented by means of the balance weight stop.

7. Comparison with Other Work.—The phenomenon of the flutter of mass-overbalanced tabs was first observed by Voigt and Walter¹ in experiments on a two-dimensional wing-aileron-tab model in the medium-size wind tunnel of the D.V.L. These results were subsequently confirmed theoretically by extensive calculations undertaken by the Focke-Wulf Company under the direction of H. Wittmeyer². Both Voigt and Walter, and Wittmeyer plot the critical-speed parameter as a function of the centre-of-gravity position of the tab for constant values of the tab and aileron moment of inertia; in our results the tab and elevator moments of inertia are allowed to vary with the state of tab balance, so that no direct comparison is possible with their curves. A cross-plot of their results, however, shows a similar variation of the critical speed with tab mass balance to that found by us, the curve consisting frequently of two branches covering the underbalanced and overbalanced ranges of the tab centre of gravity, sometimes of one branch extending over the complete range. Their curves also show a similar effect due to a change of stiffness ratio for a free main control. The influence of the degree of mass-balance of the main control was not investigated by Wittmeyer.

In Part II of this report Scruton, Ray and Dunsdon describe experiments made at the N.P.L. on the flutter of a three-dimensional wing model with a part span aileron and tab, the degrees of freedom allowed being wing rolling (or flexure in a linear mode), aileron rotation and tab rotation. The influence of tab and aileron balance is investigated, and though the inertial constants differ considerably from ours the results agree qualitatively with those given here. In particular flutter was found to occur for a mass-overbalanced tab and a statically-balanced aileron. This flutter was of an essentially ternary type and could be stopped by locking any one of the three degrees of freedom.

Their results differ from ours in one respect, in that no flutter was found to occur with an unbalanced tab. A series of experiments in which mass was added in stages to the tab trailing edge showed, however, that flutter could be produced by sufficiently increasing the moment of inertia and out-of-balance moment of the tab. It thus appears likely that, by constructing a tab with sufficiently small inertia, flutter could be avoided without mass-balance of the tab; this possibility is in accordance with the conclusions of Collar and Sharpe^{7,8} with regard to spring tabs.

Since the effect of tab overbalance is to require a greater degree of elevator balance for the elimination of flutter, it is possible that underbalance of such a tab might have a reverse effect, i.e. the underbalanced tab might act as a partial balance to the elevator, and so result in a reduction of the elevator balance weight required for the elimination of flutter. This possibility is to be explored in a future programme of calculation.*

8. *Relation of the Results to Spring-tab Flutter.*—In spring-tab systems there is a mechanical linkage between the tab and the control surface which, when the elasticity of the control circuit is called into play, gives rise to an elastic coupling between the tab motion and the motion of the main control. Thus there is a considerable difference between such a system and the one considered here. If, however, the stick is free and the control circuit is regarded as rigid (this means in the case of ailerons that the motion is anti-symmetrical), the elastic cross-stiffness disappears and the system becomes analogous to the simple case considered here. The conclusions given in the next section are therefore applicable to such systems, and it is reasonable to suppose that similar results will apply to spring-tab systems in general. Some work on the ternary flutter of spring-tab systems is being done to supplement the work of Collar and Sharpe^{7,8} on binary flutter, and a report on this will be issued in due course.

9. *Conclusions and Recommendations.*—From the work described here it may be concluded that:—

- (a) flutter of the tail unit due to the combination of a mass-overbalanced tab with a statically-balanced elevator was the probable cause of an accident to a Mosquito fitted with a *g*-restrictor tab,
- (b) flutter is in general likely with control systems involving mass overbalance of tabs moving independently of the main control, unless the main control is also mass overbalanced. If such flutter occurs, increased mass-balance of the main control will have a beneficial effect on the flutter and may eliminate it altogether,
- (c) the occurrence of flutter of this type cannot be predicted by considering binary combinations of freedoms only. Even when the tab is underbalanced, binary calculations do not give a reliable indication of the flutter characteristics of a tab system.

On the basis of these results the following design recommendations may be made.

- (a) Mass overbalance, above the value required for static balance, of tabs moving independently of the main control, should be avoided, unless a detailed investigation has shown the system to be flutter free. Any such investigation must take into account at least the three degrees of freedom,
 - (i) vertical translation or flexure of the main lifting surface,
 - (ii) rotation of the main control,
 - (iii) rotation of the tab.
- (b) Slight mass overbalance of the main control is beneficial.
- (c) With a main control which is just statically balanced, the centre of gravity of the tab should lie approximately on the tab hinge line.

* This suggestion is due to E. G. Broadbent.

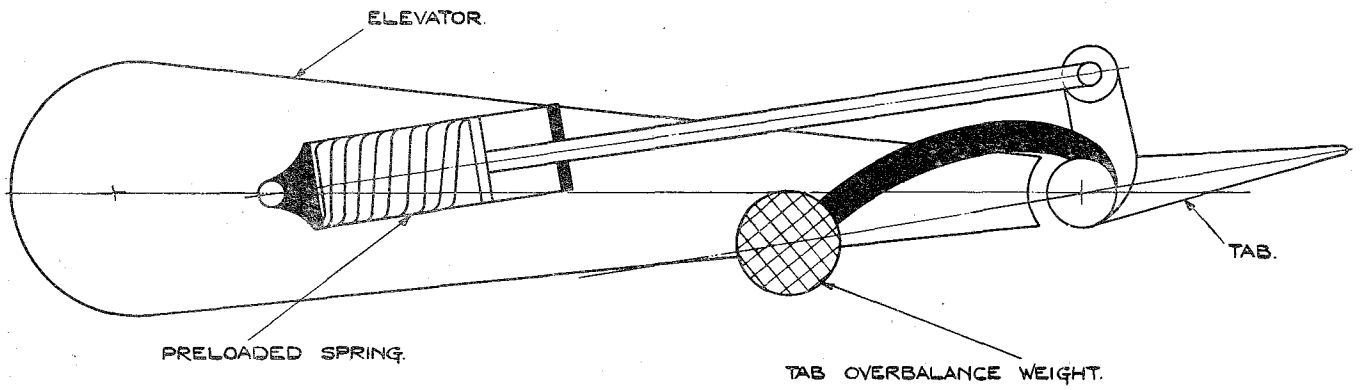

FIG. 1. Sketch of the g-restrictor System.

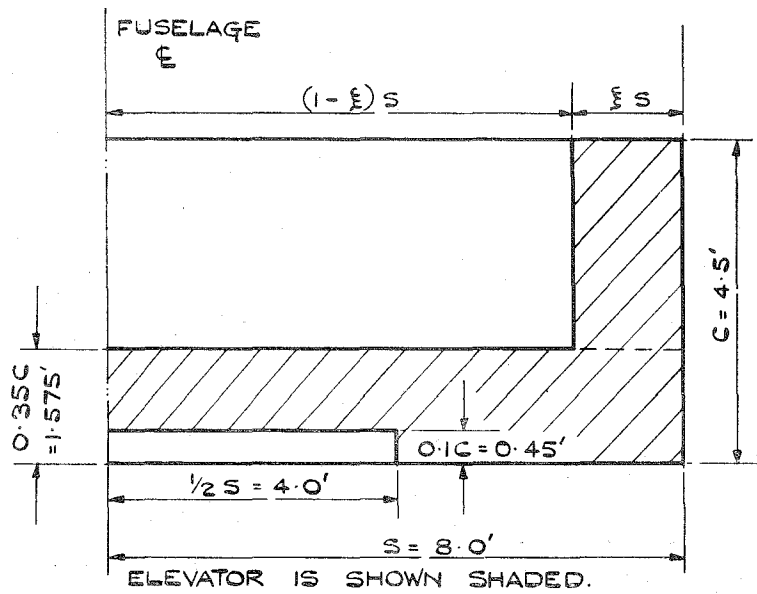

FIG. 2. Plan View and Dimensions of the Tailplane Used in the Investigations.

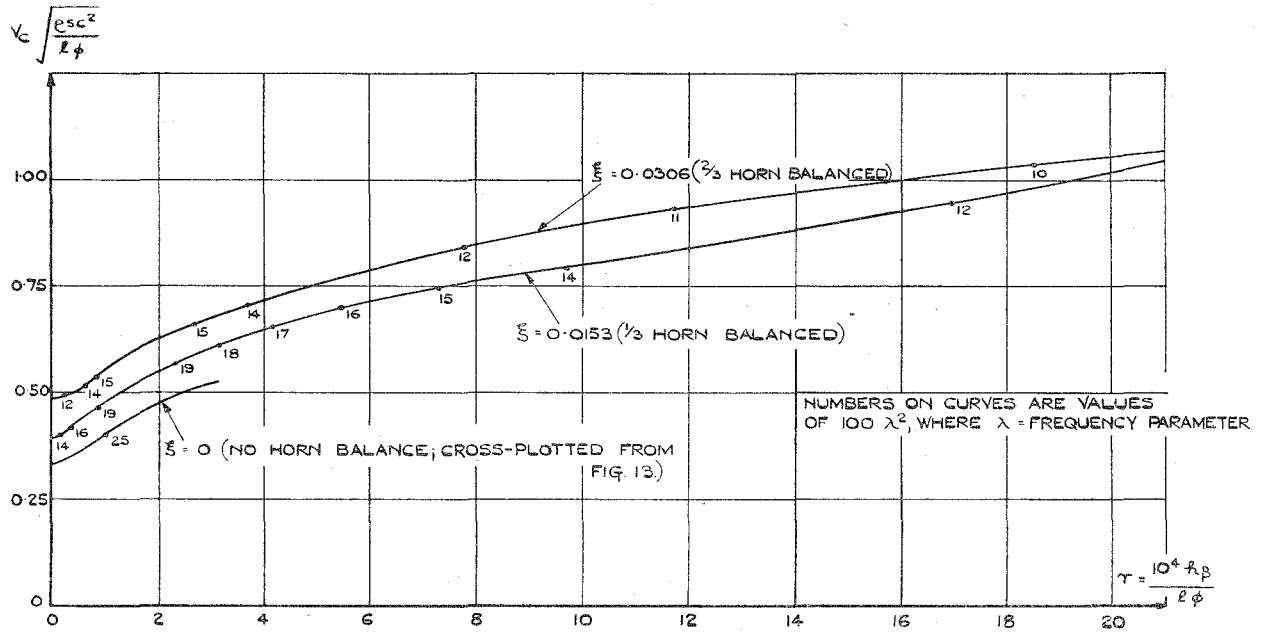

FIG. 3. Variation of Flutter-speed Parameter with Stiffness Ratio—for Statically Mass-balanced Elevator and 100 per cent. Mass-overbalanced Tab and Three Values of the Aerodynamic Elevator Horn-balance.

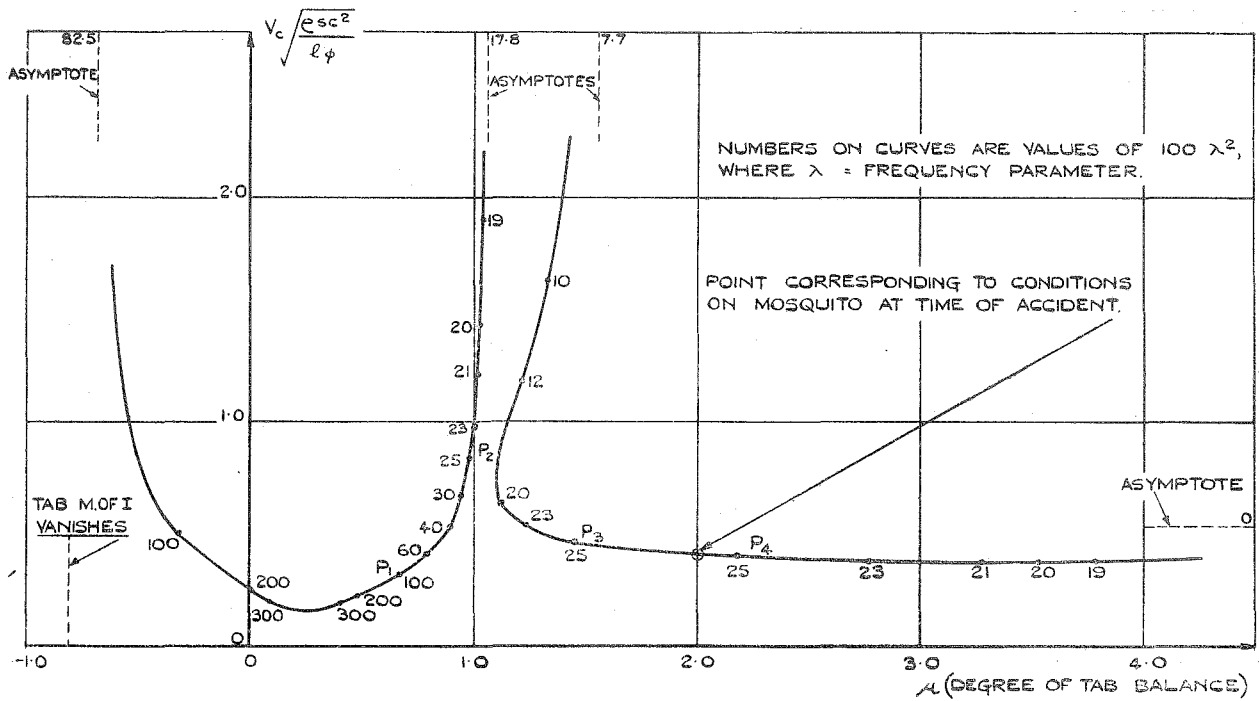

FIG. 4. Variation of Flutter Speed with Tab Mass-balance for Statically-balanced Elevator.

($r = 1$; $z = 1$ for $\mu = 2$).

$\mu = 0$ corresponds to no balance weight on the tab.

$\mu = 1$ corresponds to static balance of the tab.

Tab balance weight $m = 1.17\mu$ lbs.

Elevator balance weight $M = 12.5$ lbs.

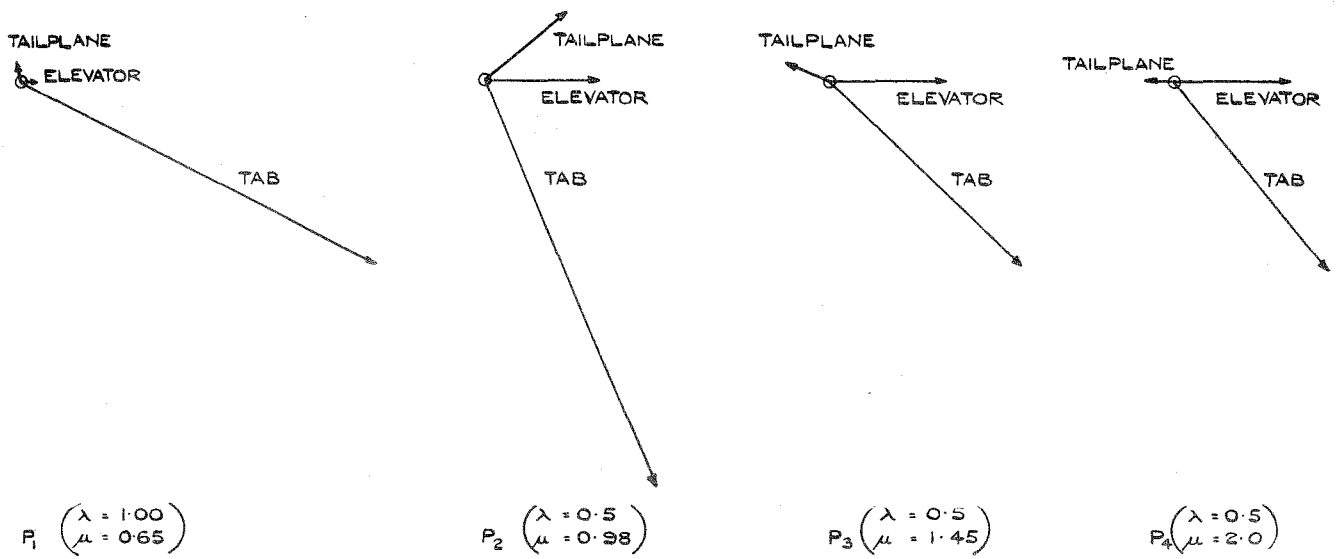

FIG. 5. Vector Diagrams Showing the Phase Differences and Relative Amplitudes of the Motion at the Four Points "P" of Fig. 4.

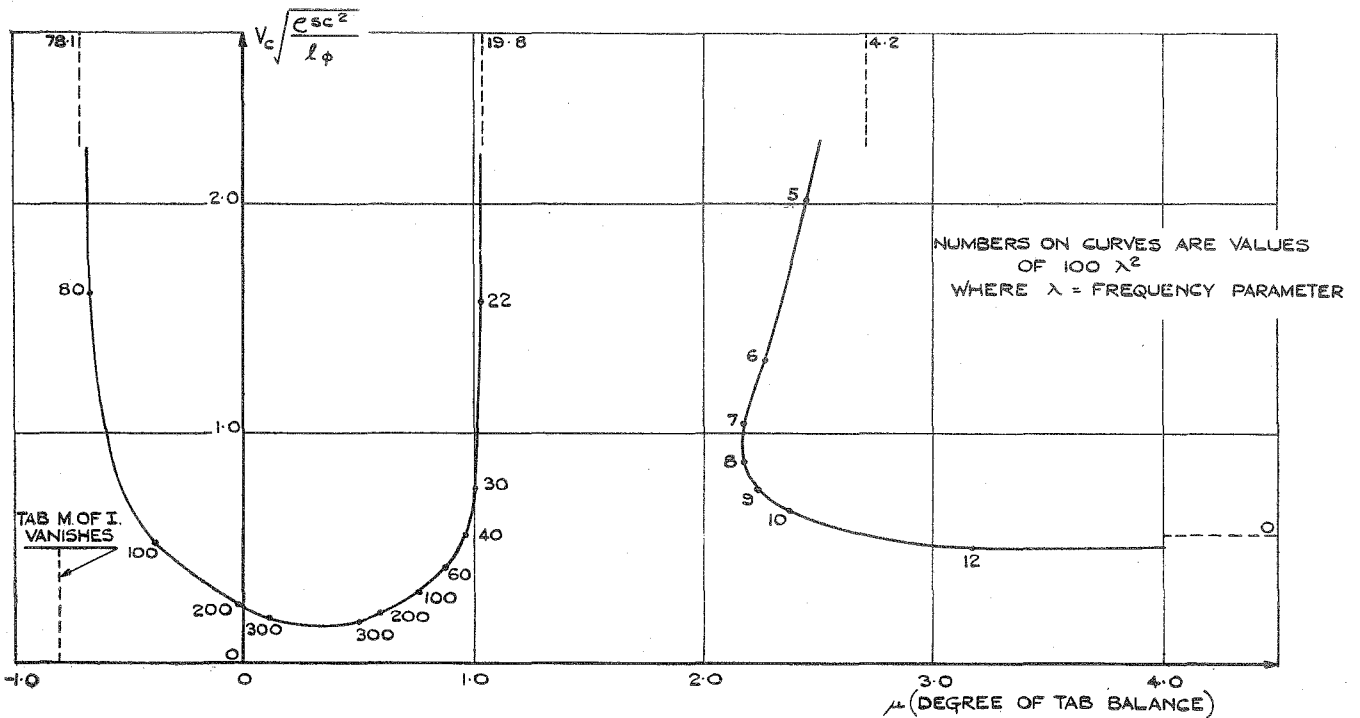

FIG. 6. Variation of Flutter Speed with Tab Mass-balance for Elevator with Twice Static Balance.

$$(\gamma = 1; \chi = 2 \text{ for } \mu = 2)$$

$\mu = 0$ corresponds to no balance weight on the tab.
 $\mu = 1$ corresponds to static balance of the tab.

Tab balance weight $m = 1.17\mu$ lb.
 Elevator balance weight $M = 25$ lb.

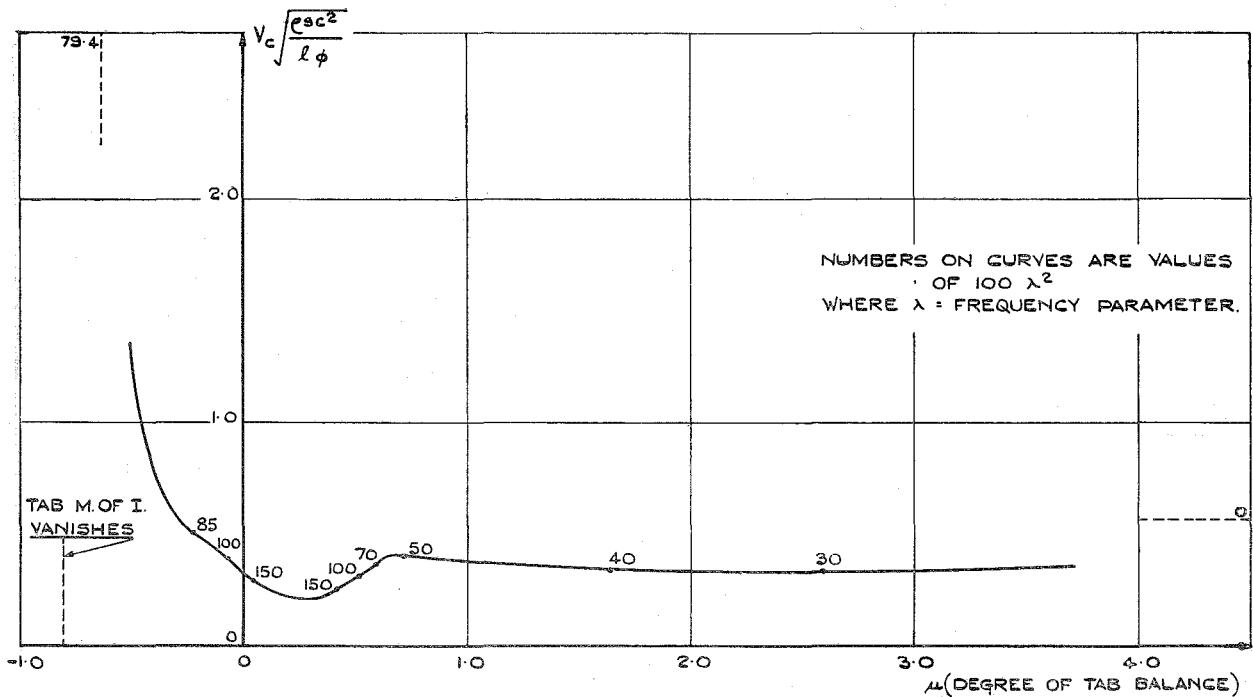

FIG. 7. Variation of Flutter Speed with Tab Mass-balance for Elevator with 50 per cent. Static Balance.]

$(r = 1; \chi = \frac{1}{2} \text{ for } \mu = 2)$

$\mu = 0$ corresponds to no balance weight on the tab.

Tab balance weight $m = 1.17\mu$ lb.

$\mu = 1$ corresponds to static balance of the tab.

Elevator balance weight $M = 6.25$ lb.

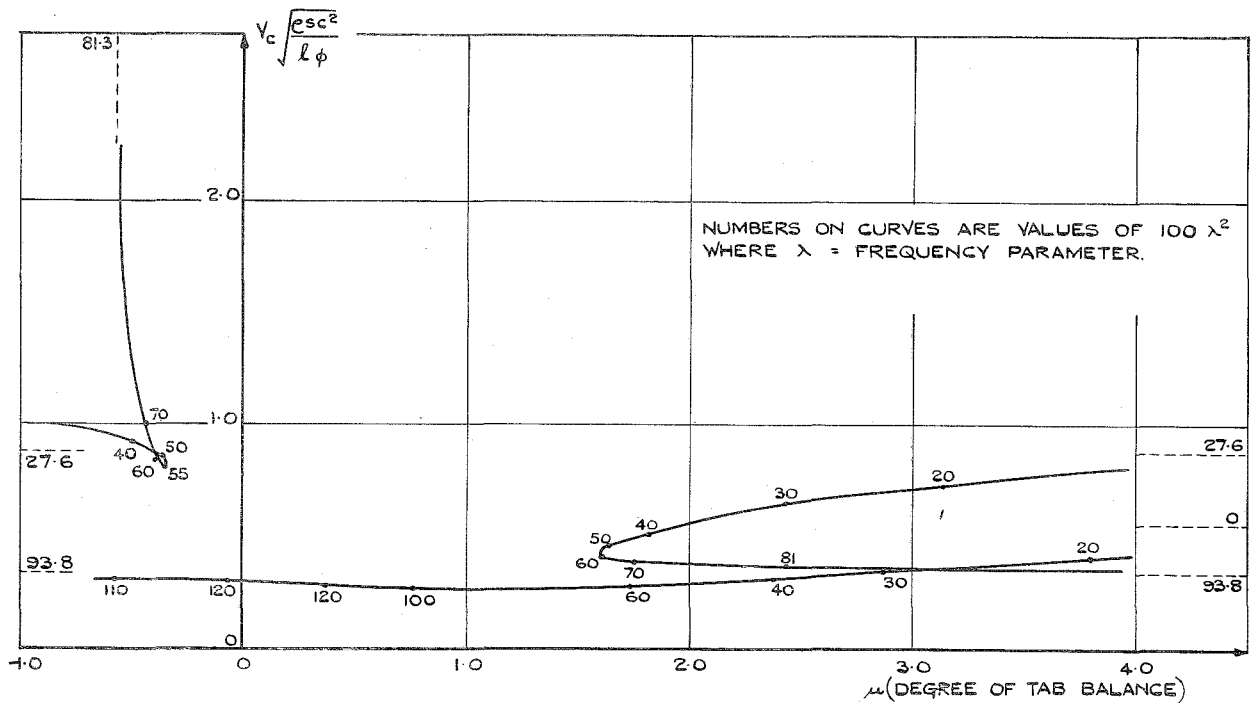

FIG. 8. Variation of Flutter Speed with Tab Mass-balance for Unbalanced Elevator.

$(r = 1; \chi = 0 \text{ for } \mu = 2)$

$\mu = 0$ corresponds to no balance weight on the tab.

Tab balance weight $m = 1.17\mu$ lb.

$\mu = 1$ corresponds to static balance of the tab.

Elevator balance weight $M = 0$ lb.

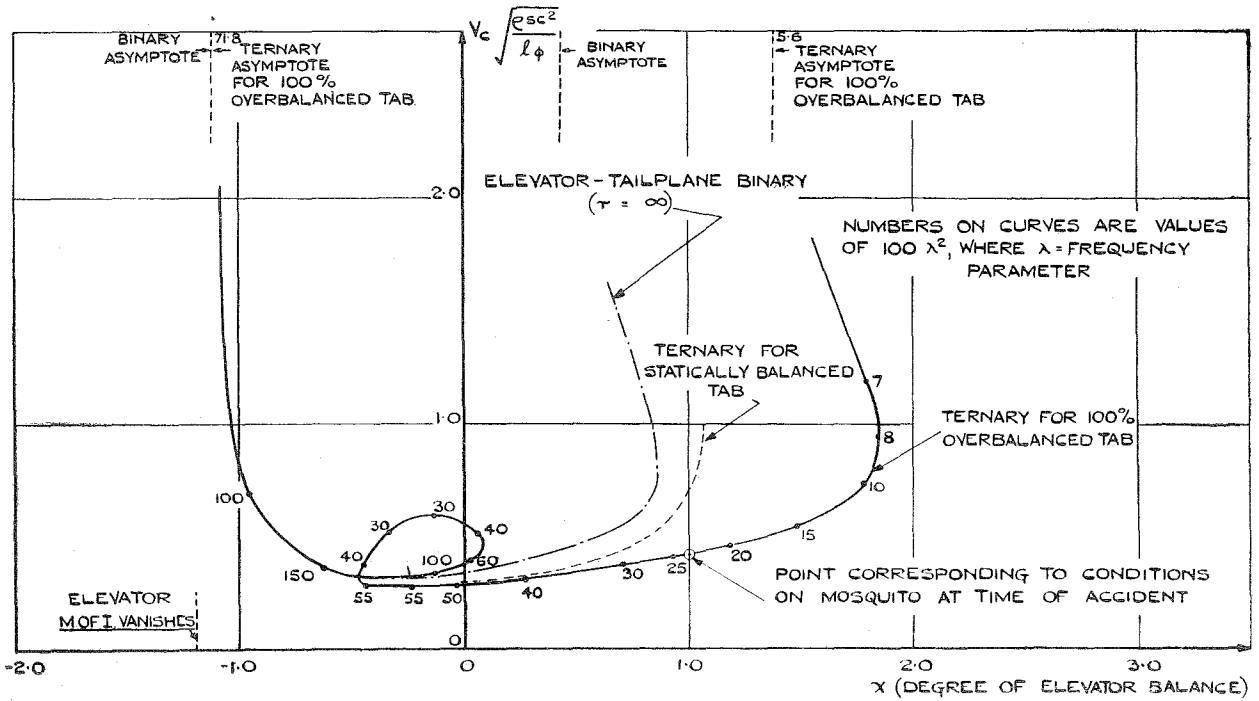

FIG. 9. Variation of Flutter Speed with Elevator Mass-balance for 100 per cent. Overbalanced Tab ($\mu = 2$) and for Statically-balanced Tab ($\mu = 1$).

$\chi = 0$ corresponds to no balance weight on the elevator.

$\chi = 1$ corresponds to static balance of the elevator.

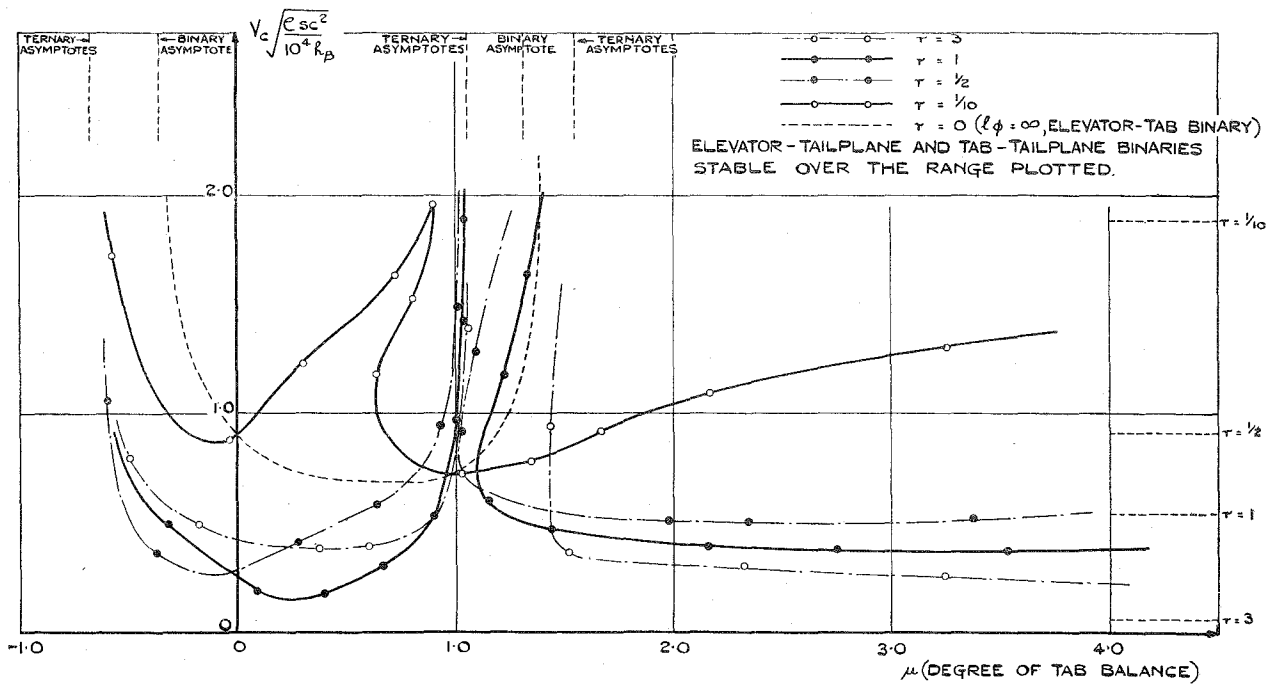

FIG. 10. Variation of Flutter Speed with Tab Mass-balance for Statically-balanced Elevator ($\chi = 1$ for $\mu = 2$) Showing Effect of Variation of the Stiffness Ratio (see Fig. 3).

$$\tau = 10^4 h_{\beta} / l_{\phi}$$

PART II

Experiments on the Influence of Tab Mass-balance on Flutter

By

C. SCRUTON, B.Sc., P. M. RAY, B.A., and MISS D. V. DUNSDON,
of the Aerodynamics Division, N.P.L.

Summary.—Tests made to investigate the effect of tab mass-balance on wing-flexure-aileron-tab flutter show that the ternary flutter may arise from over mass-balance of the tab although the binary types of flutter are stable. This conclusion is in agreement with that reached theoretically in Part I for flutter involving tabs and elevator with fuselage vertical bending.

1. *Introduction.*—*Range and Purpose of the Tests.*—The calculations of Part I made in connection with an accident to an aircraft fitted with a *g*-restrictor indicate that ternary flutter, involving the tailplane vertical motion and the rotations about their hinge lines of the elevator and tab, is possible, although in most cases the corresponding binaries were stable. The essential features of the *g*-restrictor device used were that it entailed heavy mass overbalance of the tab and a pre-loaded spring connection between the tab and the elevator.

The tests to be described in this report were made to obtain qualitative verification of these theoretical conclusions. Since no suitable tail-flutter model was available the tests were made on a model which had been used previously for a spring tab-aileron flutter investigation.³ The degrees of freedom represented in the present investigation were:—

- (1) wing flexure
- (2) aileron rotation about its hinge line
- (3) tab rotation about its hinge line.

The spring connection between tab and aileron was not pre-loaded.

In addition to the tests in which the essential features of the *g*-restrictor device were reproduced a few experiments were made to find the effect of tab mass-overbalance when a spring tab mechanism was fitted.

2. *The Model.*—The rigid wing (*see* Fig. 1) was of rectangular plan form and was attached to the wall of a 4-ft. square wind tunnel by cross-spring hinges which allowed motion in roll, the motion being constrained by helical springs fitted between the wing tip and the roof and floor of the wind tunnel. The aileron, of light wooden construction, was hinged to the wing by two small journal bearings and carried two balance arms offset at equal angles above and below the aileron chord line. No elastic constraint was placed on the aileron. The tab was provided with a single balance arm which was not offset and which projected into a recess cut in the aileron. On the model the elastic characteristics of the *g*-restrictor were simply represented by an elastic constraint applied between tab and aileron, as shown in Fig. 2.

For the tests carried out with a representation of a spring-tab mechanism the arrangement was as shown in Fig. 3. Here the flat spring (*a*), which represents the stiffness of the control circuit, was earthed at one end to the wing by an adjustable mounting and fixed at the other end to the floating arm (*b*). The arm (*b*) was pivoted at the aileron-hinge axis and was elastically connected to the aileron by means of the adjustable clamping link (*d*) and the piano wire spring (*c*). Spring (*c*), which represented the stiffness of the tab mechanism spring, was built into the aileron on the hinge axis.

Connection between F at the top of arm (b) to M on the tab lever was made by a link of hypodermic tubing which was pin-jointed to F and M. The lengths of AF and TM were fixed such that the follow-up ratio $N = AF/TM = 6$.

3. Notation.*

D	Distance between hinge line and trailing edge of tab.
M, λ	Mass added to tab at distance λ forward of the hinge line.
M_s	Mass required to be added to tab, at distance λ forward of the hinge line, to achieve static balance of the tab.
M	Mass added to trailing edge of tab (at 0.93 in. behind the hinge line).
$\sum mx_a$	Mass moment of aileron about its hinge line (positive when C.G. behind hinge line).
l_β	Elastic stiffness of the tab rotating about its hinge line.
V_c, f_c	Critical speed and frequency respectively for onset of flutter.
\bar{V}_c, \bar{f}_c	Critical speed and frequency at which the existing flutter is suppressed.

4. Results.—*The Effect of Tab-balance Mass.*—(a) Tests made with direct spring connection between aileron and tab (*g-restrictor case*) (Fig. 4).—(i) *Ternary flutter.*—Results were obtained for three mass-balance conditions of the aileron, $\sum mx_a > 0$, $\sum mx_a = 0$ and $\sum mx_a < 0$. In Fig. 4 critical speeds for the ternary flutter are shown plotted against M/M_s (the ratio of the tab-balance mass to that required for tab static mass balance) for various stiffnesses (l_β) of the tab-aileron spring connection. With the aileron mass underbalanced and with a high value of l_β , flutter occurred with no tab balance mass. In all other cases tested the system was stable when no tab balance mass was fitted but became unstable as the tab mass balance was increased. Further increase of the mass widened the range of speed over which flutter occurred. The maximum value of the ratio M/M_s for stability was dependent on the values of l_β and $\sum mx_a$. This ratio was only a little in excess of unity for a statically mass balanced aileron but was larger for a mass overbalanced aileron and for both these aileron conditions it increased with increase of l_β . With the mass underbalanced aileron the maximum value of M/M_s for stability was less than unity and decreased as l_β was increased.

(ii) *Binary flutter.*—During the progress of the ternary flutter experiments frequent tests of the stability of the three binary case were made. No wing-flexure-tab or tab-aileron flutter was observed and wing-flexure-aileron flutter occurred only when $\sum mx_a > 0$.

(b) *Tests made with representation of a spring-tab mechanism* (Fig. 5).—The results of these tests, plotted in Fig. 5, show the same general characteristics as those described above. The system was stable for low values of the tab-balance mass, but flutter was produced by increasing the mass to a value greater than that required for static mass-balance of the tab. This effect was found not only when the mass was added at the neutral point ($\lambda = D/7$) but also when it was fitted to a shorter arm ($\lambda = 2D/21$).

5. *The Effect of Mass Added to the Tab Trailing Edge* (Fig. 6).—The results of tests of the ternary and of the binary aileron tab flutter are shown plotted in Fig. 6.

In both cases the system was stable with no mass, and flutter was produced by the addition of mass to the trailing edge; further addition of mass decreased the critical speed. For both conditions of the aileron mass-balanced tested, $\sum mx_a = 0$ and $\sum mx_a > 0$, a point of discontinuity was found in the curve of V_c against M_i/M_s . This point was marked by a change

* The notation used in Part II does not accord with that used in Part I.

in the slope of the curve and by a change in the flutter mode. For some values of the tab balance mass the critical speeds for the ternary flutter with the aileron statically mass-balanced were lower than those for the corresponding binary tab-aileron flutter.

6. *Conclusion.*—The main conclusion to be drawn from the tests described in section 4 is that a wing-flexure-aileron-tab system with a mass-overbalanced tab is liable to flutter although the corresponding binary cases may be stable. This conclusion is also valid when a spring-tab mechanism is fitted and the tab-balance mass is added within the limiting length for the tab-balance arm.

This conclusion agrees with that reached theoretically in Part I for fuselage vertical-bending-elevator-tab flutter.

REFERENCES

<i>No.</i>	<i>Author</i>	<i>Title, etc.</i>
1.	H. Voigt and F. Walter	Windkanalversuche über das Schwingungsverhalten eines Flügels mit Flettner-Hilfsrudder (Wind-tunnel Experiments on the Flutter Behaviour of a Wing with Servo Tab). <i>Deutsche Luftfahrtforschung</i> F.B. Nr. 595.
2.	H. Wittmeyer	Theoretical Investigations of the Flutter Characteristics of Wings and Tail Units with Control Surfaces and Tabs. R.A.E. Library Translation No. 196. A.R.C. 11,058. October, 1947. (Unpublished.)
3.	C. Scruton, J. Williams and C. J. Miles	Experiments on Binary Aileron-tab Flutter. A.R.C. 5917. July, 1942. (Unpublished.)
4.	H. A. Jahn	Comparison of the Experimental Wing-Aileron Derivatives of R. & M. 1155 with Two-dimensional Vortex Sheet Derivatives. A.R.C. 8192. R.A.E. Tech. Note. No. S.M.E. 276. September, 1944. (Unpublished.)
5.	H. A. Jahn and T. B. Boss	Aileron Spring-Tab Flutter on the F.9/40. R.A.E. S.M.E. Memo. No. 3. (Unpublished.)
6.	C. F. E. Regnier	Pressure Exploration on the Elevator Horn Balance and Hinge Moment Measurements on the Elevator of a Twin-engined Fighter Bomber (Mosquito) in the R.A.E. 24-ft. Wind Tunnel. A.R.C. 8302. R.A.E. Report No. Aero 1968. October, 1944. (Unpublished.)
7.	A. R. Collar and G. D. Sharpe	Mass Balance for Spring-tab Flutter Prevention. R. & M. 2637 June, 1946
8.	G. D. Sharpe	Consideration of the Effect of Tab Dimensions on Spring-tab Flutter. R. & M. 2637. June, 1946.

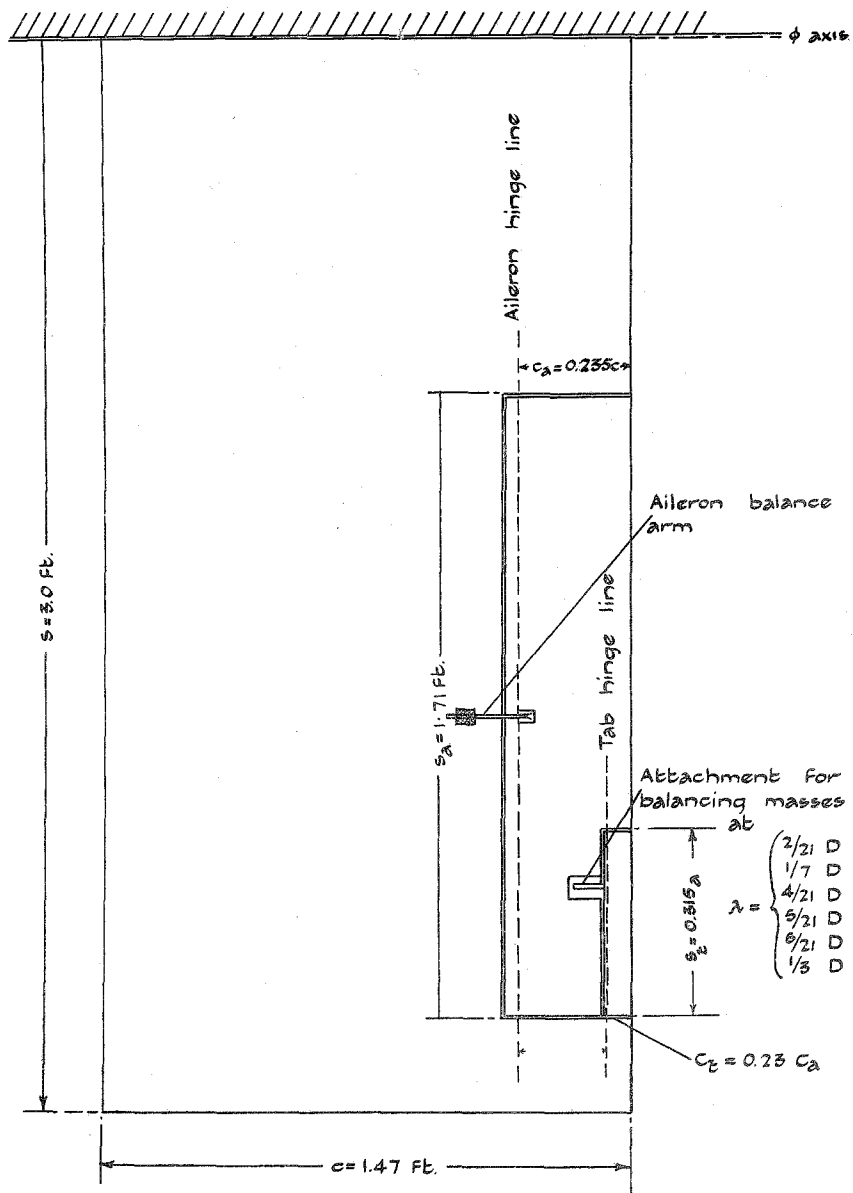

FIG. 1. General Arrangement of the Model.

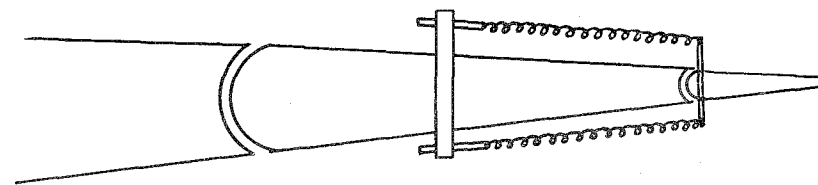

FIG. 2. Direct Spring Connection between Aileron and Tab (g-restrictor case).

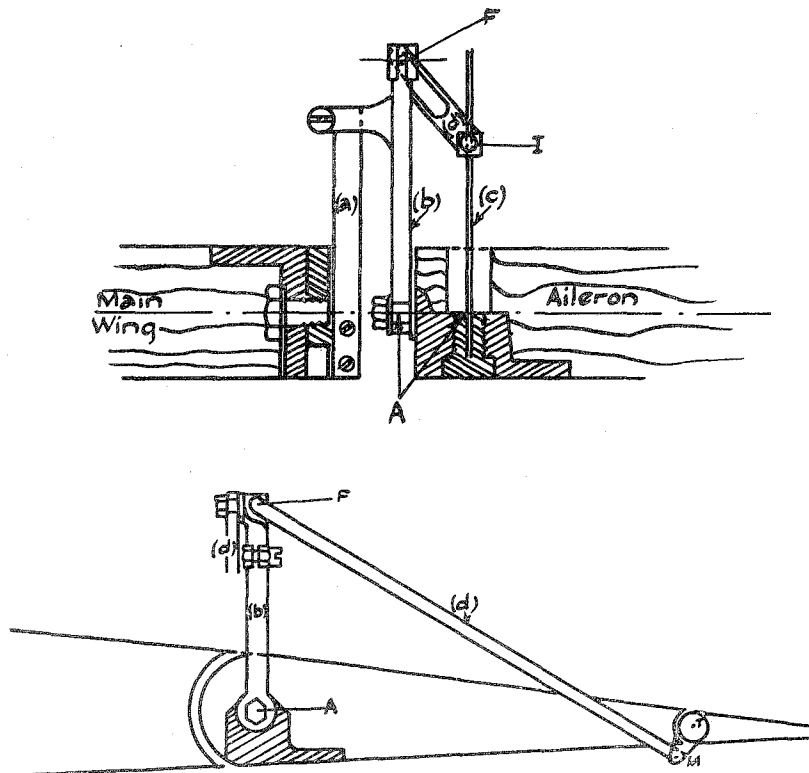

FIG. 3. Model Representation of the Elastic Characteristics of a Non-preloaded Spring-tab Control.

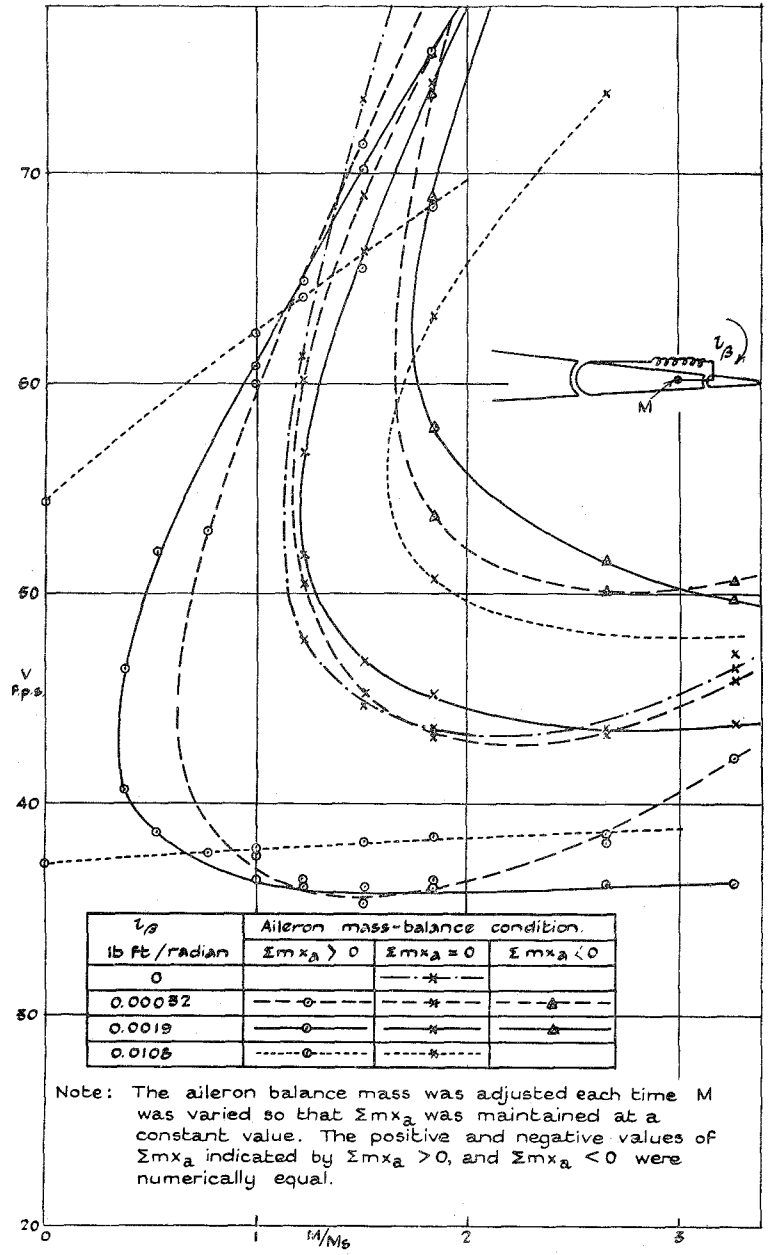

FIG. 4. Effect of Tab-balance Mass on Wing Flexure-Aileron-Tab Flutter—Direct Spring Connection between Aileron and Tab.

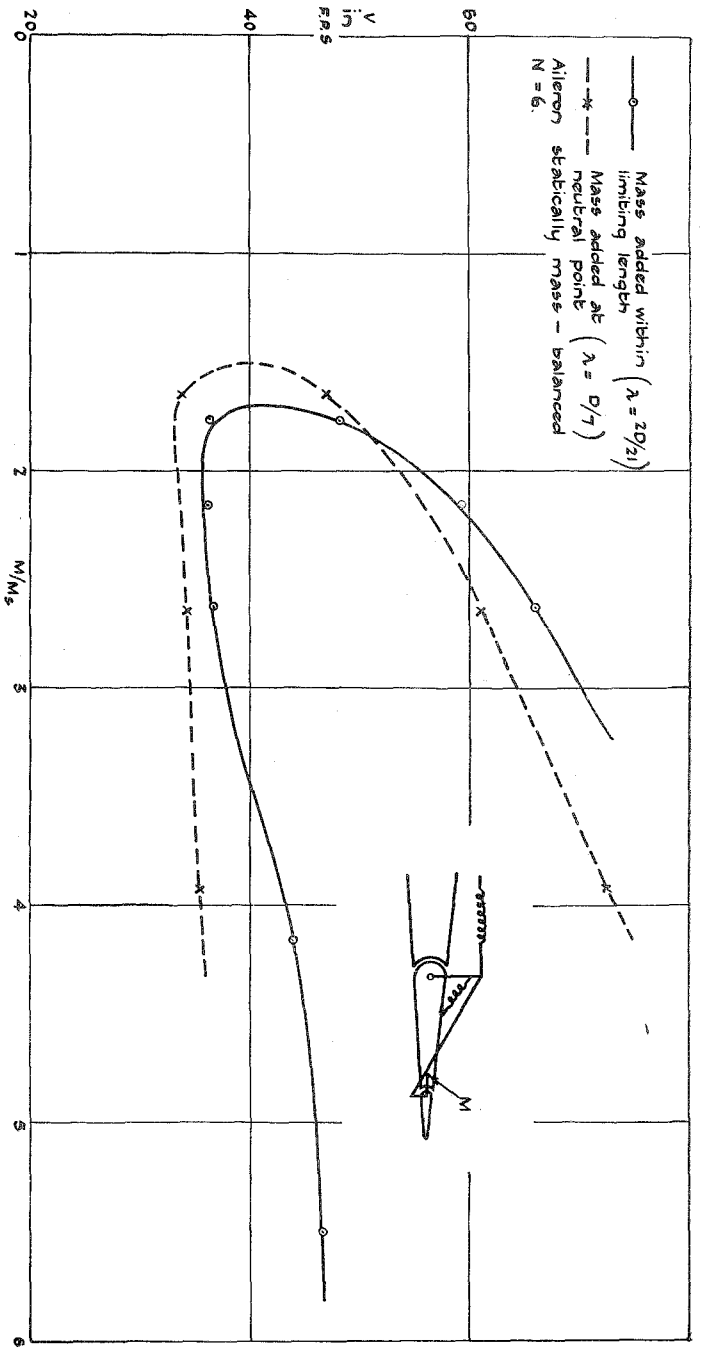

FIG. 5. Effect of Tab-balance Mass on Wing Flexure—Aileron-Tab Flutter Test Made with Representation of Spring-tab Mechanism

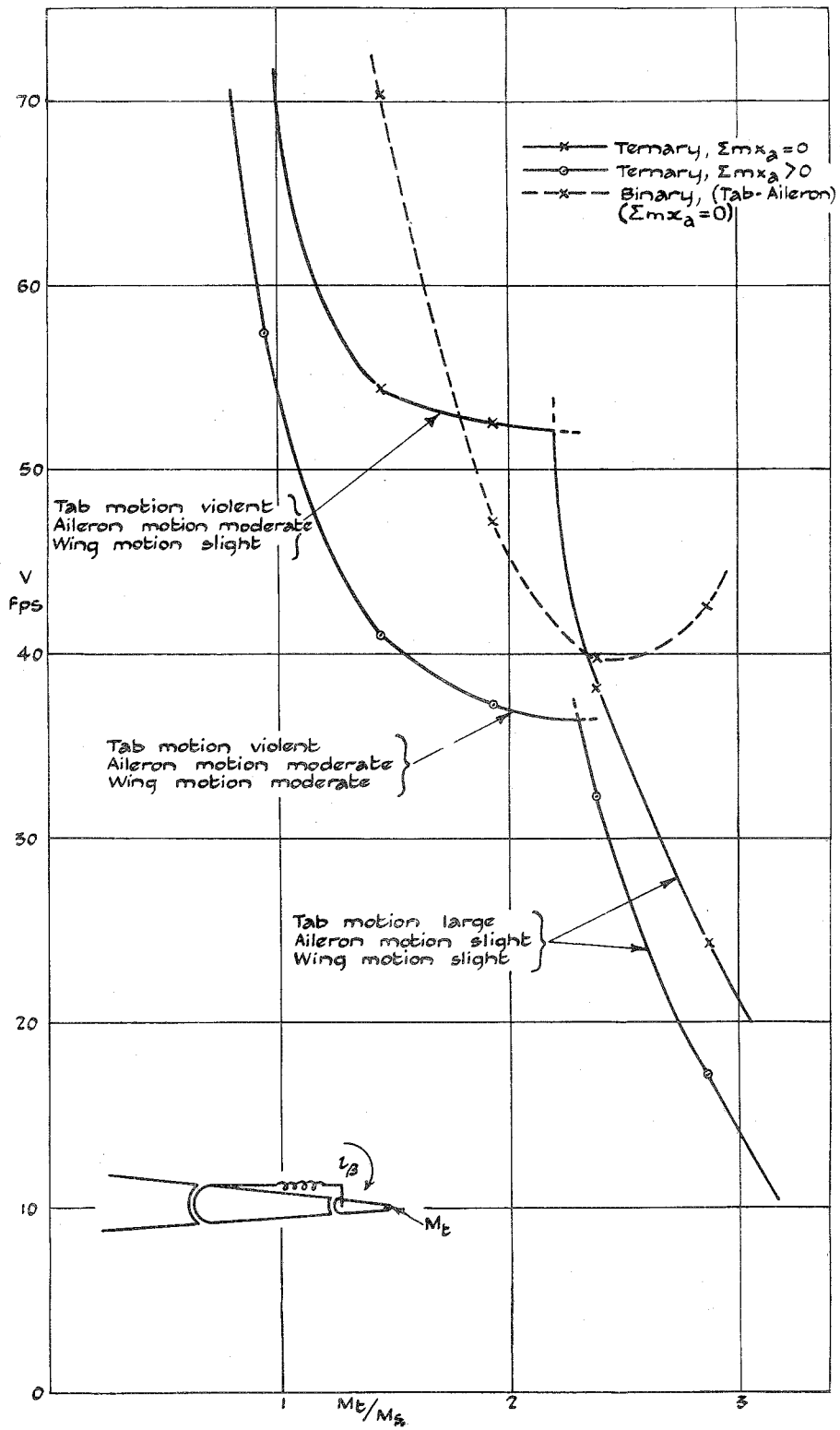

Fig. 6. Effect of Mass Added to Tab Trailing Edge.

Publications of the Aeronautical Research Committee

TECHNICAL REPORTS OF THE AERONAUTICAL RESEARCH COMMITTEE—

- 1934-35 Vol. I. Aerodynamics. 40s. (40s. 8d.)
Vol. II. Seaplanes, Structures, Engines, Materials, etc.
40s. (40s. 8d.)
- 1935-36 Vol. I. Aerodynamics. 30s. (30s. 7d.)
Vol. II. Structures, Flutter, Engines, Seaplanes, etc.
30s. (30s. 7d.)
- 1936 Vol. I. Aerodynamics General, Performance, Airscrews,
Flutter and Spinning. 40s. (40s. 9d.)
Vol. II. Stability and Control, Structures, Seaplanes,
Engines, etc. 50s. (50s. 10d.)
- 1937 Vol. I. Aerodynamics General, Performance, Airscrews,
Flutter and Spinning. 40s. (40s. 9d.)
Vol. II. Stability and Control, Structures, Seaplanes,
Engines, etc. 60s. (61s.)
- 1938 Vol. I. Aerodynamics General, Performance, Airscrews,
50s. (51s.)
Vol. II. Stability and Control, Flutter, Structures, Sea-
planes, Wind Tunnels, Materials. 30s. (30s. 9d.)
- 1939 Vol. I. Aerodynamics General, Performance, Airscrews,
Engines. 50s. (50s. 11d.)
Vol. II. Stability and Control, Flutter and Vibration,
Instruments, Structures, Seaplanes, etc. 63s.
(64s. 2d.)

ANNUAL REPORTS OF THE AERONAUTICAL RESEARCH COMMITTEE—

- 1933-34 1s. 6d. (1s. 8d.)
1934-35 1s. 6d. (1s. 8d.)
April 1, 1935 to December 31, 1936. 4s. (4s. 4d.)
1937 2s. (2s. 2d.)
1938 1s. 6d. (1s. 8d.)
1939-48 *In the press*

INDEXES TO THE TECHNICAL REPORTS OF THE ADVISORY COMMITTEE ON AERONAUTICS—

- December 1, 1936 — June 30, 1939. R. & M. No. 1850. 1s. 3d. (1s. 5d.)
July 1, 1939 — June 30, 1945. R. & M. No. 1950. 1s. (1s. 2d.)
July 1, 1945 — June 30, 1946. R. & M. No. 2050. 1s. (1s. 1d.)
July 1, 1946 — December 31, 1946. R. & M. No. 2150. 1s. 3d. (1s. 4d.)
January 1, 1947 — June 30, 1947. R. & M. No. 2250. 1s. 3d. (1s. 4d.)

Prices in brackets include postage.

Obtainable from

His Majesty's Stationery Office

York House, Kingsway, LONDON, W.C.2 429 Oxford Street, LONDON, W.1
P.O. Box 569, LONDON, S.E.1

13a Castle Street, EDINBURGH, 2 1 St. Andrew's Crescent, CARDIFF
39 King Street, MANCHESTER, 2 Tower Lane, BRISTOL, 1
2 Edmund Street, BIRMINGHAM, 3 80 Chichester Street, BELFAST

or through any bookseller.

