



MINISTRY OF SUPPLY

AERONAUTICAL RESEARCH COUNCIL
REPORTS AND MEMORANDA

Low-speed Model Tests on Two “V” Wings

By

J. TROUNCER, M.A., and D. KETTLE

Crown Copyright Reserved

LONDON: HIS MAJESTY'S STATIONERY OFFICE

1951

PRICE £1 2s 6d NET

Low-speed Model Tests on Two "V" Wings

By

J. TROUNCER, M.A., and D. KETTLE

COMMUNICATED BY THE PRINCIPAL DIRECTOR OF SCIENTIFIC RESEARCH (AIR),
MINISTRY OF SUPPLY

Reports and Memoranda No. 2364

*December, 1947**

Summary.—Wind tunnel tests were required for comparison with flight tests on two "V" wing tailless gliders of 28·4 deg. and 36·4 deg. sweepback.

The main part of the work consisted of longitudinal, lateral and directional stability tests on the two wings, but pressure-plotting tests on the wing of larger sweepback and an investigation of anti-tip stalling devices was also included.

Tip slats were found to be the most effective of the devices tried in the present experiments for overcoming the drawback of the premature tip stall.

LIST OF CONTENTS

1. Introduction
2. Range of Investigation
3. Definitions

PART I.—*Longitudinal and Lateral Stability Tests on Two "V" Wings of 28·4 deg. and 36·4 deg. Sweepback, without Anti Tip-stalling Devices (Tests made in No. 1. 11½-ft. tunnel).*

4. Details of Tests
5. Range of Investigation
6. Results
 - 6.1. Lift
 - 6.2. Longitudinal Stability
 - 6.3. Longitudinal Trim
 - 6.4. Drag
 - 6.5. Lateral and Directional Stability
 - 6.6. Elevon Power
 - 6.7. Rudder Power
 - 6.71. Conventional rudders
 - 6.72. Drag rudders
 - 6.8. Elevon Power Behind Drag Rudders

* A collection of R.A.E. reports published between August, 1944 and October, 1946 (for complete list see Appendix I).

LIST OF CONTENTS—*continued*

PART II.—*Tests of Anti Tip-stalling Devices on Two "V" Wings of 28·4 deg. and 36·4 deg. Sweepback (Tests made in No. 1, 11½-ft. tunnel).*

- 7. Introduction
- 8. Range of Investigation
- 9. Variable Incidence Tips
 - 9.1. Details of Tests and Range of Investigation
 - 9.2. Results
- 10. Tip Slats
 - 10.1. Details of Tests and Range of Investigation
 - 10.2. Results
- 11. Inboard Fins
 - 11.1 Details of Tests and Range of Investigation
 - 11.2. Results
 - 11.21. Longitudinal stability and trim
 - 11.211. Fin position
 - 11.212. Fin size and fin chord : local chord ratio
 - 11.22. Profile drag
 - 11.23. Lateral and directional stability

PART III.—*Force Measurements and Pressure Plotting Tests on a 36·4 deg. Sweepback "V" Wing (Tests made in the 24-ft. tunnel).*

- 12. Introduction
- 13. Force Measurements
 - 13.1. Details of Tests
 - 13.2. Range of Investigation
 - 13.3. Results
 - 13.31. Chordwise gaps unsealed
 - 13.32. Effect of chordwise gaps
- 14. Pressure Plotting Tests
 - 14.1. Details of Tests
 - 14.2. Range of Investigation
 - 14.3. Presentation of Results

15. Conclusions

References

APPENDIX I.—List of R.A.E. reports from which the present report is compiled

Tables

1. *Introduction.*—The idea of a tailless aircraft offers certain obvious advantages over the more conventional layouts, the chief of these being the reduction in drag one should obtain from the cleanness of the design. If the wing size is increased until the fuselage is also unnecessary and the design becomes an all-wing aircraft this reduction is considerable. On the other hand stability and control problems are more complex on these than on conventional layouts and also less understood at present.

In order to obtain more data on this type of aircraft a research programme was planned which included full scale and wind tunnel tests on three tailless gliders as follows:—

- (a) A “V” wing planform with 28·4 deg. overall sweepback*.
- (b) A “V” wing planform with 36·4 deg. overall sweepback.
- (c) A “U” wing planform with 28·4 deg. overall sweepback.

These wings were all designed with a small fuselage to house the cockpit. A fourth glider of different planform which corresponds more nearly to an all-wing design is also being built, but no tunnel tests are being made on this.

The present report includes the results of the tunnel tests made on the two “V” wing planforms. The results of the tests on the “U” wing are given in a further report (Ref. 1) (1947).

2. *Range of Investigation.*—The tests were made between 1944 and 1946 in the No. 1, 11½-ft. tunnel and the 24-ft. tunnel of the Royal Aircraft Establishment.

Longitudinal and lateral stability tests were made on two 1/5·67 scale models in the No. 1, 11½-ft. tunnel and pressure plotting tests combined with force measurements were made on a 1/3·78 scale model of the 36·4 deg. sweepback wing in the 24-ft. tunnel. For the purpose of this report the results have been separated into three parts.

- | | | |
|--|---|---|
| <p>Part I. Basic longitudinal and lateral stability tests on the two small scale models without any anti tip-stalling devices fitted.</p> <p>Part II. Tests made on these two models with devices intended to cure the tip stall, i.e. variable incidence tips, tip slats and inboard fins.</p> <p>Part III. Pressure plotting tests and force measurements on the larger scale 36·4 deg. sweepback model.</p> | } | <p>Tests made in the No. 1, 11½-ft. tunnel.</p> <p>Tests made in the 24-ft. tunnel.</p> |
|--|---|---|

3. *Definitions.*—The following definitions are used throughout the report:—

Sweepback angle: measured from the centre line of the aircraft *i.e.* the angle between the *y*-axis and the projection of the line PR (*see* Fig. 1) on the *xy*-plane.

Dihedral angle: measured on the swept-back portion only *i.e.* the angle between the *y*-axis and the projection of the line QR (*see* Fig. 1) on the *yz*-plane.

(P.Q.R. are sectional quarter-chord points. The *xyz* axes are defined as in all R. and Ms.; for these models the *x*-axis is taken to be parallel to the root chord.)

Incidence: α deg. The angle of incidence of the root chord.

Elevon angles: defined as η_w deg. if measured along wind.
 defined as η_H deg. if measured about the hinge line.

Flap angle: measured about the hinge line.

Angle of variable incidence tips: measured along wind.

* The wings all have straight centre sections and the overall sweepback is defined by the line joining the quarter-chord at the root to the quarter-chord at the tip.

Standard mean quarter-chord point. The position of this point is defined as \bar{x} , \bar{z} , where

$$\bar{x} = \int_{-b/2}^{+b/2} cx dy \div S \qquad \bar{z} = \int_{-b/2}^{+b/2} cz dy \div S$$

where $S = \int_{-b/2}^{+b/2} c dy =$ gross wing area.

Pitching moments are all referred to an axis through the standard mean quarter-chord point.

PART I

Longitudinal and Lateral Stability Tests on Two "V" Wings of 28.4 deg. and 36.4 deg. Sweepback, without Anti Tip-stalling Devices. (Tests made in No. 1, 11½-ft. Tunnel)

4. *Details of Tests.*—The tests were all made at a windspeed of 120 ft./sec., giving a Reynolds number, based on mean chord, of 10^6 .

Details of the models are given in Tables 1 and 2 and Figs. 1 and 2. The dihedral angles tested were 0.9 deg., 2.9 deg. and 5.0 deg. on the 28.4 deg. sweepback model and 1.1 deg. and 5.0 deg. on the 36.4 deg. case*. The majority of tests were made with the smallest dihedral angle. The three alternative sizes of fin tested on the smaller sweepback wing are shown in Fig. 1, most of the tests being made with the largest fins (T.B.). In the original design the elevon nose shape was as shown in Fig. 1, but this caused a considerable gap and discontinuity in the wing surface. For many of the tests, therefore, it was decided to eliminate this effect by sealing the gap and fairing the surface into the wing section. This was done initially by sealing the gaps with plasticine, but for the later tests on the 28.4 deg. sweepback wing the elevon nose was radiused to give the same effect. Elevon angles were measured along wind and are denoted by η_w deg.

The type of flap used throughout the tests was a split flap of 20 per cent. chord, hinged along the 70 per cent. chord line and open at an angle of 60 deg. about the hinge line. The flaps extended outboard to the elevon and inboard to the junction between the swept-back portion of the wing and the straight centre section. For the tests made without the fuselage the two swept-back portions of the flaps were joined by a straight centre section flap as shown in Fig. 1.

The tunnel corrections for a wing with zero sweepback and the same area and aspect ratio as the present models have been applied to correct the wing incidence and the drag coefficient. Check measurements made on the 36.4 deg. sweepback model in the 24-ft. tunnel†, where conditions should be very close to those in free air, showed very good agreement with the results obtained in the 11½-ft. tunnel.

5. *Range of Investigation.*—The effects of the fuselage, end fins and split flaps on longitudinal stability were measured on both models, the fins for these tests being the largest size (fins T.B., see Fig. 1). The effect of sealing the elevons was also obtained with flaps up. The dihedral angles used were 0.9 deg. on the 28.4 deg. sweepback model and 1.1 deg. on the 36.4 deg. wing. The elevon angles tested were 0 deg. and -10 deg. flaps up, and 0 deg. and -15 deg. flaps down.

Lateral and directional stability tests were made on both models for a range of dihedral angles and the effects of the fuselage, end fins and split flaps were measured at the lowest angle. On the wing of smaller sweepback the three alternative fin sizes shown in Fig. 1 were tested.

Elevon power was measured on both models with the elevons unsealed and on the 28.4 deg. sweepback model with the elevons sealed. Measurements were also made on this model of the rudder power which could be obtained from two sizes of end fin or from four types of drag rudder, and a few readings were taken of the effect of the latter on elevon power.

* See footnote to Table 7.

† These measurements were made on the small scale model and should not be confused with the tests described in Part III of this report.

6. *Results.*—6.1. *Lift* (Tables 4 and 5).—The lift curves for the various cases without flaps (Figs. 4 and 6) all show a large stalling angle and a fairly high value of maximum C_L (1.25 to 1.35). However, due to the stall at the wing tips the slope of the pitching-moment curves changes long before $C_{L\max.}$ is reached (Figs. 5 and 7). This loss in longitudinal stability makes it unlikely that the actual $C_{L\max.}$ could be used in flight and a more useful criterion is probably the value of C_L for which the stability is neutral. With flaps down these effects are less marked with the smaller sweepback angle, but still fairly large with 36.4 deg. sweepback. The following table gives values of $C_{L\max.}$ trimmed and C_L trimmed for neutral stability with flaps down (C.G. at 0.25 \bar{c}):—

TABLE A

	28.4° Sweepback		36.4° Sweepback	
	$C_{L\max.}$ trimmed	C_L trimmed neutral stab.	$C_{L\max.}$ trimmed	C_L trimmed neutral stab.
Wing alone. Flaps 60 deg. (with centre section flap)	1.4	1.3	1.45	1.15
Complete model. Flaps 60 deg. (no centre section flap).	1.35	1.2	1.4	1.15

6.2. *Longitudinal Stability* (Tables 4 and 5).—The following table of neutral point positions and C_{M0} values summarizes the longitudinal stability for the cases tested. The C_L range used was from 0 to 0.75 with flaps up and from 0.5 to 1.1 with flaps down.

TABLE B

	h_n		C_{M0}	
	28.4° sweepback	36.4° sweepback	28.4° sweepback	36.4° sweepback
<i>Elevons sealed</i>				
Wing alone. Flaps 0 deg.	0.32	0.34	0.019	0.022
Wing alone. Flaps 60 deg.	0.34	0.37	0.047	0.077
<i>Elevons unsealed</i>				
Wing alone. Flaps 0 deg.	0.30	0.31	0.019	0.024
Wing and fuselage. Flaps 0 deg.	0.31	0.32	0.017	0.023
Wing, fuselage and fins. Flaps 0 deg.	0.33	0.34	0.021	0.028
Wing, fuselage and fins. Flaps 60 deg.	0.33	0.36	0.025	0.053

Falkner's theory for the wing alone² (1944) gives an h_n of 0.285 for the 28.4 deg. sweepback and 0.30 for the 36.4 deg. sweepback (extrapolated). The tunnel values are therefore about 0.04 \bar{c} behind the estimated positions.

6.3. *Longitudinal Trim.*—The pitching-moment curves on the complete model (Fig. 5) show that there is sufficient elevon power to trim over the whole range of C_L . On the 28.4 deg. sweepback wing the C.G. can be moved forward to 0.235 \bar{c} and the aircraft can still be trimmed with 15 deg. of elevon; on the 36.4 deg. sweepback wing the maximum forward position is 0.21 \bar{c} .

The change of elevator angle to trim when the flaps are lowered at $C_L = 0.5$, is about 1 deg. for the 28.4 deg. sweepback and 3 deg. for the 36.4 deg. sweepback wing, the flaps causing a nose-up change of trim in both cases.

6.4. *Drag* (Tables 4 and 5).—Figs. 8 and 9 show the profile drags (defined as $C_{D0} = C_D - \frac{1}{\pi A} C_L^2$) for the various model conditions. The effect of unsealing the elevons is very marked at high C_L 's, causing an increase of C_{D0} of the order of 50 per cent.

The changes in drag with C_L are summarized in the Table below, which gives the values of K ($K = \frac{\pi A}{d(C_L)^2} \cdot \frac{dC_D}{d(C_L)^2}$).

TABLE C

	K	
	28.4° Sweepback	36.4° Sweepback
Wing alone, elevons sealed	1.12	1.08
Wing alone, elevons unsealed	1.41	1.27
Wing and body, elevons unsealed	1.32	1.31
Wing, body and fins, elevons unsealed	1.27	1.28

6.5. *Lateral and Directional Stability* (Tables 6–9).—In Tables 8 and 9 values of l_v , n_v and y_v are given as mean values for a range of side-slip angles $\beta = \pm 5$ deg. The detailed results for various angles of side-slip are given in Tables 6 and 7, but generally, except near the stall, the coefficients C_l , C_m , C_n vary linearly with β .

The following table summarizes the lateral derivatives:—

TABLE D

28.4 deg. Sweepback. $\gamma = 0.9$ deg.

Condition of Model	n_v			l_v			y_v		
	$C_L = 0$	$C_L = 0.5$	$C_L = 1.1$	$C_L = 0$	$C_L = 0.5$	$C_L = 1.1$	$C_L = 0$	$C_L = 0.5$	$C_L = 1.1$
<i>Elevons sealed</i>									
Wing alone. Flaps 0 deg.	0.007	0.013		−0.002	−0.065		−0.008	−0.008	
Wing alone. Flaps 60 deg.		0.014	0.038		−0.051	−0.131		−0.021	−0.026
<i>Elevons unsealed</i>									
Wing alone. Flaps 0 deg.	0.006	0.018		0.003	−0.062		−0.005	−0.008	
Wing and fuselage. Flaps 0 deg.	−0.005	0.005		0.016	−0.048		−0.025	−0.028	
Wing, fuselage and fins. Flaps 0 deg.	0.054	0.051		−0.019	−0.070		−0.178	−0.164	
Wing, fuselage and fins. Flaps 60 deg.		0.051	0.073		−0.077	−0.115		−0.168	−0.144

36.4 deg. Sweepback. $\gamma = 0.9$ deg.

Condition of Model	n_v			l_v			y_v		
	$C_L = 0$	$C_L = 0.5$	$C_L = 1.1$	$C_L = 0$	$C_L = 0.5$	$C_L = 1.1$	$C_L = 0$	$C_L = 0.5$	$C_L = 1.1$
<i>Elevons sealed</i>									
Wing alone. Flaps 0 deg.	0.003	0.016		-0.010	-0.093		-0.008	-0.011	
Wing alone. Flaps 60 deg.		0.012	0.045		-0.078	-0.190		-0.023	-0.028
<i>Elevons unsealed</i>									
Wing alone. Flaps 0 deg.	0.002	0.017		0.001	-0.082		-0.008	-0.015	
Wing and fuselage. Flaps 0 deg.	-0.007	0.005		0.024	-0.063		-0.032	-0.042	
Wing, fuselage and fins. Flaps 0 deg.	0.070	0.063		-0.006	-0.082		-0.184	-0.175	
Wing, fuselage and fins. Flaps 60 deg.		0.067	0.088		-0.084	-0.142		-0.190	-0.175

The effects of dihedral, fuselage, fins and flaps on the lateral derivatives are shown in more detail in Figs. 10-17. Some of the curves have been drawn with a broken line since the tests were not made at sufficient incidences to define them accurately, particularly near the stall.

Fig. 28 shows the effect of different fin sizes on n_v and y_v on the wing with 28.4 deg. sweepback.

6.6. *Elevon Power* (Tables 10 and 11).—The initial tests of elevon power on both wings were made with the elevons unsealed. The results of these tests are shown in Figs. 18, 20, 22, and 24. Further tests were then made on the 28.4 deg. sweepback model with the elevons sealed. These results are plotted in Figs. 19, 21, 23, and 25, and comparison shows that the effect of sealing the elevons is to increase the elevon power by about 50 per cent.

The following table gives the rolling moments and the adverse yawing moments produced by elevon movements of ± 15 deg. from their position for trimmed flight at various lift coefficients.

TABLE E
Elevon Power. Wing alone

	Port elevon 15° down } from trimmed Starboard elevon 15° up } position	
	$10^3 \Delta C_n$	$10^3 \Delta C_l$
36.4 deg. Sweepback Elevons unsealed		
Flaps 0 deg. $C_L = 0$	-4.0	44
$C_L = 0.6$	-3.0	43
$C_L = 0.8$	-3.7	38
Flaps 60 deg. $C_L = 0.5$	-1.3	49
$C_L = 1.0$	+1.8	47
28.4 deg. Sweepback Elevons unsealed		
Flaps 0 deg. $C_L = 0.3$	-1.4	47
28.4 deg. Sweepback Elevons sealed		
Flaps 0 deg. $C_L = 0.3$	-1.3	71
$C_L = 0.9$	-2.0	72
Flaps 60 deg. $C_L = 0.6$	1.3	75
$C_L = 1.1$	2.2	69
$C_L = 1.4$	0	67

6.7. *Rudder Power* (Tables 12A and 12B).—Two separate types of yawing moment control were tested on the wing of 28.4 deg. sweepback, flaps up.

- (a) A conventional type of rudder which formed part of the end fin, and
- (b) Drag rudders, designed as an alternative to end fins, the advantage being the cleanness of the wing when the rudders are in the closed position.

6.71. *Conventional Rudders* (Table 12A).—Details of these rudders are given in Table 1 and Fig. 1. Rudder power was measured for both sizes of top fin, the bottom portion of the fin being attached in each case. The rudders were designed to move only outboard so that only one rudder was in use at a time. The results of the measurements are shown in Fig. 26. Even with the larger fin the rudder power is only of the order of half that of a conventional aircraft, but, as there is no swing due to slip-stream to correct in this case, this is probably sufficient.

6.72. *Drag Rudders* (Table 12B).—Four different drag-rudder arrangements were tested, two being of the double split type and two of the spoiler type. These are summarised below and shown in Fig. 3.

	Type	Rudder chord per cent. local chord	Max. angle when open	Span* per cent. semi-span	Hinge line position
Rudders 1 (A)	Double split ..	0.20	60°	0.15	Along 80 per cent. chord line
Rudders 1 (B)	Double split ..	0.20	60°	0.15	Across wind.
Rudders 2 (A)	Spoilers ..	0.10	90°	0.20	Along 60 per cent. chord line.
Rudders 2 (B)	Spoilers ..	0.10	90°	0.20	Across wind.

* In each case the rudders extended inboard from the wing tip chord.

The effect of the rudders on the six component forces and moments was measured and some measurements were also taken of the elevon power behind rudders 2 (A) (*see* section 6.8).

The following table gives the yawing moment and the efficiency, based on yawing moment : drag ratio, of the four different rudders tested:—

TABLE F

Rudders	$10^3 C_r$ ($C_L = 0.47$)	Yawing moment
		Drag
Rudders 1 (A) (Split type. Hinged at 80 per cent chord)	7.25	32.1
Rudders 1 (B) (Split type. Hinged across wind) ..	6.43	26.2
Rudders 2 (A) (Spoiler type. Hinged at 60 per cent. chord)	8.46	28.0
Rudders 2 (B) (Spoiler type. Hinged across wind) ..	10.88	25.6

From this table we see that the crosswind position (rudders 1 (B) and 2 (B)) is inefficient, giving a high drag increment in relation to the yawing moment produced. Of the remaining two types rudders 1 (A) (split type) are more efficient, but a larger yawing moment is obtained with rudders 2 (A) (spoiler type). Rudders 2 (A) also have the advantage of being set entirely ahead of the elevon whereas with rudders 1 (A) the elevon span is limited as the portion covered by these rudders could not be operated (*see* Fig. 3). Rudders 2 (A) give a yawing moment which corresponds to about 17 deg. deflection of the larger size of conventional rudder.

Table 12B gives the effect of rudders 1 (A) and 2 (A) on lift, roll and pitching moment. This is negligible with rudders 1 (A) but quite appreciable with rudders 2 (A) when $\Delta C_M = 0.013$ and $\Delta 10^3 C_l = -8.64$ at high C_L 's.

6.8. *Elevon Power Behind Drag Rudders* (Table 13).—Figs. 29 and 30 show the large reduction in elevon power due to opening drag rudders of type 2 (A) *i.e.* spoilers hinged along the 60 per cent. chord line. The rudders reduce the efficiency of the whole elevon behind them by nearly a half. Since the rudders would only operate on one side at a time, this represents about 25 per cent. loss of total elevon power.

In considering the consequent changes in trim account must be taken of the changes in moment due to opening the rudders. These act so as to counteract the loss of elevon power and Fig. 27 shows that in fact the resulting changes in trim are small.

PART II

Tests of Anti Tip-stalling Devices on Two "V" Wings of 28.4 deg. and 36.4 deg. Sweepback (Tests made in No. 1, 11½-ft. Tunnel)

7. *Introduction.*—The initial tests on the two wings recorded in Part I showed that, if this type of design is to be a practical proposition, some means must be found of curing the tip-stalling tendency of the wings.

Photographs of the behaviour of surface tufts on the 28.4 deg. sweepback wing and on a "U" wing of the same overall sweepback (Figs. 31 and 32) show that the stall starts just inboard from the tip and spreads rapidly over the outer portion of the span. They also show the large outflow that exists on the upper surface of such wings. The reason for the stall starting inboard from the tip rather than at the tip itself may be the 5 deg. washout that there is between the root and tip sections on these wings.

8. *Range of Investigation.*—Three alternative methods of curing this tip stall were tried.

(1) *Variable Incidence Tips.*—The principle of these is the same as that of washout. The whole tip section of the span is designed to rotate to a negative angle relative to the main wing and by this local reduction of incidence the stall on this portion of the span should be delayed.

(2) *Tip Slats.*—These are a standard method of delaying a stall by reducing the large pressure gradients which occur round the peak suction for the section. In this case they were designed to cover the tip portion of the span and to delay the local stall until the advent of the root stall.

(3) *Inboard Fins.*—One of the chief causes of the tip stall is the thickening of the boundary layer at the tips due to the large outflow, hence a device which stops this cross flow should have a favourable effect on the stall. The inboard fins were tested with the object of finding what size of fin is needed to have any appreciable effect.

The results with these three types of anti tip-stalling device are given separately in the following paragraphs.

9. *Variable Incidence Tips.*—9.1. *Details of Tests and Range of Investigation.*—The initial tests were made on the 28.4 deg. sweepback model with the wing tips cut at 0.23 of the semi-span inboard from the tip and hinged to rotate through angles up to -10 deg. relative to the main wing (*see* Fig. 1). Measurements of lift, drag and pitching moment were made on the wing alone, with flaps up and down and elevon angles of 0 deg. and -10 deg., for angles of the wing tips of 0 deg., -5 deg. and -10 deg.

Although these tests showed little improvement in the stalling characteristics of this model it was felt that the variable incidence tips might prove more effective on the larger sweepback model if increased in span and made to rotate through a larger angle than before. It was also thought desirable to have a direct comparison between the effects of variable-incidence tips and tip slats on the same model, the slat tests having been made on the 36·4 deg. sweepback wing. Further tests were therefore made on this model with the tips cut at 0·30 of the semi-span and hinged to rotate through angles up to -20 deg. relative to the main wing, the hinge line being, as before, the 27·5 per cent. chord line.

For all the tests with variable-incidence tips when the tips were set at 0 deg. to the wing the gaps between the main wing and the tips were sealed; with the tips at a negative angle tests were made with the gaps sealed and unsealed. The direct effect of sealing the gaps was measured in one case with the tips at -10 deg. and the flaps down.*

9.2. *Results* (Tables 14 and 15).—The following table summarises the longitudinal stability for the cases tested on the 28·4 deg. sweepback wing, previous results being included to provide comparison.

Two C.G. positions are given to show that a backward movement of the C.G. would accentuate the effects found with the C.G. at the mean quarter-chord point.

TABLE G
28·4 deg. Sweepback. Wing alone.
Longitudinal Stability with Variable Incidence Tips

	C.G. at 0·25 \bar{c}		C.G. at 0·30 \bar{c}	
	$C_{L\max}$ trimmed	C_L trimmed neutral stab.	$C_{L\max}$ trimmed	C_L trimmed neutral stab.
<i>Flaps 0 deg.</i>				
Trimmed by elevon ..	1·35	0·95		
Trimmed by V.I. tips ..	1·3	1·0		
<i>Flaps 60 deg. (with centre section flap)</i>				
Trimmed by elevon ..	1·4	1·3	1·5	1·3
Trimmed by V.I. tips ..	1·4	1·35	1·5	1·3

With the variable-incidence tips set at a negative angle, surface tufts showed that, although the tips remained unstalled over the whole incidence range, a stall developed inboard of the gap at a C_L of about 1·0 making the unstalled tip ineffective and leaving the stability unimproved both with flaps up and down (Figs. 38, 40). With the gaps between the tips and the main wing sealed this stall occurs at a slightly later incidence, but there is still little improvement in the stability compared with the tips at zero incidence (Fig. 41).

On the 36·4 deg. sweepback wing the variable incidence tips again show little improvement in the stalling characteristics in spite of their larger span and greater angle of deflection. Although they reduce the instability near the stall they actually decrease the lift coefficient at which the instability sets in, both with flaps up and with flaps down (Figs. 39 and 42).

On this wing the pitching moments with the model in its basic condition with tips 0 deg. were slightly different from those obtained in the original tests, the instability due to the tip stall occurring at a lift coefficient of $C_L = 1·05$ instead of $C_L = 0·85$. The maximum lift coefficient at the stall of the whole wing was the same in both tests. This may have been due to changes in the condition of the model due to modifications which had been made to it. It was not, however, possible to check this.

* For a note on the effect of unsealing the gaps when the tips are at 0 deg. see section 13.32 of Part III.

10. *Tip Slats.*—10.1. *Details of Tests and Range of Investigation.*—The tests with tip slats were all made on the 36·4 deg. sweepback model. Lift, drag and pitching moment were measured on the complete model with two alternative slat spans, 40 per cent. and 25 per cent., and on the wing alone with the smaller span of slat only. Both tests were made with flaps up and down. The slats were of the plaster type and details of these are given in Fig. 33. Elevon power with slats open was also measured to compare with the previous results with slats closed, the elevons in this case being in the original unsealed condition.

10.2. *Results* (Table 16).—The longitudinal stability for the complete model with and without slats is given below :—

TABLE H
36·4 deg. Sweepback. Complete model
Longitudinal Stability with Tip Slats

	C.G. at 0·25 \bar{z}	
	$C_{L \max.}$ trimmed	C_L trimmed neutral stab.
<i>Flaps 0 deg.</i>		
Slats closed	1·35	0·9
Slats open (40 per cent. span)	1·35	1·35
<i>Flaps 60 deg. (no centre section flap)</i>		
Slats closed	1·4	1·5
Slats open (40 per cent. span)	1·25	1·25
Slats open (25 per cent. span)	1·3	1·25

With slats open the tip stall is entirely eliminated with flaps up (Fig. 43) and with flaps down the instability near the stall is very much reduced (Fig. 44).

The lift curves however, (Fig. 36) show that, while with flaps up the maximum lift coefficient is increased by opening the slats, with flaps down it is reduced, the smaller span slats reducing it rather less than those of larger span. It was suspected that this might be due to the flaps not extending out to the end of the slats, but measurements made with them extended by this amount showed no increase in stalling angle. The reason for this reduction in maximum lift is not very clear, and it does not occur in the few tests made with slats on the wing alone (Fig. 45).

The few measurements of elevon power made with the 40 per cent. span slats open show little change in power due to opening the slats and have therefore not been included in the results.

11. *Inboard Fins.*—11.1. *Details of Tests and Range of Investigation.*—An inboard fin was first tested in rather crude form on the wing of 36·4 deg. sweepback. The fin used for these tests was an elliptic plate with its major axis along the chord at 0·30 of the semi-span inboard from the tip. Longitudinal measurements were made with elevons 0 deg. and -10 deg. and flaps up and down. As the results were promising, a more complete set of tests was then made on the wing of 28·4 deg. sweepback.

In these tests the inboard fin effect was measured with the model in three conditions:—

- (a) Wing alone .. .
- (b) Wing and end fins } Flaps up.
- (c) Wing alone .. . Flaps down.

The six types of inboard fin tested are summarized below and shown in Fig. 34. They were all of elliptical planform, set with their major axes along the local chord. In section they were thin plates with rounded edges.

	$\frac{b^*}{a}$	$\frac{\text{Fin chord } c_f}{\text{local chord } c}$	Position inboard from tip per cent. semi-span
Fins 1 ..	0.75	1.0	0.23
Fins 2 ..	0.75	1.0	0.30
Fins 3 ..	0.75	1.0	0.37
Fins 1 ^A ..	0.5	1.0	0.23
Fins 1 ^B ..	0.25	1.0	0.23
Fins 1 ^C ..	0.75	0.7 (fin covering rear 0.7 chord)	0.23

Measurements of lift, drag and pitching moment were made with these fins to obtain the effect on longitudinal stability of:—

- (a) fin position (fins 1, 2, 3)
- (b) fin size† (fins 1, 1^A, 1^B)
- (c) fin chord/local chord ratio (fins 1, 1^C)

Lateral derivatives were measured only for the wing with optimum inboard fins.

11.2. Results.—11.21. *Longitudinal stability and trim* (Tables 17 and 18).—The pitching-moment curves on the 36.4 deg. sweepback model with inboard fins are plotted in Figs. 48 and 49. With flaps up the fins delay the longitudinal instability right up to the stall. With flaps down their effect is small but they do still cause a reduction in instability at the stall.

The results of the tests on the smaller sweepback model are analysed below.

11.211. *Fin position*.—The results for the various fin positions (fins 1, 2, 3) indicate that fins 1 (0.23 of the semi-span from the tip) give the largest increase in C_L trimmed flaps down (Fig. 47) and are nearly the best flaps up (Fig. 46).

Fig. 53 gives the elevon angle to trim with these fins and shows the improvement in the maximum C_L available with zero stability (C.G. at $0.25\bar{c}$) to be 0.25 flaps up and 0.1 flaps down.

With end fins fitted the tests were made with flaps up only and for this case fins 2 (0.30 of the semi-span from the tip) are the optimum ones (Fig. 46).

11.212. *Fin size and fin chord : local chord ratio*.—Fig. 50 shows that, for a given spanwise position of the inboard fins only the largest size of ellipse tested ($b/a = 0.75$) gives adequate stability.

Reduction of the fin chord to $c_f = 0.7c$ (fins 1^C) also leads to bad instability (Fig. 52).

On the other hand the few measurements made with half fins *i.e.* the upper surface portion only, seem to indicate that, although the half fin reduces the maximum C_L available to 0.05, the general shape of the curve remains unchanged (Fig. 51).

* $2a, 2b$, are the major and minor axes of the ellipse.

† A few measurements were also made with half fins on the upper surface only.

11.22. *Profile drag*.—The profile drag coefficients at $C_L = 0$ and 0.45 for different conditions of fins are given below. These results are obtained from Fig. 54.

TABLE I

Condition of model	$C_{D0} = \left(C_D - \frac{1}{\pi A} C_L^2 \right)$	
	$C_L = 0$	$C_L = 0.45$
Wing alone. No fins	0.0100	0.0102
Wing and end fins	0.0113	0.0104
Wing and inboard fins (fins 2) ..	0.0124	0.0133
Wing and upper half inboard fins	0.0114	0.0126

The above table shows that at $C_L = 0$ the inboard fins increase the basic drag of the wing by 24 per cent., nearly twice as much as the end fins, although the areas of the two fins are approximately equal. The drag due to the inboard fins is in fact twice the turbulent skin friction of a flat plate. At the higher C_L the comparison is even worse, as the end fins give very little increase in C_{D0} compared with the wing alone, whereas the inboard fins increase it by 30 per cent. Tufts showed a breakaway on the inboard side of the latter at the wing trailing edge which increased with incidence and this apparently causes sufficient increase in drag to nullify any decrease in induced drag.

11.23. *Lateral and Directional Stability* (Table 19).—The following table gives a comparison of the lateral derivative changes due to end fins and inboard fins.

TABLE J

	$C_L = 0.25$			$C_L = 1.0$		
	Δn_v	Δl_v	Δy_v	Δn_v	Δl_v	Δy_v
End fins	0.046	-0.046	-0.150	0.037	0.005	-0.114
Inboard fins (fins 2) ..	0.014	0.005	-0.086	0.024	0.089	-0.102

The inboard fin effect on n_v and y_v is approximately constant over the C_L range (Figs. 55 and 56). On l_v the effect is small at low C_L 's but increases with C_L tending to reduce l_v numerically (Fig. 57).

PART III

Force Measurements and Pressure Plotting Tests on a 36.4 deg. Sweepback "V" Wing (Tests made in 24-ft. Tunnel)

12. *Introduction*.—The main object of the 24-ft. tunnel tests was to provide pressure distribution measurements on a swept-back wing and so give information on the load distribution. It was also hoped that they might help to explain two unexpected results found in the tests on the smaller model in the No. 1, 11½-ft. tunnel.

- (a) Why the aerodynamic centre was found to be further aft than estimates suggested (see section 6.2), and
- (b) Why the variable-incidence tips designed to improve the longitudinal stability did not give the desired effect.

The larger sweepback angle of 36.4 deg. was chosen for the tests, since the observed effects on aerodynamic centre and instability at high lift coefficients were more marked on this wing than on the wing of smaller sweepback.

Besides the pressure measurements some force measurements were also made on the model to give direct comparison with the pressure plotting results. The results of these two series of tests are given below.

13. *Force Measurements.*—13.1. *Details of Tests.*—The scale of the model for these tests was 1/3.78 and details of it are given in Table 3 and Fig. 58.

The model differed from that used in the No. 1, 11½-ft. tunnel tests in two respects.

- (a) The variable-incidence tips were hinged on the 25 per cent. chord line instead of on the 27.5 per cent chord line.
- (b) The elevon nose was radiused and therefore compared with the "elevons sealed" condition of the previous tests.

Elevon angles for these tests were measured about the hinge line and are denoted by η_H deg. The dihedral angle was 2.9 deg.

13.2. *Range of Investigation.*—Lift, drag and pitching-moment measurements were taken over a range of incidences from 0 deg. to the stall, with variable-incidence tips set at 0 deg. (flaps 0 deg. and 60 deg., elevons 0 deg. and -10 deg.) and tips -15 deg. (flaps 0 deg. and 60 deg., elevons 0 deg. and +10 deg.). These tests were made with the chordwise gaps (roughly ¼ in. wide) between the main wing and the variable-incidence tips left unsealed. With the tips at 0 deg. the effect of sealing the gaps was investigated both with flaps 0 deg. (elevons 0 deg.) and with flaps 60 deg. (elevons -10 deg.).

The tests were made at a constant windspeed of 120 ft./sec., giving a Reynolds number of 1.55×10^6 .

13.3. *Results.*—13.31. *Chordwise gaps unsealed* (Tables 20 and 21).—The results of the tests made with the gaps unsealed are shown in Figs. 59 and 60 and the main characteristics of the model in its various conditions are summarised below. The stability with the tips deflected was very similar to that found on the smaller scale model.

TABLE K
Main Characteristics with Chordwise Gaps Unsealed

Elevons (η_H)	Tips	Flaps	C_{M0}	h_n	C_L at $\alpha = 10^\circ$	$C_{L \max}$	$C_{D \min}$	ΔC_L due to elevons	ΔC_L due to flaps
deg.	deg.	deg.							
0	0	0	0.017	0.30	0.73	1.36	0.022	—	—
0	0	60	0.062*	0.34	1.14	1.39	0.115*	—	+0.43
-10	0	0	0.113	0.34	0.60	1.29	0.027	-0.14	—
-10	0	60	0.135*	0.35	1.01	1.30	0.133*	-0.13	—
0	-15	0	0.140	0.32	0.55	1.21	0.040	—	—
0	-15	60	0.185*	0.35	1.01	1.30	0.155*	—	+0.49
+10	-15	0	0.053	0.34	0.71	1.28	0.033	+0.15	—
+10	-15	60	0.098*	0.36	1.11	1.36	0.135*	+0.12	—

* These figures were obtained by extrapolation.

N.B.—The values of h_n are measured between $C_L = 0$ and 0.75 for flaps 0 deg. and between $C_L = 0.5$ and 1.0 for flaps 60 deg.

13.32. *Effect of chordwise gaps* (Table 22).—The effect on stability of sealing or unsealing the chordwise gaps between the main wing and the variable incidence tips is shown in Figs. 61 and 62*. With flaps 0 deg. this effect is considerable, the gaps producing a stabilising effect which is comparable to that found with inboard fins on the smaller scale model. The assumption is that the passage of air through the gap between the lower and upper surfaces acts as a check to the cross flow in much the same way as an inboard fin does. With flaps 60 deg. the gaps had little effect up to the stall but caused a reduction in maximum lift coefficient of 0.04. The small effect of the gaps with flaps down explains why it was not noted during the tests on the small scale model (see Part II, section 9.2).

14. *Pressure Plotting Tests*.—14.1. *Details of Tests*.—For these tests copper tubes of inside diameter 1/16 in. were sunk into the wing flush with the surface and connected to multitube manometers. The configuration of the pressure holes at each section is given in Fig. 63 and in Tables 23, 24 and 25. Photographs were taken of the three multitube manometers with three F.24 cameras actuated simultaneously.

14.2. *Range of Investigation*.—The following table summarises the tests made. Photographs of the manometers were taken for incidences of the wing from about 0 deg. to 28 deg. at intervals of roughly 2 deg. The tests were made at a constant windspeed of 120 ft./sec., giving a Reynolds number based on the mean chord of the wing of 1.55×10^6 .

Case	Flaps	Elevons (η_H)	Variable incidence wing tips	Condition of chord- wise gaps
	deg.	deg.	deg.	
1	0	0	0	} Sealed
2	0	-10	0	
3	60	0	0	
4	60	-10	0	
5	0	0	0	
6	60	0	0	
7	0	0	-15	} Unsealed
8	0	+10	-15	
9	60	0	-15	
10	60	+10	-15	

14.3. *Presentation of Results*.—The pressures over the wing were reduced to dimensionless coefficients given by $C_p = (p - p_0)/q_0$, where p = local pressure on wing surface as given by the manometer readings, p_0 = static pressure at the plane of measurement of the undisturbed stream, and q_0 = free stream dynamic head.

Tables 26-41 give the values of C_p over the various sections of the wing for the cases:—

- | | |
|--|--|
| (1) Flaps and elevons 0 deg. | } Variable incidence tips 0 deg., and chordwise gaps sealed. |
| (2) Flaps 0 deg. and elevons -10 deg. | |
| (3) Flaps 60 deg. and elevons 0 deg. | |
| (4) Flaps 60 deg. and elevons -10 deg. | |

The other cases are not included in this report.

*The curve given in Fig. 61 of pitching moments with flaps, elevons and tips at 0 deg. and gaps unsealed was a repeat run of the curve given in Fig. 59, but the behaviour at the stall was found to have altered slightly. No reason was found for this change.

The tables are given for wing incidences from about 0 deg. to 28 deg. at intervals of roughly 4 deg., chosen by inspection of the sectional C_L against α curves.

Figs. 64 and 65 show the spanwise variation of geometric wing twist and thickness/chord ratio respectively.

The analysis of these results is not finished yet, but preliminary work gives the local lift coefficients given in Table 42 and Fig. 66, for the case of the wing with tips, elevons and flaps set at 0 deg.

15. *Conclusions.*—In these tests the chief drawback of the design was the early occurrence of a tip stall, which limited the lift range which could be used with safety.

Tip slats provided one means of delaying this stall and gave stability over the whole lift range with flaps up, and up to the stall with flaps down.

Inboard fins or a chordwise gap at 30 per cent of the span inboard from the tip had a favourable effect with flaps up but little or no effect with flaps down. Variable incidence tips were not as effective.

The importance of the elevon nose shape on elevon power was considerable.

REFERENCES

<i>Ref. No.</i>	<i>Author</i>	<i>Title, etc.</i>
1	J. Trouncer and G. F. Moss	Low Speed Model Tests on a "U" Wing. R. & M. 2295. July, 1945.
2	Falkner	The Effect of Sweepback on the Aerodynamic Loading on a "V" Wing. A.R.C. 7786. June, 1944. (Unpublished.)

APPENDIX I

List of Royal Aircraft Establishment Reports from which the Present Report is Compiled

<i>Report or Tech. Note No.</i>	<i>Authors</i>	<i>Title, etc.</i>
Report No. Aero. 1969 (A.R.C. 8180).	Trouncer, Becker and Wright.	Wind Tunnel Tests on the Stability of Tailless Gliders. Part I. "V" Wing Planforms. (September, 1944.)
Tech. Note No. Aero. 1496 (A.R.C. 8128.)	Trouncer and Wright	Wind Tunnel Tests on the Effect of Variable-incidence Tips and Tip Slats on Tailless Gliders. (August, 1944.)
Tech. Note No. Aero. 1552 (A.R.C. 8325).	Trouncer	Further Wind Tunnel Tests on the Effect of Variable-incidence Wing Tips, Tip Slats and Inboard Fins on a Tailless Glider. (November, 1944.)
Tech. Note No. Aero, 1639 (A.R.C. 8785).	Trouncer	Wind Tunnel Tests with Inboard Fins and Drag Rudders on a Tailless Glider. (May, 1945.)
Report No. Aero. 2124 (A.R.C. 9704).	Kettle	24-ft. Wind Tunnel Tests on the G.A. "V" Wing Tailless Glider. Part I. Lift, Drag and Pitching Moment Measurements. (March, 1946.)
Report No. Aero. 2147 (A.R.C. 10144).	Kettle	24-ft. Wind Tunnel Tests on the G.A. "V" Wing Tailless Glider. Part II. Pressure Distribution Measurements. (July, 1946.)
Report No. Aero. 2165 (A.R.C. 10305).	Kettle	Effect of a Chordwise Gap on the Tip Stall of a Swept-back Wing. (October, 1946.)

TABLE 4
 1/5.67 scale model
 28.4 deg. Sweepback. 0.9 deg. Dihedral
 Lift, Drag and Pitching Moment Coefficients

Condition of Model	$\eta_w = 0^\circ$				$\eta_w = -10^\circ$			
	α°	C_L	C_D	C_M	α°	C_L	C_D	C_M
Flaps 0° Wing alone. Elevons unsealed	0.35	0.038	0.0098	+0.0183				
	3.50	0.256	0.0129	0.0067				
	6.65	0.468	0.0246	-0.0045				
	9.80	0.669	0.0422	-0.0119				
	12.95	0.845	0.0628	-0.0167				
	16.05	1.008	0.0940	-0.0083				
	18.10	1.076	0.1268	+0.0040				
	21.20	1.161	0.1867	0.0209				
	23.20	1.211						
	25.20	1.224						
	27.25	1.231						
Wing alone. Elevons sealed	0.35	0.043	0.0088	+0.0168				
	3.50	0.282	0.0128	0.0034				
	6.70	0.518	0.0242	-0.0124				
	9.85	0.752	0.0423	-0.0293				
	13.05	0.960	0.0660	-0.0365				
	16.15	1.097	0.0991	-0.0183				
	18.20	1.163	0.1357	+0.0009				
	22.40	1.238						
	24.40	1.275						
	26.45	1.315						
	27.05	1.311						
Wing and fuselage. Fins off. Elevons unsealed	- 1.75	-0.090	0.0142	+0.0229	- 1.85	-0.203	0.0248	0.0816
	+ 3.50	+0.291	0.0163	-0.0001	+ 3.40	+0.164	0.0204	0.0730
	9.85	0.731	0.0477	-0.0222	9.75	0.605	0.0389	0.0476
	13.00	0.923	0.0715	-0.0315	12.90	0.820	0.0589	0.0299
	16.10	1.080	0.1039	-0.0289	16.05	0.989	0.0898	0.0152
	21.20	1.199	0.1952	+0.0020	21.15	1.108	0.1735	0.0461
Wing and fuselage. Fins on (T.B.) Elevons unsealed	- 1.75	-0.095		+0.0279	- 1.85	- 0.216	0.0257	0.0867
	- 0.70	-0.021		0.0219	+ 3.40	+ 0.154	0.0220	0.0739
	+ 0.35	+0.057	0.0134	0.0168	9.75	0.620	0.0387	0.0339
	3.55	0.299	0.0181	-0.0049	12.95	0.833	0.0606	0.0174
	6.70	0.530	0.0302	-0.0229	16.05	1.003	0.0930	0.0106
	9.85	0.748	0.0497	-0.0346	21.15	1.112	0.1755	0.0329
	13.00	0.934	0.0748	-0.0426				
	16.10	1.085	0.1062	-0.0388				
	18.15	1.138	0.1395	-0.0248				
	21.20	1.206	0.1937	-0.0041				

TABLE 4—*contd.*

Condition of Model	$\eta_w = 0^\circ$				$\eta_w = -15^\circ$			
	α°	C_L	C_D	C_M	α°	C_L	C_D	C_M
<i>Flaps 60° (with centre section flap)</i> Wing alone. Elevons scaled	- 1.40	0.408	0.116	+0.0106				
	+ 0.75	0.562	0.121	-0.0004				
	3.90	0.777	0.132	-0.0192				
	7.05	1.009	0.151	-0.0420				
	10.20	1.223	0.174	-0.0587				
	13.35	1.391	0.206	-0.0627				
	16.40	1.464	0.258	-0.0370				
	18.35	1.356						
	21.30	1.303	0.341	+0.0167				
<i>Flaps 60° (no centre section flap)</i> Wing and fuselage. Fins on (T.B.). Elevons unscaled	0.70	0.500	0.101	-0.0167	0.50	0.296	0.126	0.0999
	7.00	0.905	0.132	-0.0518	6.85	0.707	0.141	0.0610
	10.15	1.101	0.156	-0.0643	10.00	0.912	0.154	0.0423
	13.25	1.254	0.184	-0.0662	13.15	1.094	0.175	0.0230
	16.35	1.362	0.228	-0.0476	16.25	1.240	0.214	0.0194
	18.35	1.384	0.261	-0.0062	18.25	1.246	0.247	0.0323
	21.25	1.283	0.319	+0.0014	21.15	1.153	0.297	0.0562

TABLE 5

1/5.67 scale model

36.4 deg. Sweepback 1.1 deg. Dihedral

Lift, Drag and Pitching Moment Coefficients

Condition of Model	$\eta_w = 0^\circ$				$\eta_w = -10^\circ$			
	α°	C_L	C_D	C_M	α°	C_L	C_D	C_M
<i>Flaps 0°</i> Wing alone. Elevons unscaled	0.35	0.040	0.0106	+0.0208				
	3.50	0.260	0.0148	0.0069				
	6.65	0.460	0.0248	-0.0042				
	9.80	0.658	0.0402	-0.0130				
	12.95	0.857	0.0617	-0.0193				
	16.05	1.000	0.0873	+0.0022				
	18.15	1.098	0.1196	0.0215				
	21.25	1.232						
	23.30	1.323						
	25.30	1.348						
	26.30	1.345						

TABLE 5—contd.

Condition of Model	$\eta_w = 0^\circ$				$\eta_w = -10^\circ$			
	α°	C_L	C_D	C_M	α°	C_L	C_D	C_M
Flaps 0° —contd. Wing alone. Elevons sealed	- 0.75	-0.045	0.0097	+0.0252				
	+ 0.35	+0.036	0.0091	0.0187				
	3.50	0.265	0.0130	0				
	6.65	0.491	0.0230	-0.0206				
	9.85	0.712	0.0392	-0.0395				
	12.95	0.889	0.0593	-0.0315				
	16.10	1.032		-0.0020				
	18.15	1.122	0.0858	+0.0150				
	21.25	1.255	0.1477					
	23.30	1.331						
	24.30	1.350						
	25.35	1.373						
	26.35	1.362						
Wing and Fuselage. Fins off. Elevons unsealed	0.35	0.070	0.0125	+0.0177	0.25	-0.044	0.0198	0.0888
	3.50	0.276	0.0166	0.0044	3.45	+0.187	0.0205	0.0768
	6.65	0.488	0.0282	-0.0092	6.60	0.402	0.0271	0.0636
	9.80	0.690	0.0456	-0.0211	9.75	0.596	0.0376	0.0470
	12.95	0.883	0.0672	-0.0296	12.90	0.802	0.0561	0.0324
	16.10	1.027	0.0961	-0.0085	16.00	0.946	0.0820	0.0384
	18.15	1.111	0.1268	+0.0100	18.10	1.027	0.1111	0.0635
	21.25	1.239			21.15	1.143	0.1715	
	23.30	1.317			23.20	1.206		
	25.30	1.317			25.25	1.228		
	Wing and fuselage. Fins on (T.B.). Elevons unsealed	0.35	0.049	0.0140	+0.0226	0.30	-0.024	0.0212
3.50		0.279	0.0185	-0.0004	3.45	+0.198	0.0218	0.0773
6.65		0.496	0.0300	-0.0177	6.60	0.399	0.0283	0.0542
9.80		0.694	0.0468	-0.0335	9.75	0.607	0.0394	0.0348
12.95		0.890	0.0693	-0.0437	12.90	0.808	0.0581	0.0179
16.10		1.036	0.0988	-0.0195	16.00	0.959	0.0849	0.0293
18.15		1.119	0.1290	+0.0011	18.10	1.045	0.1160	0.0583
21.25		1.234			21.15	1.146		
23.30		1.310			23.20	1.205		
25.30		1.310			25.25	1.233		
Flaps 60° (with centre section flap) Wing alone. Elevons sealed		$\eta_w = 0^\circ$				$\eta_w = -15^\circ$		
	0.70	0.540	0.0992	+0.0096				
	3.85	0.745	0.1106	-0.0154				
	7.05	0.962	0.1263	-0.0425				
	10.20	1.162	0.1463	-0.0637				
	13.30	1.305	0.1730	-0.0535				
	16.40	1.439	0.2133	-0.0262				
	17.40	1.457						
	18.40	1.461						
	19.40	1.457						
Flaps 60° (no centre section flap) Wing and fuselage. Fins on (T.B.). Elevons unsealed	0.65	0.470	0.0895	+0.0023	0.50	0.283	0.1109	0.1282
	3.80	0.674	0.1011	-0.0193	3.65	0.491	0.1154	0.1045
	6.95	0.875	0.1173	-0.0417	6.85	0.697	0.1238	0.0811
	10.10	1.068	0.1386	-0.0586	10.00	0.900	0.1359	0.0597
	13.25	1.241	0.1655	-0.0580	13.10	1.085	0.1554	0.0399
	16.30	1.345	0.1988	-0.0304	16.20	1.221	0.1852	0.0532
	18.35	1.374			18.25	1.235		
	19.35	1.385	0.2593	+0.0084	19.20	1.165		
	20.35	1.379						

TABLE 6

1/5.67 scale model

28.4 deg. Sweepback

Roll, Yaw and Sideforce Coefficients

$\gamma =$ Dihedral Angle. At $\beta = 0$ deg. $C_n = C_l = C_y = 0$

Condition of Model	α°	β°	$\gamma = 0.9^\circ$			$\gamma = 2.9^\circ$			$\gamma = 5.0^\circ$			
			$10^3 C_n$	$10^3 C_l$	$10^3 C_y$	$10^3 C_n$	$10^3 C_l$	$10^3 C_y$	$10^3 C_n$	$10^3 C_l$	$10^3 C_y$	
<i>Elevons sealed</i> Wing alone. Flaps 0°	- 0.50	15	1.86	- 1.17	- 4.3	1.31	- 6.29	- 4.5	1.48	-11.41	- 7.8	
		10	1.26	- 0.11	- 2.8	0.98	- 4.23	- 2.7	1.19	- 7.83	- 4.8	
		5	0.57	- 0.04	- 1.5	0.51	- 2.31	- 1.4	0.60	- 4.15	- 2.5	
		2.5	0.29	- 0.02	- 0.8	0.29	- 0.81	- 0.5	0.28	- 1.90	- 1.1	
	3.50	15				1.44	-15.66	- 4.0				
		10				0.91	-10.77	- 2.4				
		5				0.53	- 5.54	- 1.1				
	7.75	15		4.49	-20.3	- 4.6	3.46	-25.94	- 4.6	2.90	-31.42	- 6.5
		10		3.16	-13.6	- 3.1	2.60	-17.63	- 3.2	2.24	-21.37	- 4.0
		5		1.50	- 7.08	- 1.7	1.23	- 9.23	- 1.4	0.92	-11.32	- 2.2
		2.5		0.76	- 3.39	- 0.7	0.61	- 4.76	- 0.5	0.39	- 5.63	- 1.0
	11.95	15								6.66	-42.10	- 8.4
		10				5.42	-25.41	- 4.8	5.03	-28.98	- 5.8	
		5				2.86	-13.08	- 2.3	2.48	-14.67	- 2.9	
		2.5							1.00	- 7.41	- 1.4	
	17.15	15		11.01	-38.6	- 4.8	10.38	-38.80	- 8.5	10.37	-42.27	- 9.1
		10		7.14	-28.1	- 1.7	7.02	-27.96	- 4.5	7.06	-28.12	- 6.0
		5		3.37	-14.8	+ 0.1	3.11	-14.53	- 0.6	3.27	-14.39	- 2.0
		2.5		1.56	- 7.5	0.4	1.57	- 7.52	- 0.2	1.64	- 7.47	- 0.7
	Wing alone. Flaps 60° (with centre section flap).	- 0.15	15	4.05	-13.3	-11.3	3.44	-18.81	-12.8	3.21	-24.22	-16.7
10			2.68	- 9.18	- 7.8	2.25	-12.61	- 8.7	1.96	-16.58	-11.5	
5			1.19	- 4.03	- 3.8	1.13	- 6.61	- 4.3	0.78	- 8.84	- 5.4	
2.5			0.55		- 2.0	0.46	- 3.43	- 2.1	0.33	- 4.44	- 2.6	
3.90		10				3.34	-19.37	- 9.4				
		5				1.54	-10.26	- 4.5				
10.20		15				10.87	-43.46	-17.2	9.34	-48.23	-20.4	
		10				7.46	-29.98	-11.5	6.57	-33.12	-13.8	
		5				3.66	-15.39	- 5.6	3.41	-17.02	- 6.6	
		2.5				1.54	- 7.78	- 3.0	1.45	- 8.50	- 3.3	
16.40		15		16.8	-49.8	-11.9	16.05	-49.29	-18.3	15.72	-46.4	-24.6
		10		11.8	-26.0	-13.5	12.58	-23.21	-19.1	10.87	-20.8	-20.8
		5		6.3	- 8.01	-11.2	5.93	- 7.13	-10.2	5.82	- 4.75	-13.5
		2.5		3.4	- 3.99	- 6.4	3.24	- 2.34	- 7.3	2.73	- 2.61	- 7.0

TABLE 6—continued

Condition of Model	α°	β°	$\gamma = 0.9^\circ$			$\gamma = 2.9^\circ$			$\gamma = 5.0^\circ$		
			$10^3 C_n$	$10^3 C_l$	$10^3 C_y$	$10^3 C_n$	$10^3 C_l$	$10^3 C_y$	$10^3 C_n$	$10^3 C_l$	$10^3 C_y$
Wing and fuselage. Flaps 0° .	- 0.50	15	- 0.88		-17.0	- 1.06	- 3.00	-14.2			
		10	- 0.66		-10.5	- 0.64	- 2.04	- 8.9			
		5	- 0.38		- 5.0	- 0.31	- 1.02	- 4.6			
		2.5	- 0.18		- 2.6	- 0.21	- 0.60	- 2.2			
	7.80	10				0.97	-15.36	- 9.4			
		5				0.49	- 8.25	- 5.4			
	9.90	15				2.87	-26.93	-19.2			
		10				2.30	-18.58	-12.3			
		5				1.25	- 9.62	- 6.5			
		2.5				0.62	- 5.12	- 3.2			
	17.20	15				7.82	-34.30	-24.6			
		10				6.13	-31.41	- 8.6			
5					3.80	-19.41	- 1.5				
2.5					1.96	-10.79	+ 0.6				
<i>Elevons unsealed</i> Wing alone. Flaps 0° . $\eta_w = 0^\circ$.	0.50	15	1.55	0.38	- 1.7						
		10	1.18	0.63	- 1.7				1.16	- 6.71	- 4.8
		5	0.52	0.49	- 0.7				0.55	- 3.37	- 2.3
		2.5	0.25	0.28	- 0.4						
	7.70	10							2.17	-19.61	- 4.7
		5							1.10	- 9.93	- 2.3
	11.90	15							6.26	-34.57	- 9.6
		10							4.46	-23.78	- 6.6
		5							2.20	-12.19	- 3.2
		2.5							1.16	- 6.27	- 1.3
	15.00	10								-27.42	- 6.0
		5								-13.92	- 3.3
17.10	15		10.88	-33.13	- 5.7						
	10		7.65	-24.28	- 3.0						
	5		3.82	-13.22	- 1.1						
	2.5		1.90	- 6.95	- 0.5						
$\eta_w = 10^\circ$.	11.80	15							5.40	-26.91	- 8.2
		10							3.80	-18.73	- 5.3
		5							2.07	- 9.14	- 2.5
		2.5							1.07	- 4.75	- 0.6
Wing and fuselage. Flaps 0° .	- 0.50	15	- 1.19	3.23	-14.5						
		10	- 0.85	2.41	- 8.7						
		5	- 0.43	1.41	- 4.4						
		2.5	- 0.20	0.75	- 2.3						
	17.25	15	7.92	-29.96	-24.2						
		10	5.99	-27.17	- 9.9						
		5	3.46	-15.84	- 2.7						
		2.5	1.91	- 8.22	- 1.8						

TABLE 6—continued

Condition of Model	α°	β°	$\gamma = 0.9^\circ$			$\gamma = 2.9^\circ$			$\gamma = 5.0^\circ$		
			10^3C_n	10^3C_l	10^3C_γ	10^3C_n	10^3C_l	10^3C_γ	10^3C_n	10^3C_l	10^3C_γ
<i>Elevons unsealed</i> Wing and fuselage. Flaps 60°. (No centre section flap.)	16.30	12.93	-38.80	-24.6							
		8.71	-26.90	-16.3							
		4.65	-10.46	-11.0							
		2.21	-6.47	-6.1							
Wing alone with large fins (T.B.). Flaps 0°.	-0.50	10						10.96	-13.32	-59.2	
		5						5.73	-6.92	-30.7	
	3.50	10						9.89			
		5						4.99			
	7.70	10						10.18	-22.67	-49.9	
5							4.95	-11.79	-25.5		
11.90	10						12.04	-25.05	-46.8		
	5						5.82	-12.99	-23.1		
15.00	10							-29.17	-4.78		
	5							-14.04	-2.34		
Wing and fuselage with large fins (T.B.). Flaps 0°.	-0.50	15	12.10	-4.95	-87.5						
		10	9.03	-3.35	-60.8						
		5	4.70	-1.45	-31.1						
		2.5	2.38	-1.17	-16.2						
	7.75	15	15.14	-16.91	-74.6						
		10	9.19	-13.50	-55.6						
		5	4.57	-6.60	-27.9						
		2.5	2.31	-3.49	-14.2						
	17.15	15	21.88	-31.66	-81.8						
		10	14.40	-29.83	-54.0						
5		7.60	-15.94	-26.5							
2.5		3.92	-7.71	-13.5							
Wing and fuselage with large top fin (T). Flaps 0°.	-0.50	15	8.38	-13.17	-76.2						
		10	7.92	-8.25	-54.0						
		5	4.23	-3.42	-28.1						
		2.5	2.16	-2.25	-14.8						
	17.15	15	19.56	-32.53	-71.3						
		10	13.14	-30.52	-47.8						
5	6.96	-16.34	-23.6								
	2.5	3.71	-8.34	-11.8							
	Wing and fuselage with small top fin (t). Flaps 0°.	-0.50	15	4.46	-4.31	-44.0					
			10	3.07	-2.89	-28.9					
5			1.55	-1.86	-14.6						
2.5			0.78	-0.48	-7.3						
17.15	15	13.91	-30.76	-56.6							
	10	9.99	-28.34	-29.6							
	5	5.49	-15.88	-14.4							
	2.5	2.81	-8.13	-6.8							

TABLE 6—continued

Condition of Model	α°	β°	$\gamma = 0.9^\circ$		
			$10^3 C_n$	$10^3 C_l$	$10^3 C_y$
<i>Elevons unsealed</i> Wing and fuselage with large fins (T.B.). Flaps 60° (No centre section flap).	- 0.15	15	13.46	-14.97	-83.0
		10	8.79	-11.93	-58.2
		5	4.28	- 6.19	-29.7
		2.5	2.29	- 3.22	-14.9
	10.10	15	19.92	-27.25	-71.1
		10	12.71	-20.00	-53.0
		5	6.33	-10.00	-25.1
		2.5	3.17	- 4.69	-12.3
	16.30	15	26.30	-41.56	-82.9
		10	17.01	-30.54	-58.1
		5	8.70	-12.89	-30.6
		2.5	4.54	- 5.69	-15.3

TABLE 7

1/5·67 scale model

36·4 deg. Sweepback

Roll, Yaw and Sideforce Coefficients

 $\gamma =$ Dihedral Angle. At $\beta = 0$ deg. $C_l = C_n = C_\gamma = 0$

Condition of Model	α°	β°	$\gamma = 1\cdot1^\circ*$			$\gamma = 5\cdot0^\circ$		
			10^3C_n	10^3C_l	10^3C_γ	10^3C_n	10^3C_l	10^3C_γ
<i>Elevons sealed</i> Wing alone. Flaps 0° .	- 0·20	15	0·73	- 1·62	- 5·5	0·56	-12·1	-11·7
		10	0·55	- 1·18	- 3·3	0·63	- 7·9	- 7·5
		5	0·24	- 1·04	- 1·5	0·42	- 4·6	- 4·2
	4·05	5	0·68	- 5·21	- 1·5	0·24	- 9·0	- 3·6
	8·25	5	1·82	-10·02	- 2·1	1·35	-13·7	- 3·8
	11·40	15	7·85	-41·0	- 7·2	6·26	-50·6	-10·6
		10	5·75	-28·6	- 5·1	4·36	-34·5	- 7·8
		5	3·03	-14·5	- 2·5	2·14	-17·3	- 4·0
	13·25	5	3·56	-18·7	- 1·3			
	15·35	15	8·46	-49·7	0·1	8·79	-52·1	- 9·4
		10	5·68	-35·4	0·9	5·52	-36·5	- 4·7
		5	2·80	-18·6	1·4	2·26	-19·1	- 1·5
Wing alone. Flaps 60° (with centre section flap).	0·20	15	3·02	-19·3	-12·9			
		10	1·95	-13·5	- 8·3			
		5	1·08	- 7·0	- 4·1			
	4·65	5	2·05	-11·6				
	7·65	5	3·15	-14·6	- 5·1			
11·00	15	13·05	-53·4	-15·9				
	10	8·87	-38·3	-10·5				
	5	4·81	-19·9	- 4·4				
13·10	5	4·67	-22·4	- 3·3				
<i>Elevons unsealed</i> Wing alone. Flaps 0° .	- 0·20	15	0·52	+ 0·08	- 5·4			
		10	0·40	0·47	- 3·4			
		5	0·14	- 0·05	- 1·5			
	4·30	5	0·57	- 4·66	- 1·7			
	8·95	5	2·06	- 8·59	- 3·0			
	12·10	15	8·48	-33·4	- 9·8			
		10	6·43	-23·2	- 7·7			
		5	3·30	-11·9	- 4·0			

TABLE 7—(continued)

Condition of Model	α°	β°	$\gamma = 1.1^\circ*$			
			10^3C_n	10^3C_l	10^3C_y	
<i>Elevons unsealed</i> Wing and fuselage. Flaps 0° .	- 0.70	15	- 2.15	3.81	-18.75	
		10	- 1.36	3.02	-11.43	
		5	- 0.65	1.97	- 5.60	
	3.95	5	- 0.38	- 3.27	- 5.9	
	8.50	5	+ 0.73	- 7.07	- 8.1	
	11.60	15	4.84	-27.9	-27.8	
		10	4.06	-19.4	-18.7	
		5	1.98	- 9.7	- 9.2	
	Wing and fuselage with large fins (T.B.). Flaps 0° .	- 0.50	15	15.70	- 3.16	-93.4
			10	11.33	- 2.33	-63.4
			5	6.07	- 0.72	-32.2
		3.95	5	5.46	- 5.68	-31.9
8.45		5	5.72	- 7.56	-29.57	
11.60		15	21.27	-26.08	-83.0	
		10	13.60	-19.38	-58.5	
		5	6.62	- 9.67	-28.8	
Wing and fuselage with large fins (T.B.). Flaps 60° (No centre section flap).		1.10	15	17.17	-19.3	-92.8
			10	11.35	-15.0	-66.3
			5	5.83	- 7.6	-33.1
		5.90	5	6.08	-10.39	-31.1
	9.05	5	7.11	-11.4	-30.1	
	12.60	15	27.51	-43.3	-89.6	
		10	18.13	-32.6	-64.5	
		5	8.40	-16.6	-32.4	

* To simplify comparison between the two sweepback angles the curves given in Figs. 10, 11 and 13 have been corrected to a dihedral angle of 0.9 deg. This 0.2 deg. decrease in dihedral will have a negligible effect on n_x and y_x but will decrease l_x numerically by 0.002 .

TABLE 8
 1/5·67 scale model
 28·4 deg. Sweepback. $\gamma =$ Dihedral angle
 Lateral Derivatives

Condition of model	α°	C_L	$\gamma = 0\cdot9$			$\gamma = 2\cdot9$			$\gamma = 5\cdot0$		
			n_v	l_v	y_v	n_v	l_v	y_v	n_v	l_v	y_v
<i>Elevons sealed</i> Wing alone. Flaps 0°	- 0·50	-0·02	0·007	0	-0·009	0·006	-0·026	-0·008	0·007	-0·045	-0·014
	+ 3·50	+0·28				0·006	-0·059	-0·006			
	7·75	0·60	0·017	-0·078	-0·009	0·014	-0·101	-0·008	0·011	-0·130	-0·012
	11·95	0·90				0·033	-0·148	-0·013	0·029	-0·170	-0·017
	17·15	1·13	0·040	-0·170	+0·003	0·036	-0·163	-0·013	0·038	-0·165	-0·014
Wing alone. Flaps 60° (with centre section flap)	- 0·15	0·50	0·014	-0·051	-0·022	0·013	-0·074	-0·025	0·007	-0·101	-0·032
	+ 3·90	0·78				0·019	-0·111	-0·026			
	10·20	1·22				0·043	-0·175	-0·033	0·039	-0·195	-0·038
	16·40	1·46	0·070	-0·092	-0·064	0·072	-0·082	-0·058	0·062	-0·054	-0·079
Wing and fuselage. Flaps 0°	- 0·50	0	-0·004		-0·030	-0·004	-0·012	-0·026			
	+ 7·80	0·65				+0·006	-0·091	-0·032			
	9·90	0·81				0·014	-0·110	-0·038			
	17·20	1·20				0·045	-0·235	-0·009			
<i>Elevons unsealed</i> Wing alone. Flaps 0° $\eta_w = 0^\circ$	- 0·50	-0·02	0·006	+0·006	-0·005				0·007	-0·039	-0·013
	+ 7·70	+0·54							0·013	-0·113	-0·013
	11·90	0·79							0·026	-0·140	-0·018
	15·00	0·95								-0·159	-0·019
	17·10	1·04	0·044	-0·151	-0·006						
$\eta_w = 10^\circ$	11·80	0·68						0·024	-0·105	-0·015	
Wing and fuselage. Flaps 0°	- 0·50	0	-0·005	+0·016	-0·025						
	+17·15	1·11	+0·042	-0·185	-0·021						

TABLE 8—continued

Condition of model	α°	C_L	$\gamma = 0.9$			$\gamma = 2.9$			$\gamma = 5.0$		
			n_v	l_v	y_v	n_v	l_v	y_v	n_v	l_v	y_v
<i>Elevons unsealed</i>											
Wing and fuselage. Flaps 60° (no centre section flap)	16.30	1.34	0.050	-0.148	-0.055						
Wing alone with large fins (T.B.). Flaps 0°	- 0.50 + 3.50 7.70 11.90 15.00	-0.02 +0.26 0.54 0.79 0.95							0.065 0.057 0.057 0.068	-0.076 -0.135 -0.147 -0.164	-0.173 -0.145 -0.134 -0.136
Wing and fuselage with large fins (T.B.). Flaps 0°	- 0.50 + 7.75 17.15	0 0.60 1.11	0.054 0.054 0.087	-0.019 -0.076 -0.177	-0.178 -0.159 -0.155						
Wing and fuselage with large top fin. (T). Flaps 0°	- 0.50 +17.15	0 1.11	0.049 0.077	-0.043 -0.187	-0.161 -0.136						
Wing and fuselage with small top fin (t). Flaps 0°	- 0.50 +17.15	0 1.11	0.018 0.064	-0.017 -0.182	-0.084 -0.084						
Wing and fuselage with large fins (T.B.). Flaps 60° (no centre section flap)	- 0.15 +10.10 16.30	0.46 1.10 1.36	0.051 0.073 0.100	-0.072 -0.115 -0.130	-0.170 -0.144 -0.175						

TABLE 9
 1/5·67 scale model
 36·4 deg. Sweepback
 Lateral Derivatives

Condition of model	α°	C_L	$\gamma = 1\cdot1^\circ$			$\gamma = 5\cdot0^\circ$		
			n_v	l_v	y_v	n_v	l_v	y_v
<i>Elevons sealed</i> Wing alone. Flaps 0°.	- 0·20	0	0·003	-0·012	-0·008	0·005	-0·052	-0·024
	+ 4·05	0·3	0·008	-0·060	-0·009	0·003	-0·103	-0·021
	8·25	0·6	0·021	-0·114	-0·012	0·015	-0·156	-0·022
	11·40	0·8	0·035	-0·166	-0·014	0·025	-0·197	-0·023
	13·25	0·9	0·041	-0·214	-0·007			
	15·35	1·0	0·032	-0·213	+0·008	0·026	-0·219	-0·009
Wing alone. Flaps 60° (with centre section flap).	0·20	0·5	0·012	-0·080	-0·023			
	4·65	0·8	0·023	-0·133				
	7·65	1·0	0·036	-0·167	-0·029			
	11·00	1·2	0·055	-0·227	-0·025			
	13·10	1·3	0·054	-0·257	-0·019			
<i>Elevons unsealed</i> Wing alone. Flaps 0°.	- 0·20	0	0·002	-0·001	-0·008			
	+ 4·30	0·3	0·007	-0·053	-0·010			
	8·95	0·6	0·024	-0·098	-0·017			
	12·10	0·8	0·038	-0·136	-0·023			
Wing and fuselage. Flaps 0°.	- 0·70	0	-0·007	+0·022	-0·032			
	+ 3·95	0·3	-0·004	-0·037	-0·034			
	8·50	0·6	+0·008	-0·081	-0·046			
	11·60	0·8	0·023	-0·111	-0·052			
Wing and fuselage with large fins (T.B.). Flaps 0°.	- 0·50	0	0·070	-0·008	-0·184			
	+ 3·95	0·3	0·063	-0·065	-0·183			
	8·45	0·6	0·066	-0·087	-0·169			
	11·60	0·8	0·076	-0·111	-0·165			
Wing and fuselage with large fins (T.B.). Flaps 60° (no centre section flap).	1·10	0·5	0·067	-0·086	-0·190			
	5·90	0·8	0·070	-0·119	-0·178			
	9·05	1·0	0·081	-0·131	-0·172			
	12·60	1·2	0·096	-0·190	-0·186			

TABLE 10
1/5·67 scale model
28·4 deg. Sweepback
Elevon power

Condition of model	α°	C_L^*	η_w°	ΔC_M port and starboard elevons	$10^3 \Delta C_n$	$10^3 \Delta C_l$	$10^3 \Delta C_y$
					starboard elevon only		
<i>Elevons unsealed</i> Wing and fuselage. Flaps 0°.	3·50	0·29	-25	+0·1696	5·92	+42·16	-7·8
			-20	0·1240	4·52	32·66	-5·0
			-15	0·0930	2·65	22·94	-3·4
			+15	-0·0954	3·97	-24·11	-1·9
	16·10	1·08	-25	+0·1412	-0·22	+36·80	-13·1
			-20	0·1036	-1·48	26·28	-7·8
-15			0·0706	-2·06	17·52	-4·6	
+15			-0·0770	+5·26	-20·52	+3·6	
Wing and fuselage with large fins (T.B.). Flaps 0°.	3·55	0·30	-25	+0·1802	3·91	+45·87	+3·4
			-20	0·1386	3·06	34·41	5·1
			-15	0·1154	1·47	26·23	6·3
			+15	-0·0894	4·24	-23·56	-6·5
	16·10	1·09	-25	+0·1344	-1·10	+33·39	-11·3
			-20	0·0982	-1·93	25·17	-9·1
-15			0·0746	-2·11	18·47	-4·4	
+15			-0·0776	+5·18	-20·67	+1·4	
Wing and fuselage with large fins (T.B.). Flaps 60° (no centre section flap).	16·30	1·36	-25	+0·1280	-1·01	+38·15	-20·1
			-20	0·1200	-1·76	30·04	-16·4
			-15	0·0722	-0·44	21·56	-6·1
			+15	-0·0660	+4·04	-17·64	+8·2
<i>Elevons sealed</i> Wing alone. Flaps 0°.	3·30	0·32	-25	+0·2038	6·57	+95·8	-9·25
			-15	0·1484	2·39	39·6	-4·2
			+15	-0·1280	3·73	-32·1	-1·35
	11·55	0·90	-25	+0·2122	+3·32	+57·5	-18·6
			-15	0·1492	-0·20	39·0	-10·2
			+15	-0·1092	+5·36	-27·4	+3·5
	15·70	1·10	-25	+0·1594	+0·07	+47·1	-16·85
			-15	0·1010	-2·24	28·1	-8·55
			+15	-0·1106	+5·65	-22·7	+3·65
Wing alone. Flaps 60° (with centre section flap).	0·85	0·61	-25	+0·2100	9·70	+54·6	-8·4
			-15	0·1566	3·92	38·8	-3·6
			+15	-0·1420	2·61	-35·5	-1·6
	8·20	1·12	-25	+0·2070	5·32	+58·5	-17·25
			-15	0·1564	1·39	40·2	-8·7
			+15	-0·1048	4·17	-26·1	+1·75
	12·40	1·38	-25	+0·2128	+3·09	+58·5	-19·45
			-15	0·1360	-0·58	36·7	-9·4
			+15	-0·0864	+4·87	-19·9	+0·65

* The C_L given is the C_L at $\eta_w = 0$ deg.

TABLE 11
 1/5·67 scale model
 36·4 deg. Sweepback
 Elevon power

Condition of model	α°	C_L^*	η_w°	ΔC_M port and starboard elevons	$10^3 \Delta C_n$	$10^3 \Delta C_l$ starboard	$10^3 \Delta C_y$ elevon only	ΔC_L
<i>Elevons unsealed</i> Wing alone. Flaps 0°.	- 0·20	0	-25	+0·1596	4·90	+33·98	-0·18	-0·120
			-20	0·1258	3·80	27·00	+1·03	-0·098
			-15	0·1004	2·09	21·28	1·66	-0·071
			-10	0·0652	1·19	13·78	1·29	-0·051
			+10	-0·0696	1·40	-14·42	-5·98	+0·041
			15	-0·1084	3·14	-24·32	-9·24	0·145
	8·95	0·6	-25	+0·1698	+2·64	+34·98	-6·12	-0·115
			-20	0·1364	2·15	27·28	-6·39	-0·089
			-15	0·1068	0·37	20·38	-1·31	-0·082
			-10	0·0702	-0·90	13·68	+0·18	-0·045
			+10	-0·0684	+2·47	-14·82	-2·24	+0·044
			15	-0·1024	4·15	-22·82	-4·10	0·071
	12·10	0·8	-25	+0·1602	+2·08	+33·24	-2·80	-0·118
			-20	0·1318	0·36	26·64	-4·42	-0·087
			-15	0·0944	-0·88	18·94	-1·99	-0·077
-10			0·0584	-1·37	11·74	-0·62	-0·048	
+10			-0·0614	+2·41	-13·46	-0·65	-0·038	
15			-0·0910	4·49	-20·76	-2·59	+0·064	
Wing alone. Flaps 60° (with centre section flap).	0·20	0·5	-25	+0·1876	6·36	+36·64	-2·36	-0·13
			-15	0·1176	2·67	23·64	+0·76	-0·10
			+15	-0·1142	2·44	-25·16	-8·38	+0·07
	7·65	1·0	-25	+0·2018	4·37	+40·44	-7·31	-0·17
			-15	0·1264	1·07	23·74	-1·34	-0·11
			+15	-0·0946	4·37	-20·76	-3·45	+0·08

* The C_L given is the C_L at $\eta_w = 0$ deg.

TABLE 12A
 1/5.67 scale model
 28.4 deg. Sweepback
 Rudder Power from Conventional Rudders

Condition of model	α°	C_L	ζ°	$10^3 \Delta C_n$ Port rudder only
<i>Elevons unsealed. Flaps 0°</i> Wing and fuselage with large top fin (T).	-0.50	0	10	- 4.48
			20	- 9.50
			25	-10.84
			30	-12.54
Wing and fuselage with small top fin (t).	-0.50	0	10	- 2.51
			20	- 4.57
			25	- 5.22
			30	- 6.04

TABLE 12B
 1/5.67 scale model
 28.4 deg. Sweepback
 Rudder Power from Drag Rudders

Drag rudder No.*	α°	C_L^{**}	ΔC_L	ΔC_D	ΔC_M	$10^3 \Delta C_n$	$10^3 \Delta C_l$	$10^3 \Delta C_y$
Due to rudders on port side only								
<i>Wing alone. Flaps 0°. Elevons sealed. $\eta_w = 0^\circ$</i>								
1 (A)	0.1	-0.011	-0.008	0.0130	-0.0036	- 6.84	+0.86	8.76
	6.45	+0.466	-0.007	0.0131	-0.0001	- 7.25	0.01	8.24
	12.8	0.908	-0.004	0.0141	-0.0018	- 7.32	-0.52	9.79
1 (B)	6.45	0.466		0.0142		- 6.43		1.34
2 (A)	0.1	-0.011	-0.013	0.0172	-0.0039	- 8.56	+1.74	10.56
	6.45	+0.466	-0.018	0.0175	+0.0082	- 8.46	-4.40	9.90
	12.8	0.908	-0.010	0.0162	0.0130	- 7.87	- 8.64	11.39
2 (B)	6.45	0.466		0.0246		-10.88		5.49

* For details of drag rudders see Table 3 and Fig. 3.

** The C_L given is the C_L wing alone, no rudders.

TABLE 13

1/5·67 scale model

28·4 deg. Sweepback

Elevon Power Behind Drag Rudders

Rudders were No. 2(A) i.e. spoiler type hinged along the 60 per cent. chord line.

Condition of model	α°	C_L^*	η_w°	ΔC_L	ΔC_M
				starboard elevon only	
<i>Wing alone. Flaps 0°. Elevons sealed</i> No rudders.	0·75	0·05	+10	+0·111	-0·0490
			-10	-0·064	+0·0398
	7·7	0·57	+10	+0·073	-0·0393
			-10	-0·086	+0·0483
	14·0	0·975	+10	+0·067	-0·0321
			-10	-0·062	+0·0397
With rudders 2 (A)	0·75	0·06	+10	+0·054	-0·0220
			-10	-0·055	+0·0228
	7·7	0·55	+10	+0·059	-0·0230
			-10	-0·052	+0·0229
	14·0	0·96	+10	+0·047	-0·0213
			-10	-0·041	+0·0218

* The C_L given is the C_L at $\eta_w = 0$ deg.

TABLE 14

1/5·67 scale model

28·4 deg. Sweepback

Tests with Variable-incidence Wing Tips, Elevons Sealed—Lift, Drag and Pitching-Moment Coefficients

Condition of model	α°	C_L	C_D	C_M
<i>Tips 0° relative to wing (Gaps sealed)</i>				
Wing alone. Flaps 0°. $\eta_w = 0^\circ$	- 0·65	0·006	0·0105	+0·0239
	+ 0·45	0·079	0·0104	0·0201
	3·60	0·325	0·0161	0·0033
	6·80	0·565	0·0296	-0·0115
	9·95	0·797	0·0494	-0·0277
	13·10	0·995	0·0733	-0·0330
	16·20	1·117	0·1130	-0·0107
	19·30	1·206	0·1756	+0·0106
	22·30	1·244	0·2415	0·0183
	24·35	1·296	0·2973	0·0162
	26·40	1·338	0·3656	-0·0009
	27·40	1·338		

TABLE 14—continued

Condition of model	α°	C_L	C_D	C_M
<i>Tips 0° relative to wing (Gaps sealed)—contd.</i>				
Wing alone. Flaps 0° $\eta_w = -10^\circ$.	0.85	-0.046	0.0168	0.1087
	3.50	+0.152	0.0176	0.1010
	6.65	0.383	0.0250	0.0834
	9.85	0.623	0.0392	0.0629
	13.00	0.849	0.0609	0.0430
	16.15	1.011	0.0933	0.0396
	19.20	1.097	0.149	0.0607
	22.25	1.148		
	24.30	1.205		
	26.30	1.251		
	27.30	1.249		
Wing and fins. Flaps 60°. (with centre section flap). $\eta_w = -10^\circ$.	0.70	0.452	0.1448	0.0990
	3.85	0.646	0.1515	0.0790
	7.05	0.869	0.1646	0.0531
	10.20	1.075	0.1841	0.0315
	13.35	1.295	0.2155	0.0046
	14.90	1.363	0.2439	0.0027
	16.45	1.432	0.2699	0.0060
	17.35	1.329	0.2858	0.0173
<i>Tips -10° relative to wing (Gaps unsealed)</i>				
Wing alone. Flaps 0°. $\eta_w = 0^\circ$.	0.40	0.020	0.0185	0.0673
	3.55	0.244	0.0214	0.0552
	6.75	0.472	0.0315	0.0432
	9.90	0.697	0.0497	0.0311
	13.05	0.891	0.0751	0.0230
	16.15	1.054	0.1039	0.0227
	19.25	1.143	0.1580	0.0391
	22.25	1.185	0.2162	0.0383
	24.30	1.235	0.2530	0.0303
	26.30	1.263	0.2899	0.0196
	28.30	1.238	0.3646	0.0205
<i>Tips -10° relative to wing (Gaps unsealed)</i>				
Wing alone. Flaps 0°. $\eta_w = -10^\circ$.	1.85	-0.058	0.0294	0.1554
	3.40	+0.057	0.0286	0.1495
	6.60	0.290	0.0328	0.1349
	9.75	0.520	0.0445	0.1216
	12.90	0.734	0.0642	0.1075
	16.05	0.916	0.0945	0.0946
	19.15	1.010	0.1404	0.1000
	22.20	1.072	0.1933	0.0966
	24.20	1.101		
	26.20	1.126		
	27.25	1.144		
Wing and fins. Flaps 60°. (with centre section flap). $\eta_w = 0^\circ$.	0.75	0.494	0.1396	+0.0610
	3.90	0.718	0.1508	0.0399
	7.10	0.954	0.1684	0.0149
	10.25	1.157	0.1932	-0.0073
	13.35	1.330	0.2282	-0.0137
	14.95	1.404	0.2481	-0.0177
	16.35	1.330	0.2720	-0.0002
	17.30	1.239	0.2849	+0.0157

TABLE 14—continued

Condition of Model	α°	C_L	C_D	C_M
<i>Tips -10° relative to wing (Gaps sealed)</i>				
Wing alone. Flaps 60° (with centre section flap). $\eta_w = 0^\circ$.	0.75	0.516	0.1350	+0.0531
	3.90	0.734	0.1471	0.0341
	7.10	0.955	0.1639	0.0169
	10.25	1.158	0.1860	-0.0005
	13.40	1.345	0.2145	-0.0117
	14.90	1.385	0.2381	-0.0042
	16.35	1.298	0.2693	+0.0172
Wing and fins. Flaps 0° . $\eta_w = 0^\circ$.	0.35	-0.010	0.0212	+0.0776
	6.75	+0.476	0.0316	0.0387
	13.05	0.930	0.0690	-0.0012
	16.20	1.081	0.1081	+0.0065
	19.25	1.174	0.1610	0.0249
	22.30	1.225	0.2390	0.0227
	24.35	1.288	0.2769	0.0178
	26.40	1.338	0.3591	0.0024
	27.35	1.316	0.3820	-0.0003
Wing and fins. Flaps 60° (with centre section flap). $\eta_w = 0^\circ$	0.75	0.520		+0.0576
	3.95	0.750	0.1490	0.0334
	10.25	1.171	0.1932	-0.0184
	13.40	1.365	0.2151	-0.0311
	14.95	1.411	0.2453	-0.0209
	16.35	1.325	0.2692	+0.0002
<i>Tips -5° relative to wing (Gaps sealed)</i>				
Wing alone. Flaps 0° . $\eta_w = 0^\circ$.	0.40	0.052	0.0127	+0.0384
	6.75	0.534	0.0290	0.0075
	13.10	0.956	0.0701	-0.0151
	16.20	1.089	0.1092	-0.0017
	19.25	1.174	0.1678	+0.0183
	22.30	1.227	0.2294	0.0215
	24.35	1.282	0.2812	0.0188
	26.35	1.320	0.3624	-0.0036
Wing alone. Flaps 60° . (with centre section flap). $\eta_w = 0^\circ$.	10.30	1.210	0.1856	-0.0353
	13.40	1.384	0.2167	-0.0399
	14.40	1.390	0.2363	-0.0330
	14.90	1.395	0.2427	-0.0261
	16.35	1.300	0.2661	-0.0038

TABLE 15

1/5·67 scale model

36·4 deg. Sweepback

*Tests with Variable-incidence Wing Tips (Gaps Unsealed), Wing Alone, Elevons Unsealed—Lift, Drag and Pitching-Moment Coefficients**

Condition of model	$\eta_w = 0^\circ$			$\eta_w = +15^\circ$		
	α°	C_L	C_M	α°	C_L	C_M
Flaps 0° Tips -15°				3·50	0·239	+0·0235
				6·65	0·466	0·0065
				12·95	0·858	-0·0189
				16·10	1·013	-0·0098
				19·20	1·162	0
				23·30	1·297	+0·0142
				25·30	1·324	0·0171
Tips -20°	3·35	0·043	0·1706	3·15	0·212	0·0605
	6·50	0·232	0·1572	6·60	0·427	0·0466
	12·80	0·651	0·1350	12·95	0·828	0·0189
	15·90	0·821	0·1267	16·05	1·002	0·0200
	19·05	0·973	0·1299	19·15	1·140	0·0334
	23·20	1·167	0·1355	23·25	1·268	0·0493
	25·20	1·195	0·1360	25·30	1·295	0·0668
	26·20	1·198		26·30	1·306	
27·20	1·209	0·1367	27·30	1·316		
Flaps 60° (with centre section flap) Tips -15°				3·85	0·712	+0·0224
				7·00	0·915	0·0022
				10·10	1·085	-0·0059
				13·20	1·224	+0·0040
				16·30	1·343	0·0142
				18·35	1·393	0·0307
				19·35	1·371	0·0409
Tips -20°	3·65	0·493	0·1806	3·80	0·668	0·0642
	6·80	0·685	0·1667	6·95	0·868	0·0437
	9·95	0·883	0·1454	10·10	1·058	0·0295
	13·10	1·074	0·1275	13·20	1·195	0·0373
	16·20	1·210	0·1265	16·30	1·321	0·0461
	17·25	1·248	0·1293	17·30	1·337	0·0551
	18·25	1·266	0·1389	18·30	1·357	0·0638
	19·20	1·173	0·1512	19·30	1·334	0·0709

* The basic cases with tips 0 deg. are identical with the "no fin" results of Table 18.

TABLE 16

1/5·67 scale model

36·4 deg. Sweepback

Tests With Tip Slats, Elevons Unsealed—Lift, Drag and Pitching-Moment Coefficients*

Condition of model	α°	C_L	C_D	C_M	
With tip slats of 40 per cent. span Complete model. Flaps 0° . $\eta_w = 0^\circ$.	0·40	0·133	0·0233	+0·0140	
	3·55	0·328	0·0304	0·0103	
	6·70	0·552	0·0412	-0·0112	
	9·90	0·762	0·0589	-0·0318	
	13·00	0·958	0·0827	-0·0459	
	16·15	1·142	0·1168	-0·0636	
	19·30	1·303	0·1833	-0·0857	
	22·35	1·420	0·2576	-0·1036	
	24·40	1·467	0·3035	-0·1135	
	26·45	1·491	0·3493	-0·1257	
27·40	1·474	0·3743	-0·1409		
$\eta_w = -10^\circ$.	12·95	0·868	0·0714	+0·0126	
	16·10	1·044	0·1017	-0·0004	
	19·20	1·173	0·1591	-0·0126	
	22·30	1·310	0·2260	-0·0291	
	24·30	1·353	0·2675	-0·0359	
	26·35	1·391	0·3079	-0·0493	
	27·35	1·372	0·3309	-0·0573	
Complete model. Flaps 60° . (with centre section flap). $\eta_w = 0^\circ$.	2·20	0·562	0·1092	+0·0157	
	10·70	1·168	0·1590	-0·0603	
	13·30	1·308	0·1834	-0·0691	
	14·30	1·313	0·1995	-0·0667	
$\eta_w = -15^\circ$.	2·20	0·511	0·1243	0·0934	
	10·05	0·976	0·1115	0·0524	
	13·20	1·173	0·1329	0·0343	
	14·25	1·228	0·1428	0·0256	
	14·75	1·225	0·1516	0·0259	
	15·70	1·160	0·1741	0·0307	
	16·15	1·148	0·1825	0·0333	
With tip slats of 25 per cent. span Complete model. Flaps 60° . (with centre section flap). $\eta_w = 0^\circ$.	7·00	0·945	0·1324	-0·0377	
	10·15	1·131	0·1528	-0·0594	
	14·30	1·340	0·1952	-0·0602	
	15·35	1·363	0·2061	-0·0575	
	16·35	1·381	0·2227	-0·0457	
	17·30	1·357		-0·0378	
	$\eta_w = -15^\circ$.	2·15	0·481	0·1237	0·1029
		10·05	0·980	0·1486	0·0509
		13·15	1·158	0·1703	0·0353
		14·20	1·210	0·1821	0·0312
15·25		1·260		0·0271	
16·25		1·238	0·2149	0·0340	

* The basic cases with no slats are identical with the "no fin" results of Table 18.

TABLE 16—*continued*

Condition of model	α°	C_L	C_D	C_M
<i>With tip slats of 25 per cent. span</i> Wing alone. Flaps 0° $\eta_w = 0^\circ$.	12.95	0.847	0.0654	-0.0185
	16.10	1.031	0.0945	-0.0221
	19.20	1.176	0.1484	-0.0084
	23.30	1.329	0.2437	-0.0180
	26.35	1.373	0.3196	-0.0185
	27.35	1.395	0.3426	-0.0201
Wing alone. Flaps 60° (with centre section flap). $\eta_w = 0^\circ$.	6.95	0.881	0.1335	+0.0023
	10.10	1.081	0.1517	-0.0197
	13.25	1.275	0.1776	-0.0394
	15.35	1.368	0.2021	-0.0397
	16.35	1.419	0.2182	-0.0378
	17.40	1.436	0.2368	-0.0281
18.35	1.380	0.2644	-0.0135	

TABLE 17

1/5.67 scale model

28.4 deg. Sweepback

Tests with Inboard Fins. Elevons Sealed**Lift, Drag and Pitching-Moment Coefficients*

Condition of model	Inboard fin No.*	α°	C_L	C_D	C_M
Wing alone. Flaps 0° . $\eta_w = 0^\circ$	No fins	0.1	-0.002	0.0098	+0.0225
		6.45	+0.475	0.0221	-0.0072
		12.8	0.920	0.0616	-0.0307
		15.9	1.065	0.0925	-0.0178
		19.0	1.163	0.1455	+0.0123
		22.05	1.231	0.210	0.0269
		24.05	1.237	0.259	0.0259
		26.05	1.275	0.308	0.0158
		27.1	1.312		
		28.1	1.312		
$\eta_w = 0^\circ$	1	12.75	0.892	0.0637	-0.0272
		15.9	1.060	0.106	-0.0297
		19.0	1.203	0.155	-0.0273
		22.1	1.297	0.218	-0.0279
		24.1	1.353	0.283	-0.0437
		26.15	1.372	0.333	-0.0530
		27.15	1.383	0.361	-0.0587
		28.15	1.383		

* For details of the fins see section 11.1 and Fig. 34.

TABLE 17—continued

Condition of model	Inboard fin* No.	α°	C_L	C_D	C_M
Wing alone. Flaps 0° $\eta_w = -10^\circ$	1	9.5	0.519	0.0333	+0.0739
		12.65	0.745	0.0515	0.0567
		15.8	0.935	0.0851	0.0417
		18.9	1.078	0.132	0.0404
		21.95	1.156	0.192	0.0327
		24.0	1.190	0.237	0.0195
		26.05	1.256	0.296	0.0049
		27.05	1.281	0.317	-0.0008
$\eta_w = 0^\circ$	1 ^A	0.1	-0.017	0.0112	
		3.25	+0.225	0.0132	
		6.45	0.468	0.0230	-0.0069
		12.8	0.908	0.0631	-0.0279
		15.9	1.065	0.1021	-0.0294
		19.0	1.204	0.156	-0.0233
		22.05	1.266	0.221	-0.0221
		24.05	1.282	0.267	-0.0289
		26.1	1.344	0.335	-0.0368
		27.1	1.355	0.367	-0.0166
		28.15	1.359		
$\eta_w = 0^\circ$	1 ^B	15.9	1.073	0.0919	-0.0274
		19.0	1.188	0.151	-0.0041
		22.05	1.246	0.212	+0.0162
$\eta_w = 0^\circ$	1 ^C	15.9	1.062	0.0930	-0.0263
		19.0	1.180	0.146	-0.0119
		22.0	1.224		+0.0062
Wing alone. Flaps 0° . $\eta_w = 0^\circ$	2	0.1	-0.016	0.0126	+0.0241
		6.45	+0.465	0.0244	-0.0008
		12.75	0.883	0.0713	-0.0248
		15.9	1.057	0.108	-0.0308
		19.0	1.209	0.160	-0.0345
		22.1	1.309	0.233	-0.0478
		24.1	1.330	0.281	-0.0423
		26.1	1.339	0.327	-0.0315
27.1	1.330	0.353	-0.342		
$\eta_w = 0^\circ$	2 (upper surface half only)	0.1	-0.008	0.0115	
		3.25	+0.224	0.0136	
		6.45	0.464	0.0245	
		12.75	0.892	0.0715	-0.0279
		15.9	1.059	0.108	-0.0329
		19.0	1.212	0.157	-0.0353
		22.05	1.273	0.225	-0.0430
		24.05	1.282	0.270	-0.0346
		26.1	1.311	0.311	-0.0283
27.1	1.303				
$\eta_w = 0^\circ$	3	15.9	1.038	0.113	-0.0364
		19.0	1.182	0.161	-0.0402
		22.05	1.281	0.231	-0.0246
		24.1	1.314	0.279	-0.0242
$\eta_w = 0^\circ$	3 (upper surface half only)	12.8	0.905	0.0682	-0.0296
		15.9	1.050	0.112	-0.0385
		19.0	1.187	0.161	-0.0389
		22.1	1.305	0.228	-0.0253
		24.1	1.338	0.270	-0.0232
		26.05	1.291	0.312	-0.0299

* For details of the fins see section 11.1 and Fig. 34.

TABLE 17—continued

Condition of model	Inboard fin* No.	α°	C_L	C_D	C_M	
Wing alone. Flaps 60° . (with centre section flap). $\eta_w = 0^\circ$	No fins	3.65	0.734	0.133	-0.0114	
		6.8	0.954	0.151	-0.0318	
		10.0	1.165	0.174	-0.0497	
		13.1	1.350	0.203	-0.0554	
		14.7	1.428	0.228	-0.0500	
		16.2	1.461	0.253	-0.0367	
		17.15	1.370	0.275	-0.0201	
	$\eta_w = 0^\circ$	1	13.1	1.316	0.220	-0.0515
			14.65	1.398	0.242	-0.0543
			16.2	1.466	0.266	-0.0537
			17.25	1.501	0.281	-0.0507
			18.15	1.369	0.295	-0.0372
	$\eta_w = -10^\circ$	1	6.7	0.762	0.158	0.0720
			13.0	1.177	0.206	0.0349
			14.55	1.259	0.227	0.0255
			16.1	1.333	0.248	0.0186
			17.15	1.403	0.264	0.0137
	$\eta_w = 0^\circ$	2	3.65	0.719	0.138	-0.0075
			6.8	0.936	0.155	-0.0217
			9.95	1.120	0.186	-0.0359
			13.05	1.290	0.224	-0.0478
14.65			1.368	0.246	-0.0513	
16.2			1.431	0.266	-0.0496	
17.2			1.460	0.281	-0.0450	
18.2			1.472	0.300	-0.0387	
19.15			1.373	0.313	-0.0296	
Wing and end fins. Flaps 0° $\eta_w = 0^\circ$			No fins	6.45	0.468	0.0221
	12.8	0.923		0.0634	-0.0422	
	15.9	1.080		0.0955	-0.0279	
	19.0	1.188		0.147	+0.0033	
	22.05	1.259				
	24.05	1.240				
	$\eta_w = 0^\circ$	1	6.45	0.471	0.0238	-0.0143
			12.8	0.914	0.0675	-0.0393
			15.9	1.074	0.110	-0.0395
			19.0	1.215	0.161	-0.0355
			22.1	1.307	0.226	-0.0301
			24.1	1.340	0.285	-0.0357
			26.1	1.357	0.334	-0.0380
			27.15	1.391	0.371	-0.0395
			28.15	1.374	0.390	-0.0403
	$\eta_w = 0^\circ$	2	0.1	-0.017	0.0139	
			3.3	+0.232	0.0160	
			6.45	0.478	0.0261	
			12.8	0.904	0.0762	-0.0388
			15.9	1.065	0.114	-0.0434
			19.0	1.210	0.162	-0.0453
22.1			1.298	0.228	-0.0495	
24.1			1.334	0.279	-0.0413	
26.1	1.332	0.332	-0.0388			

* For details of the fins see section 11.1 and Fig. 34.

TABLE 18
1/5·67 scale model
36·4 deg. Sweepback
Tests with Inboard Fins*, Wing Alone, Elevons Unsealed
Lift, Drag and Pitching-Moment Coefficients

Condition of model	$\eta_w = 0^\circ$				$\eta_w = -10^\circ$			
	α°	C_L	C_D	C_M	α°	C_L	C_D	C_M
<i>Flaps 0°</i> No fins.	0·30	0·027	0·0122	+0·0195				
	6·65	0·468	0·0285	-0·0048				
	12·95	0·874	0·0671	-0·0210	12·90	0·773	0·0526	0·0396
	16·10	1·045	0·0955	-0·0251	16·00	0·941	0·0794	0·0392
	19·20	1·166	0·1461	+0·0221	19·10	1·041	0·1289	0·0844
	23·30	1·310	0·2438	0·0405	23·20	1·205	0·2166	0·0973
	25·30	1·347	0·3027	0·0471				
	26·30	1·354		0·0476				
	27·30	1·348	0·3514	0·0560				
With inboard fins.	3·50	0·240	0·0165	+0·0087	3·40	0·140	0·0192	0·0852
	6·65	0·449	0·0273	-0·0038	6·55	0·362	0·0247	0·0723
	12·95	0·846	0·0696	-0·0314	12·90	0·763	0·0583	0·0418
	16·05	1·010	0·1055	-0·0330	16·00	0·937	0·0922	0·0324
	19·20	1·172	0·1602	-0·0359	19·10	1·092	0·1427	0·0369
	23·30	1·343	0·2517	-0·0467	22·25	1·282	0·2335	0·0201
	25·35	1·366	0·3156	-0·0308	25·30	1·295	0·2859	0·0289
<i>Flaps 60° (with centre section flap).</i> No fins.	0·65	0·492	0·1016	+0·0252	3·75	0·580	0·1166	0·0896
	7·00	0·901	0·1313	-0·0096	6·90	0·785	0·1302	0·0713
	10·15	1·099	0·1527	-0·0273	10·05	0·988	0·1464	0·0505
	13·25	1·263	0·1779	-0·0340	13·20	1·175	0·1696	0·0367
	16·35	1·403	0·2168	-0·0200	16·30	1·308	0·2032	0·0441
	17·35	1·415	0·2303	+0·0043	17·30	1·341	0·2182	0·0554
	18·35	1·392	0·2507	0·0246	18·25	1·286	0·2488	0·0720
With inboard fins.	3·80	0·693	0·1148	+0·0109	3·75	0·576	0·1183	0·0936
	6·95	0·892	0·1321	-0·0062	6·90	0·785	0·1313	0·0754
	10·10	1·081	0·1601	-0·0250	10·05	0·972	0·1523	0·0566
	13·25	1·247	0·1939	-0·0364	13·15	1·150	0·1842	0·0385
	16·35	1·381	0·2351	-0·0307	16·25	1·287	0·2203	0·0377
	18·35	1·409	0·2721	-0·0230	17·30	1·334	0·2367	0·0371
	19·30	1·342	0·2945	-0·0123	18·30	1·298	0·2560	0·0420

* For details of the fins see Fig. 2.

TABLE 19

1/5·67 scale model

28·4 deg. Sweepback

*Lateral Derivatives with Inboard Fins (No. 2).** Elevons Sealed

Condition of model	α°	C_L	n_v	l_v	y_v
Wing alone. Flaps 0°. Inboard fins No. 2.	3·25	0·22	0·021	-0·027	-0·094
	7·5	0·52	0·032	-0·047	-0·099
	12·8	0·88	0·059	-0·057	-0·110
	15·9	1·06	0·069	-0·063	-0·115
	19·0	1·20	0·070	-0·037	-0·127
Wing alone. Flaps 60°. (with centre section flap). Inboard fins No. 2.	0·5	0·52	0·031	-0·061	-0·118
	11·0	1·19	0·075	-0·088	-0·141
	13·05	1·29	0·085	-0·100	-0·147
	17·2	1·46	0·098	-0·108	
Wing and end fins. Flaps 0°. No inboard fins.	3·3	0·24	0·054	-0·079	-0·158
	7·5	0·55	0·053	-0·096	-0·148
	12·8	0·92	0·072	-0·128	-0·121
	15·9	1·08	0·082	-0·176	-0·132
Wing and end fins. Flaps 0°. Inboard fins No. 2.	3·3	0·22	0·069	-0·080	-0·238
	7·5	0·55	0·070	-0·097	-0·228
	12·8	0·91	0·093	-0·061	-0·207
	15·9	1·07	0·097	-0·057	-0·210
	19·0	1·20	0·096	-0·028	-0·224

* For details of the fins see section 11.1 and Fig. 34.

TABLE 20
1/3·78 scale model
36·4 deg. Sweepback
Lift, Drag and Pitching-Moment Coefficients
Wing Alone. Elevons Sealed
Variable-incidence wing tips set at 0 deg.
(Gaps between main wing and tips unsealed)

Condition of model	$\eta_H = 0^\circ$				$\eta_H = -10^\circ$			
	α°	C_L	C_D	C_M	α°	C_L	C_D	C_M
Flaps 0°.	0·81	0·069	0·024	+0·010	0·75	-0·053	0·027	0·008
	3·51	0·297	0·024	-0·002	1·30	-0·031	0·027	0·092
	6·54	0·479	0·038	-0·010	2·50	+0·062	0·028	0·094
	9·56	0·676	0·054	-0·019	4·00	0·165	0·028	0·013
	12·69	0·865	0·0764	-0·022	6·00	0·314	0·033	0·080
	14·35	0·950	0·100	-0·021	6·60	0·382	0·038	0·075
	14·71	0·980	0·109	-0·023	8·14	0·469	0·045	0·066
	17·67	1·136	0·152	-0·024	9·90	0·591	0·049	0·058
	20·18	1·262	0·191	-0·019	12·80	0·793	0·069	0·043
	20·62	1·267	0·209	-0·019	14·20	0·882	0·086	0·038
	23·21	1·318	0·268	-0·015	14·60	0·896	0·088	0·037
	26·30	1·352	0·338	-0·017	16·20	1·003	0·118	0·035
	28·50	1·357	0·403	-0·016	18·90	1·162	0·158	0·037
	29·70	1·338	0·438	-0·023	20·90	1·195	0·197	0·038
					22·30	1·216	0·236	0·045
					24·60	1·253	0·220	0·046
					26·50	1·277	0·323	0·044
					28·60	1·286	0·373	0·033
				30·30	1·272	0·412	0·027	
Flaps 60° (with centre section flap).	- 0·36	0·529	0·129	+0·007	0·30	0·405	0·142	0·100
	+ 2·60	0·683	0·138	-0·008	2·40	0·559	0·145	0·086
	5·50	0·854	0·146	-0·025	5·40	0·739	0·152	0·070
	8·40	0·983	0·158	-0·034	8·40	0·913	0·166	0·053
	8·70	1·074	0·168	-0·035	11·20	1·080	0·185	0·047
	11·40	1·206	0·186	-0·051	14·00	1·220	0·218	0·024
	14·30	1·306	0·229	-0·042	14·10	1·240	0·222	0·021
	15·70	1·391	0·269	-0·043	15·50	1·297	0·243	0·022
	17·30	1·331	0·288	-0·030	17·20	1·241	0·280	0·033
	18·80	1·245	0·331	+0·002				
	20·30	1·230	0·351	0·011				
	23·30	1·230	0·407	0·011				

TABLE 21
1/3·78 scale model
36·4 deg. Sweepback
Lift, Drag and Pitching Moment Coefficients
Wing Alone. Elevons Sealed
Variable-incidence wing tips set at -15 deg.
(Gaps between main wing and tips unsealed)

Condition of model	$\eta_H = 0^\circ$				$\eta_H = +10^\circ$				
	α°	C_L	C_D	C_M	α°	C_L	C_D	C_M	
Flaps 0° .	- 0·20	-0·156	0·049	0·151	1·20	0·083	0·034	+0·046	
	+ 2·20	+0·035	0·040	0·138	4·10	0·297	0·036	0·023	
	5·43	0·250	0·042	0·122	7·00	0·520	0·047	0·005	
	8·35	0·450	0·049	0·109	10·24	0·730	0·066	-0·012	
	11·28	0·630	0·064	0·097	13·47	0·910	0·094	-0·015	
	13·99	0·850	0·089	0·089	14·45	0·950	0·103	-0·006	
	14·50	0·845	0·089	0·089	14·55	0·940	0·105	-0·009	
	17·10	0·990	0·130	0·094	16·56	1·050	0·136	-0·001	
	20·40	1·080	0·182	0·103	18·37	1·150	0·173	+0·007	
	23·00	1·170	0·230	0·117	21·13	1·250	0·216	0·013	
	26·00	1·210	0·291	0·120	23·23	1·270	0·266	0·027	
	28·35	1·200	0·354	0·125	24·83	1·280	0·298	0·035	
					27·93	1·280	0·367	0·076	
	Flaps 60° (with centre section flap).	- 0·12	0·354	0·156	0·149	0·32	0·521	0·140	+0·037
		+ 0·85	0·437	0·159	0·140	2·65	0·682	0·145	0·017
2·32		0·524	0·160	0·131	4·89	0·830	0·154	0·002	
4·46		0·669	0·163	0·118	7·64	0·966	0·170	-0·007	
6·99		0·832	0·172	0·103	10·29	1·120	0·201	-0·014	
9·34		0·967	0·183	0·088	10·47	1·138	0·196	-0·012	
11·39		1·091	0·196	0·077	12·90	1·209	0·217	+0·002	
12·95		1·173	0·213	0·076	14·43	1·265	0·239	0·014	
13·75		1·190	0·222	0·080	14·51	1·286	0·237	0·009	
14·34		1·213	0·227	0·080	16·89	1·344	0·268	0·017	
15·52		1·251	0·240	0·078	17·98	1·360	0·288	0·028	
17·30		1·306	0·263	0·085	19·15	1·195	0·310	0·056	
18·00		1·234	0·281	0·100					
19·27		1·125	0·305	0·126					

TABLE 22

1/3·78 scale model

36·4 deg. Sweepback

*Effect of Sealing Gaps Between Main Wing and V.I. Tips**Wing Alone. Elevons Sealed. Variable-incidence Tips at 0 deg.**Lift, Drag and Pitching-Moment Coefficients*

Gaps unsealed				Gaps sealed			
α°	C_L	C_D	C_M	α°	C_L	C_D	C_M
<i>Flaps 0°. Elevons 0°.</i>							
- 0·43	-0·063	0·033	+0·025	0·53	0·007	0·031	+0·018
+ 1·60	+0·078	0·030	0·015	3·64	0·239	0·035	0·003
4·23	0·261	0·033	0·001	6·27	0·418	0·038	-0·009
6·46	0·446	0·041	-0·010	8·41	0·567	0·047	-0·019
9·00	0·596	0·051	-0·017	11·24	0·745	0·064	-0·027
11·45	0·743	0·065	-0·027	13·19	0·865	0·080	-0·021
13·88	0·898	0·091	-0·030	14·00	0·947	0·087	-0·016
15·65	0·980	0·110	-0·032	15·60	1·030	0·112	+0·001
16·10	1·062	0·124	-0·024	17·60	1·110	0·148	0·025
18·30	1·169	0·159	-0·021	19·80	1·194	0·185	0·040
20·50	1·267	0·202	-0·020	21·80	1·267	0·230	0·052
22·70	1·317	0·247	-0·013	23·90	1·305	0·281	0·075
23·70	1·320	0·258	-0·010	26·10	1·315	0·335	0·081
25·20	1·336	0·299	+0·001	28·30	1·306	0·389	0·085
27·10	1·371	0·353	-0·007	30·00	1·318	0·439	0·091
29·60	1·339	0·421	-0·019				
<i>Flaps 60° (with centre section flap). Elevons -10°</i>							
- 1·46	0·252	0·144	0·114	- 0·49	0·313	0·146	0·117
+ 0·77	0·412	0·145	0·102	+ 2·43	0·507	0·148	0·095
3·40	0·588	0·149	0·087	5·35	0·705	0·152	0·078
5·85	0·728	0·157	0·074	8·28	0·904	0·161	0·056
8·57	0·917	0·170	0·053	11·21	1·081	0·175	0·034
10·93	1·035	0·188	0·041	14·14	1·246	0·198	0·019
13·18	1·160	0·213	0·025	17·10	1·366	0·235	0·027
14·16	1·213	0·228		19·18	1·144	0·308	0·091
16·52	1·311	0·260	0·019	21·19	1·136	0·336	0·104
18·68	1·145	0·302	0·052	23·18	1·148	0·378	0·107
20·38	1·151	0·331	0·054				
22·17	1·157	0·358	0·054				

TABLE 23

1/3·78 scale model

36·4 deg. Sweepback

Configuration of Pressure Holes at Sections A, B, C, D, F, G, H. Elevons and Flaps 0 deg.*
(see Fig. 63)

Upper Surface						
Station No.	$\frac{x_1}{c}$	Section B	Section F	Section G	Section C	Section H
		$\frac{t}{c}=0.172$	$\frac{t}{c}=0.169$	$\frac{t}{c}=0.167$	$\frac{t}{c}=0.162$	$\frac{t}{c}=0.155$
		$\frac{y_1}{c}$				
1	0	0	0	0	0	0
2	0.020	0.032	0.032	0.031	0.031	0.029
3	0.050	0.052	0.051	0.051	0.050	0.047
4	0.100	0.074	0.073	0.072	0.070	0.067
5	0.200	0.098	0.097	0.095	0.094	0.088
6	0.400	0.102	0.101	0.099	0.096	0.092
7	0.550	0.084	0.083	0.081	0.079	0.075
8	0.650	0.065	0.064	0.063	0.061	0.058
9	0.700	0.054	0.053	0.053	0.051	0.049
10	0.728	0.048	0.047	0.046	0.046	0.043
11	0.778	0.037	0.036	0.036	0.035	0.033
12	0.850	0.021	0.020	0.020	0.020	0.019
13	0.950	0.006	0.005	0.005	0.005	0.005

Lower Surface						
Station No.	$\frac{x_2}{c}$	$\frac{y_2}{c}$				
		14	0.900	-0.014	-0.014	-0.014
15	0.800	-0.029	-0.028	-0.027	-0.027	-0.026
16	0.700	-0.043	-0.042	-0.041	-0.040	-0.038
17	0.650	-0.050	-0.049	-0.048	-0.046	-0.044
18	0.500	-0.062	-0.061	-0.060	-0.059	-0.056
19	0.250	-0.066	-0.065	-0.064	-0.062	-0.059
20	0.100	-0.052	-0.051	-0.051	-0.050	-0.047
21	0.050	-0.041	-0.040	-0.040	-0.039	-0.037
22	0.020	-0.027	-0.026	-0.026	-0.025	-0.024

Upper Surface			
Station No.	$\frac{x_1}{c}$	Section A	Section D
		$\frac{t}{c}=0.178$	$\frac{t}{c}=0.176$
		$\frac{y_1}{c}$	
1	0	0	0
2	0.02	0.033	0.033
3	0.05	0.054	0.054
4	0.10	0.077	0.076
5	0.20	0.102	0.100
6	0.40	0.106	0.104
7	0.60	0.078	0.077
8	0.80	0.033	0.033
9	0.95	0.006	0.006

Lower Surface			
Station No.	$\frac{x_2}{c}$	$\frac{y_2}{c}$	
		10	0.90
11	0.75	-0.038	-0.038
12	0.60	-0.056	-0.055
13	0.40	-0.068	-0.067
14	0.20	-0.067	-0.066
15	0.10	-0.054	-0.054
16	0.05	-0.042	-0.042
17	0.02	-0.027	-0.027

* Tables 24 and 25 give the configuration of the pressure holes affected when the flaps are added and the elevons are deflected. x_1 and y_2 are given in terms of local chord measured with elevons undeflected.

TABLE 24

1/3·78 scale model
36·4 deg. Sweepback

Configuration of Pressure Holes* on Elevon for Elevon Deflections of ± 10 deg. (see Fig. 63B)

$$\eta_H = +10^\circ$$

	Station No.	Section B		Section F		Section G		Section C		Section H	
		$\frac{x}{c}$	$\frac{y}{c}$	$\frac{x}{c}$	$\frac{y}{c}$	$\frac{x}{c}$	$\frac{y}{c}$	$\frac{x}{c}$	$\frac{y}{c}$	$\frac{x}{c}$	$\frac{y}{c}$
Upper Surface	9	0·709	+0·054	0·709	+0·053	0·709	+0·052	0·708	+0·050	0·708	+0·048
	10	0·736	0·043	0·736	0·043	0·736	0·042	0·735	0·041	0·735	0·039
	11	0·783	0·023	0·783	0·023	0·783	0·023	0·783	0·021	0·781	0·020
	12	0·851	-0·005	0·851	-0·006	0·851	-0·006	0·851	-0·006	0·851	-0·007
	13	0·946	-0·037	0·946	-0·037	0·946	-0·037	0·946	-0·037	0·946	-0·038
Lower Surface	14	0·894	-0·048	0·894	-0·048	0·894	-0·048	0·894	-0·048	0·894	-0·047
	15	0·793	-0·046	0·793	-0·045	0·794	-0·045	0·794	-0·044	0·794	-0·043
	16	0·692	-0·042	0·692	-0·042	0·692	-0·041	0·692	-0·040	0·693	-0·038

$$\eta_H = -10^\circ$$

Upper Surface	9	0·690	0·054	0·690	0·053	0·690	0·052	0·691	0·050	0·691	0·048
	10	0·719	0·051	0·719	0·051	0·719	0·050	0·720	0·049	0·720	0·047
	11	0·770	0·049	0·770	0·049	0·770	0·049	0·770	0·047	0·771	0·046
	12	0·844	0·047	0·844	0·046	0·844	0·046	0·844	0·045	0·844	0·045
	13	0·945	0·049	0·946	0·048	0·946	0·048	0·945	0·049	0·947	0·048
Lower Surface	14	0·899	+0·021	0·899	+0·021	0·899	+0·021	0·899	+0·021	0·899	+0·022
	15	0·803	-0·012	0·803	-0·011	0·803	-0·010	0·803	-0·009	0·803	-0·008
	16	0·707	-0·042	0·707	-0·042	0·707	-0·041	0·706	-0·040	0·706	-0·038

* x and y are given in terms of local chord measured with elevons undeflected.

TABLE 25

1/3·78 scale model
36·4 deg. Sweepback

Configuration of Pressure Holes on Front and Rear Surfaces of Flap (Flap Angle 60 deg.) (see Fig. 63A)

Rear Surface				
Station No.	Section A		Section D	
	$\frac{x}{c}$	$\frac{y}{c}$	$\frac{x}{c}$	$\frac{y}{c}$
18	0·752	0·136	0·752	0·134
Front Surface				
19	0·787	0·196	0·785	0·192
20	0·716	0·072	0·717	0·073

TABLE 26
 1/3·78 scale model
 36·4 deg. Sweepback
 Wing Alone, Elevons Sealed
 Values of C_p , Pressure Coefficient Measured on One Half of Complete Wing
 Flaps 0 deg. Elevons 0 deg.

Station No.	$\alpha = 1\cdot63^*$						
	Section						
	A	B	C	D	F	G	H
1	+0·524	+0·547	+0·533	+0·520	+0·510	+0·531	+0·390
2	0·129	0·158	0·136	0·039	0·126	0·093	0·238
3	-0·178	-0·251	-0·219	-0·216	-0·422	-0·200	-0·019
4	-0·479	-0·553	-0·407	-0·568	-0·621	-0·456	-0·276
5	-0·664	-0·634	-0·579	-0·661	-0·621	-0·640	-0·469
6	-0·590	-0·584	-0·473	-0·598	-0·536	-0·521	-0·401
7	-0·277	-0·311	-0·312	-0·222	-0·295	-0·337	-0·298
8	+0·014	-0·218	-0·174	+0·033	-0·206	-0·206	-0·184
9	0·133	-0·060	+0·016	0·151	+0·077	-0·052	+0·023
10	0·059	-0·062	-0·048	0·083	-0·063	-0·049	-0·037
11	-0·087	+0·006	+0·029	-0·060	-0·001	+0·033	+0·050
12	-0·215	0·075	0·091	-0·189	+0·068	0·096	0·092
13	-0·232	0·119	0·129	-0·251	0·131	0·138	0·111
14	-0·321	0·099	0·090	-0·360	0·104	0·088	0·093
15	-0·274	0·024	0·015	-0·293	0·033	0·030	0·029
16	-0·216	-0·056	0·002	-0·205	-0·003	-0·097	-0·010
17	+0·049	-0·121	-0·146	-0·057	-0·139	-0·141	-0·130
18		-0·196	-0·187		-0·227	-0·195	-0·200
19		-0·286	-0·338		-0·314	-0·322	-0·362
20		-0·305	-0·375		-0·324	-0·339	-0·461
21		-0·243	-0·328		-0·276	-0·331	-0·485
22		-0·064	-0·048		-0·077	-0·038	-0·373
E		-0·177	-0·149		-0·129	-0·170	-0·149
	$\alpha = 5\cdot41^*$						
1	+0·430	+0·329	+0·469	+0·384	+0·392	+0·384	+0·528
2	-0·315	-0·392	-0·446	-0·565	-0·461	-0·501	-0·259
3	-0·581	-0·755	-0·645	-0·733	-0·730	-0·740	-0·494
4	-0·863	-1·027	-0·872	-1·062	-1·153	-0·934	-0·708
5	-0·932	-0·971	-0·896	-0·994	-0·974	-0·995	-0·774
6	-0·707	-0·735	-0·620	-0·745	-0·658	-0·664	-0·569
7	-0·340	-0·406	-0·402	-0·331	-0·401	-0·436	-0·327
8	-0·009	-0·257	-0·238	+0·005	-0·256	-0·257	-0·231
9	+0·135	-0·120	-0·112	0·135	-0·078	-0·131	-0·052
10	-0·080	-0·105	-0·097	0·102	-0·111	-0·092	-0·063
11	-0·038	-0·026	-0·014	-0·015	-0·038	-0·007	+0·020
12	-0·130	+0·052	+0·056	-0·105	+0·040	+0·065	0·074
13	-0·100	0·112	0·116	-0·108	0·118	0·123	0·097
14	-0·102	0·107	0·092	-0·102	0·114	0·098	0·075
15	+0·020	0·058	0·056	+0·045	0·070	0·058	0·033
16	0·166	0·061	-0·048	0·199	-0·006	-0·051	-0·022
17	0·406	-0·069	-0·112	0·375	-0·089	-0·076	-0·116
18		-0·103	-0·126		-0·125	-0·098	-0·163
19		-0·097	-0·149		-0·115	-0·117	-0·191
20		+0·009	-0·040		0	-0·002	-0·126
21		0·151	+0·124		+0·174	+0·108	+0·007
22		0·358	0·409		0·390	0·435	0·219
E		-0·145	-0·175		-0·152	-0·180	-0·161

* Incidence of centre section of wing corrected for tunnel constraint.

TABLE 27
1/3·78 scale model
36·4 deg. Sweepback
Wing Alone, Elevons Sealed
Values of C_p , Pressure Coefficient Measured on One Half of Complete Wing
Flaps 0 deg. Elevons 0 deg.

Station No.	$\alpha = 9\cdot39^*$			$\alpha = 9\cdot20^*$			
	Section			Section			
	A	B	C	D	F	G	H
1	+0·036	-0·387	-0·126	-0·081	-0·243	-0·238	-0·230
2	-0·879	-1·186	-1·264	-1·283	-1·236	-1·286	-0·952
3	-1·076	-1·423	-1·309	-1·288	-1·381	-1·360	-1·058
4	-1·283	-1·578	-1·414	-1·550	-1·706	-1·445	-1·179
5	-1·234	-1·358	-1·273	-1·312	-1·325	-1·336	-1·084
6	-0·844	-0·894	-0·766	-0·886	-0·796	-0·801	-0·597
7	-0·395	-0·452	-0·470	-0·370	-0·446	+0·485	-0·397
8	-0·033	-0·224	-0·264	-0·020	-0·237	-0·254	-0·269
9	+0·114	-0·130	-0·163	+0·101	-0·113	-0·136	-0·123
10	0·102	-0·095	-0·123	0·110	-0·090	-0·091	-0·101
11	0·014	-0·045	-0·046	0·021	-0·041	-0·024	-0·022
12	-0·051	-0·006	+0·036	-0·037	+0·003	+0·025	+0·039
13	+0·017	+0·036	0·081	+0·008	0·053	0·069	0·063
14	0·080	0·088	0·081	0·092	0·012	0·088	0·049
15	0·246	0·074	0·047	0·276	0·078	0·071	0·015
16	0·404	0·086	0·054	0·434	0·079	-0·014	0
17	0·505	-0·010	-0·061	0·530	-0·028	-0·020	0·099
18		0	-0·050		-0·035	-0·019	-0·114
19		+0·074	+0·031		+0·055	+0·049	-0·046
20		0·263	0·219		0·250	0·242	+0·134
21		0·417	0·443		0·426	0·386	0·327
22		0·530	0·537		0·547	0·543	0·484
E		-0·101	-0·176		-0·090	-0·152	-0·168
	$\alpha = 13\cdot30^*$			$\alpha = 13\cdot30^*$			
1	-0·708	-1·577	-1·238	-0·990	-1·488	-1·388	-0·637
2	-1·646	-2·215	-2·249	-2·250	-2·253	-2·306	-1·789
3	-1·697	-2·212	-2·027	-1·993	-2·170	-2·100	-1·665
4	-1·770	-2·193	-1·925	-2·120	-2·279	-1·979	-1·619
5	-1·703	-1·600	-1·467	-1·536	-1·534	-1·567	-1·333
6	-0·977	-0·969	-0·707	-1·004	-0·848	-0·787	-0·635
7	-0·423	-0·378	-0·277	-0·371	-0·343	-0·307	-0·328
8	-0·063	-0·190	-0·135	-0·103	-0·194	-0·165	-0·163
9	+0·078	-0·147	-0·123	0	-0·157	-0·141	-0·086
10	0·122	-0·139	-0·113	+0·124	-0·152	-0·145	-0·067
11	0·068	-0·136	-0·112	0·068	-0·156	-0·146	-0·045
12	0·035	-0·126	-0·110	0·045	-0·166	-0·145	-0·022
13	0·135	-0·107	-0·090	0·134	-0·155	-0·154	-0·008
14	0·250	+0·056	+0·006	0·275	-0·072	+0·019	-0·007
15	0·421	0·073	0·014	0·455	+0·071	0·049	-0·021
16	0·540	0·103	0·027	0·543	0·115	-0·003	-0·020
17	0·455	0·033	-0·048	0·452	0·012	+0·117	-0·108
18		0·076	+0·005		0·042	0·051	-0·087
19		0·222	0·165		0·205	0·195	+0·068
20		0·431	0·404		0·443	0·422	0·316
21		0·532	0·543		0·545	0·532	0·490
22		0·454	0·341		0·446	0·356	0·498
E		-0·081	-0·211		-0·059	-0·129	-0·091

* Incidence of centre section of wing corrected for tunnel constraint.

TABLE 28

1/3·78 scale model

36·4 deg. Sweepback

Wing Alone, Elevons Sealed

Values of C_p , Pressure Coefficient Measured on One Half of Complete Wing

Flaps 0 deg.

Elevons 0 deg.

Station No.	$\alpha = 17\cdot22^*$			$\alpha = 17\cdot12^*$			
	Section			Section			
	A	B	C	D	F	G	H
1	-1.575	-2.783	-1.889	-2.053	-2.741	-2.418	-1.069
2	-2.401	-3.096	-2.537	-3.204	-3.089	-2.997	-1.953
3	-2.253	-2.831	-2.091	-2.669	-2.778	-2.566	-1.708
4	-2.167	-2.635	-1.639	-2.571	-2.687	-2.103	-1.394
5	-1.684	-1.738	-0.856	-1.851	-1.638	-1.399	-0.836
6	-1.067	-0.743	-0.328	-1.066	-0.568	-0.441	-0.279
7	-0.461	-0.393	-0.323	-0.448	-0.426	-0.412	-0.264
8	-0.138	-0.394	-0.332	-0.378	-0.415	-0.411	-0.261
9	+0.044	-0.381	-0.323	-0.121	-0.408	-0.403	-0.257
10	0.156	-0.369	-0.323	+0.157	-0.407	-0.410	-0.252
11	0.114	-0.384	-0.323	0.115	-0.428	-0.427	-0.259
12	0.116	-0.399	-0.311	0.117	-0.460	-0.456	-0.260
13	0.170	-0.367	-0.308	0.233	-0.417	-0.434	-0.273
14	0.381	-0.003	-0.095	0.405	-0.020	-0.074	-0.111
15	0.537	+0.057	-0.058	0.545	+0.040	0	-0.083
16	0.569	0.140	+0.056	0.531	0.126	-0.024	-0.046
17	0.212	0.056	-0.074	0.195	0.019	+0.016	-0.133
18		0.142	+0.017		0.088	0.083	-0.080
19		0.329	0.231		0.305	0.285	+0.120
20		0.536	0.478		0.530	0.510	0.387
21		0.661	0.567		0.546	0.556	0.516
22		0.248	0.118		0.197	0.050	0.421
E		-0.180	-0.285		-0.130	-0.344	-0.227
	$\alpha = 21\cdot15^*$			$\alpha = 21\cdot05^*$			
1	-2.821	-4.081	-2.451	-3.467	-4.027	-3.161	-1.628
2	-3.416	-3.913	-2.804	-4.398	-3.728	-3.342	-2.147
3	-2.815	-3.256	-1.794	-3.192	-2.988	-2.236	-1.480
4	-2.645	-2.796	-1.448	-3.104	-2.727	-1.682	-1.195
5	-1.982	-1.624	-0.491	-2.103	-1.218	-0.669	-0.482
6	-1.178	-0.819	-0.458	-1.017	-0.712	-0.555	-0.360
7	-0.583	-0.776	-0.416	-0.724	-0.699	-0.542	-0.342
8	-0.268	-0.733	-0.428	-0.775	-0.665	-0.533	-0.345
9	+0.075	-0.633	-0.400	-0.251	-0.626	-0.503	-0.343
10	0.204	-0.625	-0.410	+0.180	-0.616	-0.509	-0.341
11	0.192	-0.613	-0.409	0.166	-0.620	-0.508	-0.354
12	0.206	-0.575	-0.399	0.195	-0.605	-0.491	-0.360
13	0.339	-0.492	-0.386	0.337	-0.517	-0.473	-0.372
14	0.501	-0.025	-0.122	0.511	-0.065	-0.110	-0.152
15	0.603	+0.050	-0.062	0.591	+0.029	-0.015	-0.099
16	0.494	0.171	+0.065	0.428	0.141	-0.023	-0.042
17	-0.236	0.084	-0.061	-0.264	0.039	+0.039	-0.128
18		0.196	+0.052		0.138	0.127	-0.048
19		0.432	0.304		0.394	0.368	+0.187
20		0.578	0.502		0.583	0.570	0.447
21		0.521	0.541		0.491	0.541	0.510
22		-0.034	-0.103		-0.133	-0.265	0.278
E		-0.265	-0.350		-0.182	-0.434	-0.296

* Incidence of centre section of wing corrected for tunnel constraint.

TABLE 29
1/3·78 scale model
36·4 deg. Sweepback
Wing Alone, Elevons Sealed
Values of C_p , Pressure Coefficient Measured on One Half of Complete Wing
Flaps 0 deg. Elevons 0 deg.

Station No.	$\alpha = 25\cdot11^*$			$\alpha = 25\cdot21^*$			
	Section			Section			
	A	B	C	D	F	G	H
1	-4·263	-3·810	-2·614	-4·883	-3·748	-2·987	-1·736
2	-4·599	-3·151	-2·775	-5·333	-2·878	-2·826	-1·894
3	-3·388	-2·307	-1·443	-3·785	-1·983	-1·449	-1·164
4	-3·031	-1·532	-0·711	-3·401	-1·021	-0·780	-0·764
5	-2·191	-0·854	-0·459	-2·041	-0·702	-0·625	-0·458
6	-1·212	-0·777	-0·443	-1·170	-0·656	-0·554	-0·424
7	-0·779	-0·728	-0·436	-1·112	-0·637	-0·532	-0·408
8	-0·347	-0·736	-0·448	-0·897	-0·617	-0·525	-0·419
9	+0·077	-0·691	-0·414	-0·683	-0·590	-0·493	-0·407
10	0·204	-0·669	-0·425	+0·050	-0·574	-0·501	-0·402
11	0·223	-0·677	-0·426	0·128	-0·570	-0·496	-0·414
12	0·267	-0·667	-0·422	0·216	-0·560	-0·486	-0·403
13	0·425	-0·636	-0·401	0·404	-0·530	-0·467	-0·411
14	0·594	-0·130	-0·122	0·593	-0·099	+0·108	-0·174
15	0·624	-0·001	-0·051	0·594	+0·005	-0·008	-0·102
16	0·330	+0·148	+0·077	0·242	0·144	-0·007	-0·027
17	-0·828	0·062	-0·034	-0·081	0·037	+0·060	-0·110
18		0·249	+0·093		0·162	0·157	-0·010
19		0·471	0·358		0·439	0·412	+0·242
20		0·583	0·555		0·619	0·591	0·488
21		0·476	0·508		0·476	0·522	0·499
22		-0·132	-0·269		-0·186	-0·363	0·188
E		-0·335	-0·362		-0·161	-0·424	-0·338

* Incidence of centre section of wing corrected for tunnel constraint.

TABLE 30
1/3·78 scale model
36·4 deg. Sweepback
Wing Alone. Elevons Sealed
Values of C_p , Pressure Coefficient Measured on One Half of Complete Wing
Flaps 0 deg. Elevons - 10 deg.

Station No.	$\alpha = 9\cdot07^*$			$\alpha = 9\cdot35^*$			
	Section			Section			
	A	B	C	D	F	G	H
1	+0·053	-0·291	+0·094	-0·073	-0·119	-0·069	+0·371
2	-0·864	-1·097	-0·997	-1·242	-1·102	-1·060	-0·664
3	-1·064	-1·342	-1·097	-1·264	-1·254	-1·195	-0·797
4	-1·266	-1·499	-1·211	-1·516	-1·574	-1·274	-0·941
5	-1·226	-1·278	-1·067	-1·284	-1·201	-1·170	-0·891
6	-0·835	-0·800	-0·586	-0·857	-0·671	-0·649	-0·415
7	-0·384	-0·342	-0·260	-0·352	-0·296	-0·306	-0·201
8	-0·028	-0·108	-0·036	0	-0·074	-0·053	-0·023
9	+0·112	+0·022	+0·108	+0·110	-0·037	+0·059	+0·130
10	0·091	0·056	0·124	0·085	+0·072	0·083	0·169
11	-0·001	0·072	0·124	-0·001	0·085	0·107	0·163
12	-0·068	0·106	0·137	-0·042	0·109	0·130	0·150
13	-0·002	0·120	0·137	-0·011	0·133	0·142	0·118
14	+0·069	0·049	0·048	+0·076	0·079	0·047	0·044
15	0·234	-0·048	-0·070	0·268	-0·039	-0·051	-0·073
16	0·392	-0·460	-0·419	0·430	-0·495	-0·481	-0·428
17	0·530	-0·151	-0·244	0·535	-0·209	-0·196	-0·265
18		-0·096	-0·154		-0·142	-0·145	-0·217
19		+0·013	-0·066		-0·013	-0·037	-0·138
20		0·216	+0·137		+0·211	+0·175	+0·030
21		0·379	0·340		0·392	0·326	0·231
22		0·517	0·538		0·540	0·552	0·436
E		-0·110	-0·215		-0·175	-0·197	-0·224
	$\alpha = 13\cdot25^*$			$\alpha = 13\cdot44^*$			
1	-0·711	-1·458	-0·925	-0·967	-1·309	-1·179	-0·389
2	-1·644	-2·111	-1·971	-2·227	-2·130	-2·128	-1·590
3	-1·682	-2·119	-1·815	-1·963	-2·061	-1·951	-1·486
4	-1·765	-2·099	-1·751	-2·100	-2·182	-1·852	-1·469
5	-1·582	-1·523	-1·376	-1·515	-1·480	-1·497	-1·218
6	-0·958	-0·883	-0·631	-0·982	-0·772	-0·703	-0·540
7	-0·412	-0·303	-0·198	-0·351	-0·263	-0·224	-0·238
8	-0·057	-0·156	-0·077	-0·083	-0·152	-0·116	-0·046
9	+0·082	-0·131	-0·072	+0·002	-0·128	-0·101	+0·054
10	0·120	-0·132	-0·057	0·097	-0·138	-0·103	0·092
11	0·064	-0·111	-0·041	0·040	-0·123	-0·090	0·102
12	0·029	-0·057	-0·007	0·025	-0·075	-0·060	0·104
13	0·133	+0·044	+0·046	0·119	+0·043	+0·004	0·079
14	0·255	0·053	0·021	0·269	0·067	0·022	0·294
15	0·428	-0·016	-0·063	0·453	-0·018	-0·037	-0·085
16	0·540	-0·331	-0·376	0·545	-0·408	-0·421	-0·417
17	0·451	-0·089	-0·198	0·452	-0·139	-0·117	-0·238
18		+0·007	-0·076		-0·043	-0·045	-0·162
19		0·202	+0·102		+0·154	+0·138	+0·009
20		0·416	0·356		0·413	0·387	0·267
21		0·527	0·522		0·540	0·515	0·458
22		0·466	0·417		0·475	0·415	0·522
E		-0·152	-0·204		-0·174	-0·161	-0·225

* Incidence of centre section of wing corrected for tunnel constraint.

TABLE 31
1/3·78 scale model
36·4 deg. Sweepback
Wing Alone. Elevons Sealed
Values of C_p , Pressure Coefficient Measured on One Half of Complete Wing
Flaps 0 deg. Elevons -10 deg.

Station No.	$\alpha = 15\cdot10^*$			$\alpha = 15\cdot30^*$			
	Section			Section			
	A	B	C	D	F	G	H
1	-1·129	-2·029	-1·370	-1·466	-1·907	-1·701	-0·734
2	-1·998	-2·538	-2·275	-2·690	-2·560	-2·519	-1·850
3	-1·953	-2·419	-1·999	-2·301	-2·380	-2·232	-1·666
4	-1·952	-2·318	-1·832	-2·341	-2·379	-2·026	-1·564
5	-1·606	-1·574	-1·275	-1·567	-1·527	-1·475	-1·164
6	-1·006	-0·838	-0·375	-1·008	-0·719	-0·541	-0·433
7	-0·433	-0·291	-0·188	-0·351	-0·263	-0·260	-0·143
8	-0·083	-0·256	-0·184	-0·164	-0·235	-0·248	-0·086
9	+0·063	-0·237	-0·183	-0·052	-0·227	-0·238	-0·067
10	0·134	-0·227	-0·184	+0·109	-0·253	-0·252	-0·054
11	0·089	-0·217	-0·184	0·065	-0·259	-0·264	-0·041
12	0·068	-0·182	-0·175	0·050	-0·240	-0·249	-0·009
13	0·181	-0·075	-0·139	0·173	-0·099	-0·196	+0·018
14	0·319	+0·036	-0·060	0·336	+0·040	-0·031	-0·022
15	0·489	-0·009	-0·112	0·503	-0·024	-0·064	-0·111
16	0·568	-0·318	-0·401	0·547	-0·392	-0·423	-0·425
17	0·362	-0·070	-0·212	0·344	-0·127	-0·107	-0·257
18		+0·045	-0·057		-0·006	-0·019	-0·150
19		0·251	+0·161		+0·216	+0·201	+0·053
20		0·480	0·427		0·468	0·444	0·325
21		0·551	0·555		0·554	0·548	0·500
22		0·376	0·295		0·374	0·270	0·484
E		-0·123	-0·247		-0·183	-0·187	-0·263
	$\alpha = 17\cdot05^*$			$\alpha = 17\cdot24^*$			
1	-1·630	-2·660	-1·621	-2·051	-2·521	-2·150	-0·847
2	-2·427	-2·994	-2·343	-3·191	-2·938	-2·786	-1·844
3	-2·266	-2·739	-1·980	-2·661	-2·642	-2·406	-1·599
4	-2·166	-2·520	-1·584	-2·550	-2·523	-1·959	-1·410
5	-1·694	-1·672	-0·861	-1·819	-1·518	-1·294	-0·866
6	-1·063	-0·591	-0·300	-1·030	-0·471	-0·371	-0·243
7	-0·450	-0·361	-0·277	-0·431	-0·369	-0·369	-0·227
8	-0·127	-0·371	-0·283	-0·360	-0·383	-0·371	-0·236
9	+0·048	-0·366	-0·280	-0·128	-0·378	-0·358	-0·227
10	0·149	-0·355	-0·282	+0·133	-0·393	-0·382	-0·223
11	0·115	-0·361	-0·282	0·094	-0·421	-0·397	-0·217
12	0·105	-0·349	-0·280	0·102	-0·433	-0·390	-0·187
13	0·227	-0·238	-0·259	0·225	-0·304	-0·342	-0·143
14	0·375	-0·021	-0·138	0·401	-0·047	-0·116	-0·099
15	0·535	-0·016	-0·172	0·547	-0·087	-0·117	-0·171
16	0·567	-0·344	-0·455	0·535	-0·444	-0·477	-0·490
17	0·225	-0·069	-0·248	0·196	-0·148	-0·129	-0·300
18		+0·069	-0·066		+0·001	-0·011	-0·168
19		0·297	+0·182		0·259	+0·242	+0·066
20		0·522	0·450		0·513	0·493	0·348
21		0·561	0·560		0·552	0·563	0·511
22		0·278	0·219		0·233	0·139	0·462
E		-0·135	-0·310		-0·219	-0·236	-0·326

* Incidence of centre section of wing corrected for tunnel constraint.

TABLE 33
1/3·78 scale model
36·4 deg. Sweepback
Wing Alone. Elevons Sealed
Values of C_p , Pressure Coefficient Measured on One Half of Complete Wing
Flaps 0 deg. Elevons -10 deg.

Station No.	$\alpha = 28\cdot93^*$			$\alpha = 29\cdot13^*$			
	Section			Section			
	A	B	C	D	F	G	H
1	-4·946	-3·727	-1·833	-5·611	-3·702	-2·912	-0·594
2	-5·366	-2·661	-1·584	-5·625	-2·386	-2·195	-0·518
3	-3·816	-1·794	-0·945	-3·592	-1·423	-1·014	-0·520
4	-3·269	-0·788	-0·673	-2·731	-0·762	-0·627	-0·522
5	-2·251	-0·806	-0·550	-1·221	-0·681	-0·601	-0·495
6	-1·229	-0·745	-0·502	-1·065	-0·651	-0·550	-0·476
7	-1·083	-0·722	-0·490	-1·029	-0·627	-0·543	-0·477
8	-0·655	-0·722	-0·486	-0·920	-0·611	-0·530	-0·470
9	-0·267	-0·715	-0·450	-0·785	-0·582	-0·500	-0·442
10	+0·154	-0·683	-0·469	-0·052	-0·586	-0·514	-0·451
11	0·232	-0·669	-0·473	+0·069	-0·584	-0·514	-0·464
12	0·301	-0·651	-0·463	0·204	-0·571	-0·501	-0·452
13	0·480	-0·631	-0·451	0·437	-0·543	-0·487	-0·449
14	0·644	-0·240	-0·234	0·627	-0·209	-0·217	-0·273
15	0·609	-0·161	-0·224	0·574	-0·185	-0·169	-0·262
16	0·138	-0·483	-0·433	0·107	-0·522	-0·504	-0·529
17	-1·407	-0·074	-0·212	-1·160	-0·138	-0·077	-0·290
18		+0·176	+0·033		+0·106	+0·097	-0·087
19		0·487	0·360		0·448	0·419	+0·211
20		0·573	0·584		0·617	0·604	0·476
21		0·415	0·555		0·463	0·512	0·528
22		-0·241	-0·089		-0·245	-0·385	0·386
E		-0·192	-0·336		-0·276	-0·251	-0·388

* Incidence of centre section of wing corrected for tunnel constraint.

TABLE 34

1/3·78 scale model

36·4 deg. Sweepback

Wing Alone. Elevons Sealed

Values of C_p , Pressure Coefficient Measured on One Half of Complete Wing

Flaps 60 deg.

Elevons 0 deg.

Station No.	$\alpha = 5\cdot34^*$			$\alpha = 5\cdot14^*$			
	Section			Section			
	A	B	C	D	F	G	H
1	+0·118	-0·452	+0·092	-0·131	-0·243	-0·128	+0·381
2	-0·756	-1·213	-0·997	-1·292	-1·218	-1·166	-0·606
3	-0·996	-1·460	-1·125	-1·304	-1·385	-1·290	-0·808
4	-1·249	-1·658	-1·296	-1·604	-1·762	-1·401	-0·988
5	-1·284	-1·463	-1·209	-1·431	-1·417	-1·368	-0·978
6	-1·028	-1·108	-0·788	-1·120	-0·935	-0·889	-0·626
7	-0·659	-0·680	-0·512	-0·674	-0·619	-0·614	-0·400
8	-0·340	-0·482	-0·312	-0·323	-0·423	-0·390	-0·287
9	-0·332	-0·400	-0·200	-0·253	-0·281	-0·270	-0·141
10	-0·454	-0·346	-0·161	-0·326	-0·277	-0·210	-0·107
11	-0·464	-0·250	-0·075	-0·320	-0·184	-0·105	-0·023
12	+0·521	-0·144	+0·007	+0·424	-0·086	-0·023	+0·041
13	0·358	-0·060	0·090	0·335	+0·023	+0·057	0·063
14	0·247	-0·061	0·077	0·288	0·062	0·061	0·054
15	0·315	-0·065	0·027	0·385	0·003	0·043	0·015
16	0·426	-0·036	0·005	0·487	0·043	-0·040	-0·007
17	0·543	-0·082	-0·088	0·531	-0·068	-0·053	-0·103
18	-0·453	-0·013	-0·086	-0·324	-0·056	-0·064	-0·140
19	+0·262	+0·136	-0·045	+0·242	+0·037	-0·001	-0·109
20	0·506	0·291	+0·129	0·373	0·236	+0·175	+0·038
21		0·411	0·320		0·390	0·317	0·202
22		0·491	0·516		0·508	0·510	0·403
E		-0·275	-0·212		-0·138	-0·262	-0·191
	$\alpha = 9\cdot23^*$			$\alpha = 9\cdot04^*$			
1	-0·493	-1·483	-0·767	-0·975	-1·336	-1·117	-0·262
2	-1·418	-2·129	-1·865	-2·214	-2·170	-2·132	-1·383
3	-1·541	-2·177	-1·820	-1·997	-2·168	-2·035	-1·455
4	-1·691	-2·230	-1·825	-2·192	-2·395	-2·006	-1·517
5	-1·594	-1·862	-1·575	-1·736	-1·826	-1·775	-1·322
6	-1·158	-1·274	-0·928	-1·294	-1·133	-1·055	-0·731
7	-0·713	-0·758	-0·555	-0·731	-0·704	-0·663	-0·468
8	-0·365	-0·518	-0·312	-0·352	-0·440	-0·381	-0·326
9	-0·319	-0·429	-0·203	-0·257	-0·306	-0·253	-0·190
10	-0·409	-0·371	-0·161	-0·293	-0·269	-0·202	-0·148
11	-0·417	-0·278	-0·095	-0·285	-0·204	-0·137	-0·072
12	+0·557	-0·182	-0·037	+0·455	-0·136	-0·087	-0·001
13	0·423	-0·077	+0·024	0·395	-0·045	-0·024	+0·026
14	0·370	-0·046	0·057	0·402	+0·051	+0·045	0·018
15	0·462	-0·025	0·039	0·502	0·018	0·051	-0·007
16	0·553	+0·021	0·060	0·544	-0·085	-0·008	-0·019
17	0·492	-0·027	-0·047	0·414	-0·019	-0·007	-0·101
18	-0·406	+0·070	-0·017	-0·294	+0·021	+0·012	-0·110
19	+0·295	0·245	+0·100	+0·257	0·164	0·135	+0·012
20	0·549	0·424	0·325	0·414	0·386	0·347	0·237
21		0·501	0·497		0·495	0·471	0·418
22		0·414	0·433		0·421	0·488	0·508
E		-0·266	-0·195		-0·117	-0·245	-0·206

* Incidence of centre section of wing corrected for tunnel constraint.

TABLE 35
1/3·78 scale model
36·4 deg. Sweepback
Wing Alone. Elevons Sealed
Values of C_p , Pressure Coefficient Measured on One Half of Complete Wing
Flaps 60 deg. Elevons 0 deg.

Station No.	$\alpha = 11\cdot19^*$			$\alpha = 11\cdot19^*$			
	Section			Section			
	A	B	C	D	F	G	H
1	-0·948	-2·179	-1·446	-1·619	-2·097	-1·816	-0·750
2	-1·831	-2·679	-2·447	-2·759	-2·742	-2·497	-1·825
3	-1·872	-2·592	-2·225	-2·383	-2·603	-2·449	-1·780
4	-1·950	-2·558	-2·116	-2·494	-2·706	-2·293	-1·747
5	-1·784	-1·932	-1·659	-1·880	-1·870	-1·844	-1·456
6	-1·237	-1·342	-0·924	-1·356	-1·194	-1·075	-0·746
7	-0·713	-0·776	-0·433	-0·781	-0·701	-0·609	-0·443
8	-0·379	-0·517	-0·213	-0·369	-0·429	-0·319	-0·275
9	-0·317	-0·436	-0·169	-0·256	-0·317	-0·238	-0·173
10	-0·389	-0·372	-0·160	-0·266	-0·270	-0·226	-0·133
11	-0·393	-0·313	-0·149	-0·262	-0·237	-0·213	-0·086
12	+0·576	-0·214	-0·138	+0·475	-0·202	-0·197	-0·035
13	0·457	-0·115	-0·116	0·427	-0·124	-0·172	-0·008
14	0·432	-0·024	+0·008	0·391	+0·038	+0·014	-0·009
15	0·523	-0·010	0·011	0·541	0·022	0·043	-0·023
16	0·574	+0·046	0·049	0·528	0·100	0	-0·024
17	0·391	-0·001	-0·040	0·267	0·003	0·013	-0·105
18	-0·386	+0·108	+0·006	-0·268	0·056	0·044	-0·090
19	+0·314	0·309	0·171	+0·285	0·228	0·204	+0·065
20	0·555	0·473	0·403	0·436	0·448	0·418	0·320
21		0·511	0·531		0·504	0·506	0·480
22		0·308	0·267		0·283	0·205	0·470
E		-0·265	-0·155		-0·103	-0·226	-0·159
	$\alpha = 15\cdot12^*$			$\alpha = 14\cdot93^*$			
1	-1·947	-3·679	-2·714	-2·810	-3·695	-3·262	-1·517
2	-2·696	-3·699	-3·346	-3·828	-3·822	-3·790	-2·279
3	-2·491	-3·341	-2·714	-2·963	-3·368	-3·123	-2·106
4	-2·359	-3·078	-2·306	-2·982	-3·402	-2·755	-1·740
5	-1·919	-2·198	-1·579	-2·200	-2·228	-2·094	-1·138
6	-1·338	-1·376	-0·492	-1·434	-1·271	-1·029	-0·390
7	-0·781	-0·796	-0·443	-0·747	-0·722	-0·560	-0·366
8	-0·414	-0·570	-0·448	-0·462	-0·522	-0·512	-0·367
9	-0·298	-0·495	-0·426	-0·290	-0·517	-0·485	-0·367
10	-0·336	-0·426	-0·433	-0·235	-0·455	-0·496	-0·364
11	-0·338	-0·396	-0·435	-0·229	-0·450	-0·526	-0·380
12	+0·611	-0·306	-0·429	+0·509	-0·438	-0·542	-0·367
13	0·510	-0·157	-0·412	0·480	-0·278	-0·490	-0·375
14	0·526	+0·004	-0·113	0·535	0·036	-0·040	-0·138
15	0·599	0·040	-0·056	0·571	0·036	+0·032	-0·104
16	0·550	0·107	+0·049	0·428	0·135	0·017	-0·066
17	0·071	0·053	-0·058	-0·124	0·042	0·049	-0·148
18	-0·339	0·177	+0·039	-0·241	0·115	0·108	-0·093
19	+0·348	0·401	0·262	+0·321	0·314	0·318	+0·127
20	0·599	0·494	0·497	0·577	0·506	0·505	0·406
21		0·383	0·515		0·444	0·492	0·507
22		-0·134	-0·148		-0·092	-0·263	0·335
E		-0·281	-0·370		-0·150	-0·422	-0·319

* Incidence of centre section of wing corrected for tunnel constraint.

TABLE 36
1/3·78 scale model
36·4 deg. Sweepback
Wing Alone. Elevons Sealed
Values of C_p , Pressure Coefficient Measured on One Half of Complete Wing
Flaps 60 deg. Elevons 0 deg.

Station No.	$\alpha = 16\cdot30^*$			$\alpha = 16\cdot88^*$			
	Section			Section			
	A	B	C	D	F	G	H
1	-2·238	-4·060	-2·875	-3·363	-3·958	-4·001	-1·608
2	-2·905	-3·859	-3·436	-4·218	-3·908	-3·874	-2·205
3	-2·624	-3·405	-2·605	-3·160	-3·348	-2·984	-1·902
4	-2·464	-3·103	-2·199	-3·149	-3·303	-2·645	-1·550
5	-1·993	-2·148	-1·299	-2·258	-2·039	-1·844	-0·868
6	-1·356	-1·257	-0·518	-1·345	-1·022	-0·774	-0·410
7	-0·787	-0·776	-0·499	-0·761	-0·747	-0·658	-0·398
8	-0·430	-0·588	-0·500	-0·611	-0·675	-0·642	-0·402
9	-0·308	-0·521	-0·475	-0·422	-0·634	-0·619	-0·402
10	-0·339	-0·466	-0·477	-0·296	-0·595	-0·627	-0·403
11	-0·342	-0·438	-0·477	-0·299	-0·597	-0·627	-0·423
12	+0·615	-0·371	-0·472	+0·519	-0·577	-0·609	-0·420
13	0·524	-0·232	-0·451	0·494	-0·402	-0·541	-0·437
14	0·544	-0·013	-0·139	0·556	-0·022	-0·100	-0·167
15	0·607	+0·027	-0·073	0·581	+0·001	-0·009	-0·118
16	0·524	0·104	+0·037	0·364	0·126	-0·017	-0·073
17	-0·054	0·051	-0·066	-0·311	0·024	+0·026	-0·150
18	-0·339	0·185	+0·037	-0·302	0·115	0·099	-0·087
19	+0·350	0·423	0·273	+0·312	0·333	0·328	+0·142
20	0·597	0·490	0·499	0·487	0·515	0·518	0·421
21		0·330	0·503		0·425	0·484	0·504
22		-0·299	-0·228		0·078	-0·353	0·305
E		-0·295	-0·302		-0·201	-0·536	-0·354
	$\alpha = 21\cdot15^*$			$\alpha = 21\cdot05^*$			
1	-3·247	-2·799	-2·219	-3·870	-3·078	-2·577	-1·710
2	-3·736	-2·462	-2·609	-4·359	-2·829	-2·758	-2·139
3	-2·833	-1·869	-1·745	-3·127	-2·190	-1·805	-1·581
4	-2·725	-1·340	-1·245	-2·796	-1·824	-1·291	-1·317
5	-2·053	-0·859	-0·526	-1·430	-0·762	-0·594	-0·587
6	-1·218	-0·729	-0·473	-0·784	-0·646	-0·550	-0·405
7	-0·717	-0·666	-0·482	-0·836	-0·652	-0·560	-0·404
8	-0·701	-0·664	-0·478	-0·827	-0·657	-0·562	-0·413
9	-0·671	-0·593	-0·453	-0·788	-0·600	-0·541	-0·415
10	-0·564	-0·601	-0·460	-0·563	-0·611	-0·552	-0·410
11	-0·563	-0·607	-0·463	-0·566	-0·622	-0·550	-0·429
12	+0·627	-0·573	-0·462	+0·512	-0·611	-0·541	-0·423
13	0·556	-0·608	-0·439	0·500	-0·557	-0·518	-0·441
14	0·606	-0·213	-0·152	0·591	-0·174	-0·162	-0·189
15	0·635	-0·115	-0·093	0·589	-0·122	-0·068	-0·127
16	0·434	-0·009	+0·031	0·320	+0·045	-0·073	-0·072
17	-0·456	-0·056	-0·091	-0·496	-0·070	-0·023	-0·151
18	-0·563	+0·118	+0·025	-0·579	+0·053	+0·058	-0·081
19	+0·308	0·396	0·262	+0·246	0·309	0·311	+0·165
20	0·629	0·506	0·493	0·498	0·519	0·512	0·432
21		0·436	0·513		0·466	0·510	0·487
22		0·027	-0·078		-0·017	-0·127	0·243
E		-0·393	-0·397		-0·240	-0·479	-0·365

* Incidence of centre section of wing corrected for tunnel constraint.

TABLE 37
 1/3·78 scale model
 36·4 deg. Sweepback
 Wing Alone. Elevons Sealed
 Values of C_p , Pressure Coefficient Measured on One Half of Complete Wing
 Flaps 60 deg. Elevons 0 deg.

Station No.	$\alpha = 25\cdot15^*$						
	Section						
	A	B	C	D	F	G	H
1	-4·356	-3·029	-2·465	-4·624	-3·343	-2·604	-1·903
2	-4·666	-2·269	-2·655	-4·773	-2·557	-2·381	-1·989
3	-3·364	-1·574	-1·430	-3·153	-1·792	-1·204	-1·254
4	-2·937	-1·043	-0·766	-2·529	-1·053	-0·645	-0·830
5	-2·018	-0·830	-0·464	-1·061	-0·660	-0·551	-0·457
6	-0·998	-0·693	-0·466	-0·868	-0·610	-0·510	-0·425
7	-0·978	-0·670	-0·471	-0·877	-0·606	-0·527	-0·429
8	-0·896	-0·664	-0·482	-0·848	-0·616	-0·529	-0·434
9	-0·797	-0·627	-0·458	-0·832	-0·564	-0·511	-0·429
10	-0·606	-0·617	-0·462	-0·635	-0·574	-0·515	-0·420
11	-0·586	-0·621	-0·464	-0·641	-0·575	-0·516	-0·432
12	+0·655	-0·630	-0·458	+0·553	-0·566	-0·508	-0·403
13	0·602	-0·705	-0·442	0·547	-0·545	-0·495	-0·419
14	0·656	-0·233	-0·149	0·633	-0·169	-0·143	-0·185
15	0·634	-0·108	-0·077	0·566	-0·111	-0·044	-0·113
16	0·281	+0·007	+0·052	0·163	+0·072	-0·043	-0·048
17	-0·970	-0·029	-0·063	-0·922	-0·042	+0·017	-0·122
18	-0·591	+0·156	+0·066	-0·657	+0·101	0·108	-0·034
19	+0·324	0·445	0·320	+0·258	0·363	0·372	+0·223
20	0·681	0·500	0·525	0·533	0·539	0·549	0·474
21		0·352	0·493		0·429	0·500	0·468
22		-0·173	-0·219		-0·231	-0·250	0·137
E		-0·395	-0·397		-0·216	-0·442	-0·369

* Incidence of centre section of wing corrected for tunnel constraint.

TABLE 38
1/3·78 scale model
36·4 deg. Sweepback
Wing Alone. Elevons Sealed
Values of C_p , Pressure Coefficient Measured on One Half of Complete Wing
Flaps 60 deg. Elevons - 10 deg.

Station No.	$\alpha = 5\cdot38^*$			$\alpha = 5\cdot38^*$			
	Section			Section			
	A	B	C	D	F	G	H
1	+0·131	-0·366	+0·285	-0·112	-0·096	-0·099	+0·500
2	-0·750	-1·127	-0·741	-1·281	-1·047	-0·940	-0·335
3	-0·999	-1·380	-0·894	-1·303	-1·234	-1·088	-0·558
4	-1·253	-1·579	-1·038	-1·593	-1·600	-1·226	-0·753
5	-1·285	-1·376	-1·009	-1·419	-1·269	-1·179	-0·768
6	-1·025	-0·990	-0·587	-1·105	-0·779	-0·701	-0·426
7	-0·646	-0·501	-0·274	-0·649	-0·417	-0·376	-0·192
8	-0·341	-0·247	-0·058	-0·298	-0·180	-0·115	-0·024
9	-0·331	-0·065	+0·110	-0·255	-0·041	+0·038	+0·108
10	-0·483	-0·036	0·115	-0·365	+0·008	0·056	0·169
11	-0·495	-0·049	0·109	-0·363	0·016	0·071	0·160
12	+0·513	-0·026	0·116	+0·415	0·040	0·097	0·148
13	0·349	-0·050	0·111	0·324	0·060	0·107	0·111
14	0·234	-0·157	0·018	0·275	-0·001	0·004	0·041
15	0·308	-0·196	-0·108	0·373	-0·106	-0·096	-0·087
16	0·421	-0·477	-0·458	0·479	-0·538	-0·544	-0·465
17	0·531	-0·185	-0·293	0·533	-0·253	-0·236	-0·280
18	-0·486	-0·077	-0·211	-0·368	-0·173	-0·197	-0·252
19	+0·244	+0·103	-0·159	+0·229	-0·028	-0·094	-0·215
20	0·496	0·253	+0·019	0·363	+0·185	+0·095	-0·069
21		0·382	0·334		0·352	0·245	+0·053
22		0·482	0·464		0·501	0·500	0·272
E		-0·168	-0·249		-0·161	-0·180	-0·220
	$\alpha = 9\cdot29^*$			$\alpha = 9\cdot09^*$			
1	-0·471	-1·331	-0·438	-0·906	-1·069	-0·814	+0·720
2	-1·401	-1·994	-1·546	-2·137	-1·938	-1·820	-1·029
3	-1·522	-2·051	-1·539	-1·927	-1·946	-1·766	-1·142
4	-1·674	-2·115	-1·555	-2·128	-2·168	-1·761	-1·229
5	-1·583	-1·757	-1·350	-1·696	-1·642	-1·549	-1·079
6	-1·146	-1·125	-0·727	-1·250	-0·943	-0·848	-0·525
7	-0·705	-0·567	-0·348	-0·707	-0·483	-0·441	-0·260
8	-0·368	-0·282	-0·098	-0·333	-0·215	-0·155	-0·062
9	-0·332	-0·174	+0·006	-0·263	-0·124	-0·067	+0·063
10	-0·450	-0·156	0·051	-0·328	-0·111	-0·033	0·131
11	-0·451	-0·118	0·064	-0·325	-0·073	+0·001	0·124
12	+0·551	-0·068	0·079	+0·448	-0·015	0·045	0·119
13	0·416	-0·053	0·102	0·381	+0·045	0·081	0·081
14	0·359	-0·117	0·028	0·392	0·012	0·014	0·014
15	0·461	-0·150	-0·074	0·494	-0·072	-0·064	-0·094
16	0·544	-0·433	-0·405	0·545	-0·429	-0·456	-0·431
17	0·491	-0·133	-0·229	0·434	-0·182	-0·163	-0·259
18	-0·449	+0·003	-0·121	-0·334	-0·088	-0·102	-0·195
19	+0·276	0·210	+0·014	+0·255	+0·111	+0·065	-0·071
20	0·531	0·401	0·253	0·405	0·352	0·300	+0·157
21		0·479	0·448		0·481	0·443	0·349
22		0·429	0·493		0·455	0·444	0·504
E		-0·198	-0·175		-0·188	-0·157	-0·213

* Incidence of centre section of wing corrected for tunnel constraint.

TABLE 39
1/3·78 scale model
36·4 deg. Sweepback
Wing Alone. Elevons Sealed
Values of C_p , Pressure Coefficient Measured on One Half of Complete Wing
Flaps 60 deg. Elevons -10 deg.

Station No.	$\alpha = 11\cdot34^*$			$\alpha = 11\cdot34^*$			
	Section			Section			
	A	B	C	D	F	G	H
1	-0.924	-2.059	-1.073	-1.506	-1.837	-1.502	-0.419
2	-1.815	-2.579	-2.107	-2.712	-2.532	-2.415	-1.509
3	-1.849	-2.486	-1.935	-2.339	-2.408	-2.212	-1.524
4	-1.920	-2.454	-1.876	-2.451	-2.525	-2.096	-1.534
5	-1.765	-1.821	-1.499	-1.846	-1.732	-1.701	-1.280
6	-1.208	-1.193	-0.766	-1.331	-1.025	-0.902	-0.606
7	-0.729	-0.600	-0.312	-0.726	-0.496	-0.417	-0.290
8	-0.378	-0.319	-0.113	-0.348	-0.258	-0.187	-0.084
9	-0.321	-0.251	-0.086	-0.264	-0.194	-0.153	+0.025
10	-0.411	-0.211	-0.061	-0.307	-0.189	-0.142	0.083
11	-0.416	-0.176	-0.029	-0.307	-0.157	-0.108	0.085
12	+0.573	-0.105	+0.014	+0.470	-0.086	-0.051	0.090
13	0.452	-0.051	0.072	0.417	+0.023	+0.030	0.061
14	0.426	-0.091	0.026	0.426	0.016	0.014	-0.001
15	0.521	-0.118	-0.062	0.540	-0.053	-0.049	-0.100
16	0.576	-0.382	-0.355	0.535	-0.382	-0.416	-0.417
17	0.390	-0.097	-0.195	0.294	-0.151	-0.134	-0.246
18	-0.410	+0.054	-0.073	-0.318	-0.042	-0.051	-0.166
19	+0.301	0.280	+0.103	+0.273	+0.179	+0.146	+0.002
20	0.550	0.465	0.359	0.430	0.424	0.384	0.264
21		0.507	0.517		0.504	0.498	0.445
22		0.313	0.366		0.337	0.302	0.508
E		-0.124	-0.204		-0.185	-0.154	-0.216
	$\alpha = 15\cdot15^*$			$\alpha = 15\cdot24^*$			
1	-1.974	-3.633	-2.315	-2.774	-3.416	-2.906	-1.195
2	-2.737	-3.688	-3.054	-3.773	-3.632	-3.496	-2.044
3	-2.548	-3.321	-2.621	-2.944	-3.230	-2.975	-1.898
4	-2.394	-3.068	-2.155	-2.872	-3.245	-2.563	-1.655
5	-1.955	-2.171	-1.468	-2.180	-2.089	-1.895	-1.084
6	-1.363	-1.345	-0.425	-1.418	-1.105	-0.801	-0.328
7	-0.768	-0.680	-0.362	-0.736	-0.575	-0.486	-0.300
8	-0.407	-0.463	-0.362	-0.445	-0.492	-0.464	-0.299
9	-0.305	-0.418	-0.350	-0.297	-0.440	-0.442	-0.295
10	-0.358	-0.326	-0.359	-0.275	-0.434	-0.465	-0.281
11	-0.357	-0.278	-0.360	-0.272	-0.428	-0.477	-0.269
12	+0.612	-0.171	-0.349	+0.500	-0.316	-0.442	-0.215
13	0.512	-0.048	-0.312	0.472	-0.043	-0.314	-0.137
14	0.524	-0.051	-0.132	0.528	+0.027	-0.056	-0.094
15	0.597	-0.065	-0.155	0.572	-0.028	-0.063	-0.167
16	0.550	-0.331	-0.390	0.436	-0.301	-0.388	-0.484
17	0.072	-0.046	-0.214	-0.097	-0.095	-0.083	-0.283
18	-0.357	+0.134	-0.037	-0.282	+0.031	+0.020	-0.156
19	+0.339	0.384	+0.209	+0.306	0.280	0.273	+0.057
20	0.600	0.481	0.469	0.468	0.499	0.486	0.376
21		0.402	0.541		0.463	0.508	0.505
22		-0.070	0.019		-0.008	-0.047	0.367
E		-0.102	-0.301		-0.129	-0.214	-0.325

* Incidence of centre section of wing corrected for tunnel constraint.

TABLE 40
 1/3·78 scale model
 36·4 deg. Sweepback
 Wing Alone. Elevons Sealed
 Values of C_p , Pressure Coefficient Measured on One Half of Complete Wing
 Flaps 60 deg. Elevons — 10 deg.

Station No.	$\alpha = 17\cdot13^*$						
	Section						
	A	B	C	D	F	G	H
1	-2·466	-4·004	-2·561	-3·308	-3·687	-3·196	-1·339
2	-3·116	-3·764	-3·140	-4·198	-3·688	-3·617	-2·052
3	-2·737	-3·269	-2·405	-3·094	-3·178	-2·850	-1·869
4	-2·539	-2·924	-1·949	-3·091	-3·119	-2·481	-1·500
5	-2·052	-1·955	-1·013	-2·191	-1·897	-1·689	-0·876
6	-1·383	-1·111	-0·474	-1·231	-0·950	-0·682	-0·359
7	-0·756	-0·736	-0·427	-0·776	-0·682	-0·608	-0·370
8	-0·444	-0·624	-0·432	-0·606	-0·614	-0·596	-0·389
9	-0·348	-0·552	-0·413	-0·399	-0·559	-0·565	-0·387
10	-0·376	-0·489	-0·425	-0·301	-0·544	-0·590	-0·386
11	-0·384	-0·452	-0·425	-0·304	-0·530	-0·593	-0·396
12	+0·621	-0·358	-0·419	+0·515	-0·398	-0·547	-0·357
13	0·534	-0·217	-0·386	0·492	-0·130	-0·427	-0·282
14	0·561	-0·093	-0·188	0·556	-0·010	-0·117	-0·151
15	0·618	-0·092	-0·214	0·570	-0·049	-0·097	-0·206
16	0·524	-0·372	-0·427	0·369	-0·333	-0·422	-0·491
17	-0·103	-0·059	-0·246	-0·312	-0·103	-0·079	-0·304
18	-0·378	+0·128	-0·048	-0·310	+0·043	+0·027	-0·160
19	+0·344	0·400	+0·223	+0·305	0·305	0·300	+0·103
20	0·612	0·494	0·480	0·480	0·506	0·503	0·399
21		0·373	0·521		0·425	0·471	0·502
22		-0·190	-0·063		0·155	-0·306	0·356
E		-0·146	-0·334		-0·149	-0·248	-0·366
	$\alpha = 21\cdot18^*$						
1	-3·238	-2·709	-2·115	-3·769	-2·918	-2·468	-1·544
2	-3·699	-2·400	-2·565	-4·325	-2·728	-2·704	-2·036
3	-2·928	-1·794	-1·747	-3·047	-2·123	-1·819	-1·609
4	-2·721	-1·242	-1·284	-2·705	-1·777	-1·342	-1·309
5	-2·040	-0·809	-0·509	-1·320	-0·753	-0·601	-0·600
6	-1·198	-0·682	-0·450	-0·758	-0·635	-0·552	-0·383
7	-0·702	-0·687	-0·450	-0·796	-0·643	-0·553	-0·387
8	-0·711	-0·693	-0·461	-0·791	-0·644	-0·551	-0·401
9	-0·680	-0·592	-0·439	-0·760	-0·579	-0·522	-0·399
10	-0·566	-0·612	-0·452	-0·555	-0·607	-0·541	-0·402
11	-0·565	-0·626	-0·452	-0·553	-0·622	-0·546	-0·424
12	+0·633	-0·604	-0·459	+0·515	-0·613	-0·538	-0·402
13	0·553	-0·605	-0·435	0·499	-0·531	-0·501	-0·365
14	0·612	-0·284	-0·237	0·588	-0·241	-0·241	-0·200
15	0·638	-0·238	-0·251	0·592	-0·231	-0·221	-0·235
16	0·439	-0·535	-0·499	0·334	-0·585	-0·602	-0·526
17	-0·441	-0·159	-0·292	-0·461	-0·232	-0·185	-0·319
18	-0·565	+0·067	-0·063	-0·568	-0·034	-0·035	-0·152
19	+0·309	0·374	+0·218	+0·242	+0·279	+0·272	+0·125
20	0·635	0·507	0·477	0·492	0·509	0·498	0·421
21		0·460	0·528		0·472	0·514	0·506
22		0·078	-0·014		0·029	-0·077	0·311
E		-0·238	-0·399		-0·330	-0·326	-0·388

* Incidence of centre section of wing corrected for tunnel constraint.

TABLE 41
1/3·78 scale model
36·4 deg. Sweepback
Wing Alone. Elevons Sealed
Values of C_p , Pressure Coefficient Measured on One Half of Complete Wing
Flaps 60 deg. Elevons -10 deg.

Station No.	$\alpha = 25\cdot58^*$			$\alpha = 25\cdot38^*$			
	Section			Section			
	A	B	C	D	F	G	H
1	-4·376	-2·888	-2·395	-4·438	-3·278	-2·605	-1·884
2	-4·602	-2·134	-2·625	-4·548	-2·549	-2·504	-2·066
3	-3·277	-1·427	-1·469	-2·969	-1·795	-1·297	-1·324
4	-2·791	-0·953	-0·808	-2·324	-1·097	-0·712	-0·915
5	-1·688	-0·794	-0·467	-1·027	-0·666	-0·569	-0·428
6	-1·021	-0·693	-0·466	-0·843	-0·634	-0·531	-0·412
7	-1·017	-0·667	-0·472	-0·807	-0·637	-0·537	-0·404
8	-0·914	-0·666	-0·472	-0·778	-0·613	-0·540	-0·418
9	-0·814	-0·625	-0·448	-0·769	-0·540	-0·500	-0·405
10	-0·622	-0·625	-0·460	-0·620	-0·570	-0·523	-0·404
11	-0·612	-0·632	-0·464	-0·619	-0·582	-0·525	-0·428
12	+0·664	-0·635	-0·458	+0·538	-0·572	-0·512	-0·403
13	0·614	-0·702	-0·443	0·544	-0·525	-0·496	-0·410
14	0·669	-0·304	-0·248	0·630	-0·252	-0·243	-0·241
15	0·644	-0·233	-0·250	0·572	-0·236	-0·199	-0·250
16	0·288	-0·544	-0·481	0·194	-0·573	-0·580	-0·515
17	-0·958	-0·130	-0·264	-0·831	-0·207	-0·148	-0·298
18	-0·611	+0·118	-0·023	-0·632	+0·013	+0·013	-0·113
19	+0·325	0·430	+0·286	+0·289	0·333	0·336	+0·188
20	0·695	0·502	0·519	0·530	0·531	0·535	0·467
21		0·365	0·501		0·435	0·500	0·492
22		-0·138	-0·202		-0·121	-0·204	0·181
E		-0·225	-0·384		-0·320	-0·300	-0·378

* Incidence of centre section of wing corrected for tunnel constraint.

TABLE 42
1/3·78 scale model
36·4 deg. Sweepback
Wing Alone. Elevons Sealed
Spanwise Local Lift Coefficients obtained from Pressure Plotting tests

Incidence* deg.	Section†							
	A	D	B	F	G	C	H	centre line
2	0·256	0·280	0·290	0·292	0·290	0·250	0·146	0·236
4	0·395	0·425	0·442	0·445	0·440	0·395	0·280	0·360
6	0·532	0·570	0·594	0·594	0·579	0·528	0·398	0·481
8	0·652	0·705	0·720	0·720	0·701	0·643	0·505	0·591
10	0·780	0·848	0·844	0·842	0·807	0·753	0·605	0·699
12	0·900	0·985	0·959	0·930	0·875	0·792	0·645	0·803
14	1·011	1·122	1·059	1·008	0·918	0·762	0·586	0·895
16	1·119	1·250	1·143	1·068	0·927	0·685	0·591	0·983
18	1·219	1·372	1·218	1·082	0·798	0·625	0·478	1·070
20	1·308	1·496	1·264	1·140	0·873	0·677	0·529	1·142
22	1·397	1·612	1·265	1·025	0·763	0·649	0·547	1·219
24	1·468	1·640	1·018	0·876	0·741	0·637	0·535	1·310
26	1·544	1·590	0·995	0·846	0·758	0·641	0·512	1·408
28	1·586	1·465	0·959	0·836	0·737	0·607	0·489	1·499

* The incidence given is the uncorrected root chord incidence.

† For the positions of the sections see Fig. 58.

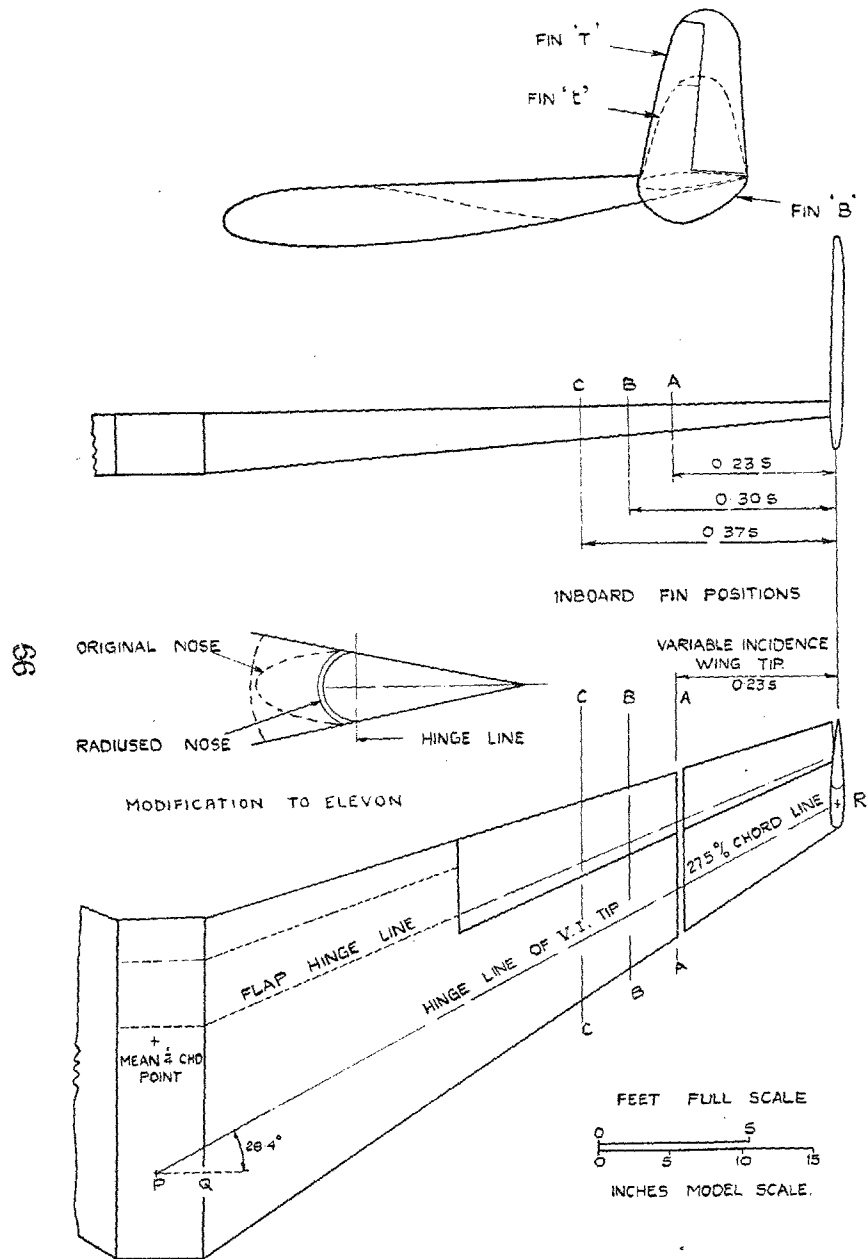

FIG. 1. "V" wing. 28.4 deg. sweepback. 1/5.67 scale model.

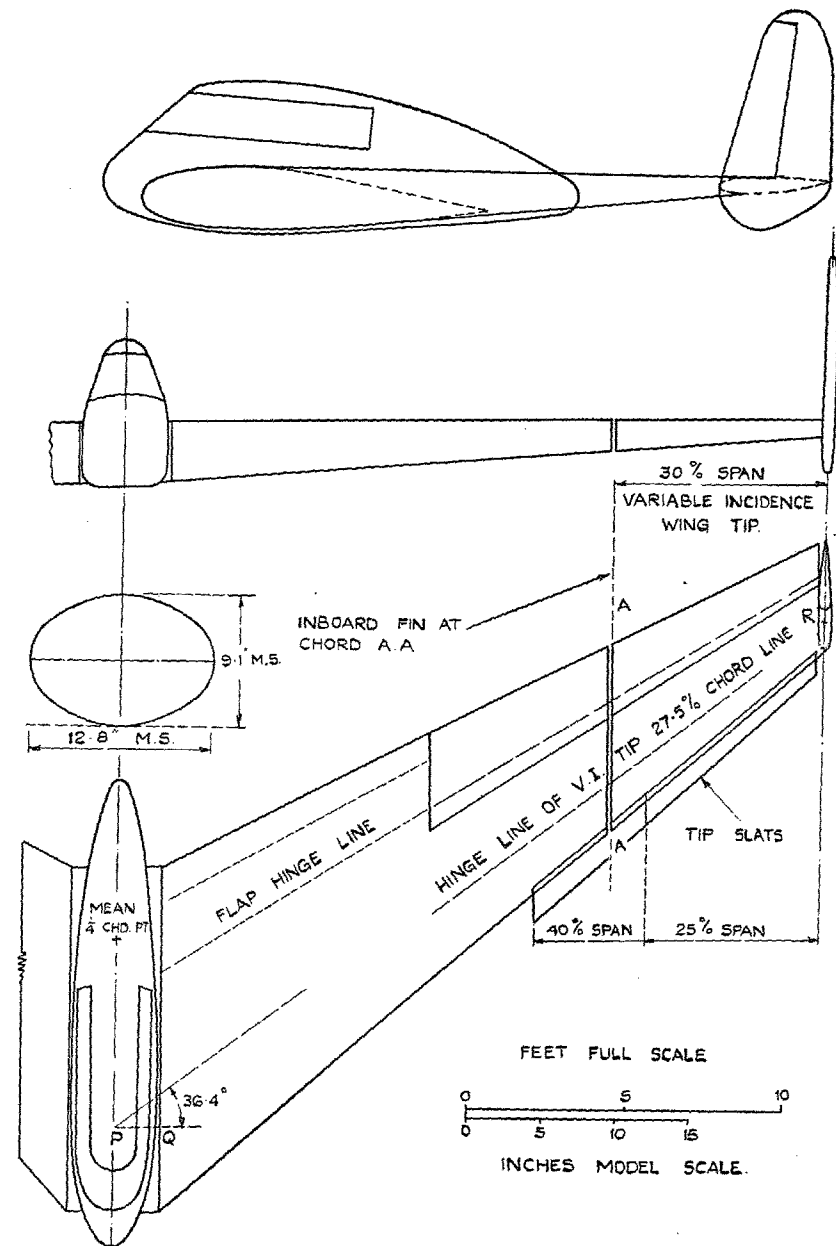
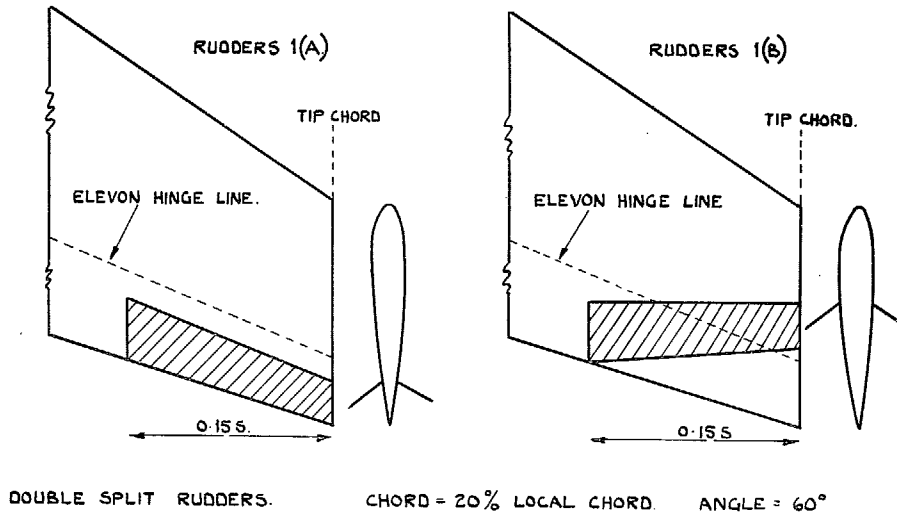

FIG. 2. "V" wing. 36.4 deg. sweepback. 1/5.67 scale model.



67

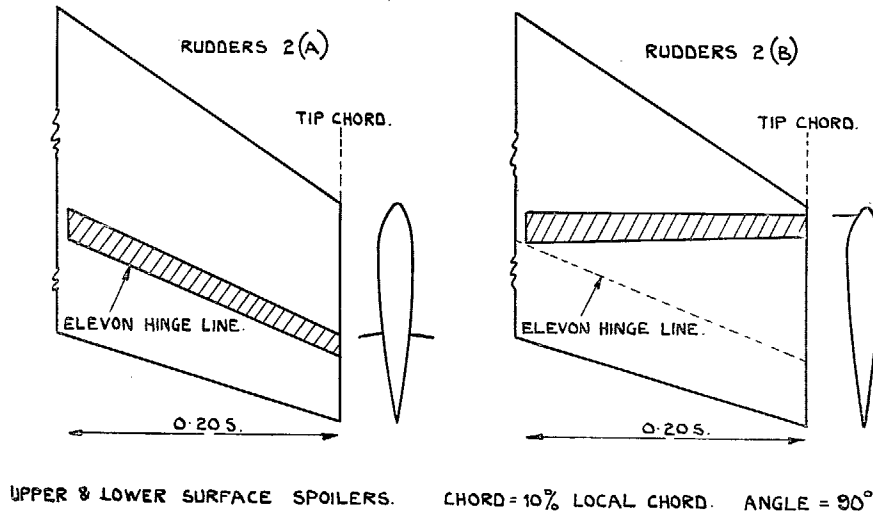

FIG. 3. "V" wing. 28.4 deg. sweepback. Drag rudders.

E*

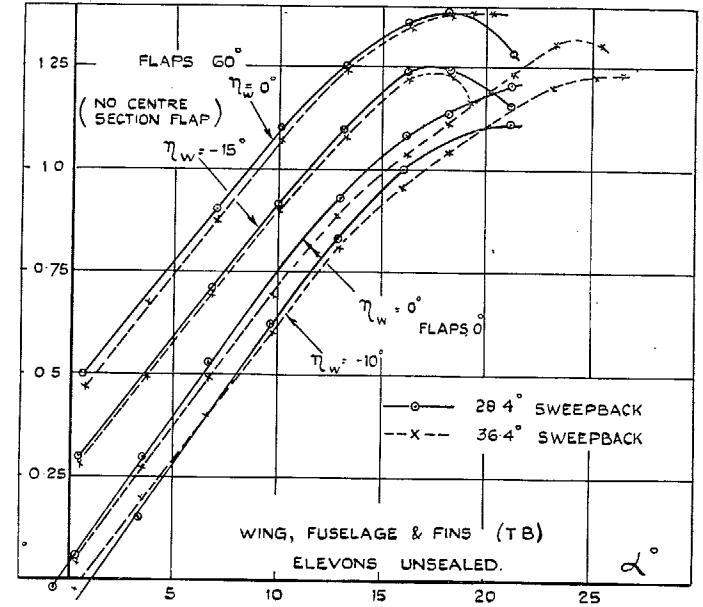
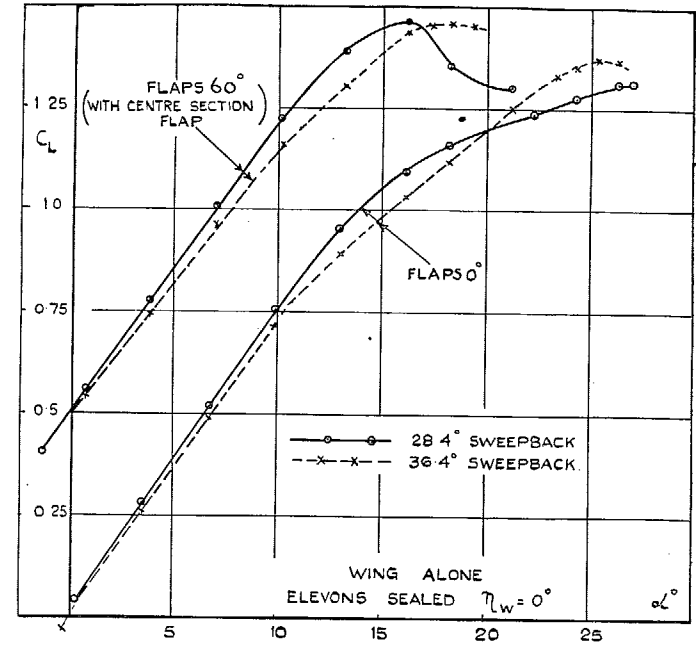

FIG. 4. Lift coefficients.

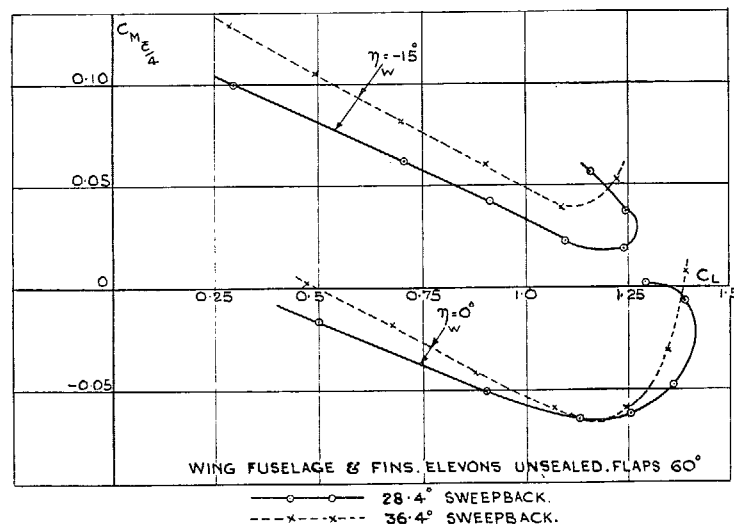
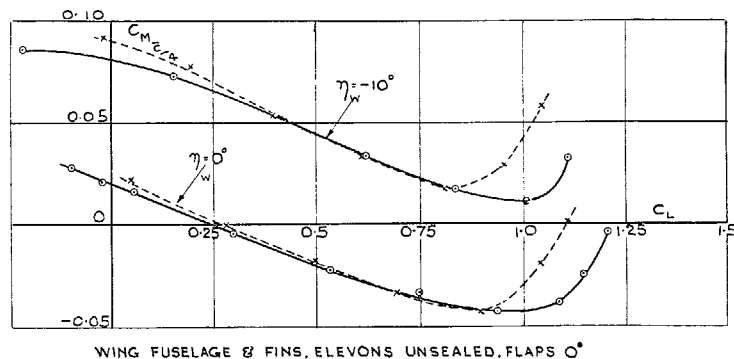
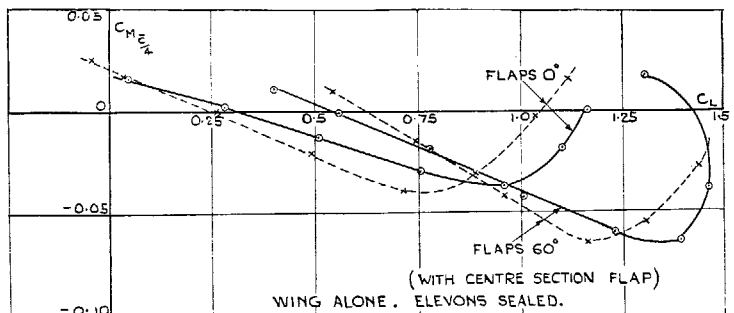

FIG. 5. Pitching moments.

Note: Bottom graph. After FLAPS 60° read NO CENTRE SECTION FLAP.

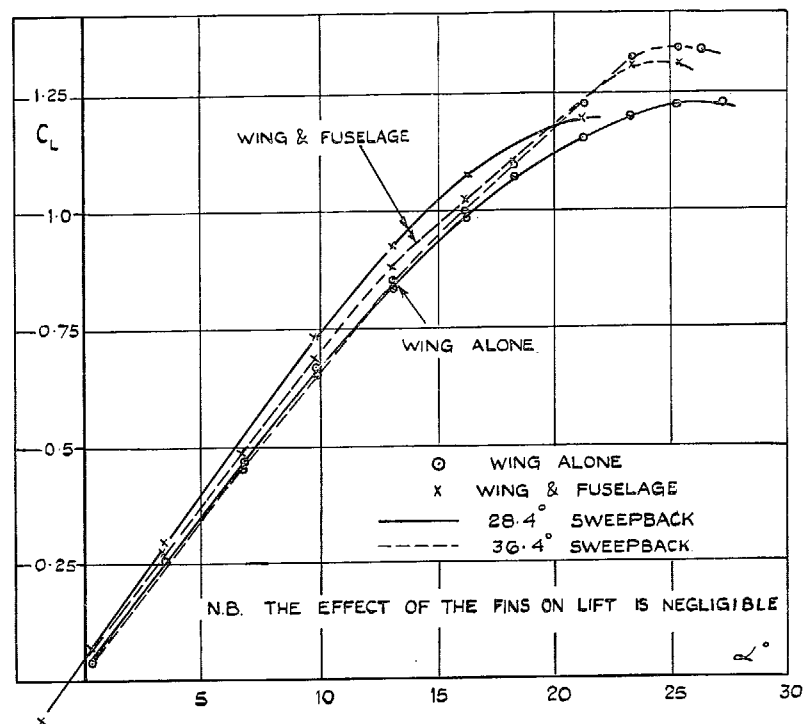

FIG. 6. Lift coefficients.

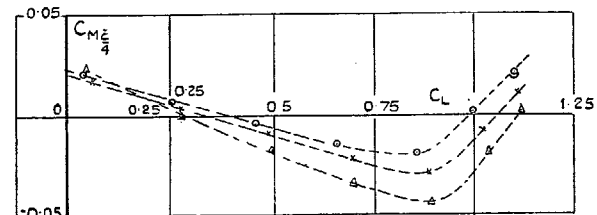
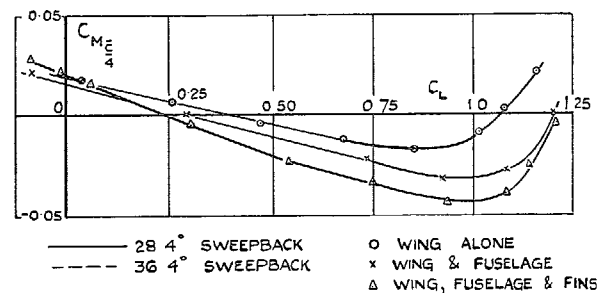

FIG. 7. Pitching moments.

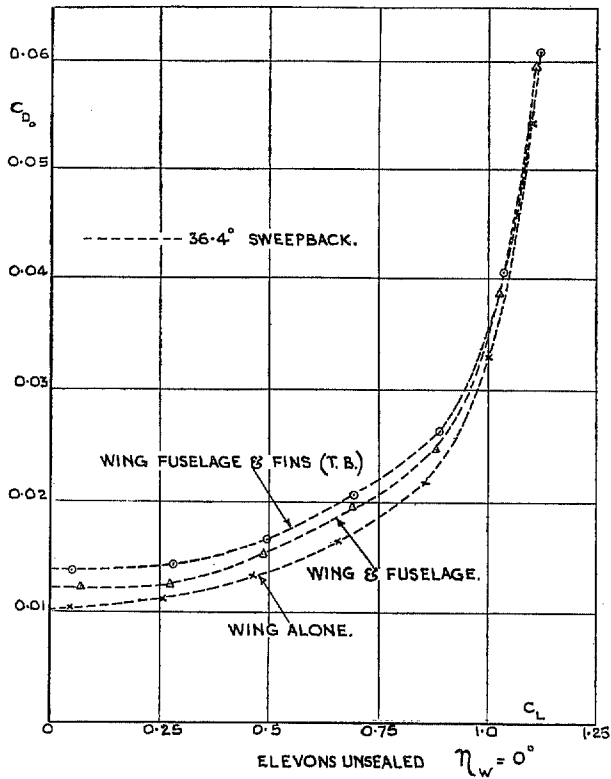

FIG. 8. Effect of fuselage and fins.

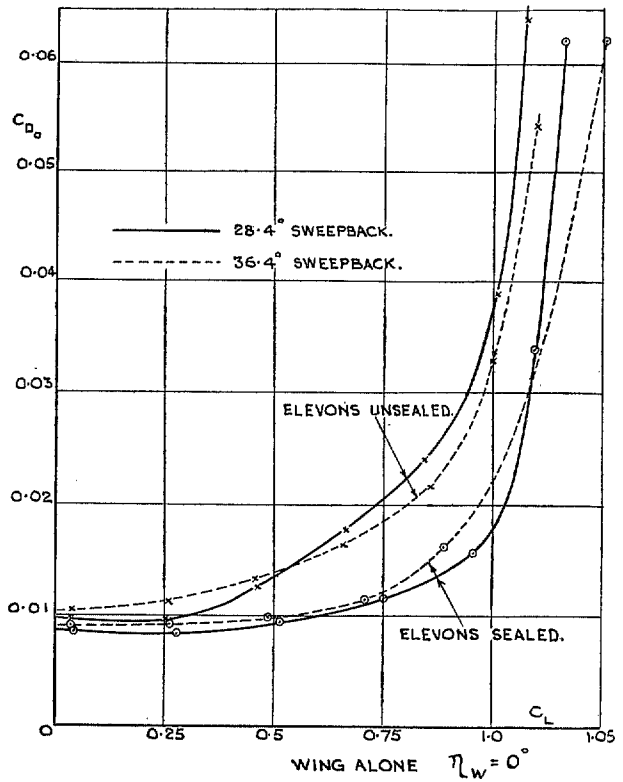

FIG. 9. Effect of elevon sealing.

FIGS. 8 and 9. Profile drag coefficients.

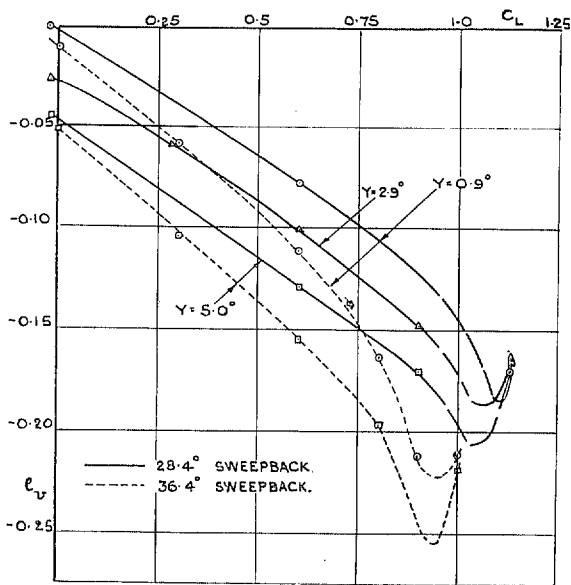

FIG. 10. Wing alone. Flaps 0 deg.

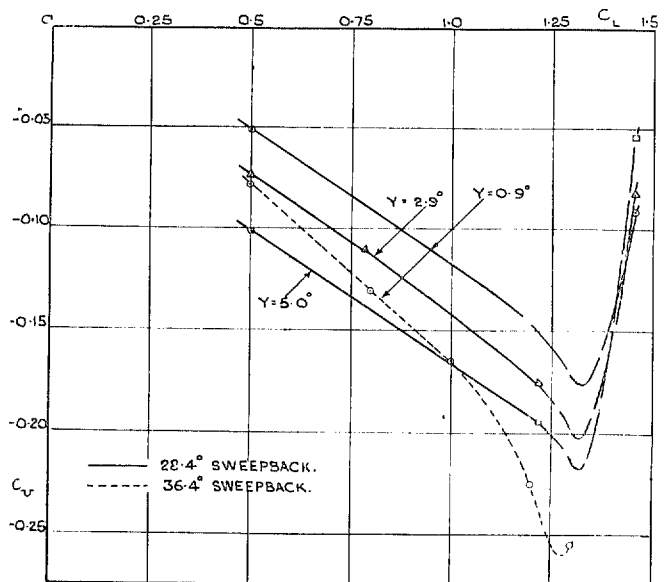

FIG. 11. Wing alone. Flaps 60 deg. (with centre section flap)

FIGS. 10 and 11. Effect of dihedral on C_{D_i} .

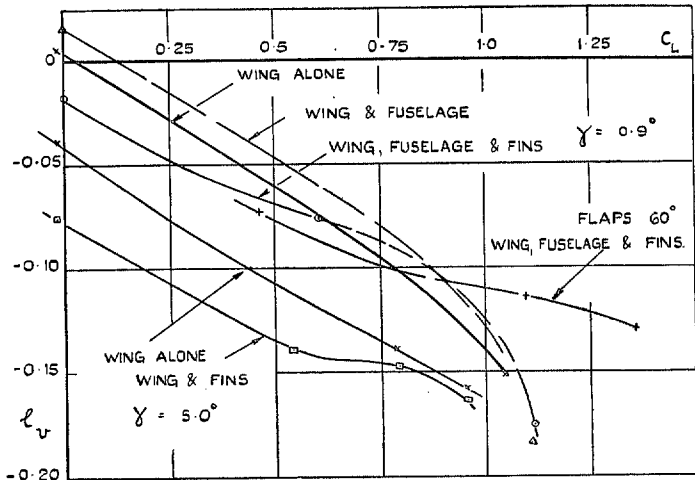

FIG. 12. 28.4° Sweepback $\gamma = 0.9^\circ$ and 5.0° .

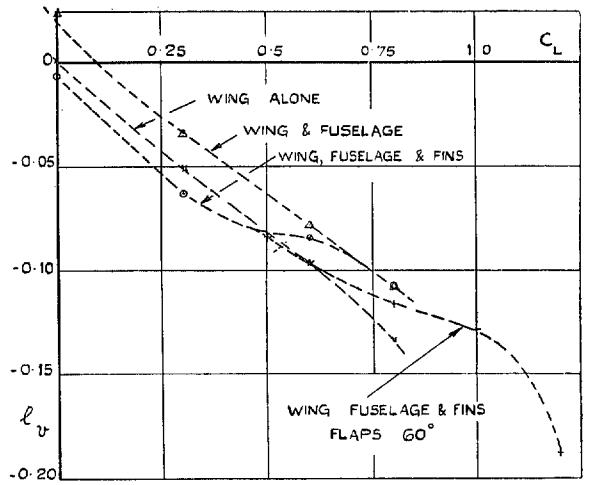
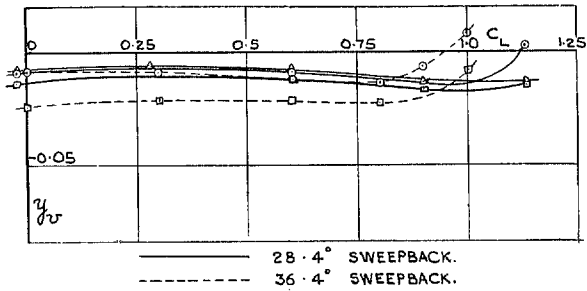
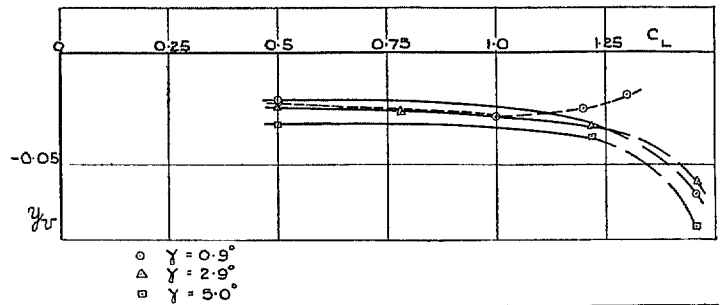

FIG. 13. 36.4° Sweepback $\gamma = 0.9^\circ$.

FIGS. 12 and 13. Effect of fuselage and fins on l_v .



— 28.4° SWEEPBACK.
- - - 36.4° SWEEPBACK.



○ $\gamma = 0.9^\circ$
△ $\gamma = 2.9^\circ$
□ $\gamma = 5.0^\circ$

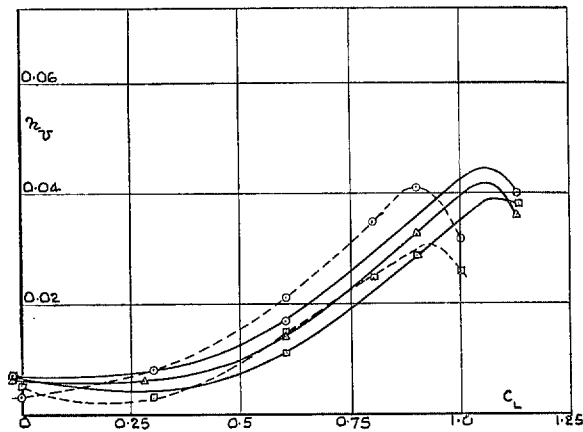

FIG. 14. Wing alone. Flaps 0 deg.

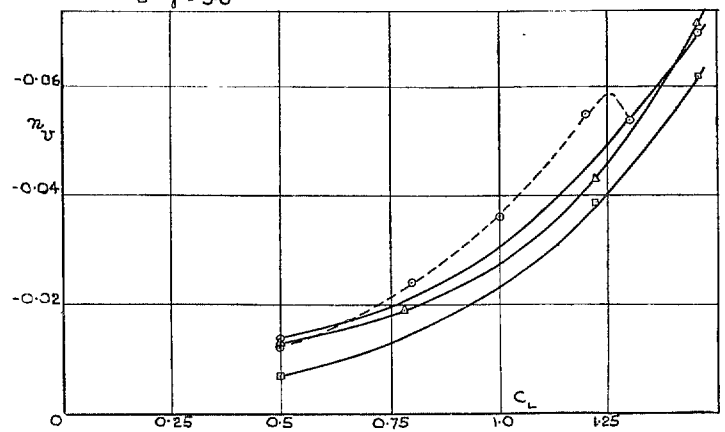

FIG. 15. Wing alone. Flaps 60 deg. (With centre section flap.)

FIGS. 14 and 15. Effect of dihedral on n_v and y_v .

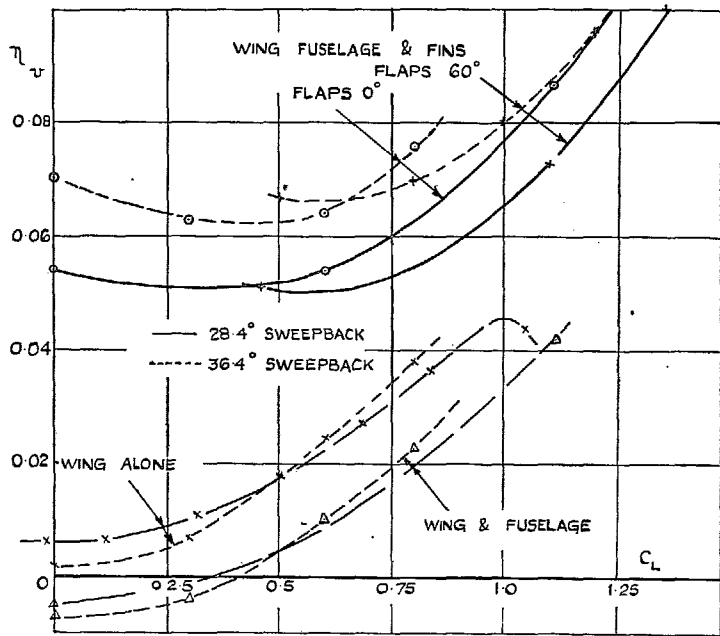

FIG. 16. Effect of fuselage and fins on n_v .

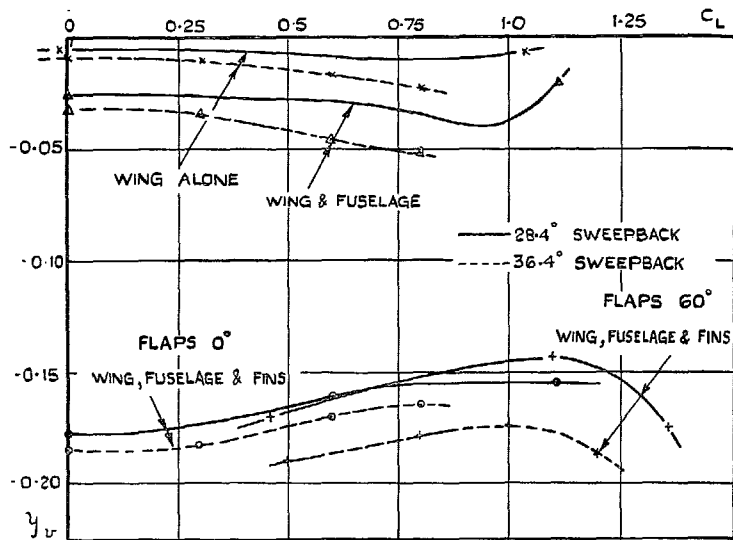

FIG. 17. Effect of fuselage and fins on y_v .

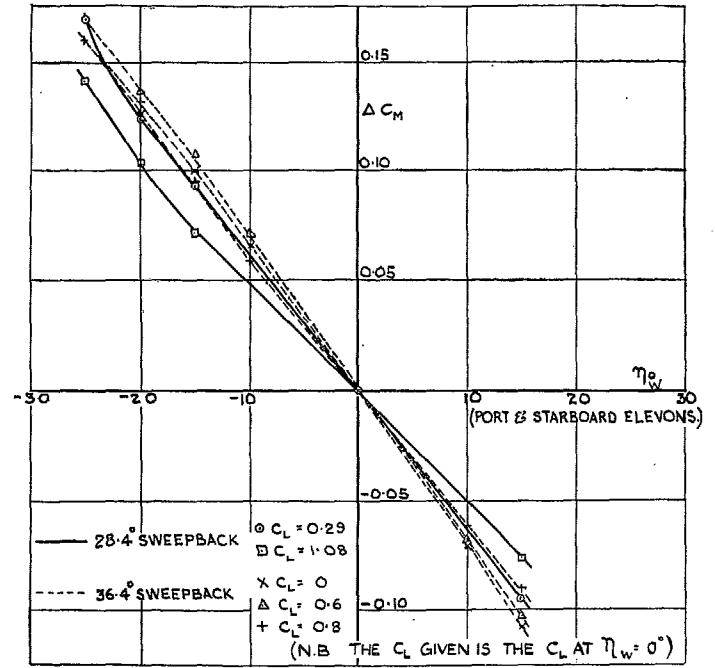

FIG. 18. Pitching moments—Elevons unsealed. Flaps 0 deg.

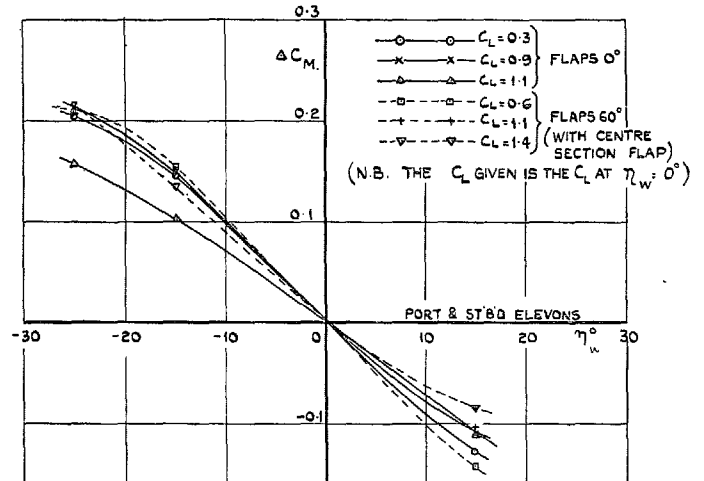

FIG. 19. Pitching moments—Elevons sealed. 28.4 deg. sweepback.

FIGS. 18 and 19. Elevon power.

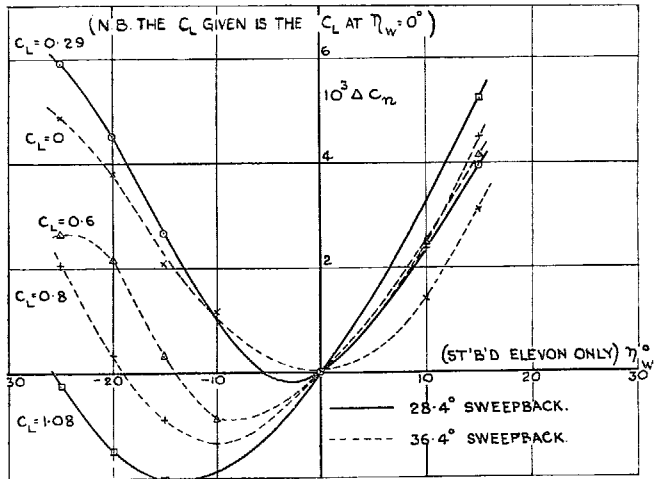

FIG. 20. Yawing moments—Elevons unsealed. Flaps 0 deg.

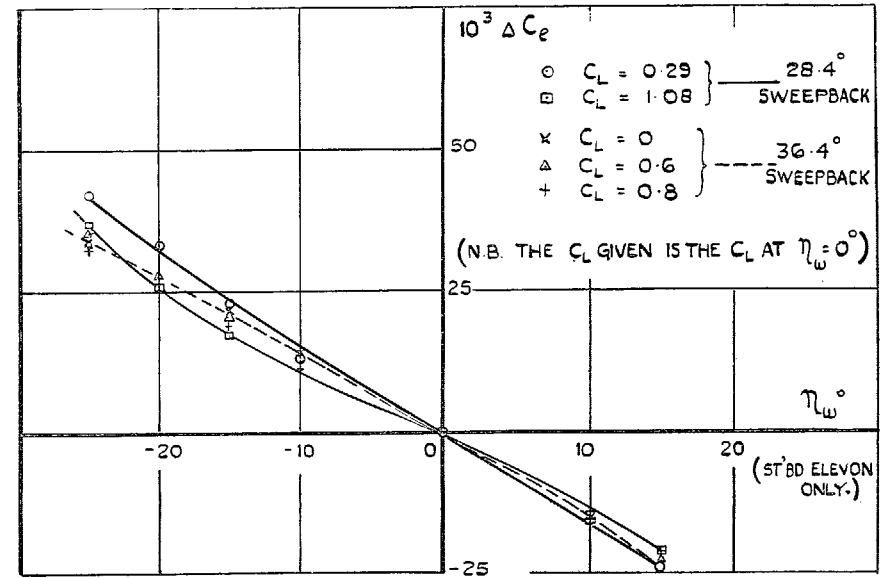

FIG. 22. Rolling moments—Elevons unsealed. Flaps 0 deg.

72

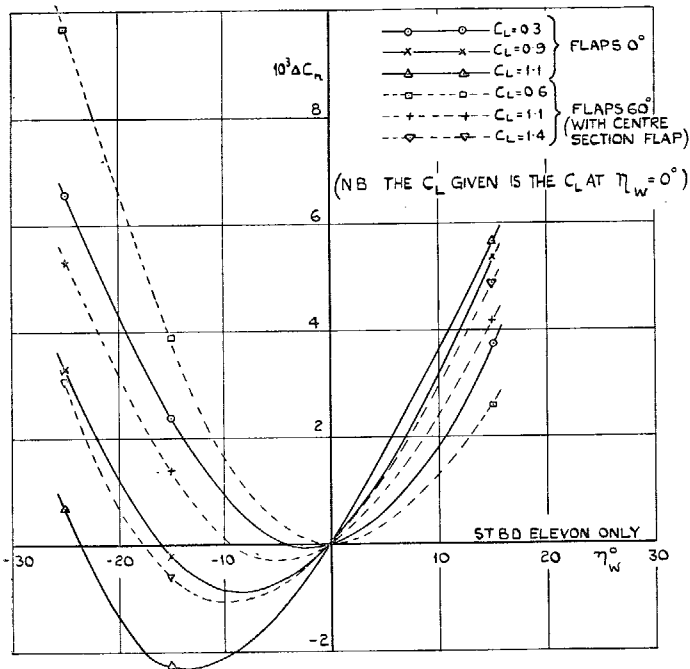

FIG. 21. Yawing moments—Elevons sealed. 28.4 deg. sweepback.

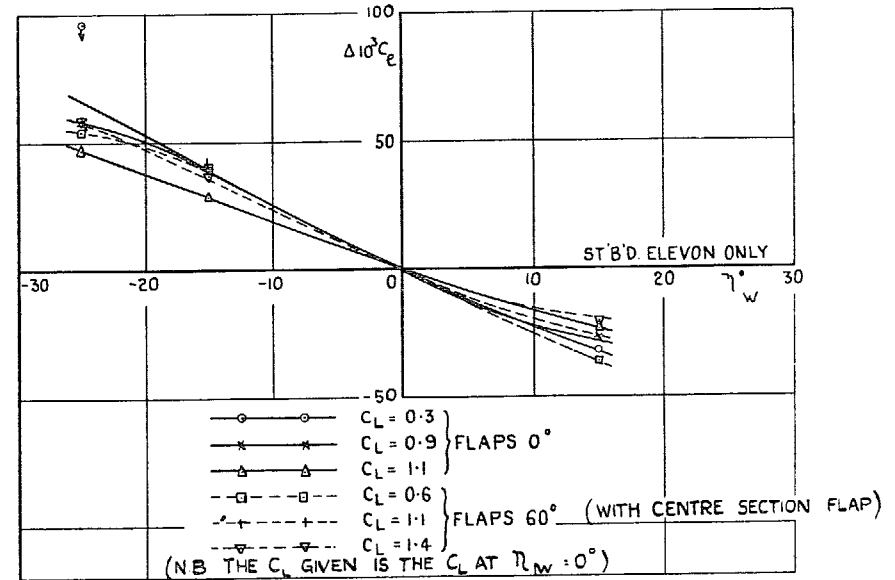

FIG. 23. Rolling moments—Elevons sealed. 28.4 deg. sweepback.

FIGS. 20-23. Elevon power.

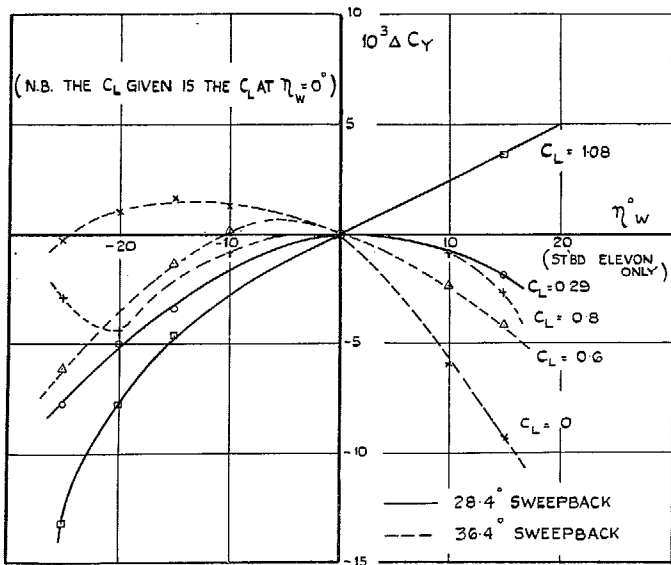

FIG. 24. Sideforce coefficients—Elevons unsealed. Flaps 0 deg.

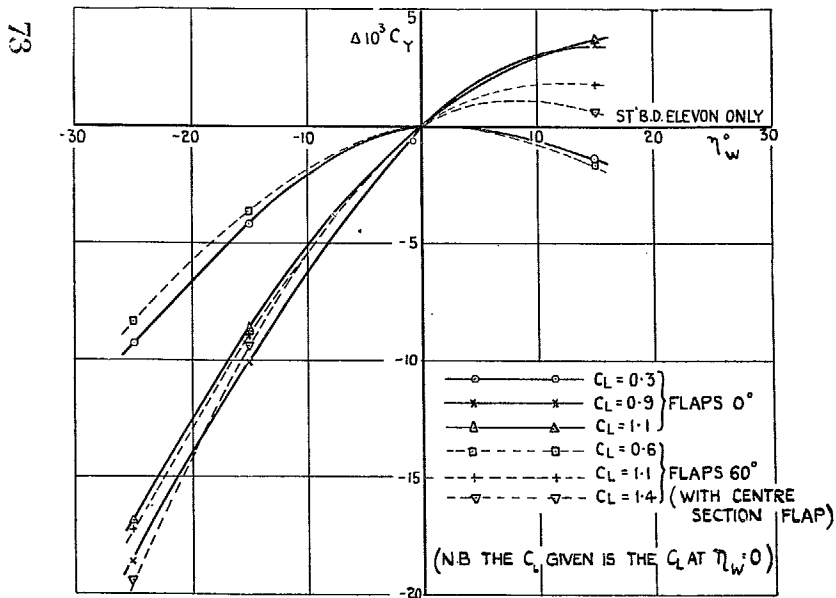

FIG. 25. Sideforce coefficients—Elevons sealed. 28.4 deg. sweepback.

FIGS. 24 and 25. Elevon power.

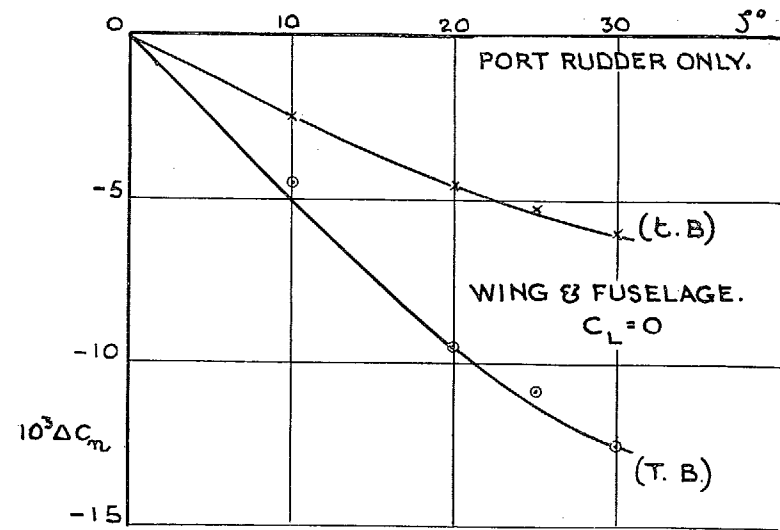

FIG. 26. 28.4 deg. sweepback—Rudder power with conventional rudders.

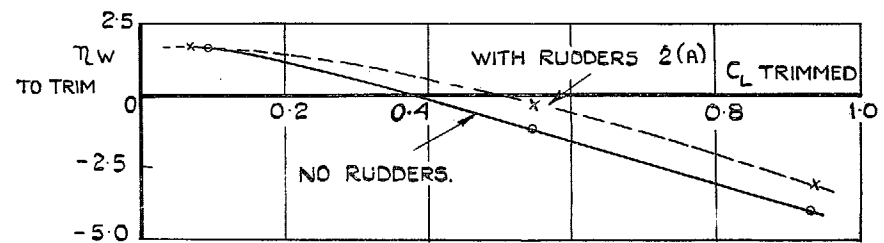

FIG. 27. 28.4 deg. sweepback. Trim curves with drag rudders.

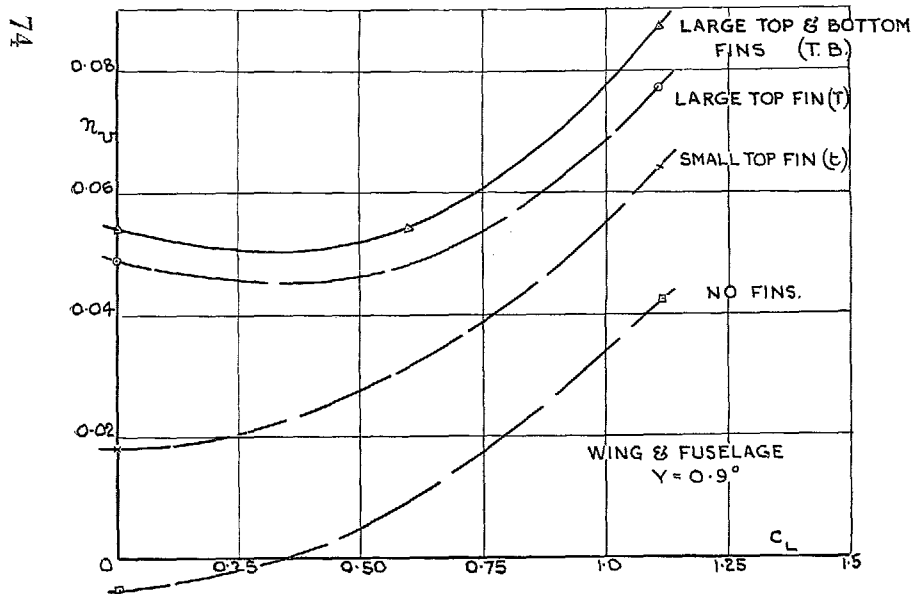
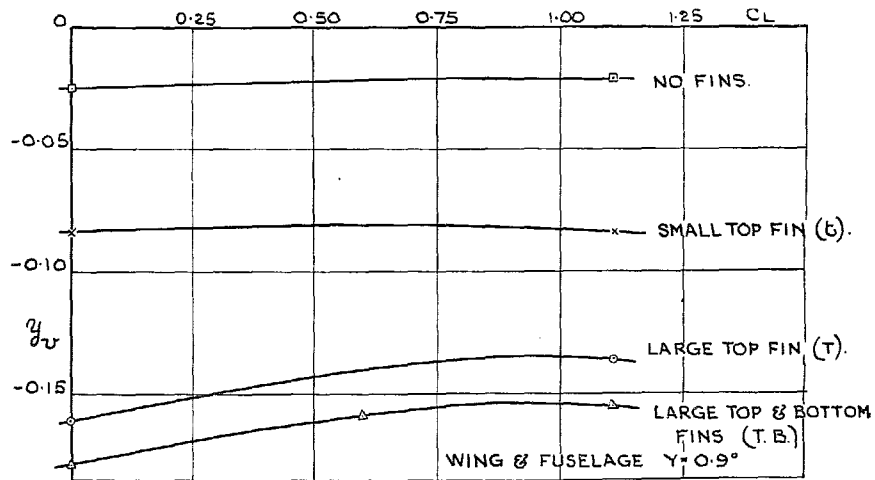

FIG. 28. Effect of fin area on y_v and n_v .
28.4 deg. sweepback. Flaps 0 deg.

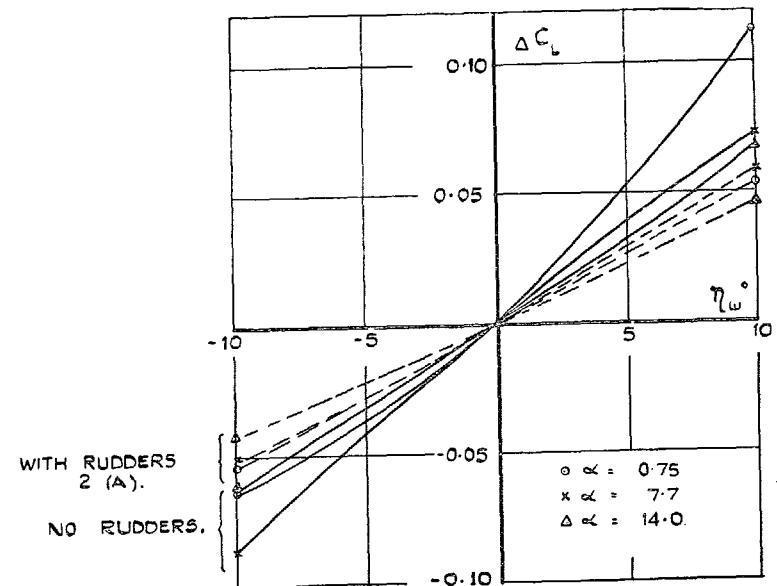

FIG. 29. Lift.

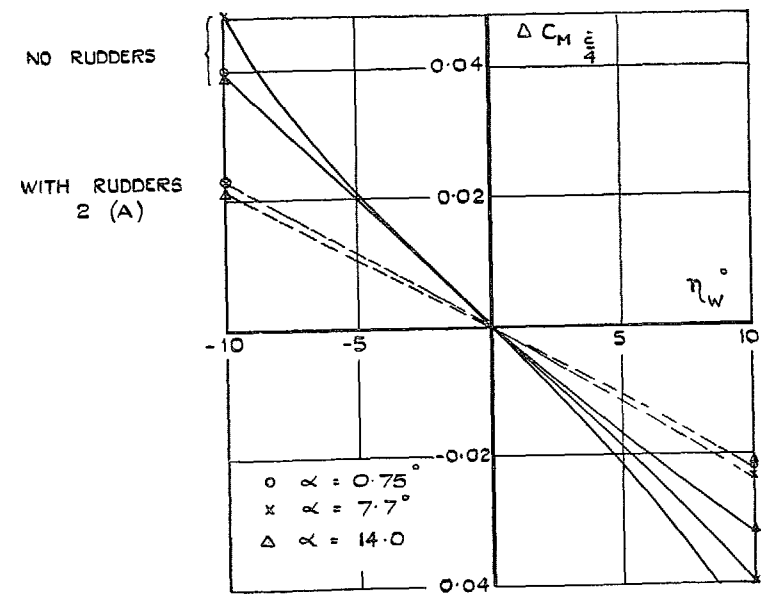

FIG. 30. Pitching moments.

FIGS. 29 and 30. Elevon power with drag rudders
28.4 deg. sweepback. Elevons sealed.

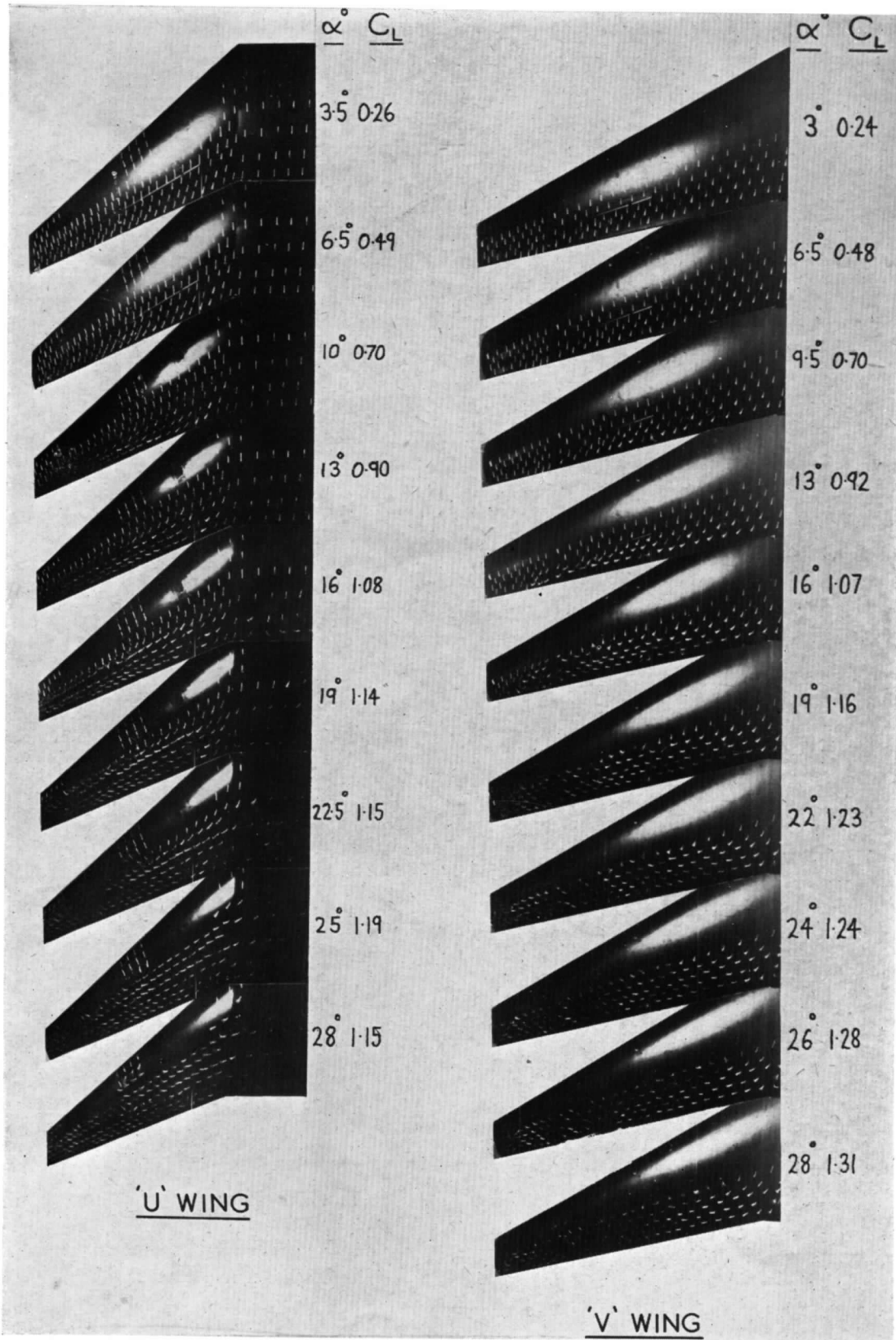

FIG. 31. Flow photographs on "U" and "V" wings. 28.4 deg. sweepback, flaps 0 deg.

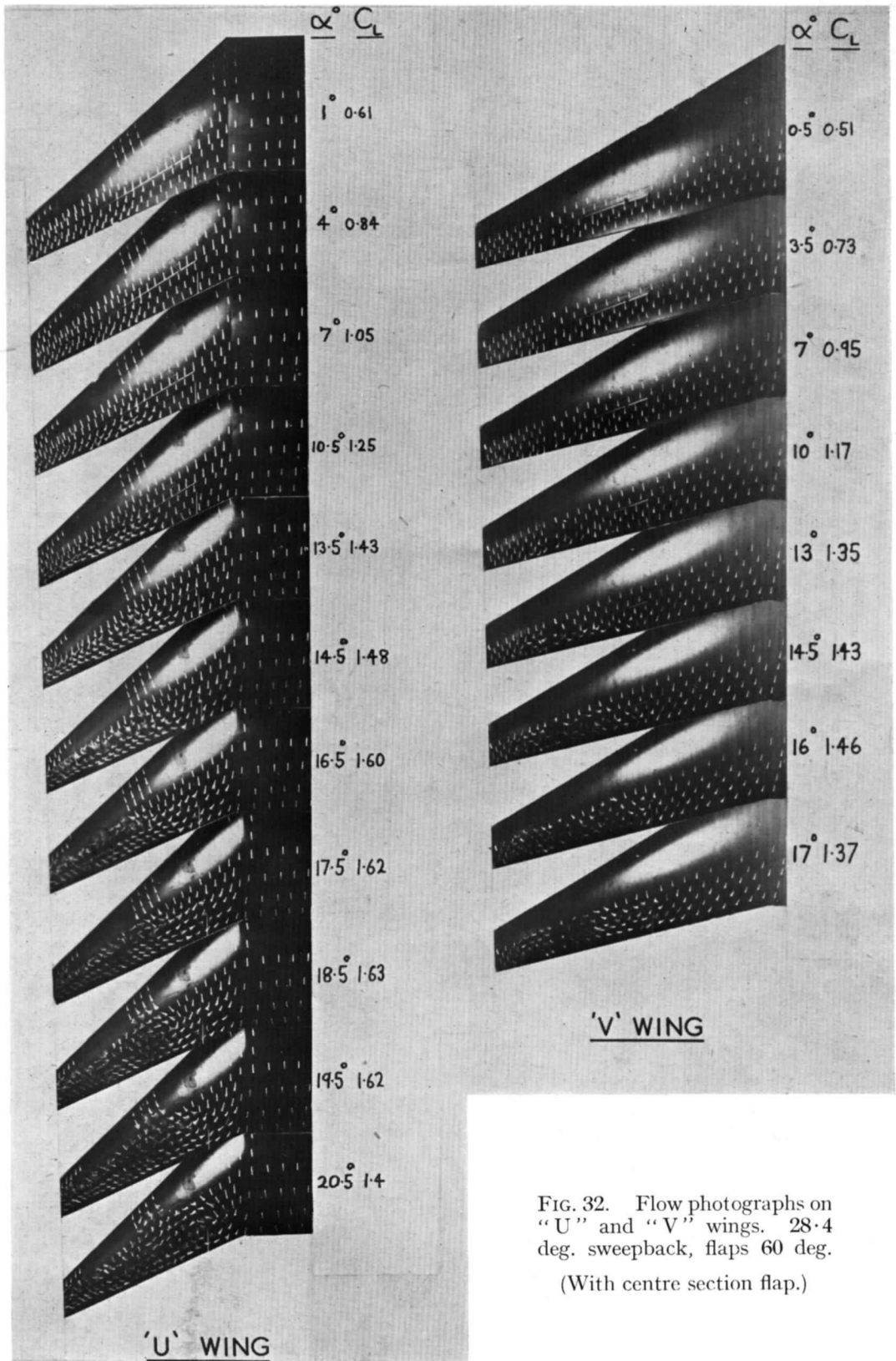
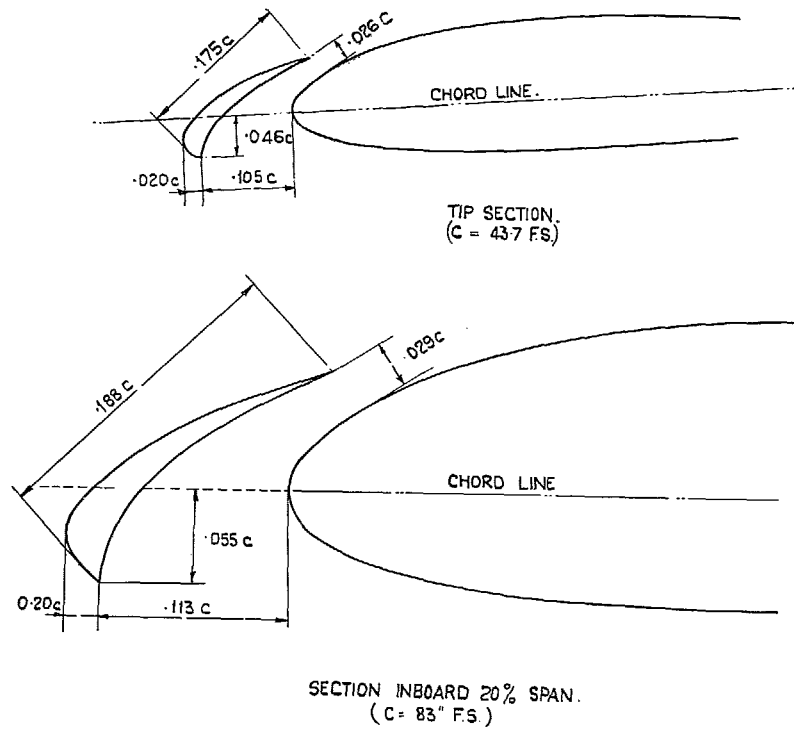

FIG. 32. Flow photographs on "U" and "V" wings. 28.4 deg. sweepback, flaps 60 deg. (With centre section flap.)



MEASUREMENTS ON FIGS ARE GIVEN AS PERCENTAGES OF THE LOCAL CHORD.

INCHES MODEL SCALE.
0 1 2

FIG. 33. "V" wing. 36.4 deg. sweepback—slat sections.
1/5.67 scale model.

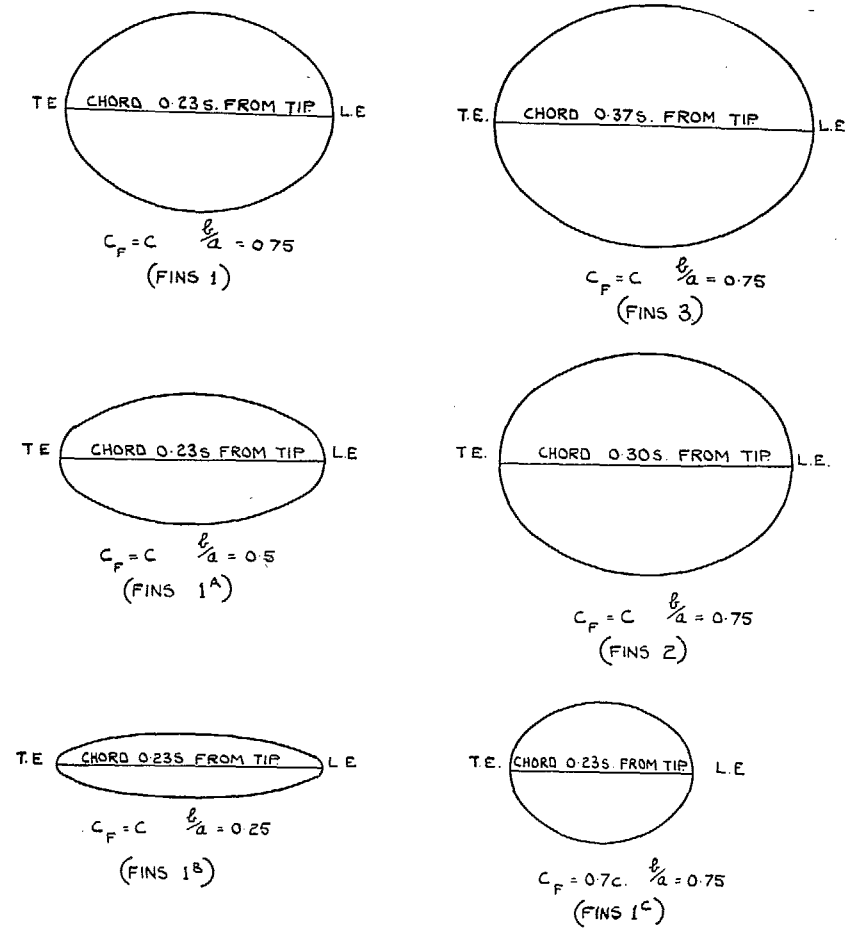

FIG. 34. "V" wing. 28.4 deg. sweepback—inboard fins.
1/5.67 scale model.

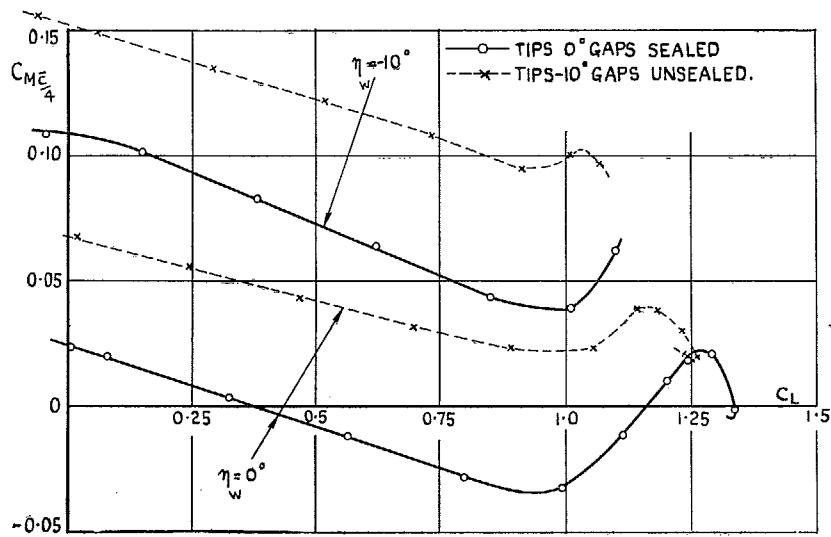

FIG. 38. Wing alone. Flaps 0 deg.
28.4 deg. sweepback.

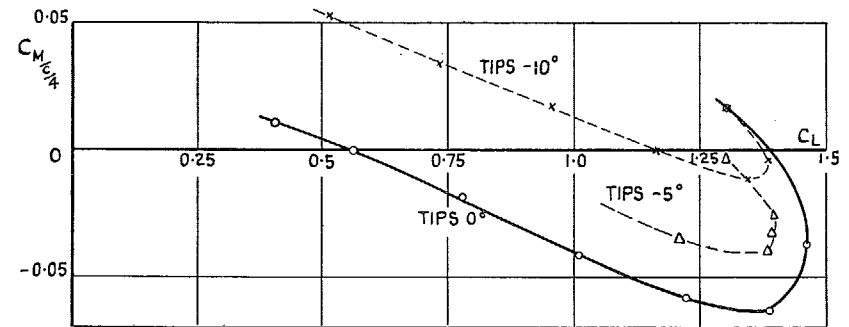

FIG. 40. Wing alone. Flaps 60 deg. Gaps sealed. $\eta_w = 0$ deg.
28.4 deg. sweepback.

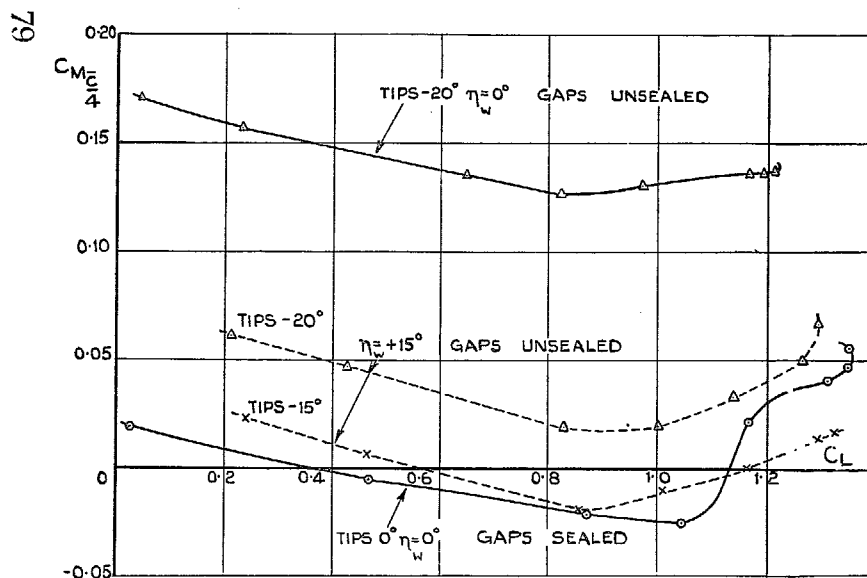

FIG. 39. Wing alone. Flaps 0 deg.
36.4 deg. sweepback.

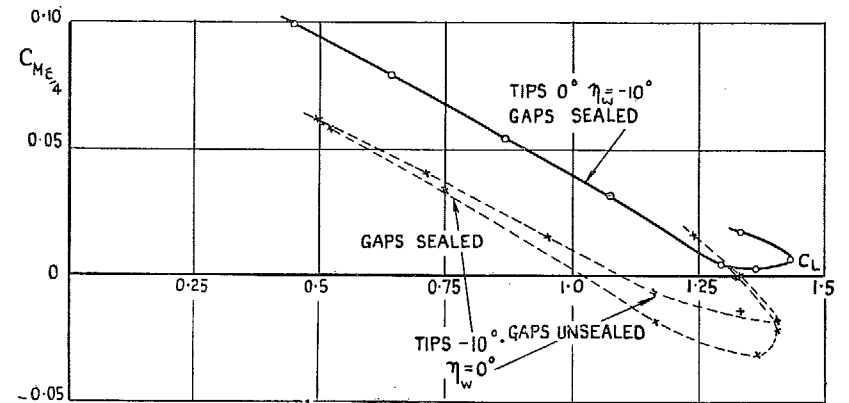

FIG. 41. Wing and fins. Flaps 60 deg.
28.4 deg. sweepback.

FIGS. 38 to 41. Pitching moments. Effect of variable incidence tips.

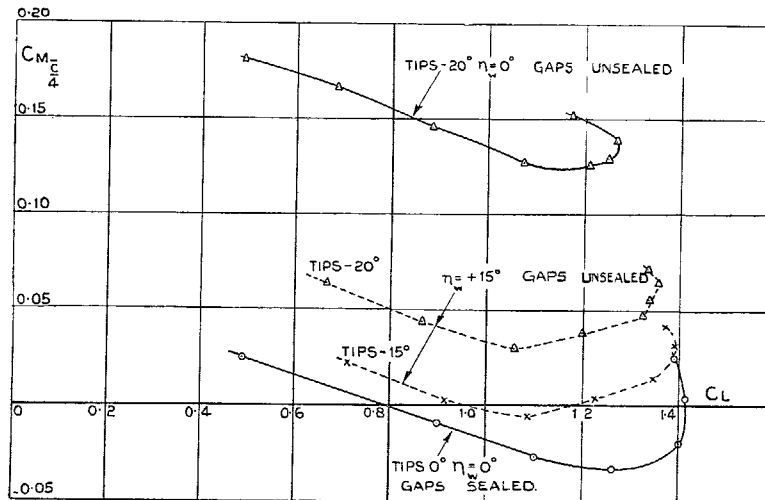

FIG. 42. Pitching moments. Effect of V.I. tips. Wing alone. Flaps 60 deg. (With centre section flap.) 36.4 deg. sweepback.

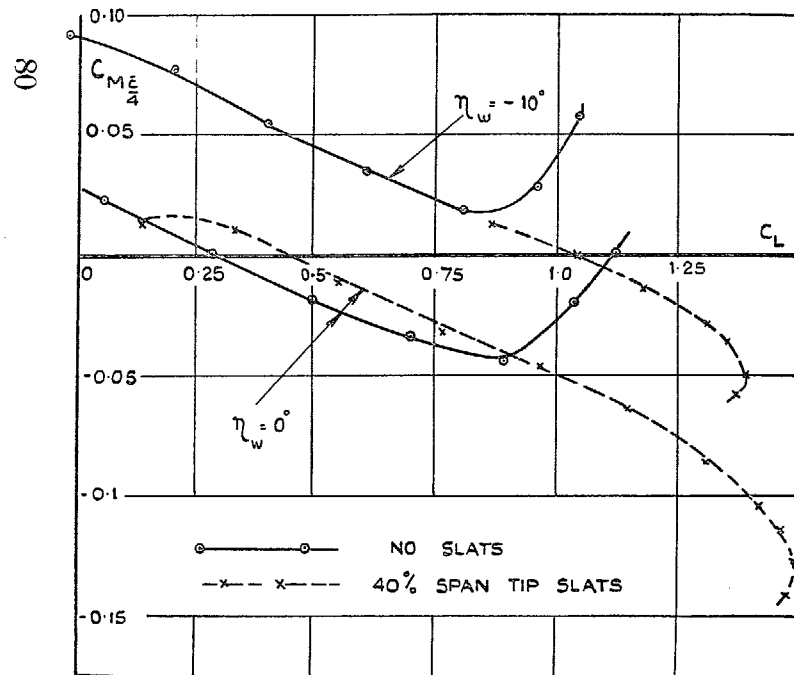

FIG. 43. Complete model. Flaps 0 deg.

FIGS. 43 to 45. Pitching moments. Effect of tip slats. 36.4 deg. sweepback.

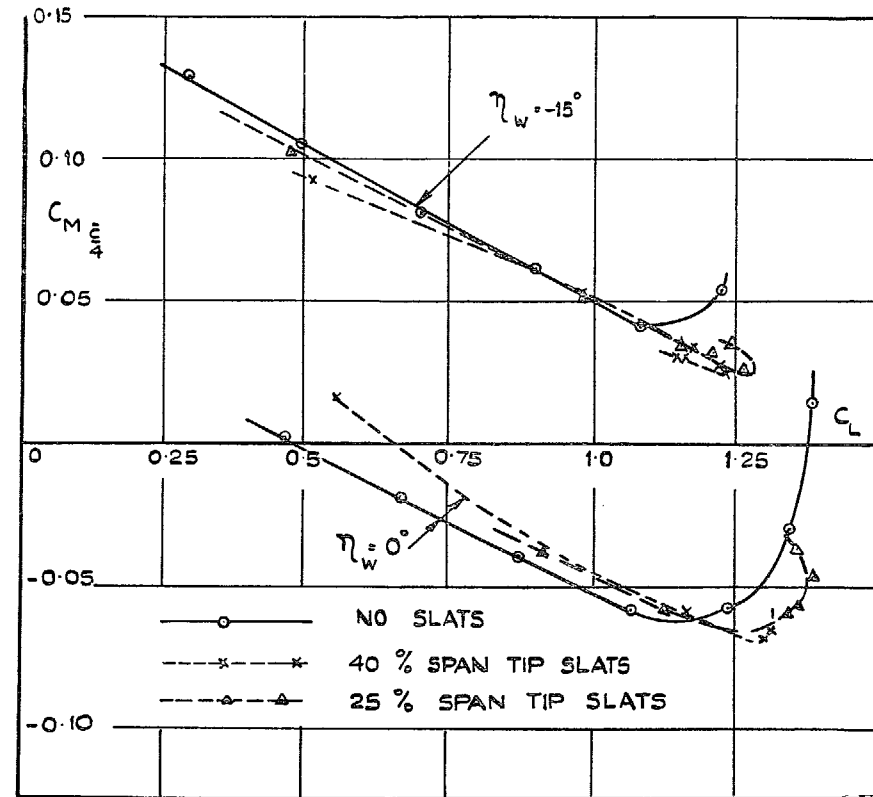

FIG. 44. Complete model. Flaps 60 deg. (No centre section flap.)

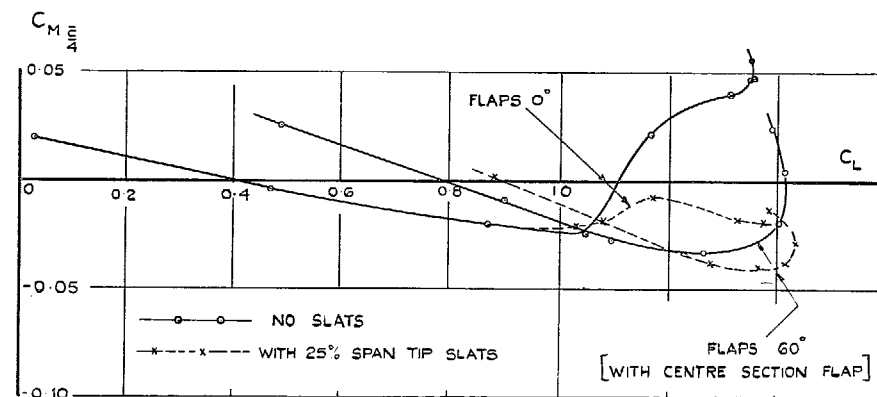

FIG. 45. Wing alone. Flaps 0 deg. and flaps 60 deg.

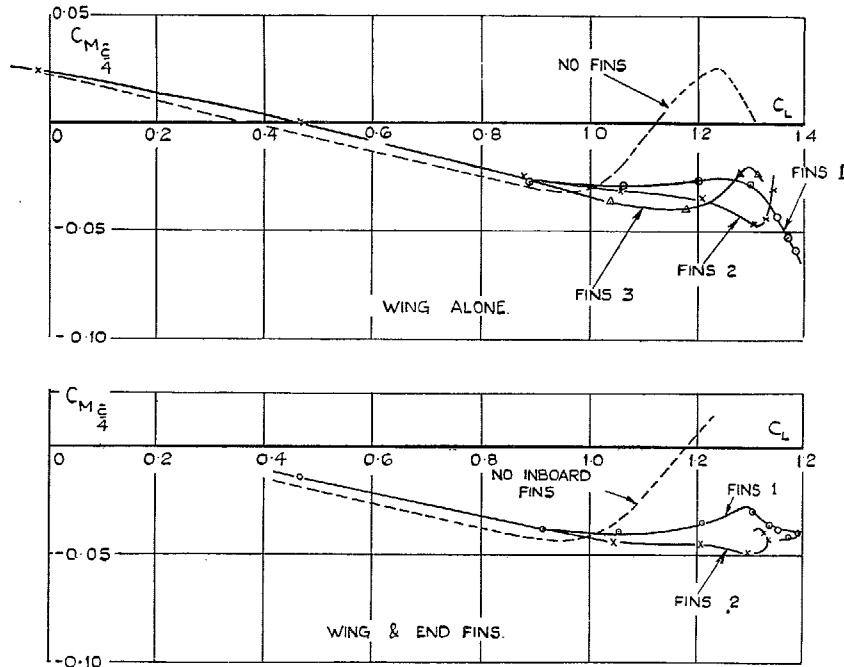

FIG. 46. 28.4 deg. sweepback. Flaps 0 deg.

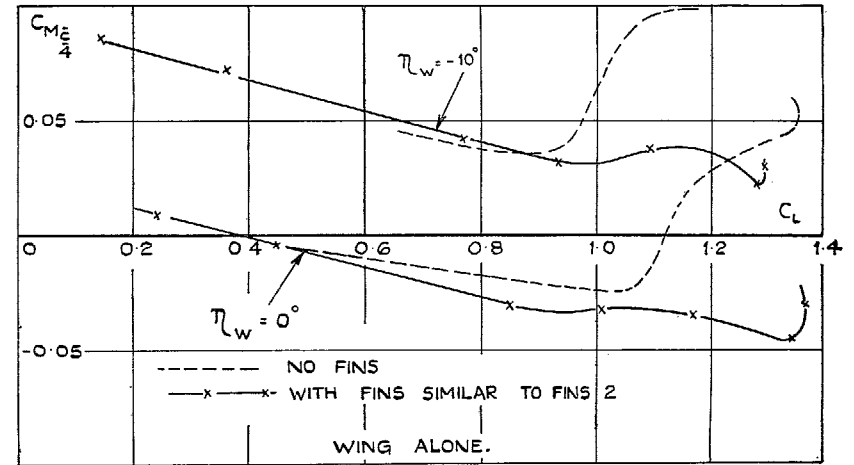
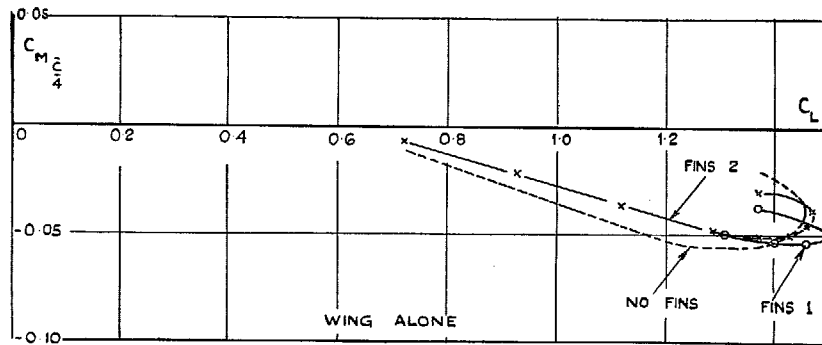

FIG. 48. 36.4 deg. sweepback. Flaps 0 deg.



FINS 1	0.23 S	INBOARD FROM TIP	$C_F = C \frac{b}{a} =$	0.75
FINS 2	0.30 S	"	"	0.75
FINS 3	0.37.5	"	"	0.75

FIG. 47. 28.4 deg. sweepback. Flaps 60 deg. (With centre section flap.)

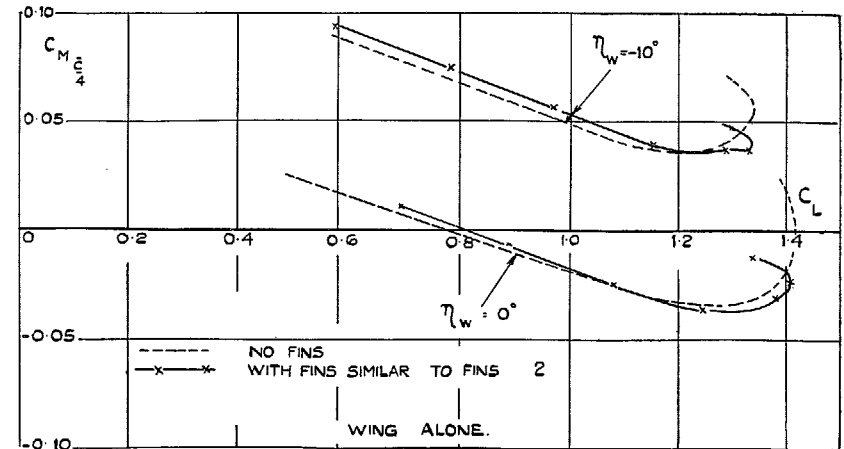

FIG. 49. 36.4 deg. sweepback. Flaps 60 deg. (With centre section flap.)

Figs. 46 to 49. Pitching moments. Effect of inboard fins.

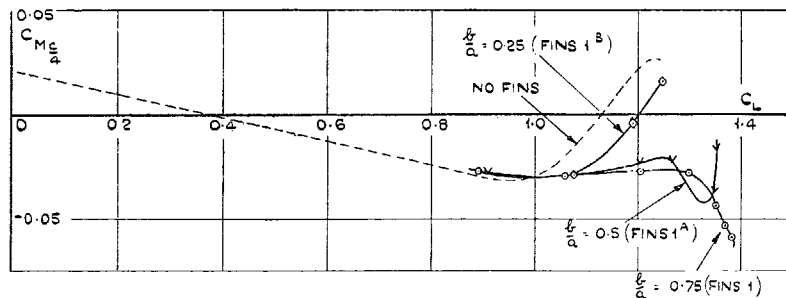

FIG. 50. Effect of fin size.

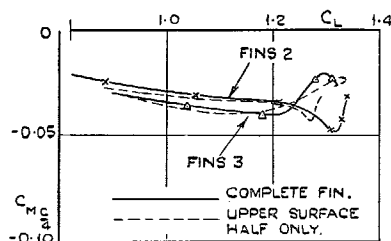

Fig. 51. Effect of half fins.

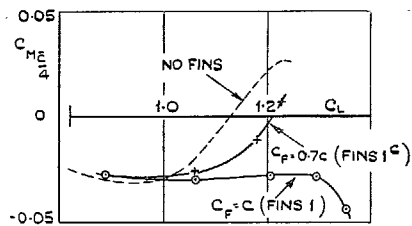

FIG. 52. Effect of C_F/c ratio.

FIGS. 50 to 52. Pitching moments.

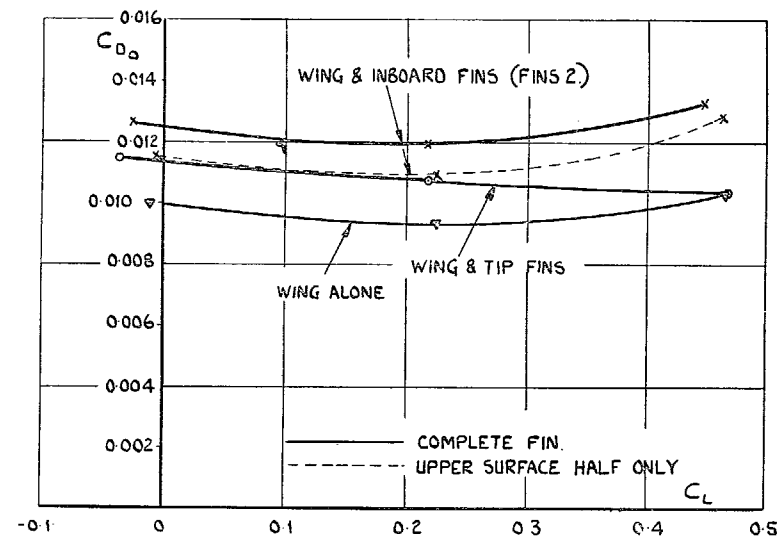

FIG. 54. Profile drag.

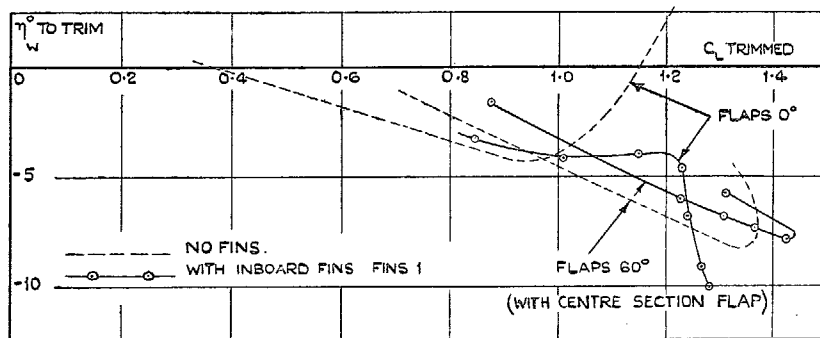

FIG. 53. Trim curves with fins 1.

FINS 1	0.23 s	INBOARD FROM TIPS	} $C_F = C_f \frac{l}{c}$ = 0.75	FINS 1^A	$C_F = C$	$\frac{l}{c} = 0.5$	0.23 s
FINS 2	0.30 s	" " "		FINS 1^B	$C_F = C$	$\frac{l}{c} = 0.25$	INBOARD
FINS 3	0.37 s	" " "		FINS 1^C	$C_F = 0.7c$	$\frac{l}{c} = 0.75$	FROM TIP.

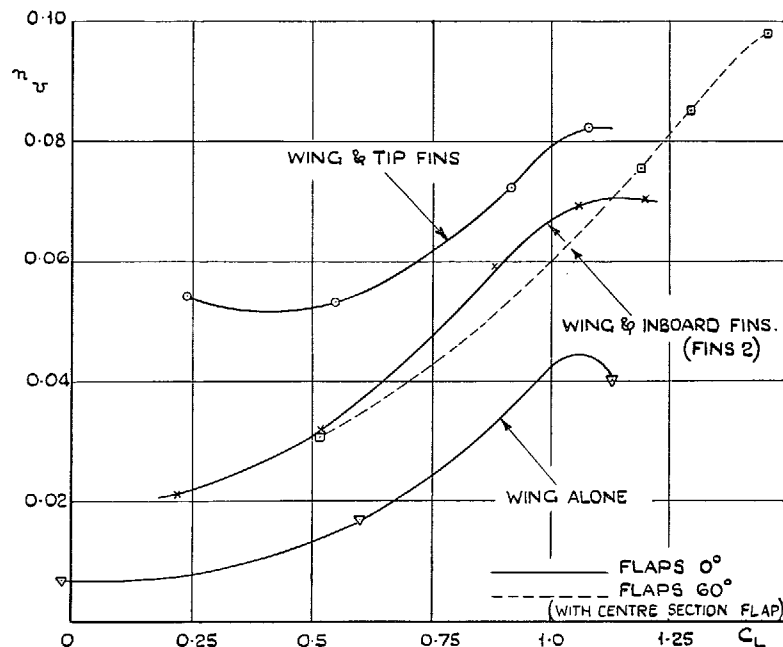

FIG. 55. n_v

FIGS. 50 to 55. Effect of inboard fins. 28.4 deg. sweepback.

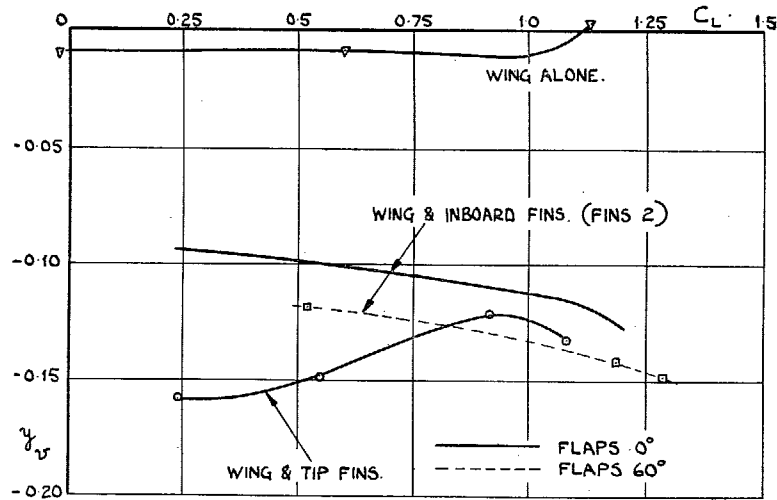

FIG. 56. y_v . Inboard fins 0.30s from tip.
 $c_p = c$; $b/a = 0.75$ (Fins 2).

83

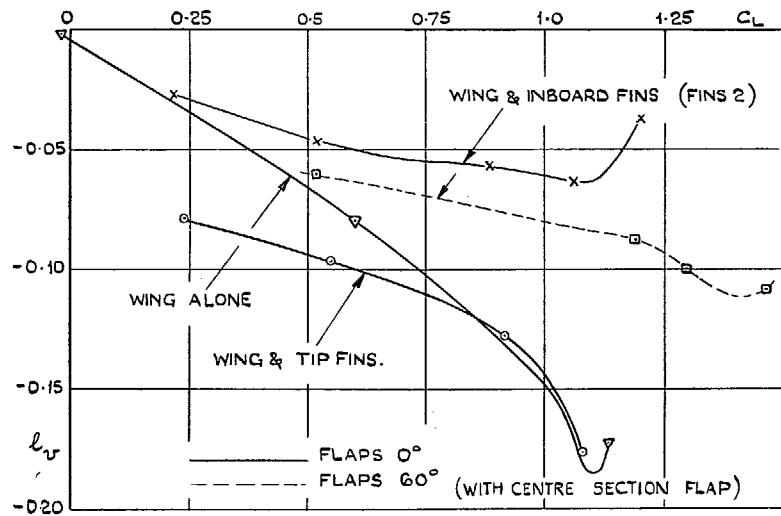

FIG. 57. l_v . Inboard fins 0.30s from tip.
 $c_p = c$; $b/a = 0.75$ (Fins 2).

FIGS. 56 and 57. Effect of inboard fins. 28.4 deg. sweepback.

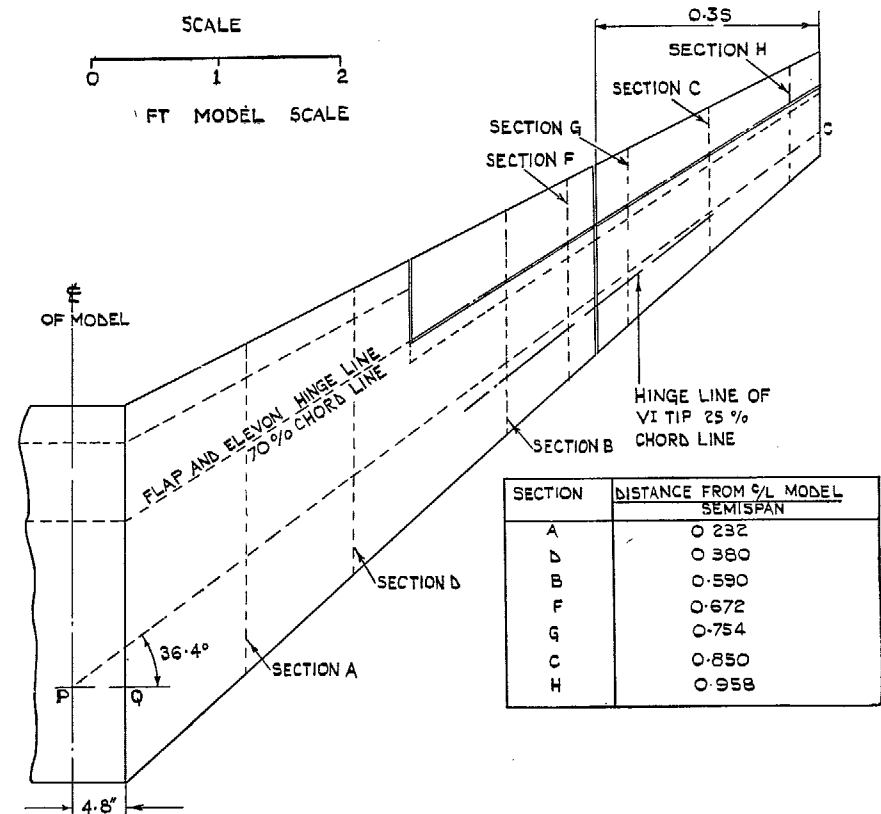
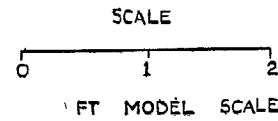
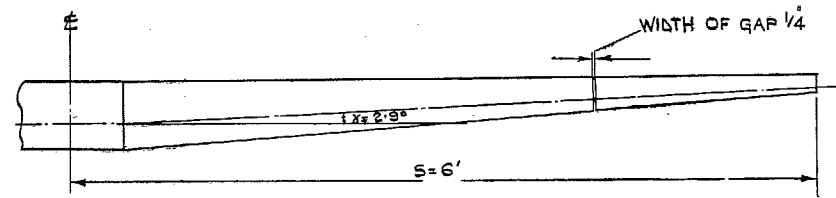

FIG. 58. "V" wing. 36.4 deg. sweepback. 1/3.78 scale model.

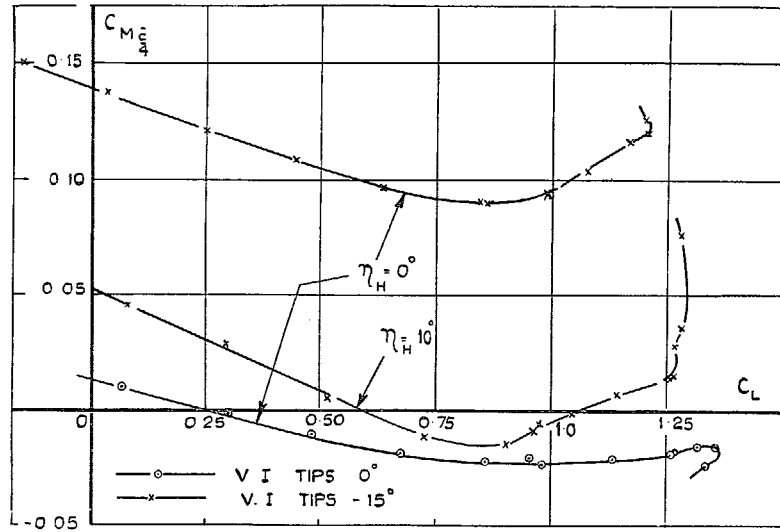

FIG. 59. Flaps 0 deg.

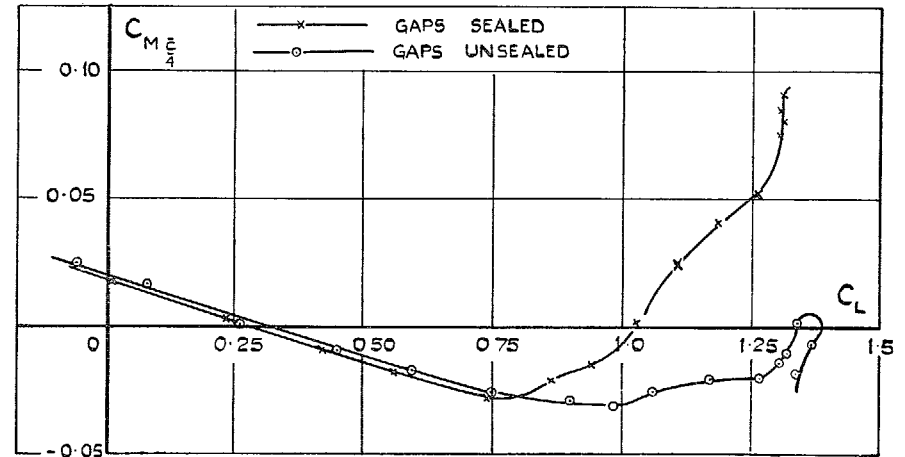

FIG. 61. Flaps 0 deg. Elevons 0 deg. V.I. tips 0 deg.

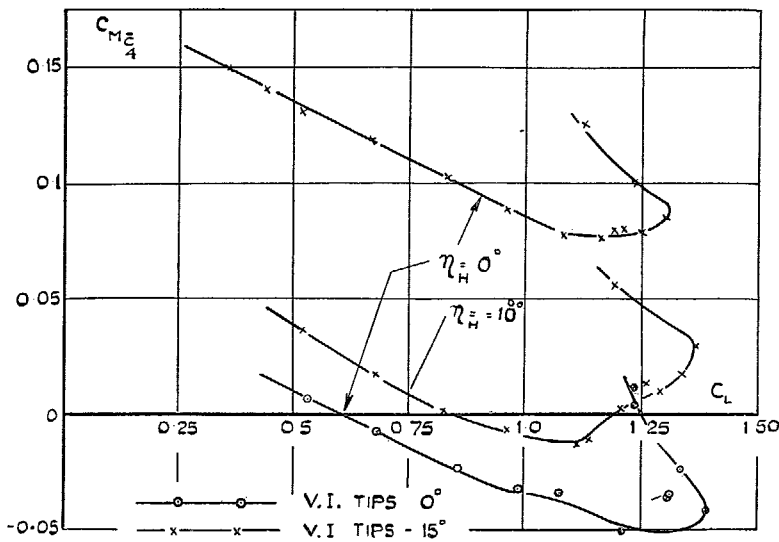

FIG. 60. Flaps 60 deg. (with centre section flap.)

Figs. 59 and 60. Pitching moments. Effect of variable incidence tips. Wing alone. 36.4° sweepback.

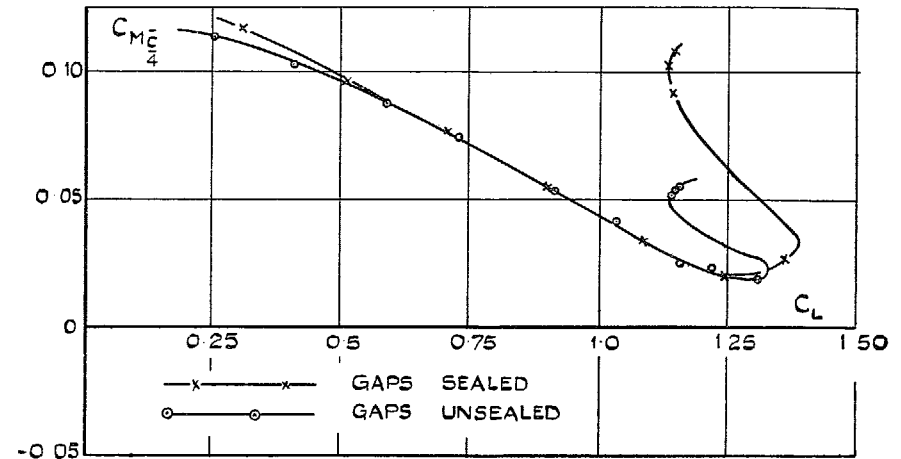

FIG. 62. Flaps 60 deg. (with centre section flap), Elevons -10° , V.I. tips 0 deg.

Figs. 61 and 62. Pitching moments. Effect of sealing gaps. Wing alone. 36.4° sweepback.

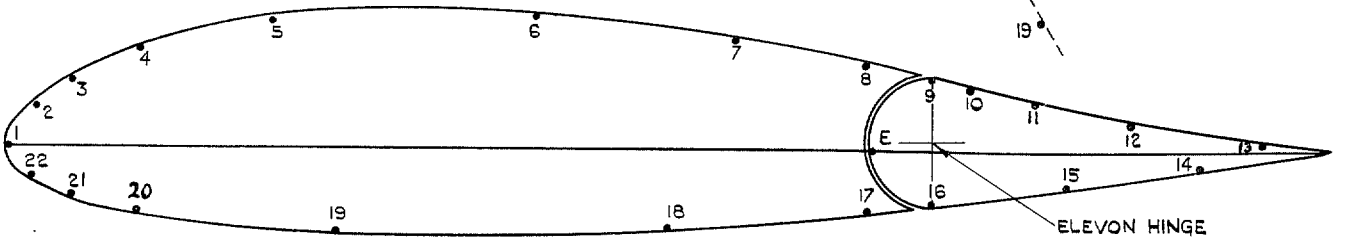
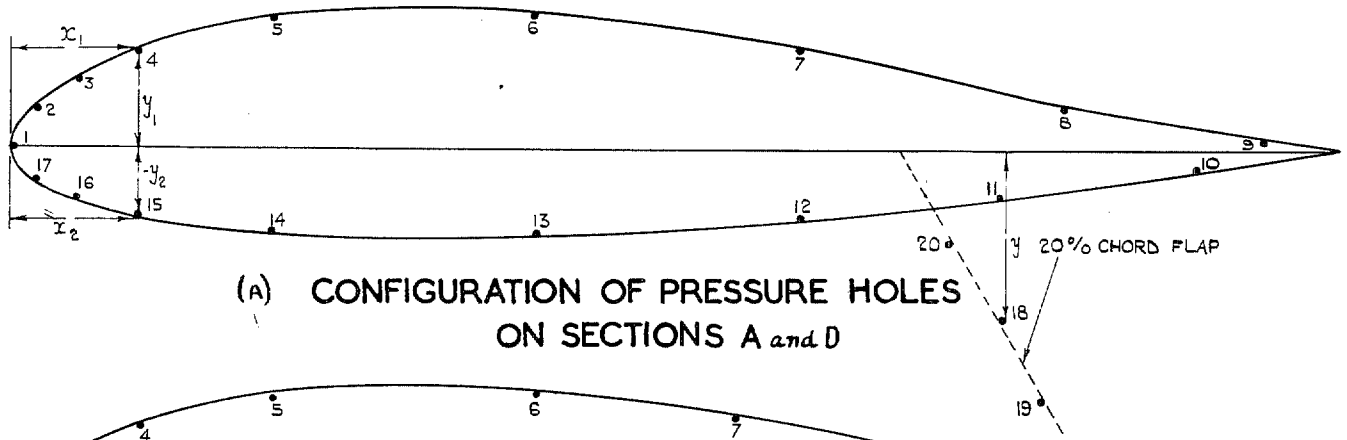

FIG. 63. 36.4 deg. sweepback wing.

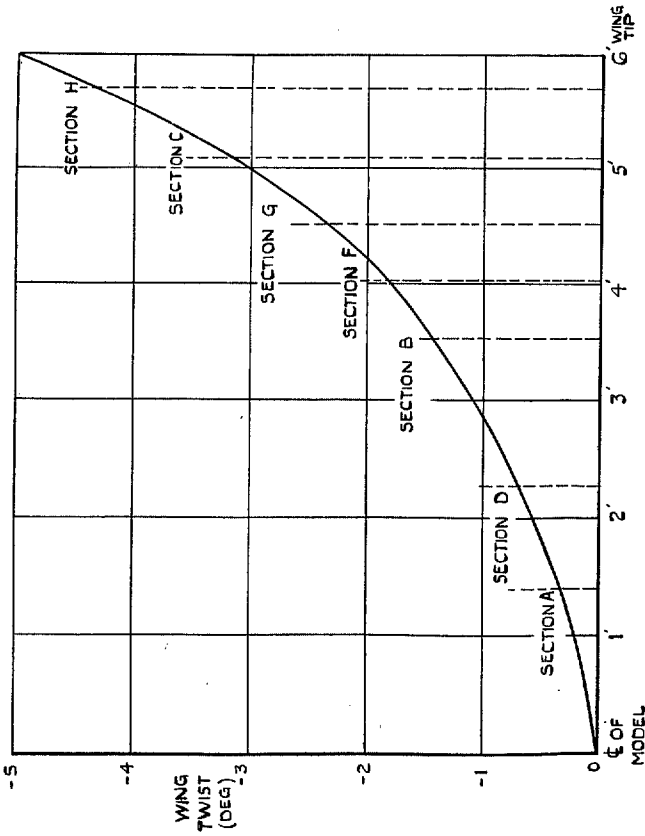

Fig. 64. Spanwise variation of geometric wing twist.

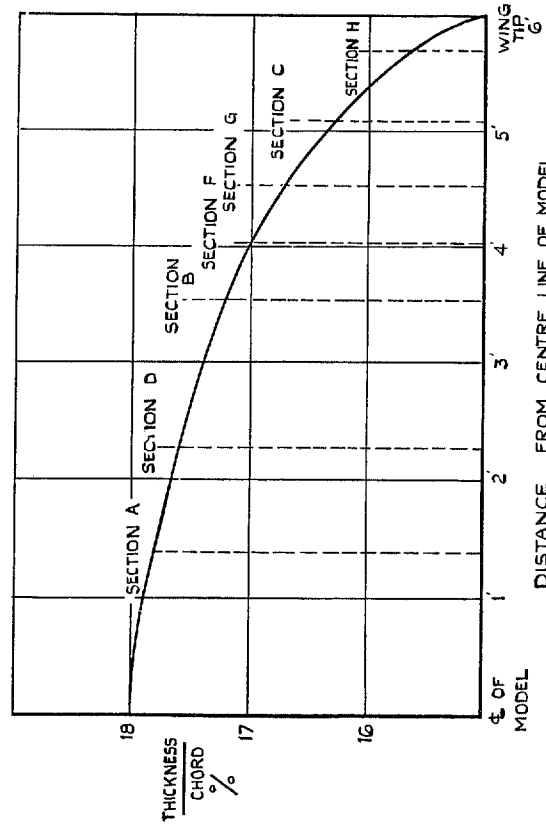

Fig. 65. Spanwise variation of thickness/chord ratio.

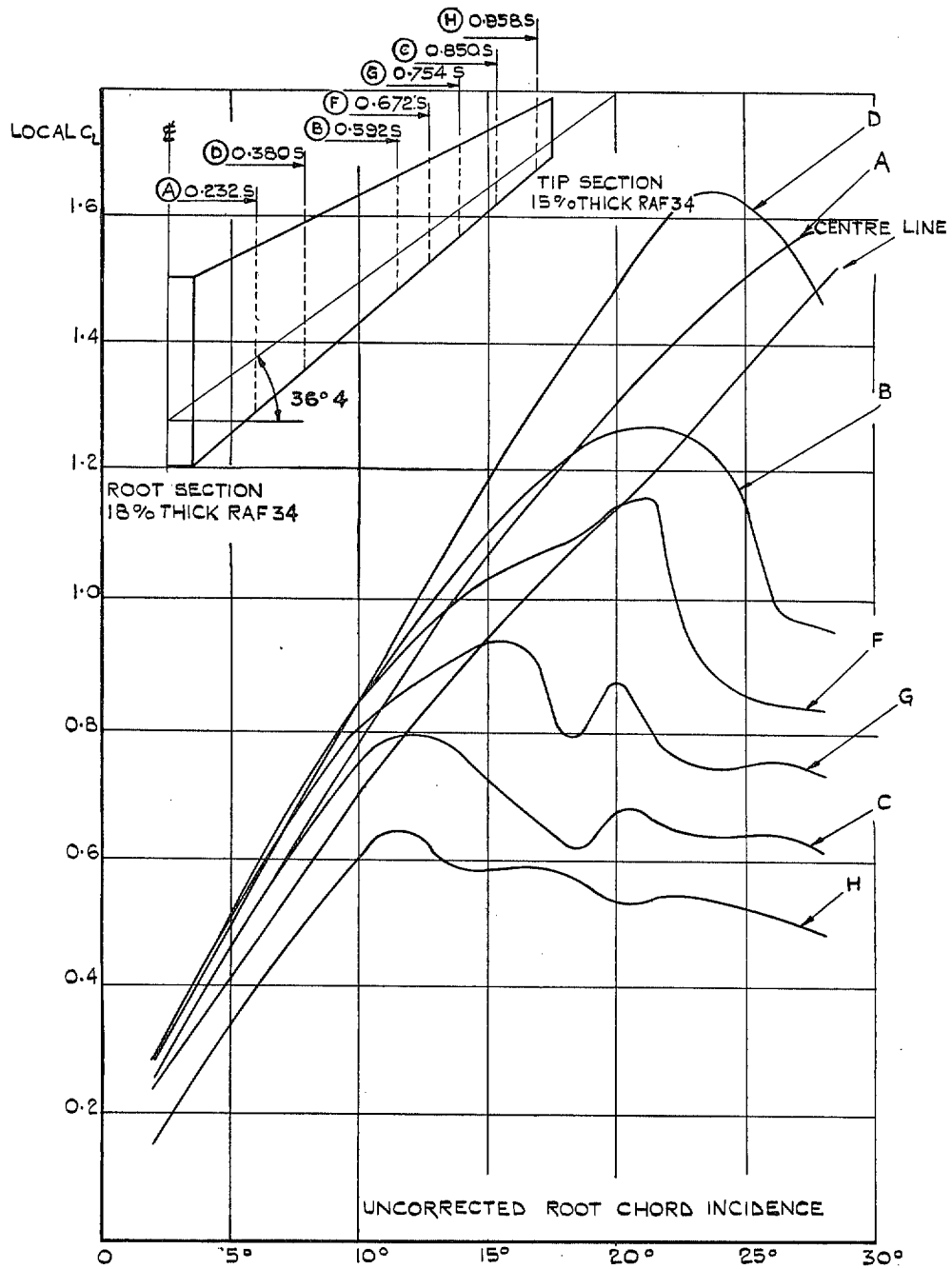

FIG. 66. Spanwise local lift curves on the 36.4 deg. sweepback wing.

Publications of the Aeronautical Research Council

ANNUAL TECHNICAL REPORTS OF THE AERONAUTICAL RESEARCH COUNCIL (BOUND VOLUMES)—

- 1934-35 Vol. I. Aerodynamics. *Out of print.*
Vol. II. Seaplanes, Structures, Engines, Materials, etc. 40s. (40s. 8d.)
- 1935-36 Vol. I. Aerodynamics. 30s. (30s. 7d.)
Vol. II. Structures, Flutter, Engines, Seaplanes, etc. 30s. (30s. 7d.)
- 1936 Vol. I. Aerodynamics General, Performance, Airscrews, Flutter and Spinning.
40s. (40s. 9d.)
Vol. II. Stability and Control, Structures, Seaplanes, Engines, etc. 50s. (50s. 10d.)
- 1937 Vol. I. Aerodynamics General, Performance, Airscrews, Flutter and Spinning.
40s. (40s. 10d.)
Vol. II. Stability and Control, Structures, Seaplanes, Engines, etc. 60s. (61s.)
- 1938 Vol. I. Aerodynamics General, Performance, Airscrews. 50s. (51s.)
Vol. II. Stability and Control, Flutter, Structures, Seaplanes, Wind Tunnels,
Materials. 30s. (30s. 9d.)
- 1939 Vol. I. Aerodynamics General, Performance, Airscrews, Engines. 50s. (50s. 11d.)
Vol. II. Stability and Control, Flutter and Vibration, Instruments, Structures,
Seaplanes, etc. 63s. (64s. 2d.)
- 1940 Aero and Hydrodynamics, Aerofoils, Airscrews, Engines, Flutter, Icing, Stability
and Control, Structures, and a miscellaneous section. 50s. (51s.)

*Certain other reports proper to the 1940 volume will subsequently be
included in a separate volume.*

ANNUAL REPORTS OF THE AERONAUTICAL RESEARCH COUNCIL—

1933-34	1s. 6d. (1s. 8d.)
1934-35	1s. 6d. (1s. 8d.)
April 1, 1935 to December 31, 1936.	4s. (4s. 4d.)
1937	2s. (2s. 2d.)
1938	1s. 6d. (1s. 8d.)
1939-48	3s. (3s. 2d.)

INDEX TO ALL REPORTS AND MEMORANDA PUBLISHED IN THE ANNUAL TECHNICAL REPORTS, AND SEPARATELY—

April, 1950 R. & M. No. 2600. 2s. 6d. (2s. 7½d.)

INDEXES TO THE TECHNICAL REPORTS OF THE AERONAUTICAL RESEARCH COUNCIL—

December 1, 1936 — June 30, 1939.	R. & M. No. 1850. 1s. 3d. (1s. 4½d.)
July 1, 1939 — June 30, 1945.	R. & M. No. 1950. 1s. (1s. 1½d.)
July 1, 1945 — June 30, 1946.	R. & M. No. 2050. 1s. (1s. 1½d.)
July 1, 1946 — December 31, 1946.	R. & M. No. 2150. 1s. 3d. (1s. 4½d.)
January 1, 1947 — June 30, 1947.	R. & M. No. 2250. 1s. 3d. (1s. 4½d.)

Prices in brackets include postage.

Obtainable from

HIS MAJESTY'S STATIONERY OFFICE

York House, Kingsway, LONDON, W.C.2 429 Oxford Street, LONDON, W.1
P.O. Box 569, LONDON, S.E.1
13a Castle Street, EDINBURGH, 2 1 St. Andrew's Crescent, CARDIFF
39 King Street, MANCHESTER, 2 Tower Lane, BRISTOL, 1
2 Edmund Street, BIRMINGHAM, 3 80 Chichester Street, BELFAST

or through any bookseller.