



MINISTRY OF SUPPLY  
AERONAUTICAL RESEARCH COUNCIL  
REPORTS AND MEMORANDA

# Improvements in the Fatigue Strength of Joints by the Use of Interference Fits

*By*

W. A. P. FISHER, B.A., A.M.I.Mech.E.  
and  
W. J. WINKWORTH, A.M.I.Mech.E.

*Crown Copyright Reserved*

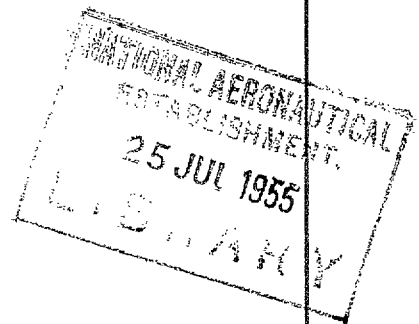

LONDON: HER MAJESTY'S STATIONERY OFFICE

1955

FIVE SHILLINGS NET

# Improvements in the Fatigue Strength of Joints by the Use of Interference Fits

By

W. A. P. FISHER, B.A., A.M.I.Mech.E.

and

W. J. WINKWORTH, A.M.I.Mech.E.

COMMUNICATED BY THE PRINCIPAL DIRECTOR OF SCIENTIFIC RESEARCH (AIR),  
MINISTRY OF SUPPLY

---

*Reports and Memoranda No. 2874\**

*May, 1952*

---

*Summary.*—A study is made of the effect of interference fit in loaded holes on the fatigue strength of the associated part.

Fatigue-test results are given for aluminium alloy flat bars with a single hole loaded by a pin in double shear. Two series of tests were made. In one series the pin was fitted directly in the hole with various degrees of interference fit up to 0.003 in. excess diameter. The other series had a mild steel bush interposed with similar degrees of interference in the bar, but with a push fit between pin and bush. Both sets showed a great increase in fatigue strength for interference fits above a critical value.

The application of these results for raising the fatigue strength of aircraft structural joints is considered.

---

1. *Introduction.*—Bolted connections, in which the load is transmitted by shear in the shank of the bolt, are extensively used in aircraft structural joints. The fatigue strength of such a joint is determined by the conditions at the loaded holes in the joint members, which normally consist of light alloy bars with flat ends. When the joint is tested under fluctuating tension, fatigue cracks, originating from the boundary of a hole, increase in size and finally result in complete rupture of the bar. The origin of the crack coincides with the position of highest stress concentration. The simplest case is that of a lug, symmetrically loaded in tension by a bolt passing through a hole drilled on the axis of the lug. Frocht and Hill<sup>1</sup> (1948) have investigated this case photo-elastically, and have given curves for the variation of the elastic stress concentration factor with the dimensions of the bar in relation to the size of hole. They have also shown that the elastic stress concentration factor is reduced by changing from a clearance fit to a tight fit. The fatigue strength of loaded-hole specimens, however, is found to be much less than expected from photo-elastic data. With loaded holes (in contrast to open holes) fatigue resistance can be reduced by fretting at the boundary of the hole and, in some cases, by flexure of the pin. Both these effects are less likely to occur with a tight-fitting bolt. In addition, the interference fit tends to reduce the stress concentration in relation to alternating stress at the expense of the less serious steady stress associated with pre-loading. Thus there are reasonable grounds for expecting an increase in fatigue strength from interference fits.

---

\* R.A.E. Report Structures 127, received 27th June, 1952.

A series of tests was therefore made under fixed loading conditions on simple lug specimens with a single bolt in double shear, with various degrees of interference fit extending to a hard drive fit. A further series of tests was made with simple lug specimens in which the holes had been fitted with mild steel bushes having various degrees of interference, the bolts being an easy fit in the bushes. The second method was investigated because in practice it is much easier to follow than the first.

2. *Tests on Loaded Bushed Holes with Different Degrees of Interference Fit.*—A series of twelve tests was made in order to investigate the effect of fit of a mild steel bush on the fatigue strength of the aluminium alloy bar in which the bush is fitted.

2.1. *Test Specimens.*—As indicated on Fig. 1, the test specimens were simple links made from aluminium alloy extruded bar (D.T.D.364) of 2-in.  $\times$   $\frac{3}{8}$ -in. cross-section, the original surface having been removed by grinding. The  $\frac{3}{4}$ -in. holes in the bars were reamed and burrs removed. Prior to assembly, the holes and the ground-finish mild steel bushes were accurately measured and subsequently matched to give a series of specimens with a variety of interference fits ranging from 0.0009 in. to 0.0028 in. in diameter. The loads required to insert the bushes, which were lightly greased prior to assembly, are given in Table 1 and Fig. 3. The measurements across two diameters of each bush and hole are given in Table. 1.

As the bushes were  $\frac{3}{4}$ -in. outside diameter and  $\frac{5}{8}$ -in. inside diameter, the bushed specimens (Nos. 1 to 9) were tested with  $\frac{5}{8}$ -in. diameter ground-finish pins. Specimens Nos. 10 to 12, representing the limiting case of no interference, were tested as plain loaded holes with  $\frac{3}{4}$ -in. diameter pins.

All pins were assembled by hand, the fit varying between an easy push fit and a sliding fit.

2.2. *Method of Testing.*—Steel adaptor fittings, as shown in Fig. 2, were used for mounting the specimens in the 20-ton Avery Schenck Fatigue-Testing Machine.

2.3. *Test Loading.*—Loads were applied to all the specimens to produce tensile stresses at the section through the hole of  $6 \text{ ton/in.}^2 \pm 1.8 \text{ ton/in.}^2$  ( $13,440 \text{ lb/in.}^2 \pm 4,030 \text{ lb/in.}^2$ ). These stresses are comparable with those arising at critical sections in aircraft joints when tested at the Royal Aircraft Establishment standard loading, namely '  $1g \pm 7.5$  per cent ultimate design load.'

2.4. *Test Results.*—The test results are shown on Table 2 and Fig. 4. It will be seen that lugs with bushed holes with interference fits of up to 0.002 in. give endurance values neither appreciably better nor worse than those of the similar plain-hole specimens Nos. 10 to 12, whereas interference fits of more than approximately 0.0025 in. produce a great increase in endurance. In Fig. 5 the results are plotted as stress against endurance. The endurance curve shown for comparison is representative of some of the best aircraft structural joints tested to date. Photographs of typical specimen failures are shown on Fig. 6. Photographs of the fractured surfaces are shown on Fig. 7.

It may be observed that the bushed specimens tended to fracture in fatigue on only one side of the hole, the other side failing statically; plain-hole specimens, on the other hand, consistently produced areas of fatigue on both sides of the hole as shown in Fig. 12.

2.4.1. *Condition of bushes after fracture.*—The inside of all the bushes showed evidence of fretting between pin and bush. This internal fretting, however, is unimportant.

On the other hand, fretting between the bush and the light alloy bar occurs normally at the flanks, where the peak tensile stress in the bar is to be found. Fretting marks at the side of a bush which had low interference (approximately 0.001 in.) are shown in Fig. 8a. After only 310,000 cycles the flanks of the bush show strong fretting marks.

Fig. 8b shows front and side views of a bush with high interference fit after more than 12 million cycles. Severe fretting is shown on the rear face. At the side, the fretting is no worse than in Fig. 8a, and the front is completely free from fretting.

3. *Tests on Loaded Plain-Hole Specimens with Different Degrees of Interference Fit.*—3.1. *Test Specimens.*—The material for these specimens was aluminum alloy extruded bar to Specification D.T.D.364B. The flat surfaces were ground free from scratches and tool marks; the holes were reamed to size and burrs removed. Geometric details are given on Fig. 9. The  $\frac{3}{4}$ -in. diameter holes were accurately measured, and fine ground mild steel pins were selected to obtain fits varying between 0.0008 in. clearance to 0.0034 in. interference. The pins were greased on assembly and were inserted with a hammer.

3.2. *Method of Testing.*—The tests were carried out in the 20-ton Avery Schenck Fatigue-Testing machine. Fig. 10 shows a fractured specimen in the machine.

3.3. *Test Loading.*—Tensile stresses at the bolt hole were again  $6 \text{ ton/in.}^2 \pm 1.8 \text{ ton/in.}^2$ , for all specimens, as in the loaded bushed hole tests.

3.4. *Test Results.*—The test results are given on Table 3 and on Fig. 11.

It will be noted that in these tests the large increase in endurance occurs at fits of 0.003 in. interference, compared with 0.0025 in. interference in the bushed hole tests.

All specimens had relatively large fatigue fracture areas on both sizes of the hole. Typical fractures are illustrated on Fig. 12.

4. *Discussion of Results.*—4.1. *Comparison Between the Two Sets of Results.*—With small or moderate interference fit the precise amount of the interference does not appear to affect the endurance at the particular loading condition used in the tests. The scatter is small, and both sets of tests are in good agreement. It cannot be said, however, that the bushes reproduced precisely the same conditions in the light alloy bar as the oversize bolts; for, with the bushed specimens, fatigue failure was confined to one side of the hole only, whereas in the other specimens cracks were propagated on both sides.

Both sets of tests agree closely as regards the degree of interference fit (0.0025 in. to 0.0030 in.) necessary to produce the large increase in endurance. In both instances, the endurance was raised from about 400,000 cycles to beyond 13,000,000 cycles (unbroken).

4.2. *Comparison with Other Test Data.*—Fatigue tests on bolted joints with fits varying from 0.0025 in. clearance to 0.001 in. interference reported in N.A.C.A. Tech. Note 1030<sup>2</sup> (1950) showed no appreciable effect on fatigue strength due to changing the fit of the bolt. The present results agree with the N.A.C.A. tests within the above range of interference, but at higher interferences, not covered by those tests, a critical value of interference is found beyond which the fatigue strength is vastly improved.

4.3. *Reasons for Improved Fatigue Strength.*—It is not difficult to suggest reasons for the great improvement in fatigue strength found for joints with high interference fits; but it is hard to discriminate between the influence of entirely different effects, each of which might produce that result. One possible explanation is that fretting between the pin and the hole is prevented when the pin is sufficiently tight. Another possible explanation is that of elastic relief due to pre-stressing, corresponding with that obtainable by the pre-tensioning of bolts<sup>3</sup>.

The information given by the present limited series of tests is of no value in deciding which of the two explanations given above is the more important. Probably the two effects are concurrent.

4.4. *Practical Application.*—From the practical viewpoint it suffices that the fatigue strength of this elementary form of joint can be made much better than that of the best typical aircraft wing joints. Moreover, in joints employing only one or two bolts in double shear, the improvement may be obtained with very little increase in weight or production cost. In single-bolt joints the holes are usually bushed in order to prevent damage on assembly, and the changes required for obtaining a high interference fit would be very small.

For ease of assembly, the bushing procedure is to be preferred, as it is much easier to fit a tight bush before final assembly than a tight bolt on assembly.

As a method for obtaining greater fatigue strength in aircraft structural joints, the use of high interference fits has practical limitations. The difficulty of inserting a tight bush without damaging the aluminium alloy parts increases with the diameter of the bush and the thickness of the part.

Also, the practicability of bushing holes, and ensuring at the same time an exact fit, decreases rapidly with the number of bolts employed. When the number is large, an alternative method available is the tight clamping of joints described in a previous report<sup>4</sup>.

4.5. *Possible Objections to Use of High Interference Fit.*—4.5.1. *Built-in stress.*—An objection which may be raised is the possibility of splitting the end of the bar in a longitudinal direction owing to the bursting pressure of the bush. This possibility need only be considered where the cross-grain tensile strength of the material is low.

A simple calculation shows that, neglecting any compression in the bush, an interference fit of 0.003 in. in a diameter of 0.75 in. produces a circumferential strain of 0.004, which is about  $\frac{2}{3}$  the strain at the 0.1 per cent proof stress in pure tension for typical aluminium alloys. But part of this strain is due to the radial compressive stress, and there must also be some radial compression of the bush tending to reduce the above figure. Thus, the material does not reach its 0.1 per cent proof stress as a result of the critical interference fit of 0.003 in. In production, even with fine tolerances, uniformity of fit could not be ensured to closer than 0.001 in. Hence, to ensure that in all cases the interference fit exceeds the critical value, it would be necessary to allow for maximum interferences exceeding that value by (say) 0.001 in. Even then, the circumferential stress would not appear to be dangerous but there is need for fine limits on diameters.

The effect of a tight bush or pin on the static strength of a lug in materials with pronounced longitudinal grain (as produced in the extrusion process), should be investigated experimentally.

4.5.2. *Effect of low temperature.*—In high-altitude flying, temperatures of  $-60$  deg C may be reached. The greater coefficient of linear expansion of the light alloy compared with steel will cause additional tightness due to shrinking. The effect is small, however, since on the assumption of a relative expansion coefficient of 0.00001 per deg C and a temperature drop of 80 deg C, the increase in interference is only 0.0006 in. for a  $\frac{3}{4}$ -in. diameter hole. This increase, of course, is an additional safeguard against fatigue at low temperatures.

5. *Further Investigations.*—In view of the basic importance of the loaded hole as a structural feature susceptible to fatigue, the great improvement in fatigue strength shown in these tests merits further investigation. The directions in which the practical testing work should be extended are considered in subsequent sections.

5.1. *Extension of Tests to Various Load Levels.*—As a next step, the alternating load should be varied, keeping the mean load and the interference fit constant, so as to obtain endurance curves for specimens having loaded holes with high interference fit to compare with typical curves for push-fit specimens.

A more comprehensive investigation involving the determination of similar curves for various mean loads, is contemplated.

5.2. *Degree of Interference Necessary for Various Hole Diameters.*—The present tests are limited to one size of hole, *i.e.*, 0.75-in. diameter. For other sizes of hole, the critical interference would probably vary in proportion to the diameter, but tests at different hole diameters are required to confirm this supposition.

5.3. *Effect of Interference on Fatigue Due to Load Applied Elsewhere.*—*Two or more bolts in line.*—Except in simple pin-lug joints, the conditions at bolted joints are more complex than in the present tests. For example, with two bolts in line the stress due to the load on the first bolt is superimposed, at the second hole, on the stress due to the load on the second bolt. Whatever the true explanation of the interference effect, it seems highly probable that interference fits would be beneficial; an extension of the experimental programme to investigate the cases of two or more loaded holes is under consideration.

5.4. *Application to Rivets.*—There is every reason to suppose that, in cold riveting, especially by the squeezing method of setting, the shank of the rivet can be distended under heavy pressure so as to produce the same condition as an interference-fit bolt or bush. Experiments are being planned to ascertain what improvement in fatigue strength may be obtained by extra-tight riveting.

5.5. *Effect of Built-in Stress on Static Strength.*—Tests have been arranged to show whether or not the use of bushes with 0.003 in. interference fit affects the static strength of lugs in aluminium alloy extrusions with longitudinal grain and poor cross-grain properties.

6. *Conclusions.*—Specimens loaded by a steel pin in double shear were tested under conditions corresponding with the R.A.E. standard fatigue-test loading for aircraft joints. Variation of the degree of interference fit had no appreciable effect up to a critical diametral interference of 0.003 in., at which value a sudden and remarkable improvement was obtained.

Specimens fitted with mild steel bushes having different degrees of interference fit in the hole gave a similar effect, although the loading pin was an easy push fit in the bush.

The use of bushed holes, with a sufficiently high interference, provides a method for greatly increasing the fatigue strength of aircraft joints without introducing difficulties of assembly.

The fatigue strength of single loaded holes, where sufficient interference is provided, is shown to be superior to that of more elaborately designed aircraft wing joints.

These results may be of far-reaching importance in the prevention of fatigue failure. But the effect of interference fit should be more fully explored and tests made to determine whether the pressure of the bush has any adverse effect on the static tensile strength of a lug made from extruded materials.

By using a suitable riveting technique, it should be possible to apply the same principle to riveted joints.

---

## REFERENCES

No.	Author	Title, etc.
1	M. M. Frocht .. .. .	<i>Photo-elasticity</i> , Vol. 2, p. 189. Wiley, New York. 1948.
2	Jackson and others .. .. .	The fatigue characteristics of bolted lap joints of 24S-T Alclad sheet materials. N.A.C.A. Tech. Note 1030. October, 1946.
3	W. A. P. Fisher .. .. .	Pre-tensioning for prevention of fatigue failure in bolts. <i>Aircraft Engineering</i> , Vol. 24, No. 280, p. 160. June, 1952.
4	W. A. P. Fisher and W. J. Winkworth ..	The effect of tight clamping on the fatigue strength of joints. R. & M. 2873. February, 1952.

TABLE 1

*Actual Dimensions of Test Specimens and  
Data on Fits of Individual Bushes  
Loaded Bushed Holes*

Specimen No.	Thickness (in.)	Width (in.)	Hole Diam. (in.)	Bush O/D. (in.)	Interference (in.)	Bush Assembly Load (Tons)	Pin Fit
1 A B	0.363	1.937 1.941	0.7494 0.7498	0.7525 0.7528	0.0028 0.0027	0.48 0.48	Push fit
2 A B	0.363	1.939 1.927	0.7501 0.7502	0.7526 0.7526	0.0025 0.0024	0.32 0.40	Push fit
3 A B	0.364	1.930 1.927	0.7499 0.7503	0.7525 0.7528	0.0026 0.0025	0.41 0.44	Sliding fit
4 A B	0.364	1.938 1.927	0.7501 0.7496	0.7518 0.7516	0.0017 0.0020	0.25 0.20	Sliding fit
5 A B	0.365	1.926 1.940	0.7496 0.7493	0.7516 0.7515	0.0020 0.0022	0.17 0.22	Push fit
6 A B	0.364	1.935 1.940	0.7501 0.7498	0.7517 0.7517	0.0016 0.0019	0.26 0.22	Sliding fit
7 A B	0.365	1.942 1.937	0.7503 0.7503	0.7513 0.7512	0.0010 0.0009	0.21 0.19	Push fit
8 A B	0.364	1.938 1.925	0.7500 0.7501	0.7509 0.7510	0.0009 0.0009	0.15 0.14	Sliding fit
9 A B	0.365	1.933 1.940	0.7499 0.7498	0.7507 0.7507	0.0008 0.0009	0.12 0.15	Sliding fit
10 A B	0.364	1.938 1.936	No bushes fitted				"
11 A B	0.364	1.928 1.938	Specimens tested with 0.75-in. diam. pins in plain holes				"
12 A B	0.365	1.938 1.928					"

TABLE 2  
*Loaded Bushed Holes*  
*Test Data*

Specimen No.	Bush interference (in.)	Location of failure	Remarks	Endurance (cycles)
1 A B	0.0028 0.0027	In plain section	Initial fatigue fracture at fretting mark clear of holes. <i>See Fig. 6</i>	3,650,600
2 A B	0.0025 0.0024	—	Specimen unbroken	20,891,500
3 A B	0.0026 0.0025	—	Specimen unbroken	21,282,700
4 A B	0.0017 0.0020	Hole B	Fatigued part of fracture is confined to one side, the other side being wholly static failure	411,800
5 A B	0.0020 0.0022	Hole B	Areas of fatigue fracture on both sides of the hole	532,400
6 A B	0.0016 0.0019	Hole A	Fatigued part of fracture confined to one side of hole	341,100
7 A B	0.0010 0.0009	Hole B	As for No. 6	517,000
8 A B	0.0009 0.0009	Hole A	As for No. 6	375,500
9 A B	0.0008 0.0009	Hole A	As for No. 6	385,700
10 A B	—	Hole A	} Fatigued areas on both sides of the hole on these specimens	514,200
11 A B	—	Hole B		220,300
12 A B	—	Hole A		239,800

*See Fig. 1 for diagram of specimen.*



TABLE 3

*Plain Loaded Holes—Test Data*

Specimen No.	Hole diam. (in.)	Pin diam. (in.)	Interference (in.)	Remarks	Endurance (cycles)
8	0.7501	0.7493	-0.0008		357,500
6	0.7505 0.7509	0.7510	0.0003		318,000
10	0.7500 0.7499	0.7504	0.00045	Failure through hole	318,600
1	0.7501 0.7499	0.7511 0.7510	0.00105	Fatigued areas on both sides of the hole	170,200
9	0.7503 0.7500	0.7513	0.00115	Slight fretting between pin and hole, near fractures	250,000
5	0.7501 0.7499	0.7515	0.0015		399,300
4	0.7501 0.7499	0.7520	0.0020		506,700
3	0.7499	0.7525	0.0026		517,500
7	0.7501 0.7499	0.7530	0.0030		783,000
2	0.7500 0.7499	0.7530	0.00305	Unbroken	13,586,800
12	0.7500 0.7499	0.7531	0.00315	Fracture through bolt hole	2,053,900
11	0.7500 0.7498	0.7533	0.0034	Unbroken	12,905,000

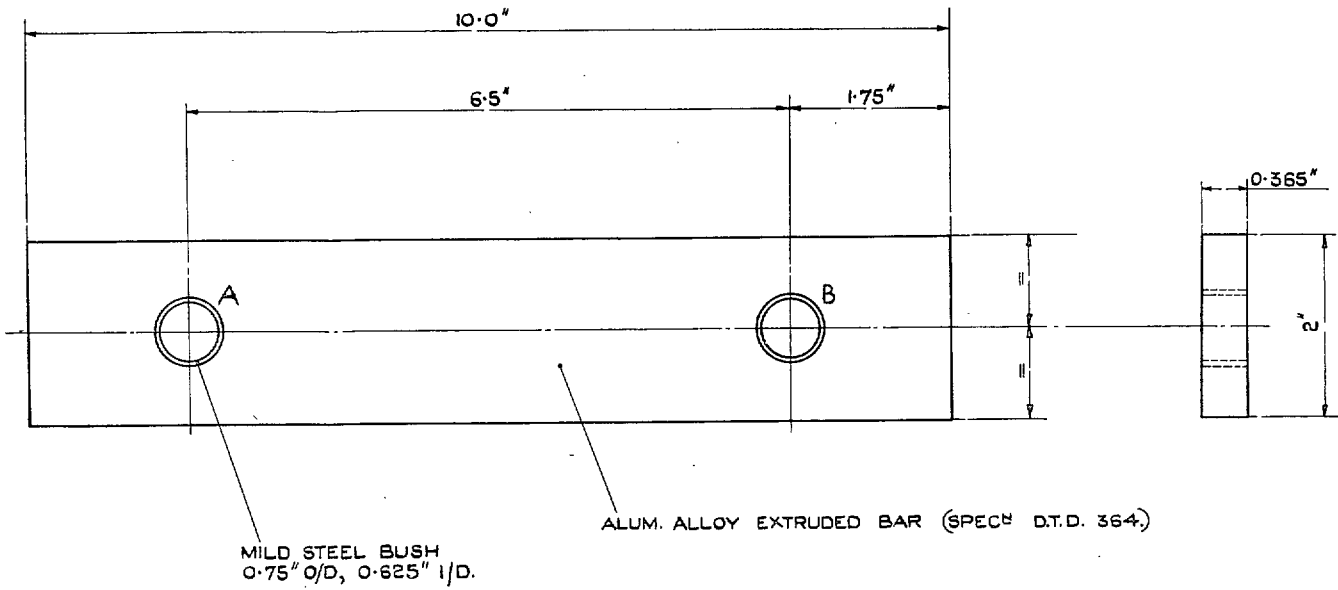

NOTE. THE ABOVE DIMENSIONS ARE NOMINAL  
ACTUAL DIMENSIONS OF INDIVIDUAL  
SPECIMENS ARE GIVEN IN TABLE I.

FIG. 1. Loaded bushed hole fatigue test specimen.

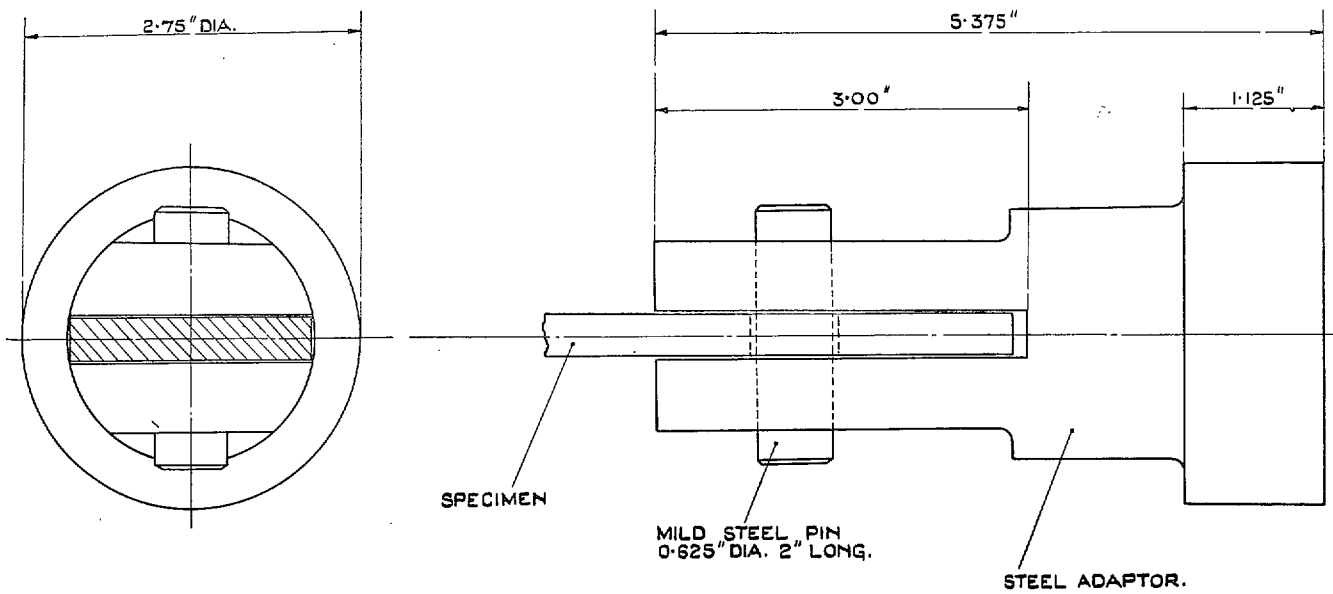

FIG. 2. Specimen adaptor fitting. Loaded bushed holes.

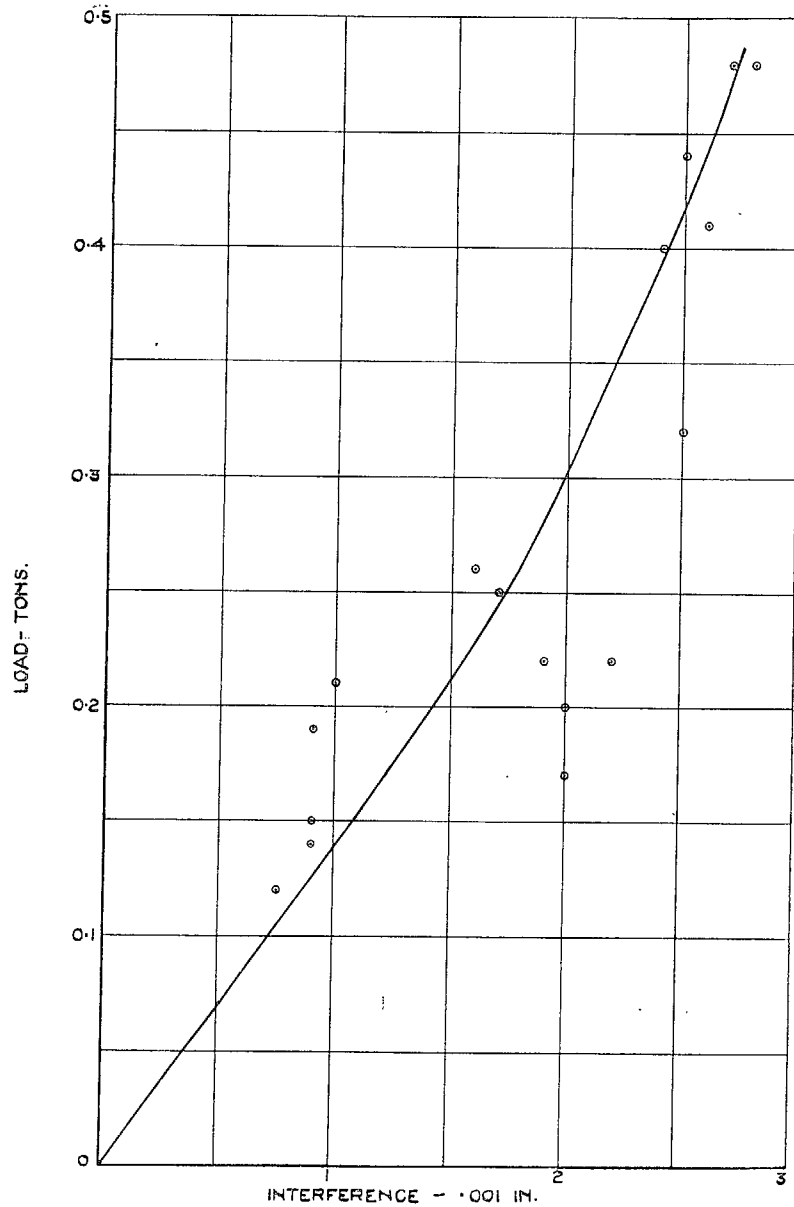

FIG. 3. Relationship between the load required to insert the bush and the interference between the bush and the hole. (Fatigue tests on loaded bushed holes.)

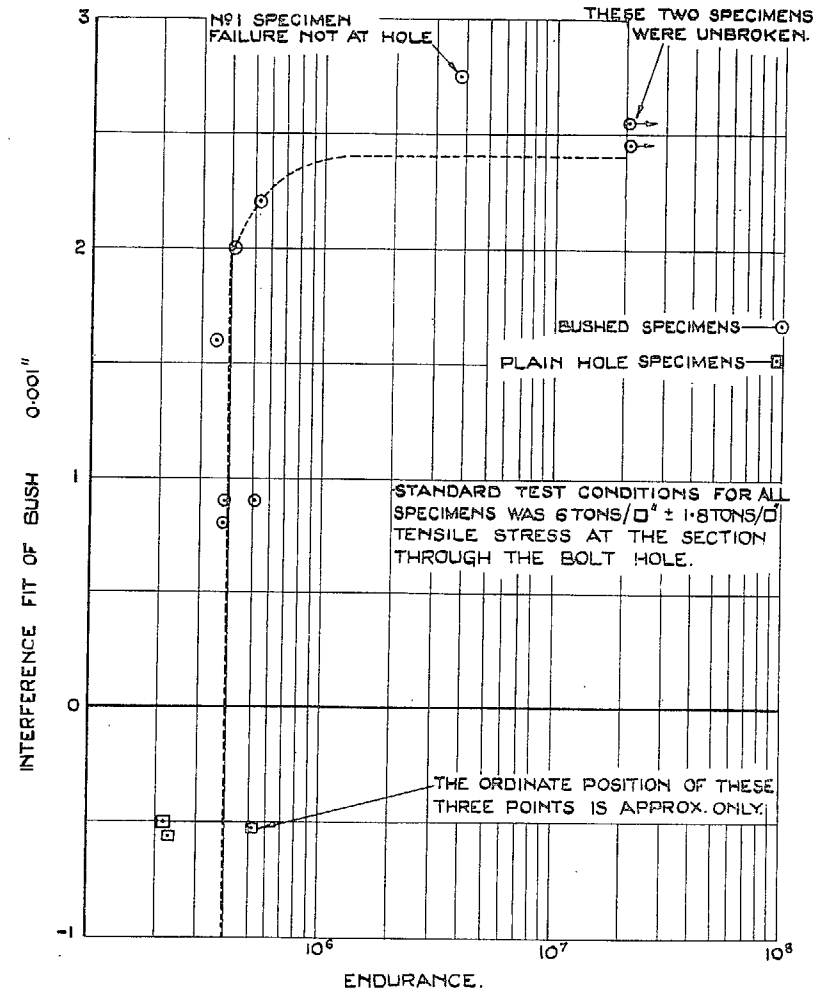

FIG. 4. Relation between degree of fit and endurance. Loaded bushed holes.

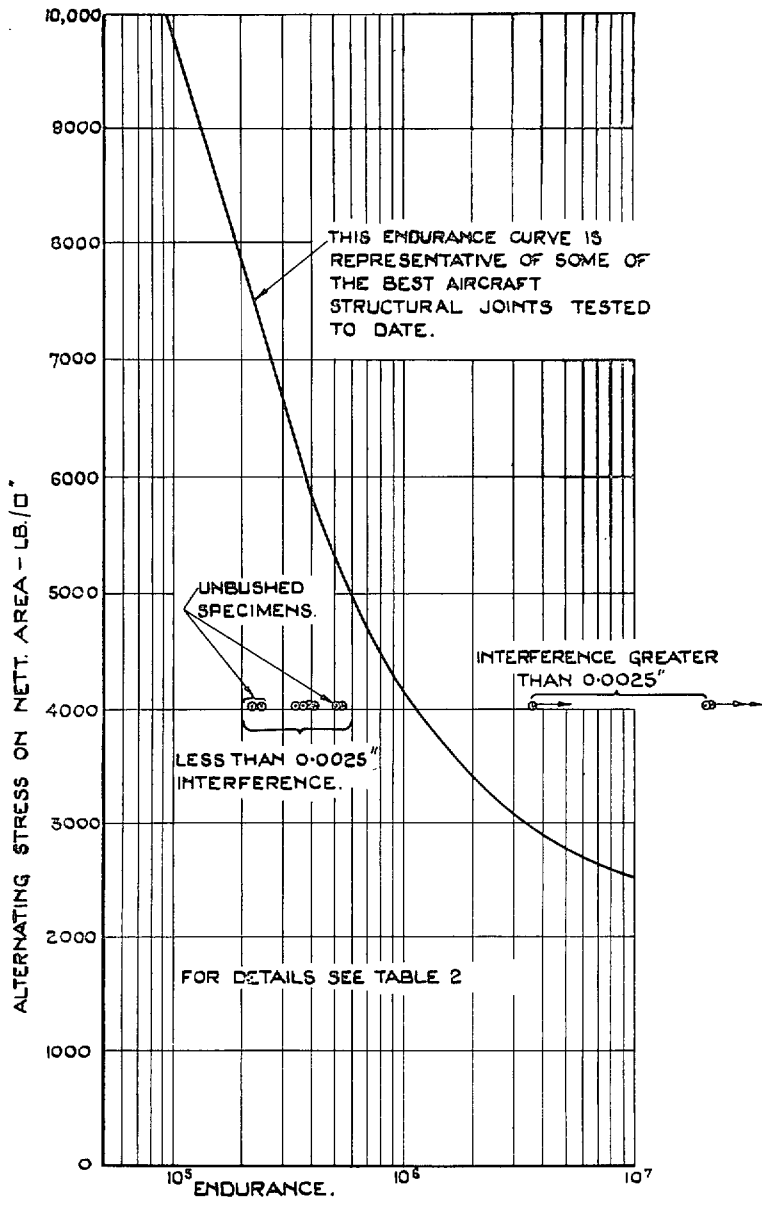
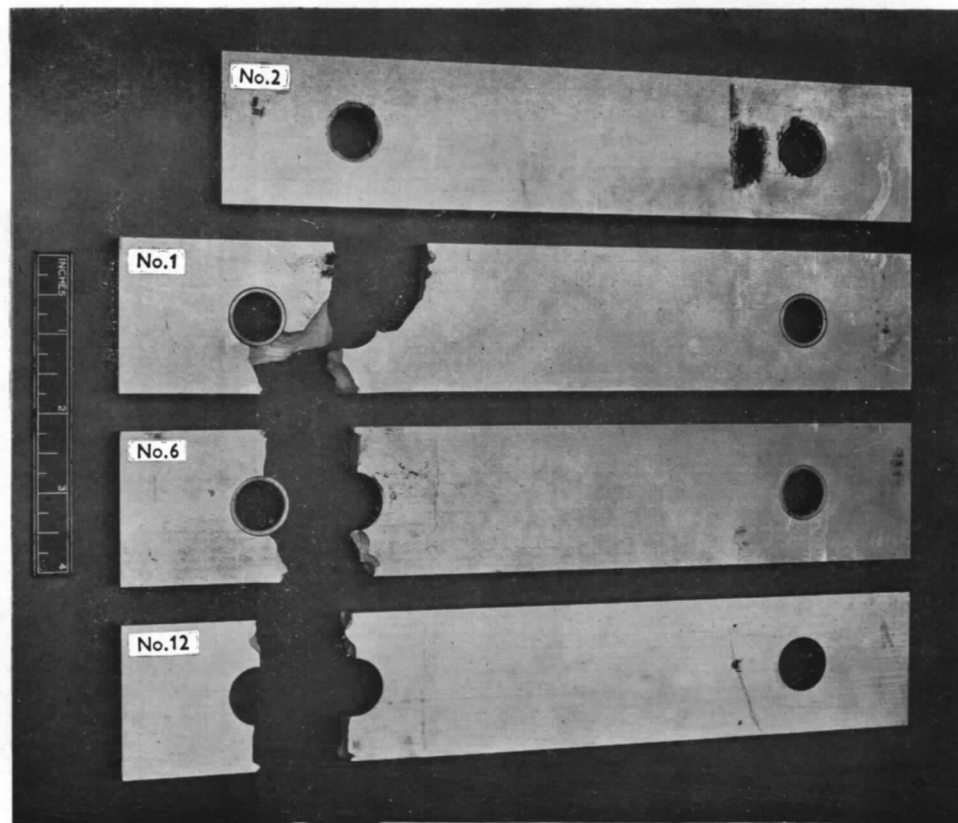

FIG. 5. Comparison of test results with similar data from aircraft structural joints of good fatigue strength. Loaded bushed holes.



SPECIMEN	INTERFERENCE BETWEEN BUSH & HOLE	ENDURANCE (CYCLES)
No.2	0-0025"	20,891,500
No.1	0-0028"	3,650,000
No.6	0-0016"	341,100
No.12	NO BUSH	239,800

FIG. 6. Failure of test specimens. Loaded bushed holes.

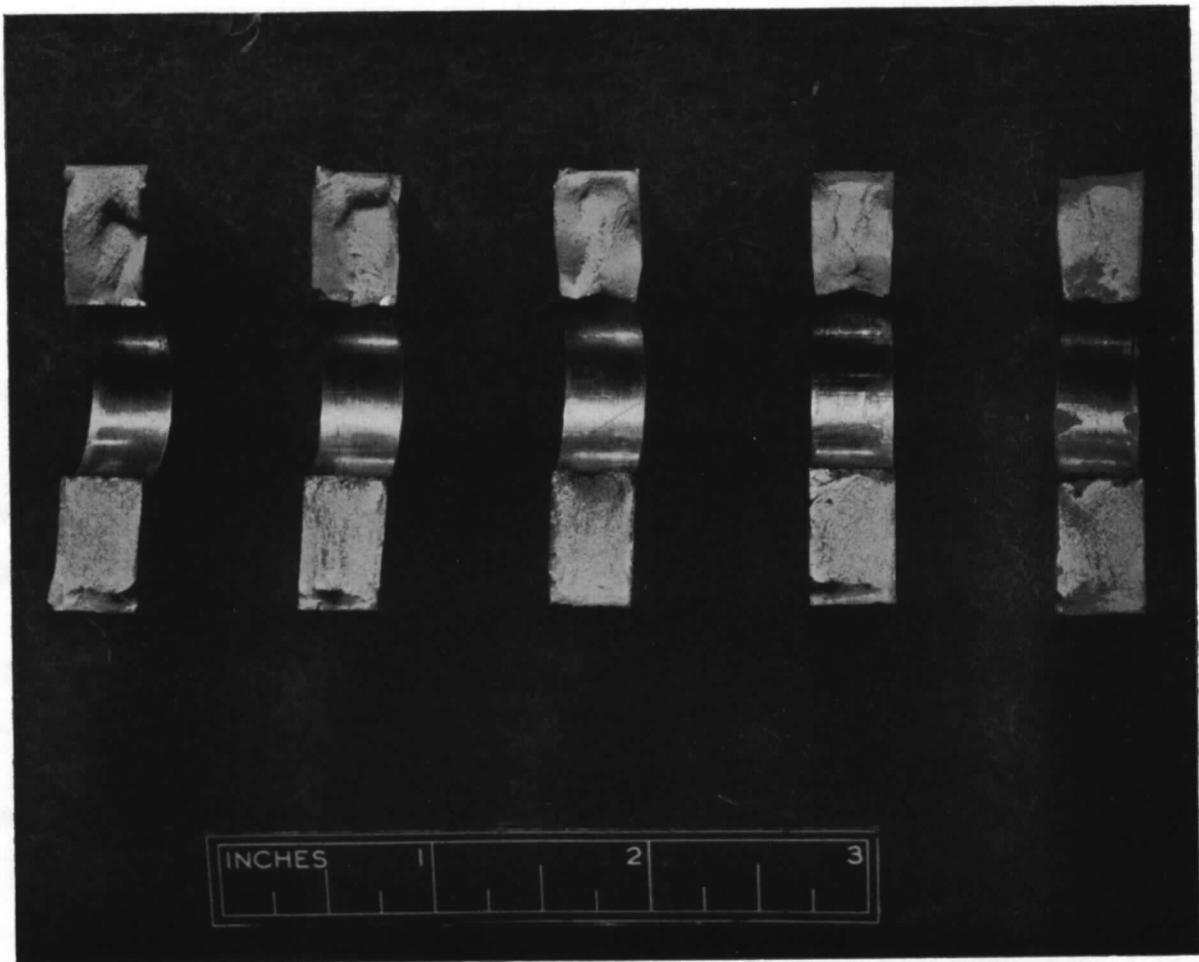

FIG. 7. Mode of fracture of bushed-hole specimens. Fatigued portion of fracture is confined to only one side of the hole. Loaded bushed holes.

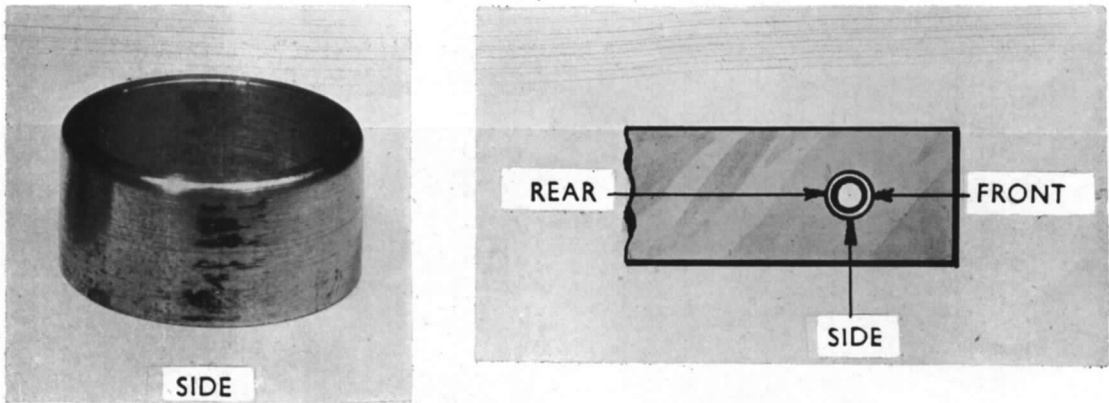

FIG. 8a. Small interference. 310,000 cycles.

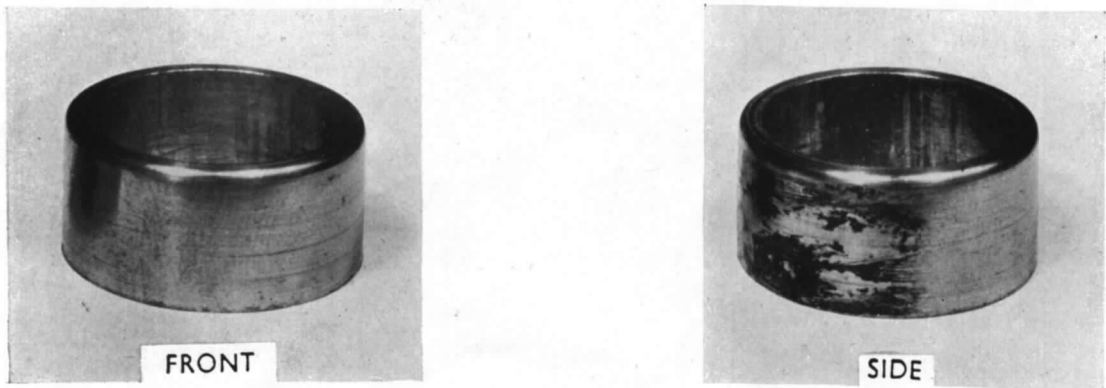

FIG. 8b. High interference fit over 12 million cycles.

FIGS. 8a and 8b. Comparison of fretting on bushes.

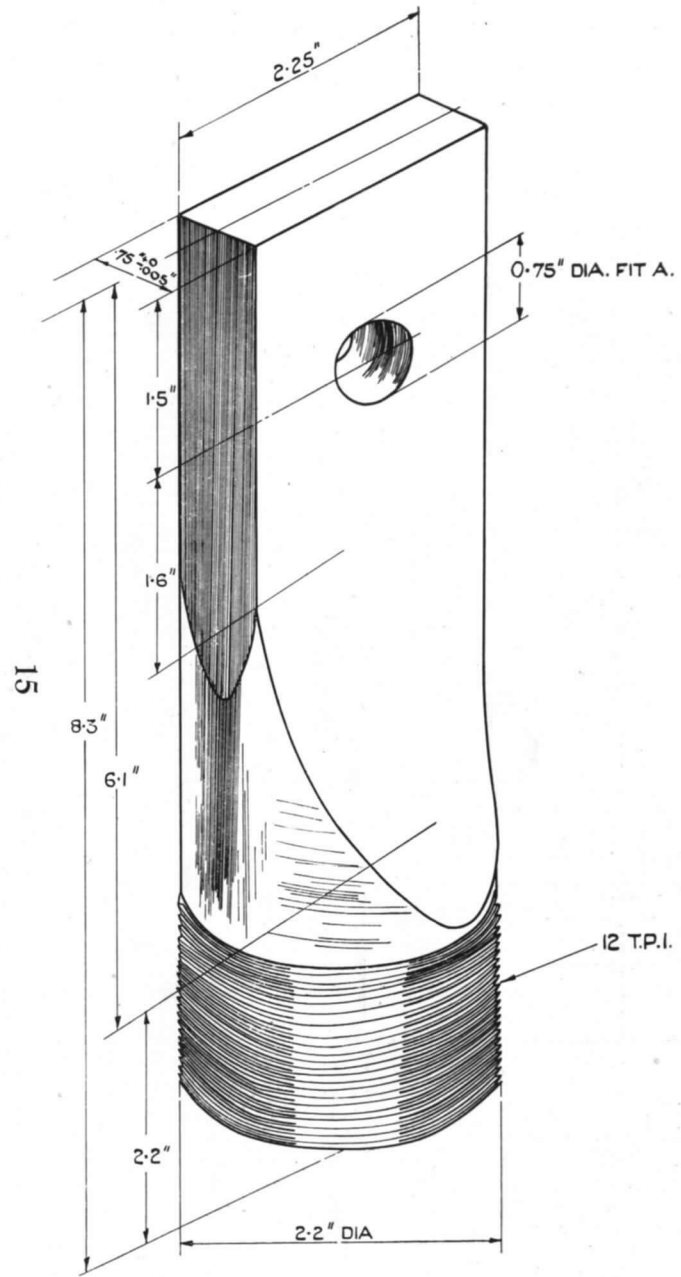

FIG. 9. Plain loaded hole fatigue test specimen

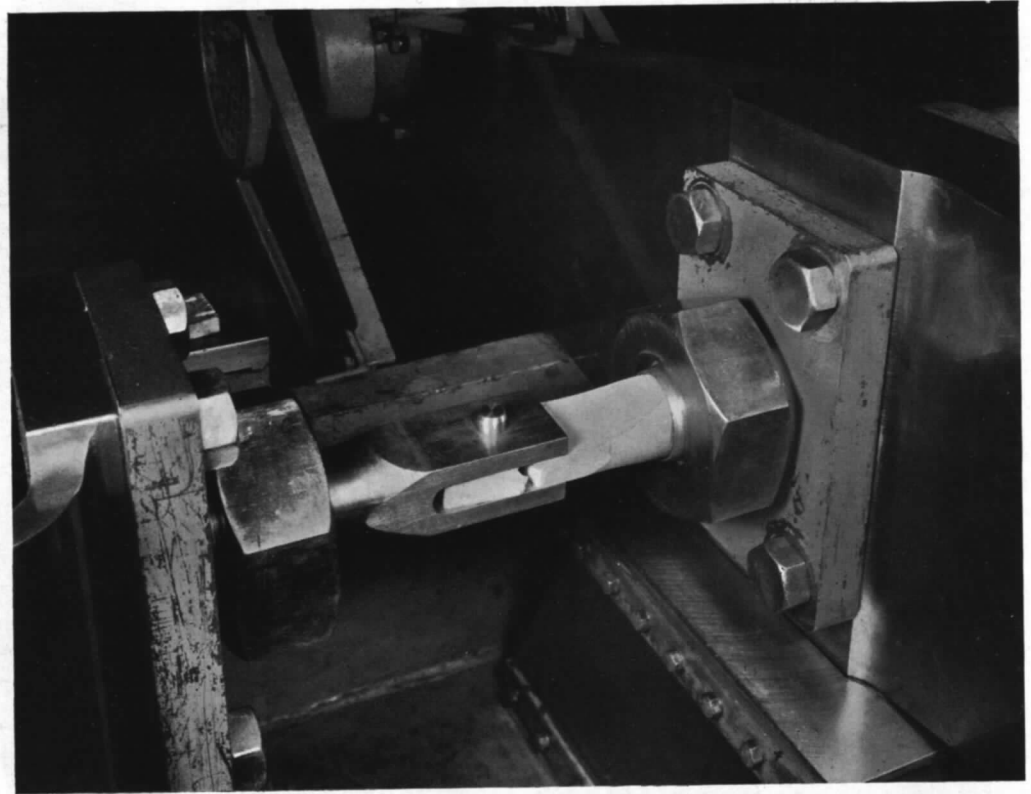

FIG. 10. Installation of test specimen in 20-ton Avery Fatigue Testing Machine. Plain loaded holes.



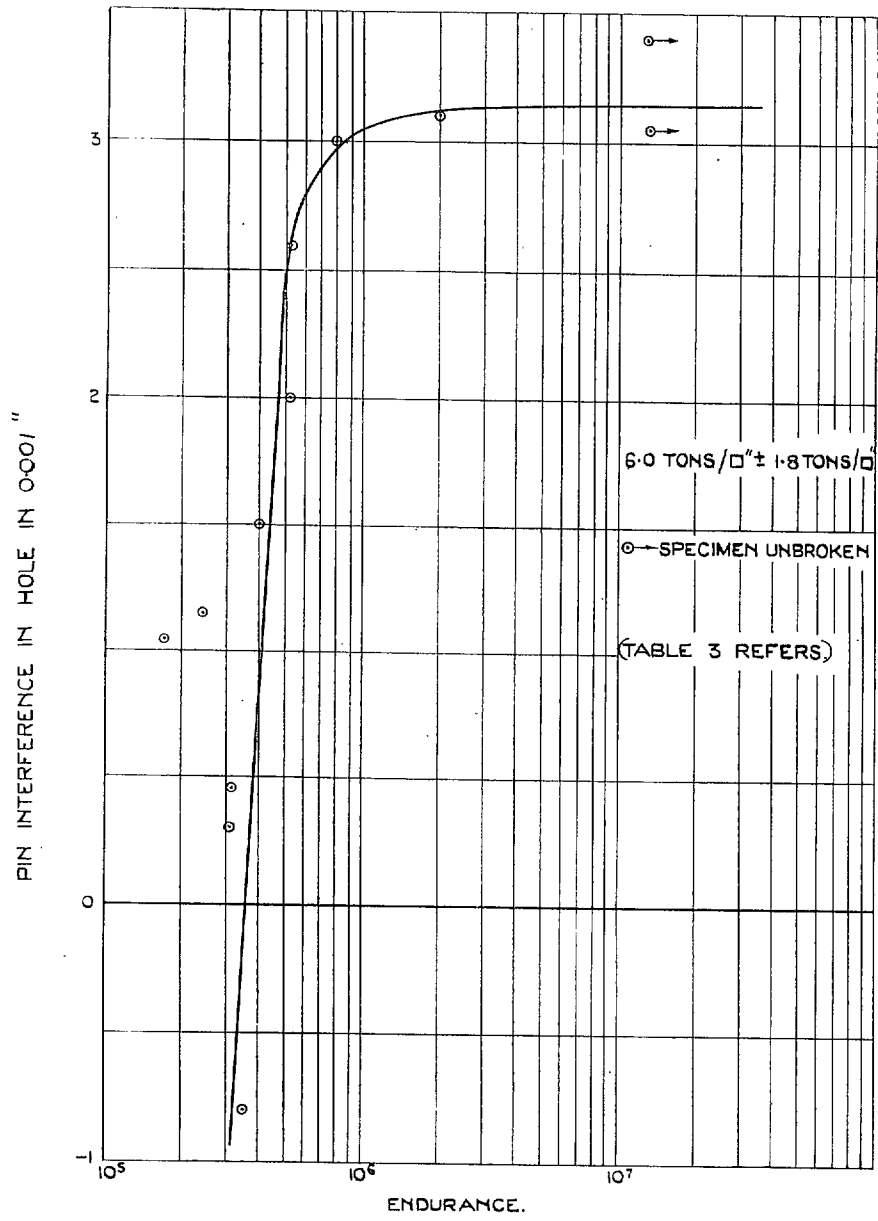

FIG. 11. Pin interference vs. endurance. Loaded plain hole fatigue tests.

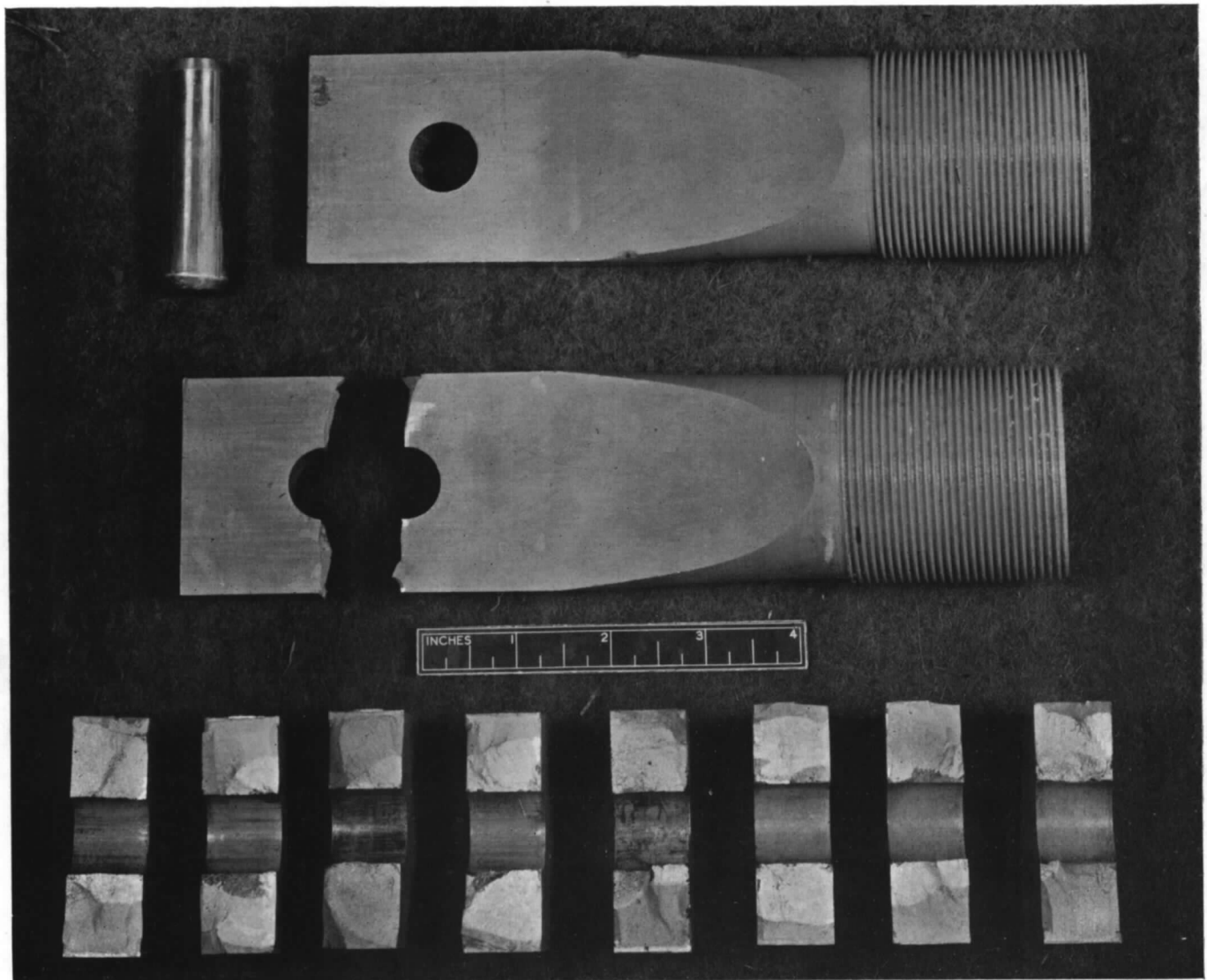

FIG. 12. Specimens after testing. Plain loaded holes.

# Publications of the Aeronautical Research Council

## ANNUAL TECHNICAL REPORTS OF THE AERONAUTICAL RESEARCH COUNCIL (BOUND VOLUMES)

- 1936 Vol. I. Aerodynamics General, Performance, Airscrews, Flutter and Spinning. 40s. (41s. 1d.).  
Vol. II. Stability and Control, Structures, Seaplanes, Engines, etc. 50s. (51s. 1d.)
- 1937 Vol. I. Aerodynamics General, Performance, Airscrews, Flutter and Spinning. 40s. (41s. 1d.)  
Vol. II. Stability and Control, Structures, Seaplanes, Engines, etc. 60s. (61s. 1d.)
- 1938 Vol. I. Aerodynamics General, Performance, Airscrews. 50s. (51s. 1d.)  
Vol. II. Stability and Control, Flutter, Structures, Seaplanes, Wind Tunnels, Materials. 30s. (31s. 1d.)
- 1939 Vol. I. Aerodynamics General, Performance, Airscrews, Engines. 50s. (51s. 1d.)  
Vol. II. Stability and Control, Flutter and Vibration, Instruments, Structures, Seaplanes, etc. 63s. (64s. 2d.)
- 1940 Aero and Hydrodynamics, Aerofoils, Airscrews, Engines, Flutter, Icing, Stability and Control, Structures, and a miscellaneous section. 50s. (51s. 1d.)
- 1941 Aero and Hydrodynamics, Aerofoils, Airscrews, Engines, Flutter, Stability and Control, Structures. 63s. (64s. 2d.)
- 1942 Vol. I. Aero and Hydrodynamics, Aerofoils, Airscrews, Engines. 75s. (76s. 3d.)  
Vol. II. Noise, Parachutes, Stability and Control, Structures, Vibration, Wind Tunnels. 47s. 6d. (48s. 7d.)
- 1943 Vol. I. Aerodynamics, Aerofoils, Airscrews, 80s. (81s. 4d.)  
Vol. II. Engines, Flutter, Materials, Parachutes, Performance, Stability and Control, Structures. 90s. (91s. 6d.)
- 1944 Vol. I. Aero and Hydrodynamics, Aerofoils, Aircraft, Airscrews, Controls. 84s. (85s. 8d.)  
Vol. II. Flutter and Vibration, Materials, Miscellaneous, Navigation, Parachutes, Performance, Plates, and Panels, Stability, Structures, Test Equipment, Wind Tunnels. 84s. (85s. 8d.)

## ANNUAL REPORTS OF THE AERONAUTICAL RESEARCH COUNCIL—

1933-34	1s. 6d. (1s. 8d.)	1937	2s. (2s. 2d.)
1934-35	1s. 6d. (1s. 8d.)	1938	1s. 6d. (1s. 8d.)
April 1, 1935 to Dec. 31, 1936.	4s. (4s. 4d.)	1939-48	3s. (3s. 2d.)

## INDEX TO ALL REPORTS AND MEMORANDA PUBLISHED IN THE ANNUAL TECHNICAL REPORTS, AND SEPARATELY—

April, 1950 - - - - R. & M. No. 2600. 2s. 6d. (2s. 7½d.)

## AUTHOR INDEX TO ALL REPORTS AND MEMORANDA OF THE AERONAUTICAL RESEARCH COUNCIL—

1909-1949 - - - - R. & M. No. 2570. 15s. (15s. 3d.)

## INDEXES TO THE TECHNICAL REPORTS OF THE AERONAUTICAL RESEARCH COUNCIL—

December 1, 1936 — June 30, 1939.	R. & M. No. 1850. 1s. 3d. (1s. 4½d.)
July 1, 1939 — June 30, 1945.	R. & M. No. 1950. 1s. (1s. 1½d.)
July 1, 1945 — June 30, 1946.	R. & M. No. 2050. 1s. (1s. 1½d.)
July 1, 1946 — December 31, 1946.	R. & M. No. 2150. 1s. 3d. (1s. 4½d.)
January 1, 1947 — June 30, 1947.	R. & M. No. 2250. 1s. 3d. (1s. 4½d.)
July, 1951 - - - -	R. & M. No. 2350. 1s. 9d. (1s. 10½d.)

*Prices in brackets include postage.*

Obtainable from

**HER MAJESTY'S STATIONERY OFFICE**

York House, Kingsway, London W.C.2; 423 Oxford Street, London W.1 (Post Orders: P.O. Box No. 569, London S.E.1);  
13A Castle Street, Edinburgh 2; 39 King Street, Manchester 2; 2 Edmund Street, Birmingham 3; 109 St. Mary  
Street, Cardiff; Tower Lane, Bristol 1; 80 Chichester Street, Belfast OR THROUGH ANY BOOKSELLER