



PROCUREMENT EXECUTIVE, MINISTRY OF DEFENCE

Aeronautical Research Council
Reports and Memoranda

FATIGUE BEHAVIOUR OF BS 2L65
ALUMINIUM ALLOY PIN-LOADED LUGS
WITH INTERFERENCE-FIT BUSHES

LIBRARY
ROYAL AIR FORCE INSTITUTION
BEDFORD
by

J.E. Moon

Structures Department, RAE Farnborough, Hants

London: Her Majesty's Stationery Office

£7 NET

FATIGUE BEHAVIOUR OF BS 2L65 ALUMINIUM ALLOY PIN-LOADED LUGS
WITH INTERFERENCE-FIT BUSHES

By J. E. Moon

Structures Department, RAE Farnborough, Hants

REPORTS AND MEMORANDA No.3835*

November 1977

SUMMARY

Cumulative fatigue damage has been studied in lugs with and without interference-fit bushes. Fatigue tests have been carried out under constant and variable amplitude loading conditions and local stress measurements have been made using the Companion Specimen Method.

Local stress measurements did not explain the large increase in life under constant amplitude loading associated with fitting an interference-fit bush in a pin-jointed lug, nor did they explain the reduction in life following a prestress on such a specimen. However, the stress measurements in sequences representing narrow band random loading were broadly consistent with actual fatigue test results, and enabled more accurate life estimations to be made at the lower mean stress tested, but at a high mean stress the measurements produced unsafe life estimates.

* Replaces RAE Technical Report 77177 - ARC 37872

LIST OF CONTENTS

		<u>Page</u>
1	INTRODUCTION	3
2	FATIGUE TESTS	4
	2.1 Material and specimens	4
	2.2 Fatigue tests and results	5
	2.3 Life estimations and comparison with achieved performances	7
3	LOCAL STRESS HISTORY MEASUREMENTS	7
	3.1 Method of measurement	8
	3.2 Material and specimens	8
	3.3 Summary of tests carried out	8
	3.4 Results	9
4	DISCUSSION	10
	4.1 Effect of passivating bushes	10
	4.2 The effect of an interference-fit bush on the life of a lug under constant amplitude loading	10
	4.3 The effect of a prestress on bushed and unbushed lugs under constant amplitude loading	12
	4.4 The performance of bushed lugs under narrow band random loading	14
5	CONCLUSIONS	17
	Appendix A Local stresses in a bushed lug	19
	Appendix B Fatigue testing facility and load spectra	20
	Appendix C Cumulative damage calculations made using Miner's Rule	21
	Appendix D Method of life estimation allowing for residual stresses	22
	Table 1 Chemical composition and tensile properties of BS 2L65 aluminium alloy	23
	Table 2 Fatigue test results	24
	Table 3 Fatigue test results	25
	Table 4 Fatigue test results	26
	Table 5 Fatigue test results	27
	Table 6 Fatigue test results	27
	Table 7 Fatigue test results	28
	Table 8 Fatigue test results	28
	Table 9 Fatigue test results	29
	References	30
	Illustrations	Figures 1-43
	Detachable abstract cards	-

1 INTRODUCTION

A lug loaded by a clearance fit pin is a structural feature which has a comparatively poor fatigue performance because fretting damage caused by relative movement between the pin and lug bore occurs at a position of high stress concentration and therefore leads to early crack initiation.

It has been found that the use of an interference-fit pin or bush can greatly improve this performance, at least under constant amplitude conditions¹. For ease of assembly and maintenance it is usual practice to employ an interference-fit bush with a clearance fit pin rather than just a force fit pin as the bush can be inserted into a sub-assembly whereas the pin has to be pressed into a final assembly. The interference creates a compressive radial stress and a tensile hoop stress in the lug in a similar manner to a cylinder under internal pressure and it is generally believed that there are two main reasons why an interference fit can improve the fatigue life of lugs². First, the frictional force created by the radial stress decreases the amount of slip between the hole bore and pin (or bush), and should therefore reduce the fretting damage. Second, there is a reduction in the tangential stress amplitude at the point of crack initiation. However, the interference does cause an increase in the local mean stress which can be damaging in fatigue, but this is generally assumed to be of only minor importance when compared with the reduction in amplitude. A fuller explanation of the effect of the bush on local stresses can be found in Appendix A.

The majority of research carried out investigating interference fits has used constant amplitude loading, as in Refs 1, 3 and 4, whereas components in service usually experience load spectra which are of variable amplitude and frequently random. It is well known that the use of constant amplitude loading in fatigue evaluation can give misleading results. For example, whereas there is a marked effect of fretting pad length on the life of a simple plain specimen under constant amplitude loading, the difference is greatly reduced under loading which simulates service conditions⁵. In addition Smith⁶ found that whereas a single tensile prestress applied to an unbushed lug before a constant amplitude fatigue test increased the life, the reverse was true for the case of a lug fitted with an interference fit bush. This implies that large load peaks in a random spectrum may have a much different effect on a bushed lug than one with just a clearance fit pin. It was therefore decided that in this programme, in addition to constant amplitude fatigue tests of bushed and unbushed lugs, both

would be tested under narrow band random loading to simulate service conditions in a simple way. This work is reported in section 2 which includes life predictions for the random loading cases using Miner's Rule.

It has been shown that in many cases more accurate life estimations can be made by considering the actual state of stress at the point of crack initiation, rather than net section stresses. Section 3 presents local stress history measurements in bushed and unbushed lugs using the Companion Specimen Method⁷ which were made in order to try to explain some of the observed fatigue behaviour and if possible to improve the life estimations made.

2 FATIGUE TESTS

All the results quoted for the unbushed lugs have been reported previously⁸, having been carried out as part of an earlier investigation. However, for completeness, a full description is given of the specimens and tests for both the unbushed and the bushed lug tests.

2.1 Material and specimens

All lugs, bushed and unbushed, were manufactured from bars of BS 2L65 aluminium alloy material obtained from one melt. The chemical analysis provided by the manufacturers and tensile properties obtained from test pieces cut from the same batch of material, are given in Table 1.

Fig 1 shows the unbushed lug specimen which was pin-loaded at each end. The same specimen was adapted to a bushed lug as shown in Fig 2 by enlarging one of the holes and fitting a bush to accept the same size of pin; in this form only the bushed hole was pin-loaded, the other end being clamped by wedge grips. As the bushed and unbushed lugs had the same gross cross-section and pin size they can be regarded as interchangeable components for the purpose of comparing fatigue performance.

The bush, shown in Fig 3, was made of S80 stainless steel and cadmium plated on its outer surface to prevent corrosion where the steel is in contact with the aluminium lug. For purposes of comparison, some bushes underwent a passivating process following plating, and some were untreated. The passivation process is normal practice following cadmium plating and gives greater resistance to corrosion. The bush had a nominal 0.27% interference in the lug, and in order to facilitate insertion, was placed on a mandrel and cooled in liquid nitrogen. The lug, preheated to 115°C was aligned in a jig below the bush and thus the possibility of scoring the hole bore was minimised.

Loading pins were manufactured from S94 steel, and in the case of the unbushed lugs had a diametral clearance of between 0.03% and 0.21% of diameter in the lug, while in the case of the bushed lugs the clearance in the bush was between 0.63% and 0.74% of diameter, the larger clearance being necessary to prevent seizure between the steel pin and bush.

2.2 Fatigue tests and results

All the fatigue tests were carried out on a modified Schenck resonant machine which was capable of applying either constant amplitude or narrow band random loading. Further details of the machine and waveforms applied are to be found in Appendix B. Loads were monitored throughout tests by measuring the root mean square value and displaying this on a pen recorder.

In this report stresses are quoted primarily in terms of

$$\text{Pin bearing stress} = \frac{\text{Load}}{\text{nominal pin diameter} \times \text{lug thickness}}$$

so that a direct comparison can be made between equivalent bushed and unbushed components carrying the same load. The use of net area stress is less satisfactory because the two types of lug have different net areas due to the presence of the bush and thus would sustain a different load for the same net stress; in addition, the designer is often concerned with pin loads in a joint design. However, to aid understanding and interpretation, values of net stress, based on the unbushed lug net area, are given in brackets following the pin bearing stress.

Fatigue tests on lugs fitted with interference fit bushes were carried out under the following loading conditions:

- (a) Constant amplitude loading over a range of stress amplitudes at two levels of tensile mean stress.
- (b) Constant amplitude loading following two values of prestress. A prestress is defined as a single large tensile stress applied at the beginning of the test and then reduced to the mean stress of the subsequent fatigue test.
- (c) Narrow Band Random (NBR) loading at two levels of tensile mean stress.

In the above tests the steel bushes were not passivated following cadmium plating, whereas it is normal practice in the aircraft industry to passivate bushes. In order to investigate the effect of this process further tests were carried out using lugs fitted with passivated bushes under:

- (d) Constant amplitude loading over a range of stress amplitudes at one tensile mean stress.
- (e) Narrow Band Random loading at two rms levels of alternating stress and one tensile mean stress.

Specimens were tested to failure or 10^7 cycles, whichever occurred first. Cracks were initiated by fretting between the bush and lug hole and led to failure through the net section. A typical failure is shown in Fig 4.

The following table details the locations of the tabulated results and associated S-N curves for each condition.

Form of Loading	Mean stress MN/m ²	Prestress MN/m ²	Bushes passivated	Table No.	Fig No.	Fig No. of comparison
Constant amplitude	153 (95)	0	No	2	5	} 10 } 11
" "	153 (95)	0	Yes	3	6	
" "	225 (140)	0	No	4	7	
" "	153 (95)	402 (250)	No	5		} 12
" "	153 (95)	474 (294)	No	6		
NBR	153 (95)	0	No	7	8	} 8 } 13
" "	153 (95)	0	Yes	8	8	
" "	225 (140)	0	No	9	9	

The S-N curves are based on a faired line passing as close as possible to the log mean endurance at each stress level. All failed specimens are indicated on these figures by a circle and dot, whilst a circle with an arrow indicates an unbroken specimen.

In Figs 10-13 where comparisons are made of results under different conditions, individual test points are omitted for clarity.

The unbushed lug data plotted in the comparison graphs, Figs 11-13, were obtained in an earlier investigation⁸ and only the faired S-N curves are presented in this report.

2.3 Life estimations and comparison with achieved performance

Miner's Rule is the most common method of predicting the life of components under service loading using data obtained in the laboratory under more simple loading, usually constant amplitude. Briefly, it sums linearly the damage accumulated by the various levels of alternating stress contained in the service spectrum. Miner's Rule was used to predict the lives of lugs under random loading using constant amplitude data, as described in Appendix C for the following cases:

- (a) NBR loading at 153 (95) MN/m² mean stress using constant amplitude data at that mean stress. The results for the passivated bushes data is plotted in Fig 14, along with the achieved performance curve.
- (b) As (a) but for the case of unpassivated bushes. As only one rms stress level was used at this mean stress the result is not plotted on an S-N diagram, but is included in Fig 16, which compares the accuracy of Miner's Rule for various conditions and will be explained later.
- (c) NBR loading at 225 (140) MN/m² mean stress using constant amplitude data obtained at the same mean stress. The results for unpassivated bushes are compared with the achieved performance in Fig 15.

The accuracy of Miner's Rule is usually judged by the ratio:

$$\sum \frac{n}{N} = \frac{\text{achieved life}}{\text{predicted life}}$$

Thus values of $\sum \frac{n}{N} > 1$ indicate a conservative or safe prediction, whereas values < 1 indicate an optimistic or unsafe prediction. The results of the calculations for the conditions (a), (b) and (c) were used to obtain values of $\sum \frac{n}{N}$, which are all plotted in Fig 16.

For comparison, values of $\sum \frac{n}{N}$ for unbushed lugs under NBR loading are plotted in Fig 17.

3 LOCAL STRESS HISTORY MEASUREMENTS

The interference modifies the initial stress state in the lug and it is widely believed that it also reduces the local stress amplitude at the point of crack initiation. It was therefore decided to study the local stress history in a bushed lug in order to aid understanding of the ways in which a bush can affect

the fatigue life of a lug. Theoretical analysis of the interference fit case is difficult, so it was decided to make direct measurements on the lug using the Companion Specimen Method⁷.

3.1 Method of measurement

Briefly, the Companion Specimen Method consists of reproducing on a plain specimen the stress and strain history at a position of stress concentration on another specimen. A strain gauge is attached at the point of interest in the latter specimen, generally where the fatigue crack is likely to start, and the strain history is recorded whilst the specimen is subjected to the desired load sequence. The recorded strain sequence is then applied to a plain specimen, made of the same material as the component, and by measuring the loads applied, the corresponding stress history in the component is determined.

3.2 Material and specimens

All lug and plain specimens were cut from 2 bars of BS 2L65 aluminium alloy from the same melt as those used in the fatigue test programme. The lug specimen is shown in Fig 18 and the bush of S80 steel material in Fig 19. At one end of the lug the hole was enlarged to accept a bush having a 0.27% (0.076 mm) diametral interference, to be loaded by a 25.4 mm diameter pin. The other end was machined to take the pin alone without the bush to enable a direct comparison to be made between a bushed hole and an equivalent unbushed hole. Thus the specimen represented exactly the bushed and unbushed lugs used in the fatigue test programme. The strain gauges in both holes were placed as shown in Fig 18, mid-way through the thickness of the lug. In order to clear the gauge the bush had a hole drilled in its centre and was split, half being inserted from each side, see Fig 19. The gauge was attached to the lug before inserting the bush, in this way the strain due to the bush alone could be measured. The loading pins had a slot milled along their length to accommodate the gauge leads in the bushed hole, and both the gauge and its leads in the unbushed hole. The plain specimen is shown in Fig 20.

3.3 Summary of tests carried out

The load sequences employed, shown in Fig 21, were designed to represent, in a simple way, the essential features of the fatigue tests reported in section 2, as it was hoped that the Companion Specimen data could be used to aid interpretation of the fatigue test results.

Sequence (a) was designed to investigate the effect of prestress on local stress during subsequent constant amplitude loading. It represented tests at an rms alternating stress of 64 (40) MN/m² and a mean of 153 (95) MN/m² with three nominal values of prestress:

- (1) 0
- (2) 402 (250) MN/m²
- (3) 474 (294) MN/m²

Previous experience using the Companion Specimen Method on a similar material indicated that applying the two prestresses in sequence would not have produced a different result to applying them separately on virgin specimens.

Sequence (b) was designed to represent narrow band random loading at 153 (95) MN/m² mean stress. Section 2 presented results of fatigue tests at two levels of rms alternating stress under these conditions and this sequence enabled the local stress behaviour to be compared before and after a load representing the highest peak in each spectrum.

Sequence (c) was similar in principle to sequence (b) except that it was designed to help interpret random fatigue tests carried out at a mean stress of 225 (140) MN/m².

3.4 Results

Fig 22 is a typical example of a graph for a bushed hole of local strain vs pin bearing stress, this particular plot being for a specimen loaded through sequence (a), simulating the prestressed constant amplitude tests. The corresponding local stress vs local strain diagram obtained from a plain specimen is shown in Fig 23. For comparison Fig 24 shows a pin bearing stress vs local strain diagram obtained from an unbushed hole under the same conditions, and Fig 25 is the corresponding local stress vs local strain diagram. These graphs, along with similar ones for the other sequences were analysed in order to obtain the local stress range and local mean stress during each load cycle. These results were then used to construct the following graphs:

Figs 26 and 27 - Comparison of local stress histories in a bushed and an unbushed lug under constant amplitude loading, at 2 mean stresses.

Fig 28 - The effect of a prestress on local stress histories in a bushed and an unbushed lug under constant amplitude loading.

Figs 29-33 - The effect of peak stress in a random spectrum on local stress histories during subsequent smaller net stress cycles, at 2 mean stresses and several rms alternating stresses.

4 DISCUSSION

4.1 Effect of passivating bushes

It is normal practice, when using a steel bush in an aluminium alloy lug, to cadmium plate the bush. Plating is usually followed by a passivation process, which consists of dipping the bush in a solution that deposits a fine chromate layer on the cadmium plating, in order to give a greater resistance to corrosion. Most of the bushes used in this programme were cadmium plated but not passivated; however a limited number were treated in order to assess the effect of passivation.

Fig 10 shows only a small effect of passivation on life under constant amplitude loading over most of the alternating stress range. The most significant effect was at the longer endurance, where the fatigue strength was reduced by about 45% in the passivated case. This effect was probably due to an increase in fretting damage brought about by the hard chromate particles deposited in the passivation process.

Only a limited number of specimens were available to assess the effect of passivation under NBR loading. The results, presented in Fig 8, did not show any significant effect. However, an insufficient number of specimens were tested to draw any definite conclusion. The possibility that passivation affects the fretting damage would be less under random loading, as large load peaks in the spectrum are likely to cause earlier crack initiation than under constant amplitude loading.

4.2 The effect of an interference-fit bush on the life of a lug under constant amplitude loading

When comparing the behaviour of bushed and unbushed lugs, it should be remembered, as stated in section 2.1 that the unbushed lugs were double ended, whereas the bushed lugs were pin-loaded at one end only. Thus, in the unbushed case, failure occurred at the weaker of two holes. This caused a slight lowering of the log mean life, but it is considered that this was of only small magnitude, because of the small scatter exhibited by pin-loaded lugs.

Fig 11 shows log mean endurance curves for lugs with and without bushes. Comparing the bushed and unbushed performance first at the lower mean stresses, which were similar in the two cases, it will be noted that the effect of the interference was to increase fatigue life considerably, which is in accordance with the findings of other workers^{1,2,3,4}. It should be pointed out that the

curve presented for the bushed lugs is for the case of passivated bushes. The effect of increasing the mean stress was to reduce performance of both the bushed and unbushed lugs, the effect being much more damaging in the bushed case even though the change in mean stress was less. Furthermore, whereas the S-N curves for the unbushed lugs at the two mean stresses tended to converge at long endurance, this was not so for the bushed lugs and the increased mean stress caused a reduction of about 64% in fatigue strength at around 4×10^6 cycles. The reduction was so great that the S-N curve for the bushed lugs crossed over both unbushed curves. This result was checked by testing 4 unbushed lugs at 225 (140) MN/m² mean stress and an rms alternating stress of 8 (5) MN/m². None of the unbushed specimens failed after 10^7 cycles, whereas 4 bushed specimens had all failed with a log mean endurance of 5×10^6 cycles at the same stress level, confirming that bushed lugs had an inferior performance to the unbushed lugs at 225 (140) MN/m² mean stress and low alternating stress. It was found that the main effect of passivating bushes under constant amplitude loading at the low mean stress was to reduce the fatigue strength at long lives. As the increased mean stress reduced this strength to a very low value it seems probable that passivating bushes would have little if any effect at the high mean stress.

Reference can now be made to the local stress measurements to see if they explain the observed fatigue behaviour. From the changes in local stress during the first occurrence of each magnitude of stress cycle in sequence (b) and (c) of Fig 21, the local mean stress and stress range can be calculated for bushed and unbushed lugs over a range of alternating stresses at the two mean stresses. This information can be found in Figs 26 and 27. This shows that in general, during any net stress cycle, the local stress history in the bushed lug displayed a higher mean stress and a lower alternating stress than the unbushed lug, which agrees with the ideas put forward in the introduction.

The next step was to quantify these findings in terms of effect on life. In order to construct a local mean-local alternating stress diagram for unbushed lugs over a range of fatigue lives, an S-N curve had to be constructed for unbushed lugs at 225 (140) MN/m² mean stress. This was done by using the results of constant amplitude tests at three mean stresses⁸ to draw Fig 34 which is a net alternating-net mean stress diagram for unbushed lugs. The constructed S-N curve derived from this is shown in Fig 37 as the dotted line. The local stress diagrams for constant amplitude loading in Figs 26 and 27 can then be used with the unbushed S-N curves to construct the local mean-local alternating stress

diagram of Fig 35. The local stress diagrams of Figs 26 and 27 were then used with this mean-alternating stress diagram to estimate the lives of the bushed lugs over the range of net stresses applied. These estimates are plotted along with the achieved bushed and unbushed performances in Figs 36 and 37.

Considering first Fig 36, which compares the estimated and achieved performances at mean stress = $153 (95) \text{ MN/m}^2$ it can be seen that the local stress measurements predicted that fitting a bush would produce a small improvement in endurance over an unbushed lug, typically increasing endurance by a factor of 1.5-2. However, the actual achieved performance of a bushed lug was approximately 6-7 times greater than an unbushed lug over most of the alternating stress range. The predicted and achieved performance curves only converged at low alternating stresses. Thus, although the local stress measurements predicted that an interference fit bush should give rise to some improvement in life, the actual achieved performance was much greater. A possible explanation is that the interference did reduce fretting damage significantly, and this is the main reason for the large increase in endurance observed in fatigue tests.

Turning next to Fig 37, which is similar to Fig 36 just described, except that the mean stress was $225 (140) \text{ MN/m}^2$, it will be noted that the local stress measurements predicted that the bush would increase endurance of the unbushed lug by a small amount over all the stress range. Again the predictions were in poor agreement with the observed fatigue behaviour. At higher alternating stresses the bushed lug demonstrated a large increase in performance, which was possibly due to the reduced fretting damage. However, at low alternating stresses the performance of the bushed lugs was inferior to that of the unbushed lugs despite the fact that local stress measurements indicated that the reverse should have occurred. This is difficult to understand and does not support the earlier supposition about the reduced effect of fretting.

4.3 The effect of a prestress on bushed and unbushed lugs under constant amplitude loading

As stated earlier, it has already been established by several workers that the use of an interference fit bush can improve the fatigue life of lugs under constant amplitude loading. The main purpose of this programme was to investigate the effects of bushing under variable amplitude loading. Smith⁶ has reported that whereas a single tensile prestress applied at the beginning of a fatigue test could improve the life of an unbushed lug, the reverse was true for the case of a bushed lug. This result implies that large load peaks in a

variable amplitude spectrum may have a much different effect on a bushed lug from that on one with just a clearance fit pin. It was decided to check Smith's results on the particular lug used in this investigation. Two levels of prestress were applied to bushed lugs at one level of rms alternating stress. Results were available from an earlier investigation⁸ for unbushed lugs with similar levels of prestress. Fig 12 compares the behaviour of the bushed and unbushed lugs subject to a prestress. The constant amplitude curves for no prestress have been drawn for both bushed and unbushed lugs, and are compared with log mean endurance at one level of rms alternating stress for the prestressed results. It can be seen that a prestress had opposite effects on bushed and unbushed lugs, repeating Smith's findings. In the case of the unbushed lug, a prestress increased fatigue life, the larger the prestress, the larger the increase. However, the effect of a prestress on a bushed lug was to reduce life, the larger the prestress, the greater the reduction. It should be noted that the prestresses applied were fairly large, being approximately in the range 0.5-0.6 of the ultimate tensile strength.

Sequence (a) used in the local stress measurements, shown in Fig 21, was designed to investigate the effect of two levels of prestress on local stress during subsequent constant amplitude loading, and the results are plotted in Fig 28 which shows the effect of the prestresses on local stress range and local mean stress. Considering first the effect of prestress on an unbushed lug it can be seen that the local stress range was virtually unaffected by both values of prestress. However, the mean stress was reduced by 57% and 93% respectively by the two values of prestress. This behaviour is attributed to the creation of compressive residual stresses following local tensile yielding which led to the observed increase in fatigue life. This is a well known phenomenon and there are design codes, such as the ESDU rule⁹ which can be used to take account of it in life prediction. Turning next to the case of the bushed lug the two values of prestress increased the local stress range by 7% and 11% respectively. Reference should again be made to Appendix A for an explanation of this effect. The local mean stress was reduced slightly more than in the case of the unbushed lug. The beneficial effect of reduced mean stress would be expected to oppose the detrimental effect of the increased stress range. Taking the case of the higher prestress and using fatigue test data presented in this report, the observed 11% increase in stress amplitude would be expected to reduce the life by about 40%. However, the reduction in mean stress in the case of the unbushed lug caused an

increase in endurance of 160%. As there was a greater reduction in mean stress for the case of the bushed lug, an equal, if not greater effect on life would be anticipated which would more than offset the effect of the increase in stress range. As the fatigue tests showed a reduction in life following a prestress, this cannot be attributed to the change in local stress conditions described above. Other possible explanations include:

- (i) An increase in fretting damage caused by a relief in radial stress.
- (ii) The presence of very high stress gradients such that the strain gauge was not responding to the true local stress situation.

Both these points are currently being investigated using the Moiré Fringe Method. This will give the in-plane surface strains on the lug following bush insertion and will study the effect of several values of preload.

4.4 The performance of bushed lugs under narrow band random loading

The performance of bushed and unbushed lugs was also compared under NBR loading at different mean stresses. It should be noted that the use of a resonant machine for this evaluation is not entirely satisfactory because for a given level of alternating stress, the amplitude distribution tends to vary with mean stress and specimen type. This is due to the large change in stiffness of the double pinned lug as the load passes through zero during large negative-going amplitudes, resulting in truncation of the largest amplitudes, and it follows that truncation of the high alternating stresses will be more pronounced for low values of mean stress.

Fig 13 indicates that whereas there is only a very small effect of mean stress on unbushed lugs, there is a pronounced effect on bushed lugs; this is similar to the results under constant amplitude loading. However, the question of relative sensitivity of constant amplitude and NBR performance to mean stress level is more accurately examined by studying life predictions based on load spectra which were actually achieved, and using the appropriate constant amplitude data.

As outlined in section 2.3, Miner's Rule was used to estimate the endurance of the lugs. The predictions for the bushed lugs are plotted along with the achieved performances in Figs 14 and 15. These results were used to plot Fig 16, which presents values of $\sum \frac{n}{N} \left[= \frac{\text{achieved life}}{\text{predicted life}} \right]$ under all conditions. It will be noted that under most conditions Miner's Rule using nominal stresses was

conservative, the exception being for the case of the unpassivated bushes at the lower mean stress where $\sum \frac{n}{N}$ was just less than one. Similar results are plotted in Fig 17 for unbushed lugs, which shows $\sum \frac{n}{N}$ varying from 1.5-4.75 for the cases considered. Thus Miner's Rule was generally conservative for both bushed and unbushed lugs under NBR loading.

Referring to the earlier discussion of the effect of mean stress; similar values of $\sum \frac{n}{N}$ were obtained at the two mean stresses and therefore as there was a large effect of mean stress under constant amplitude loading it follows that there is a similarly large effect under NBR loading. This contrasts with the behaviour of unbushed lugs which exhibit only a small effect of mean stress under both constant and variable amplitude loading⁸.

Local stress measurement sequences (b) and (c) of Fig 21 were designed to look at the local stress histories in bushed and unbushed lugs under simulated random loading. Considering first sequence (b) which simulates NBR loading at a mean stress of 153 (95) MN/m², the local stress history measurements for this sequence are presented in Figs 29 and 30. These figures show the effect of the largest peak stress in a fatigue test at two particular rms stress levels, on subsequent smaller cycles in the spectrum. Thus the local stress ranges and local mean stresses are plotted for the case before and after the largest peak stress. The effects observed in general were not as great as for sequence (a) described earlier, although similar basic trends can be identified as follows:

(i) Effect on local mean stress

The peak stress in the spectra reduced the local mean stress of subsequent smaller cycles by inducing compressive residual stresses. The reduction was generally not as great in the bushed case as in the unbushed one. Due to this effect alone, Miner's Rule would be expected to be conservative for both bushed and unbushed lugs, although $\sum \frac{n}{N}$ would be slightly higher for the unbushed lug.

(ii) Effect on local alternating stress

The peak stress had only a small effect on stress range for both bushed and unbushed lugs, which would not be expected to affect significantly the life prediction of either lug.

As these local stress measurements were broadly consistent with the observed fatigue behaviour it was decided to use them to make modified predictions of the fatigue lives. This was done by adjusting the constant amplitude S-N curve

used in the calculations, allowing for the reduction in mean stress. The method adopted is described more fully in Appendix D. For the case of mean stress = 153 (95) MN/m² the method was only applied to the tests using passivated bushes, since this is the normal practical situation. The results are summarised in Fig 38 which presents values of $\sum \frac{n}{N}$ over the alternating stress range tested. It can be seen that the life predictions were more accurate than those in which no allowance was made for residual stresses, although at the higher rms stress the estimate was on the unsafe side, $\sum \frac{n}{N}$ being 0.75.

Turning next to sequence (c), which simulated NBR loading at a mean stress of 225 (140) MN/m², the results of the local stress measurements are presented in Figs 31-33, each figure representing a random spectrum at a particular rms alternating stress level. Thus each figure shows the effect of the peak stress at a particular rms stress level on the local stress histories during subsequent smaller load cycles:

(i) Effect on local mean stresses

Before the application of the peak stress, the mean stress in the bushed lug was slightly higher than that in the unbushed lug for the same net stress range due to the initial interference hoop stress. It can be seen that at all three rms stress levels the peak stress in each spectrum reduced the local mean stress under subsequent loading in both the bushed and unbushed lugs. The reduction was approximately the same in both cases, and was larger for the higher rms stress levels. Therefore, due to this effect alone, Miner's Rule would be expected to be equally conservative for both bushed and unbushed lugs.

(ii) Effect on local alternating stress

At all three stress levels the peak stress in the spectrum had a small effect on local stress range during smaller cycles. The effect was minimal in the unbushed lugs, but in the bushed lug there was a tendency for the local stress ranges for the lower net stresses to be increased slightly. Typically the local stress range was increased by 5-10% for the lowest two or three net stress ranges. This would have a detrimental effect on fatigue life but this would probably be considerably smaller in magnitude than that caused by the mean stress reduction.

These local stress measurements were used to estimate the fatigue endurance, making allowance for the reduction in mean stress, in a similar manner to that employed for the results of sequence (b). The resultant $\sum \frac{n}{N}$

values are plotted in Fig 38, which shows that the estimates lay well over on the unsafe side, $\sum \frac{n}{N}$ varying from 0.12 to 0.75. It should be noted that it was assumed in the calculations, when constructing the local mean-local alternating stress diagram, that the bushes were passivated. Thus these predictions were less satisfactory than those in which no allowance was made for residual stresses, particularly because conservative estimates became unsafe.

There are several possible reasons for these poor estimates of life, which include the following:

- (a) The method employed to adjust the basic S-N data for the life estimation, allowing for residual stresses, may have been in error, particularly in the construction of the local mean-local alternating stress diagrams where a Goodman-type straight line relationship was assumed. However, it should be noted that the same assumption was made for the lower mean stress results using sequence (b), and reasonably accurate estimates resulted.
- (b) At the high mean stress employed in these tests, the largest load peaks may have effectively loosened the bush leading to an increase in fretting damage and thus earlier crack initiation. It will be recalled that a large prestress applied at the start of a constant amplitude fatigue test decreased life and a similar mechanism was postulated to explain the result. At the higher rms stresses the peak load in the random sequence was of a similar magnitude to the prestresses applied before the constant amplitude test. Fig 38 shows that the estimates became more unsafe for the higher levels of rms alternating stress and thus higher peak loads, which is consistent with the finding that the greater the prestress, the greater the reduction in constant amplitude life.

5 CONCLUSIONS

Studies of cumulative fatigue damage have been made comparing lugs with and without interference-fit bushes by carrying out fatigue tests at tensile mean stresses under constant amplitude and narrow band random loading conditions and making local stress history measurements using the Companion Specimen Method. The observed fatigue behaviour was only partly explained by the local stress measurements. The following observations were made:

- (i) Under constant amplitude loading the bush effectively reduced the amplitude and increased the mean value of the local stress. Although only a small effect on fatigue endurance would be expected, a large increase in endurance was observed under all conditions tested apart from the case of a high mean stress with a low alternating stress. It seems possible that the reduction in fretting damage caused by the presence of the bush was an important factor but does not explain the single above-mentioned case.
- (ii) The effect of tensile prestress on the unbushed hole was to reduce considerably the local mean stress, and the expected increase in endurance under constant amplitude loading was observed. When the same prestress was applied to the bushed hole an even greater reduction in local mean stress occurred, accompanied by some increase in the local stress amplitude; but instead of the expected increase in endurance there was in fact a reduction. A possible explanation is that the prestress loosened the bush which caused an increase in fretting damage.
- (iii) Under narrow band random loading the occasional peak loads maintained a low level of mean stress by inducing compressive residual stresses following local tensile yielding in both bushed and unbushed lugs, whilst having virtually no effect on local stress ranges, and $\sum \frac{n}{N}$ was generally greater than one. When allowance was made for the lowering of the mean stress in the bushed lugs, improved life estimates were produced for fatigue tests at 153 (95) MN/m² mean stress, while worse, unsafe estimates were found for a mean stress of 225 (140) MN/m². It is possible that the large load peaks loosened the bush in this case in a similar manner to the effect of a prestress noted in (ii).

Appendix ALOCAL STRESSES IN A BUSHED LUGA.1 The effect of an interference fit on local stress history in a lug

In the Introduction it was stated that with the introduction of an interference-fit bush there is a reduction in stress amplitude at the point of crack initiation. The reason for this can be explained by imagining the bush as a stiff spring in compression inside the hole in the lug, as shown in Fig 39. The spring produces a tensile stress and strain in the lug material surrounding the hole. The load transmitted by the pin is modelled by the load at point A, which is at the top of the spring, where it contacts the lug bore. On application of a tensile load at this point, the material surrounding the hole will experience a tensile strain, which will allow the spring to extend and thus relieve some of its compression. As a consequence the tensile stress in the lug due to the spring is decreased. Thus, referring to Fig 40, the lug material will experience an increase in tensile stress due to the external load and a reduction in the tensile stress due to the spring. The net effect is that the local stress amplitude under external loading is reduced by the presence of the interference fit. However, the hoop stress created by the interference will cause an increase in local mean stress, but this has usually been assumed to be of only minor importance when compared to the reduction in stress amplitude.

A.2 The effect of a prestress on local stress range in a bushed hole

In section 4.3 during the analysis of local stress measurements investigating the effect of prestress it was observed that the local stress range in the bushed lug was increased during subsequent constant amplitude loading. A simple explanation of the increase in stress range after the application of a prestress can be made by referring once again to Fig 39, where the spring represents the bush. If a sufficiently large load is applied at point A such that local yielding takes place, then the hole in which the spring is held will be permanently deformed. Thus the compression in the spring will be reduced, which means that the stress range over which the spring can help reduce local stress is reduced, as it can only work in compression.

Appendix BFATIGUE TESTING FACILITY AND LOAD SPECTRA

The tests were all carried out on a modified Schenck resonant fatigue machine operating at 27.4 Hz. Either constant amplitude or narrow band random loading could be applied, control being achieved in a similar manner to that described by Edwards¹⁰. The original out-of-balance mass exciter was replaced by an electrohydraulic exciter in the case of the unbushed lugs. The bushed specimens were tested at a later point in time when an electromagnetic exciter replaced the electrohydraulic one.

The spectrum shape was measured at all stress levels used by means of a levels-crossed counter¹¹. All spectrum measurements were made when the electromagnetic exciter was in use, including those for the unbushed lugs. It was considered that the type of exciter would make no difference to the response of the machine and hence the spectrum shape. The levels-crossed counter measured the cumulative number of times the stress exceeded a series of amplitude levels (exceedings), equally spaced over the range of the spectrum. In this report the results of these measurements are plotted in the form cumulative number of exceedings on a logarithmic scale against the non-dimensional quantity

$$\frac{\text{amplitude level}}{\text{root mean square value of waveform}} \cdot$$

Plotted in this way true Gaussian narrow band random loading would produce a straight line. In practice there is a truncation of the higher levels of load due to mechanical damping, as can be seen in Figs 41 and 42.

Appendix C

CUMULATIVE DAMAGE CALCULATIONS MADE USING MINER'S RULE¹²

Miner's Rule states that if a component is subjected to a variable amplitude loading sequence containing stress amplitudes σ_q ($q = 1, 2, 3 \dots p$), then the fraction of the total life used up by any single stress cycle at stress amplitude σ_q is given by $1/N_q$ where N_q is the expected number of cycles to failure of the component under stress amplitude σ_q alone.

Therefore the total fraction of the fatigue life used up by the variable amplitude waveform is

$$\sum_{q=1}^{q=p} \frac{n_q}{N_q}$$

where n_q is the number of cycles of stress amplitude σ_q contained in the variable amplitude waveform.

The rule predicts failure when

$$\sum_{q=1}^{q=p} \frac{n_q}{N_q} = 1$$

The accuracy of the rule is generally judged by computing the ratio

$$\sum_{q=0}^{q=p} \frac{n_q}{N_q} : 1$$

for specimens which have been tested to failure. Since the rule predicts failure when $\sum \frac{n_q}{N_q} = 1$, the computed value of the ratio at failure is equal to the ratio $\frac{\text{achieved life}}{\text{predicted life}}$.

When carrying out the predictions in this report the actual measured load spectrum for the particular condition and stress level was used in all cases.

It was necessary in carrying out the predictions to use S-N curves which extended above the stresses actually tested. This was done by extrapolating to the static failure point.

Appendix DMETHOD OF LIFE ESTIMATION ALLOWING FOR RESIDUAL STRESSES

Section 4.2 described the construction of Figs 26 and 27 which present the local stress histories in bushed and unbushed lugs under constant amplitude loading. This, in combination with the relevant S-N curves enabled the local mean-local alternating stress diagram of Fig 43 to be drawn for bushed lugs. It was decided to construct the diagram for the case of passivated bushes, since this is likely to be the situation met in practice. Fatigue results were available at only the low mean stress for passivated bushes but at both low and high mean stress for non-passivated bushes. However it was found, in section 4.1 that at the lower mean stress passivation had little effect except at long lives where it reduced the fatigue strength. As the higher mean stress reduced the fatigue strength at long lives to a very low value, see Fig 11, passivation could have had very little further effect and thus it was assumed that the S-N curves for both passivated and unpassivated bushes at the higher mean stress were identical. It will be noted that a Goodman-type straight line relationship was assumed on the mean-alternating stress diagram.

Having plotted the mean-alternating stress diagram new S-N curves could be constructed at any new local mean stress. The local mean stresses for the random spectra tested were obtained from the local stress measurements, see Figs 29-33, and new S-N curves were constructed for each random spectra case, which were used with the appropriate spectrum measurement to calculate the fatigue life allowing for residual stresses.

Table 1CHEMICAL COMPOSITION AND TENSILE PROPERTIES OF BS 2L65 ALUMINIUM ALLOY

Chemical composition (nominal)% w/w	4.4 Cu, 0.7 Mg, 0.7 Si, 0.6 Mn, balance Al	
Tensile properties (measured)	UTS	- 517 MN/m ²
	0.1% proof	- 462 MN/m ²
	Elongation	- 10%

Table 2FATIGUE TEST RESULTS

CONSTANT AMPLITUDE LOADING

Mean pin bearing stress = 153 MN/m^2 (Mean net stress* = 95 MN/m^2)

Bushes unpassivated

Specimen No.	Rms pin bearing stress (MN/m^2)	*Rms net stress (MN/m^2)	Life (10^4 cycles)	Log mean life (10^4 cycles)
825	32.2	20	128.0	
430	32.2	20	289.0	
744	32.2	20	78.5	
438	32.2	20	1610.0 (UB)	
439	36.2	22.5	147.0	
440	36.2	22.5	96.0	134
749	36.2	22.5	328.0	
502	36.2	22.5	69.1	
379	40.3	25	122	
426	40.3	25	63.7	77.0
432	40.3	25	58.8	
375	48.3	30	38.2	
378	48.3	30	123.0	71.3
381	48.3	30	82.6	
385	48.3	30	67.0	
370	64.4	40	21.8	
373	64.4	40	26.3	23.5
377	64.4	40	21.8	
448	64.4	40	24.3	
369	80.5	50	7.8	
371	80.5	50	19.1	
376	80.5	50	11.9	9.9
384	80.5	50	7.2	
433	80.5	50	7.4	

(UB) Unbroken

* Based on net section area including bush wall

Table 3

FATIGUE TEST RESULTS

CONSTANT AMPLITUDE LOADING

Mean pin bearing stress = 153 MN/m^2 (Mean net stress* = 95 MN/m^2)

Bushes passivated

Specimen No.	Rms pin bearing stress (MN/m ²)	*Rms net stress (MN/m ²)	Life (10 ⁴ cycles)	Log mean life (10 ⁴ cycles)
481	16.1	10	1020 (UB)	
763	24.2	15	309.0	267
458	24.2	15	417.0	
467	24.2	15	149.0	
486	32.2	20	66.0	
380	32.2	20	119.0	101.0
372	32.2	20	131.0	
504	48.3	30	54.2	
832	48.3	30	38.0	46.8
427	48.3	30	49.7	
390	64.4	40	15.8	
306	64.4	40	24.6	17.6
474	64.4	40	23.1	
462	64.4	40	10.7	
835	80.5	50	7.9	
383	80.5	50	7.6	7.3
475	80.5	50	6.4	

(UB) Unbroken

* Based on net section area including bush wall

Table 4

FATIGUE TEST RESULTS

CONSTANT AMPLITUDE LOADING

Mean pin bearing stress = 225 MN/m²(Mean net stress* = 140 MN/m²)

Bushes unpassivated

Specimen No.	Rms pin bearing stress (MN/m ²)	*Rms net stress (MN/m ²)	Life (10 ⁴ cycles)	Log mean life (10 ⁴ cycles)
746	8.05	5	441.0	505
457	8.05	5	578.0	
743	8.05	5	389.0	
450	8.05	5	657.0	
653	16.1	10	113.0	77.1
472	16.1	10	81.6	
838	16.1	10	38.2	
745	16.1	10	101.0	
499	24.2	15	50.1	32.5
686	32.2	20	26.7	
451	32.2	20	39.1	
654	32.2	20	72.8	
489	32.2	20	14.8	13.3
839	48.3	30	8.6	
750	48.3	30	19.8	
503	48.3	30	18.1	
488	48.3	30	10.3	7.2
685	64.4	40	6.4	
482	64.4	40	8.0	
761	64.4	40	7.8	
495	64.4	40	6.6	

* Based on net section area including bush wall

Table 5

FATIGUE TEST RESULTS

CONSTANT AMPLITUDE LOADING WITH A PRESTRESS

Mean pin bearing stress = 153 MN/m^2 . Pin bearing prestress = 402 MN/m^2
 (Mean net stress* = 95 MN/m^2 .) (Net prestress = 250 MN/m^2 .)

Bushes unpassivated

Specimen No.	Rms pin bearing stress (MN/m^2)	*Rms net stress (MN/m^2)	Life (10^4 cycles)	Log mean life (10^4 cycles)
478	64.4	40	17.7	16.7
756	64.4	40	19.7	
505	64.4	40	13.6	
455	64.4	40	16.4	

Table 6

FATIGUE TEST RESULTS

CONSTANT AMPLITUDE LOADING WITH A PRESTRESS

Mean pin bearing stress = 153 MN/m^2 . Pin bearing prestress = 474 MN/m^2
 (Mean net stress* = 95 MN/m^2 .) (Net prestress = 294 MN/m^2 .)

Bushes unpassivated

Specimen No.	Rms pin bearing stress (MN/m^2)	*Rms net stress (MN/m^2)	Life (10^4 cycles)	Log mean life (10^4 cycles)
468	64.4	40	10.1	10.4
830	64.4	40	11.5	
754	64.4	40	10.3	
827	64.4	40	9.7	

* Based on net section area including bush wall

Table 7FATIGUE TEST RESULTS

NARROW BAND RANDOM LOADING

Mean pin bearing stress = 153 MN/m^2 (Mean net stress* = 95 MN/m^2)

Bushes unpassivated

Specimen No.	Rms pin bearing stress (MN/m^2)	*Rms net stress (MN/m^2)	Life (10^4 cycles)	Log mean life (10^4 cycles)
484	32.2	20	118.0	152.0
454	32.2	20	192.0	
477	32.2	20	156.0	

Table 8FATIGUE TEST RESULTS

NARROW BAND RANDOM LOADING

Mean pin bearing stress = 153 MN/m^2)(Mean net stress* = 95 MN/m^2)

Bushes passivated

Specimen No.	Rms pin bearing stress (MN/m^2)	*Rms net stress (MN/m^2)	Life (10^4 cycles)	Log mean life (10^4 cycles)
453	32.2	20	258.0	197
452	32.2	20	189.0	
461	32.2	20	156.0	
500	45.9	28.5	165.0	125
460	45.9	28.5	104.0	
748	45.9	28.5	113.0	

* Based on net section area including bush wall

Table 9

FATIGUE TEST RESULTS

NARROW BAND RANDOM LOADING

Mean stress = 225 MN/m^2 (Mean net stress* = 140 MN/m^2)

Bushes unpassivated

Specimen No.	Rms pin bearing stress (MN/m^2)	*Rms net stress (MN/m^2)	Life (10^4 cycles)	Log mean life (10^4 cycles)	
470	16.1	10	149.0	56.5	
485	16.1	10	448.0		
464	16.1	10	1660.0 (UB)		
463	16.1	10	319.0		
473	32.2	20	66.2		
490	32.2	20	46.2		
493	32.2	20	42.5		
494	32.2	20	78.2		
711	48.3	30	28.4		26.1
491	48.3	30	21.9		
487	48.3	30	36.5		
466	48.3	30	20.4		
483	64.4	40	10.4	13.0	
826	64.4	40	12.6		
492	64.4	40	15.7		
459	64.4	40	14.1		

(UB) Unbroken

* Based on net section area including bush wall

REFERENCES

<u>No</u>	<u>Author</u>	<u>Title, etc</u>
1	W.A.P. Fisher W.J. Winkworth	Improvement in the fatigue strength of joints by the use of interference fits. ARC R & M No.2874 (1952)
2	O. Gokgöl	Estimation of endurance of light metal alloy lugs with interference fit bushes. RAE Library Translation 1861 (1975)
3	W.A.P. Fisher H. Yeomans	Further fatigue tests on loaded holes with interference fit bushes. RAE Technical Note Structures 210, ARC 19462 (1956)
4	D.J. White	The fatigue strength of large single pinned and double pinned connections made from alloy steel FW 520B. I. Mech. E. Applied Mechanics Group Proceedings 1968-1969, Volume 183 Part 1
5	P.R. Edwards R.J. Ryman	Studies in fretting fatigue under variable amplitude loading conditions. RAE Technical Report 75132, ARC 36737 (1975)
6	C.R. Smith	Linear strain theory and the Smith Method for predicting fatigue life of structures for spectrum type loading. ARL Report 64-55, April 1964
7	J.H. Crews Jr H.F. Hardrath	A study of cyclic plastic stresses at a notch root. Exp. Mechanics 23, pp 313-320 (1966)
8	J.E. Moon P.R. Edwards	Fatigue behaviour of pin-loaded lugs in BS 2L65 aluminium alloy. ARC R & M No.3834 (1977)
9		Cumulative fatigue damage calculations (effect of correcting mean stress at stress concentrations). Data sheets on fatigue No 71028. Engineering Science Data Unit. Royal Aeronautical Society (1971)

REFERENCES (Concluded)

<u>No</u>	<u>Author</u>	<u>Title, etc</u>
10	P.R. Edwards	A controller for random and constant amplitude loading on resonant and electrohydraulic fatigue machines. RAE Technical Report 72226, ARC 34525 (1973)
11	E.M. Power	The analysis of random data for fatigue testing. Paper presented at the SEE symposium "Statistical Aspects of Fatigue Testing" held at Warwick University 12 February 1975
12	M.A. Miner	Cumulative damage in fatigue. J. Applied Mechanics, Vol 12, No 3, pp A159-A164 (1945)

Scale $\frac{3}{4}$

Nominal dimensions in mm

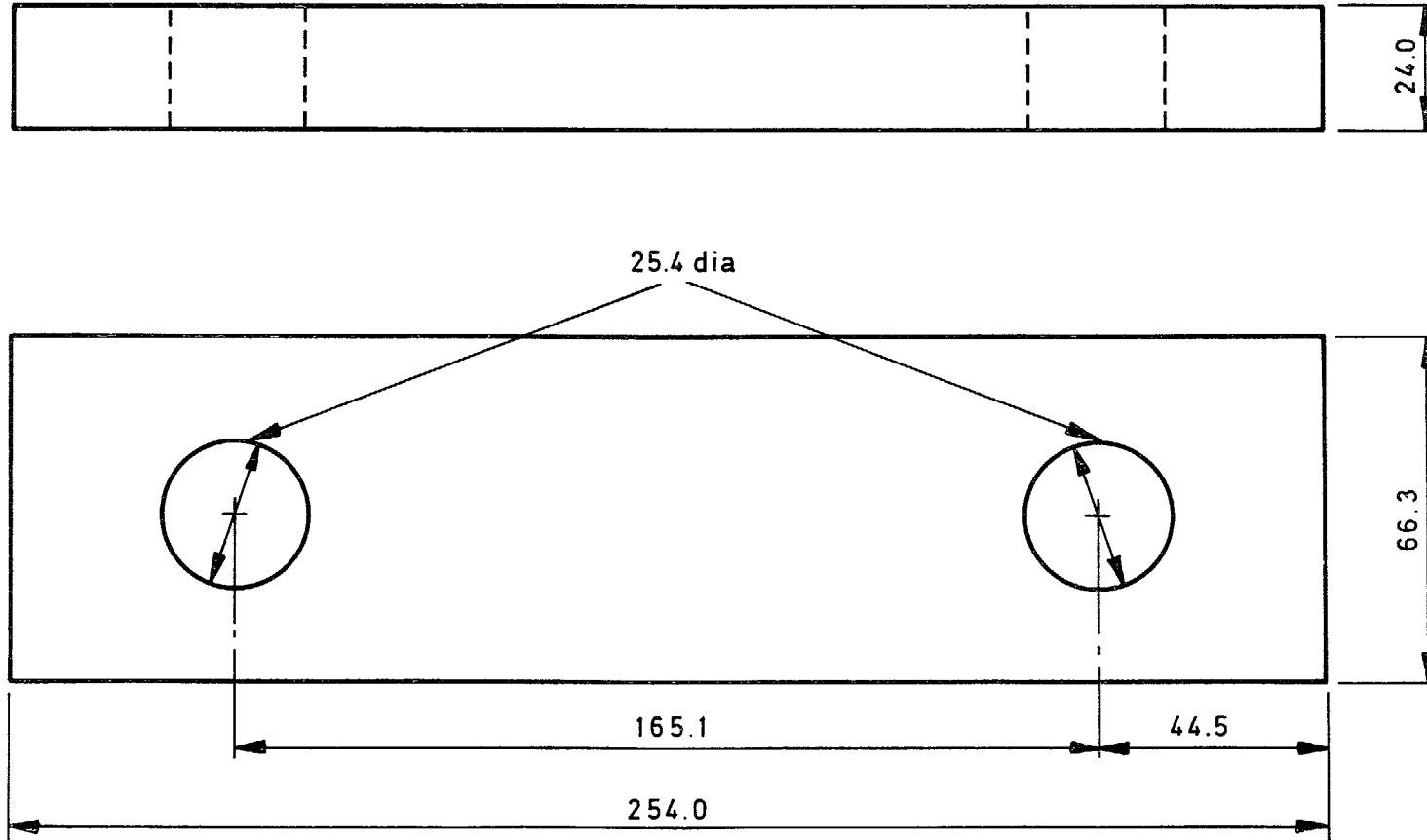

Fig 1 Unbushed lug

Scale $\frac{3}{4}$
Nominal dimensions in mm

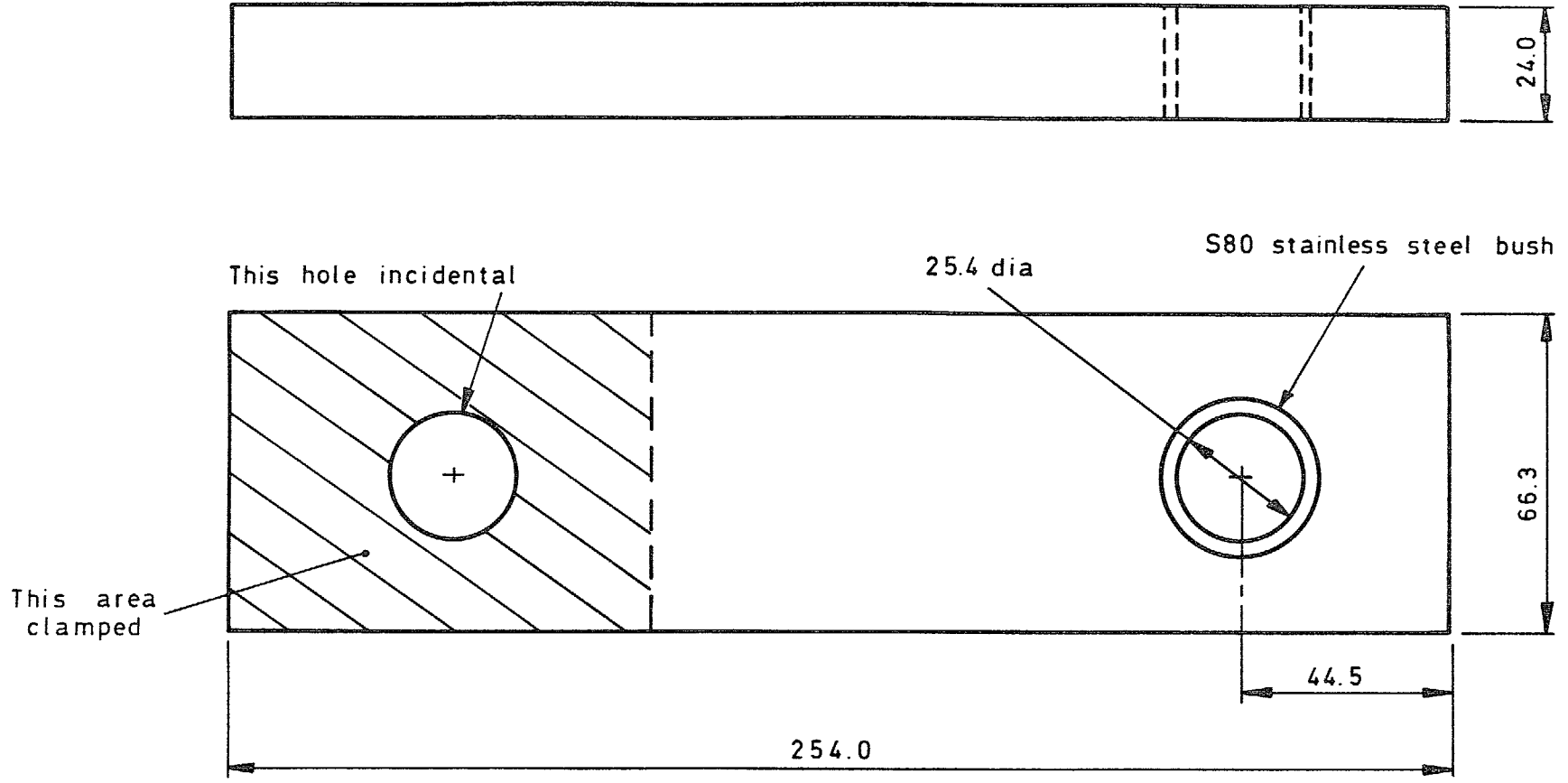
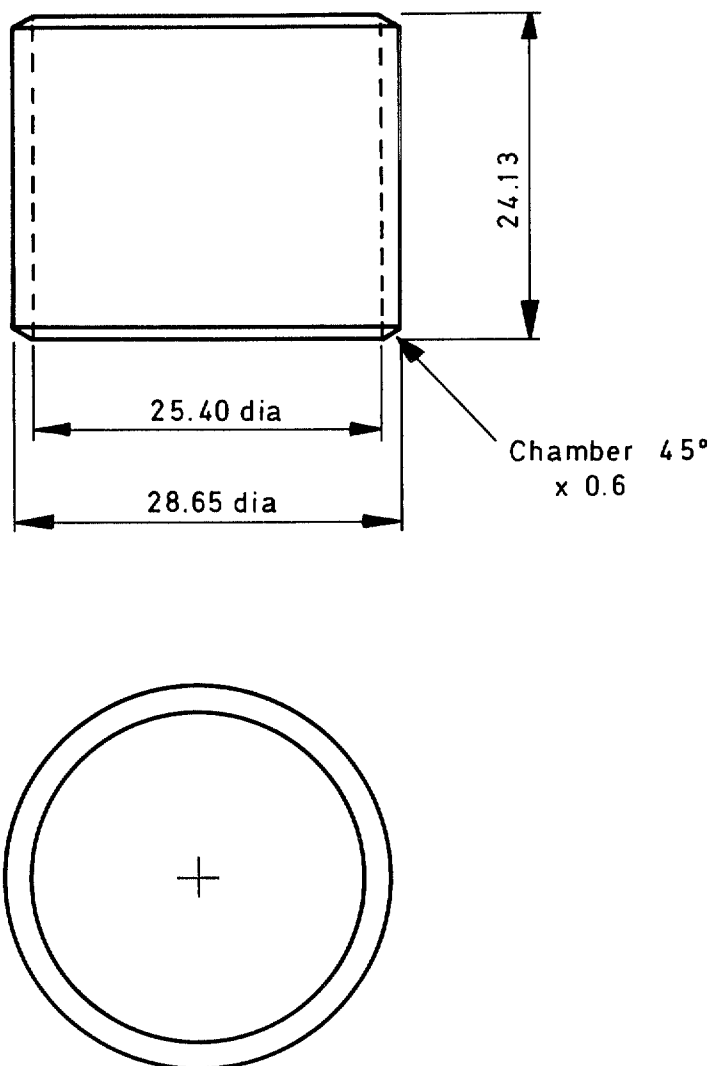

Fig 2 Bushed lug



Scale 2:1
Material S80 steel
Nominal dimensions in mm

Fig 3 Interference fit bush

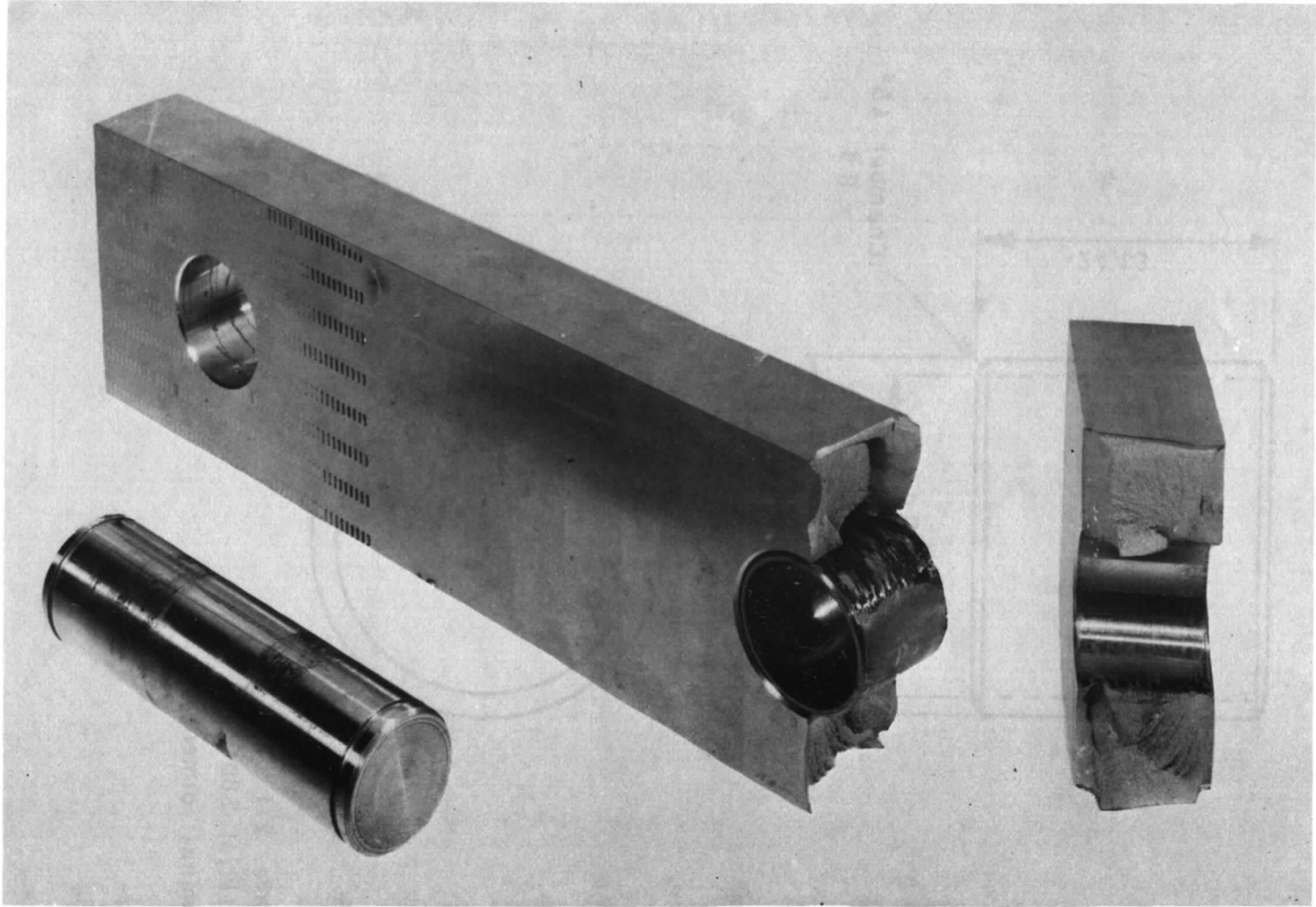

Fig 4 Failed specimen

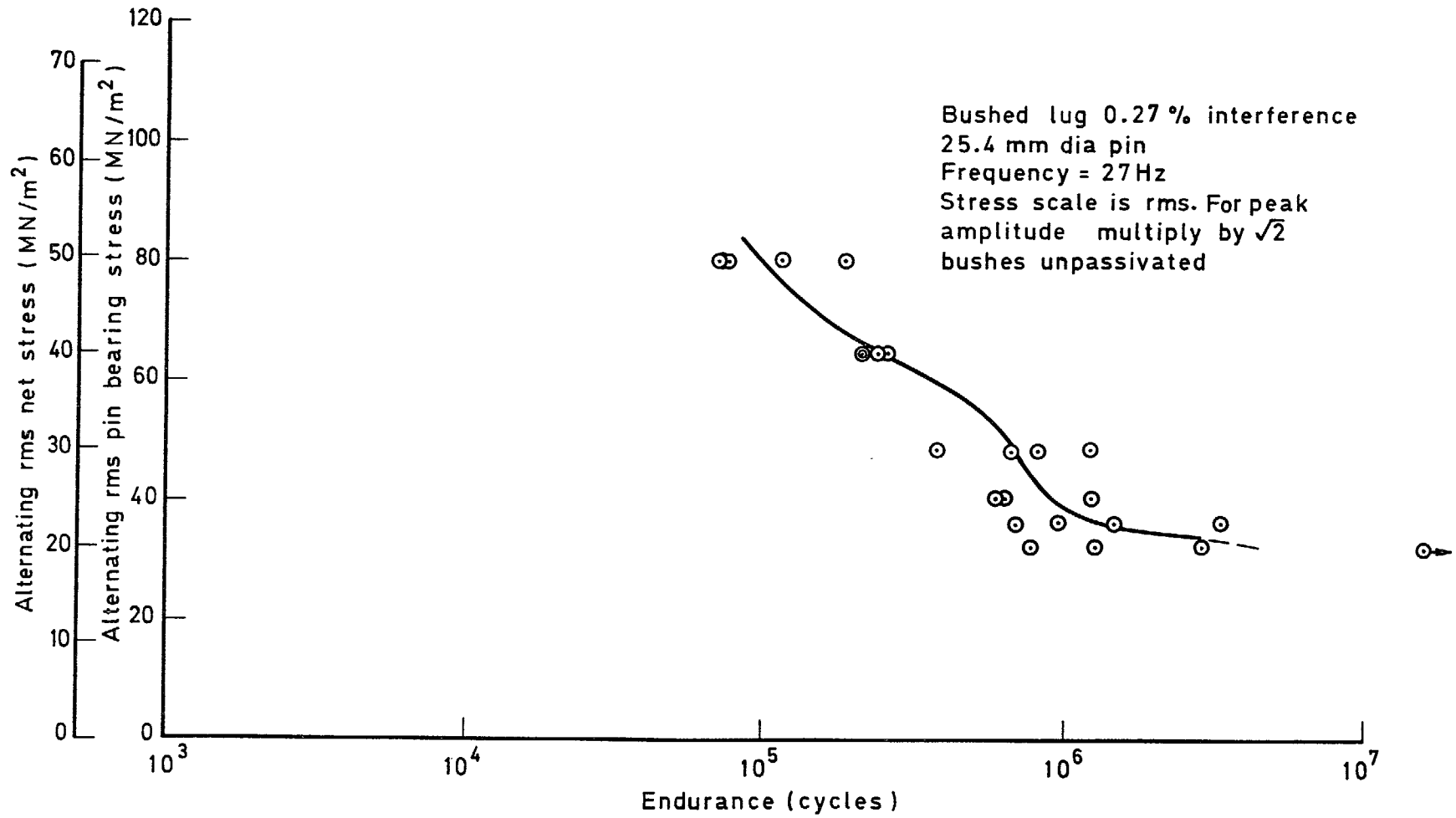

Fig 5 Constant amplitude loading at mean stress = 153(95) MN/m². Bushes unpassivated

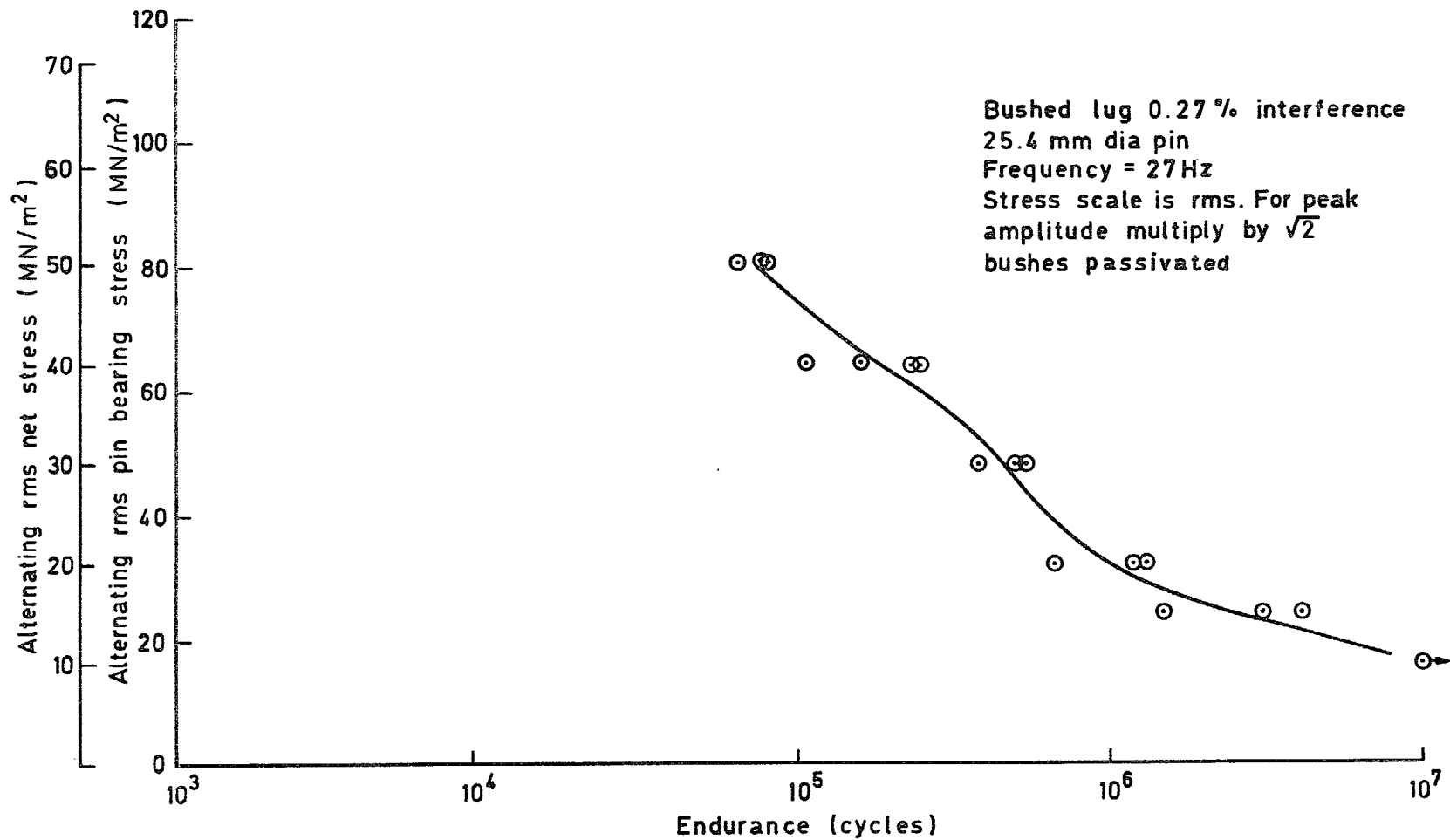

Fig 6 Constant amplitude loading at mean stress = 153(95) MN/m². Bushes passivated

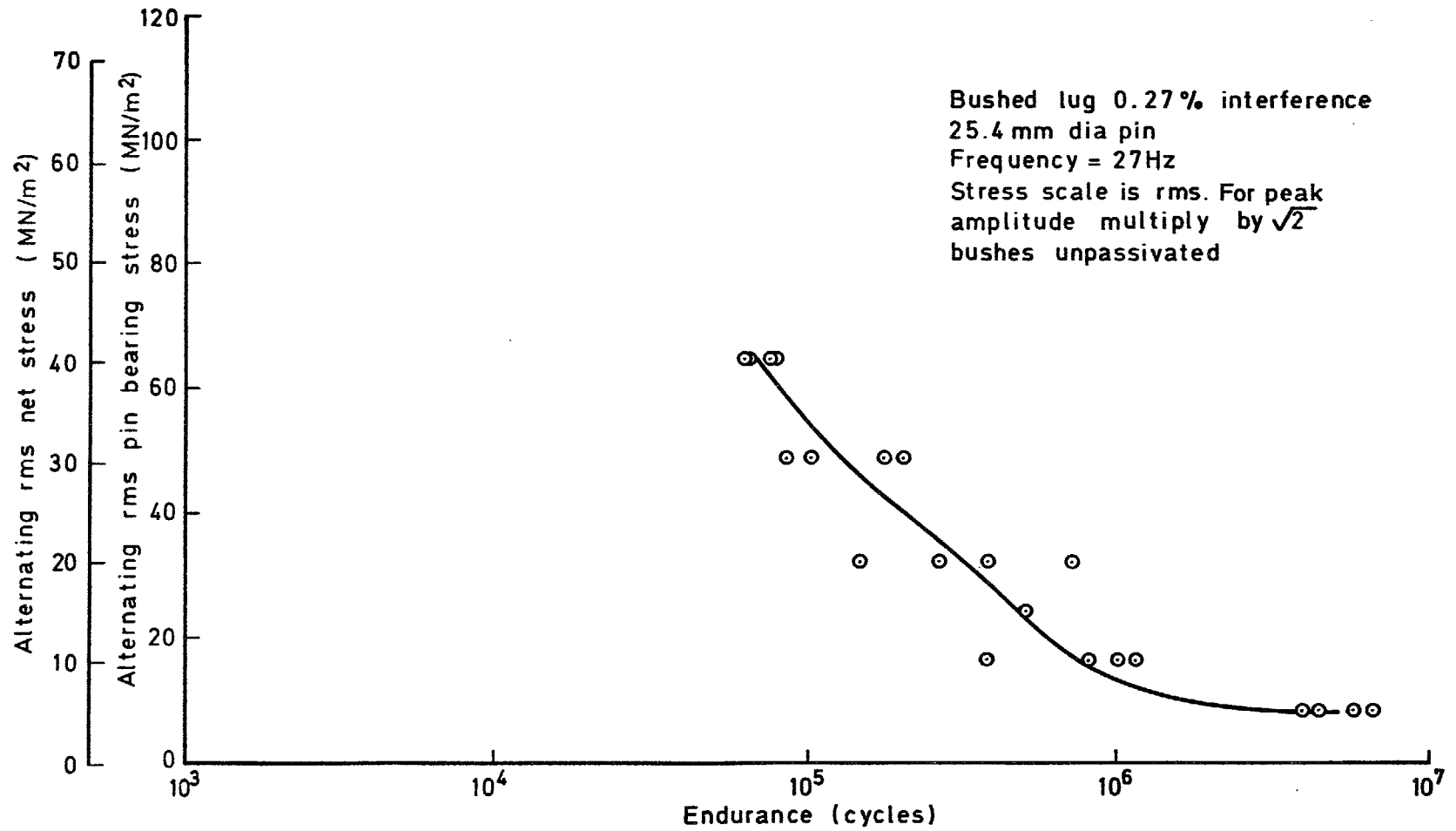

Fig 7 Constant amplitude loading at mean stress = 225(140) MN/m². Bushes unpassivated

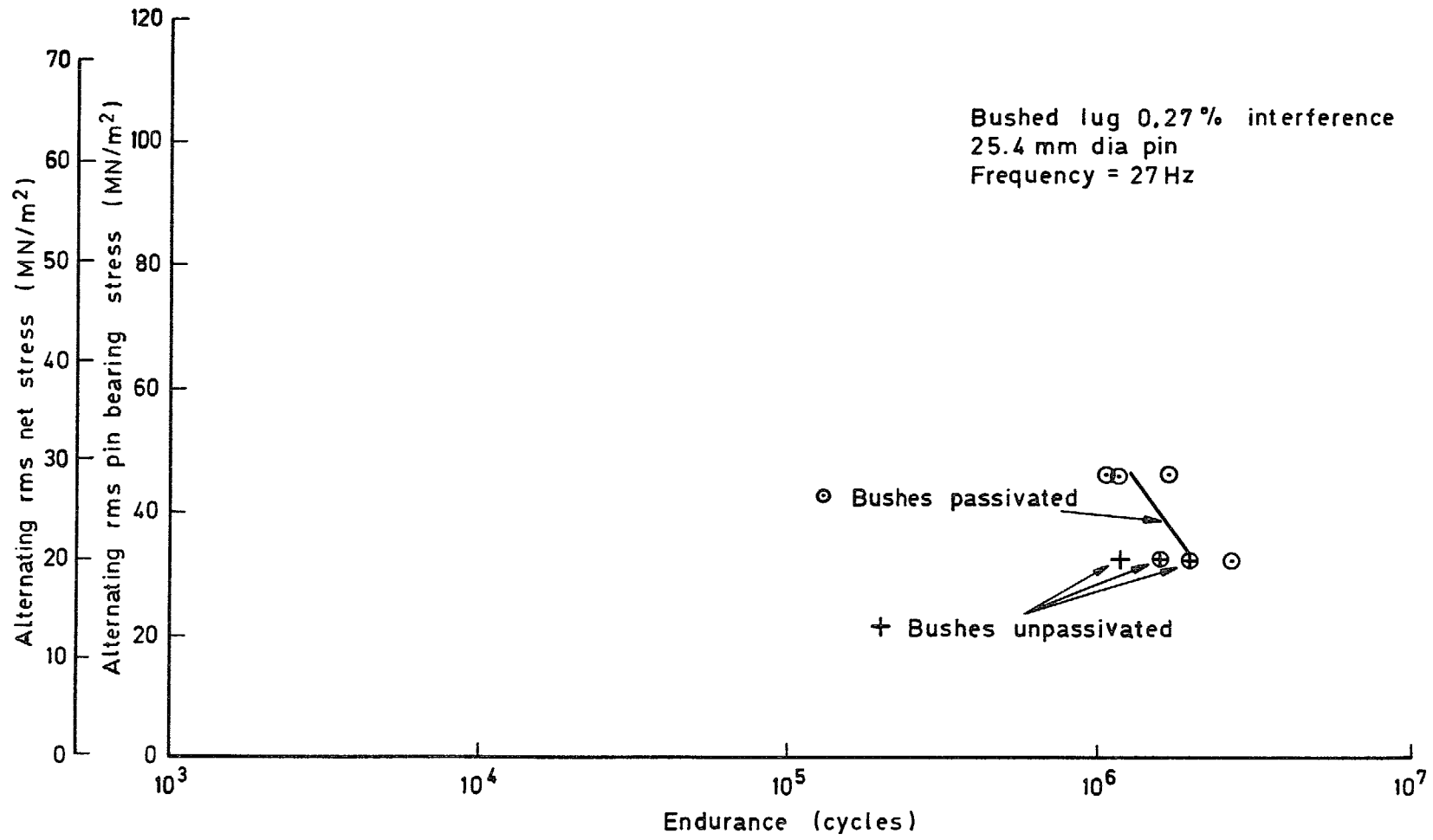

Fig 8 Narrow band random loading at mean stress = 153(95) MN/m²

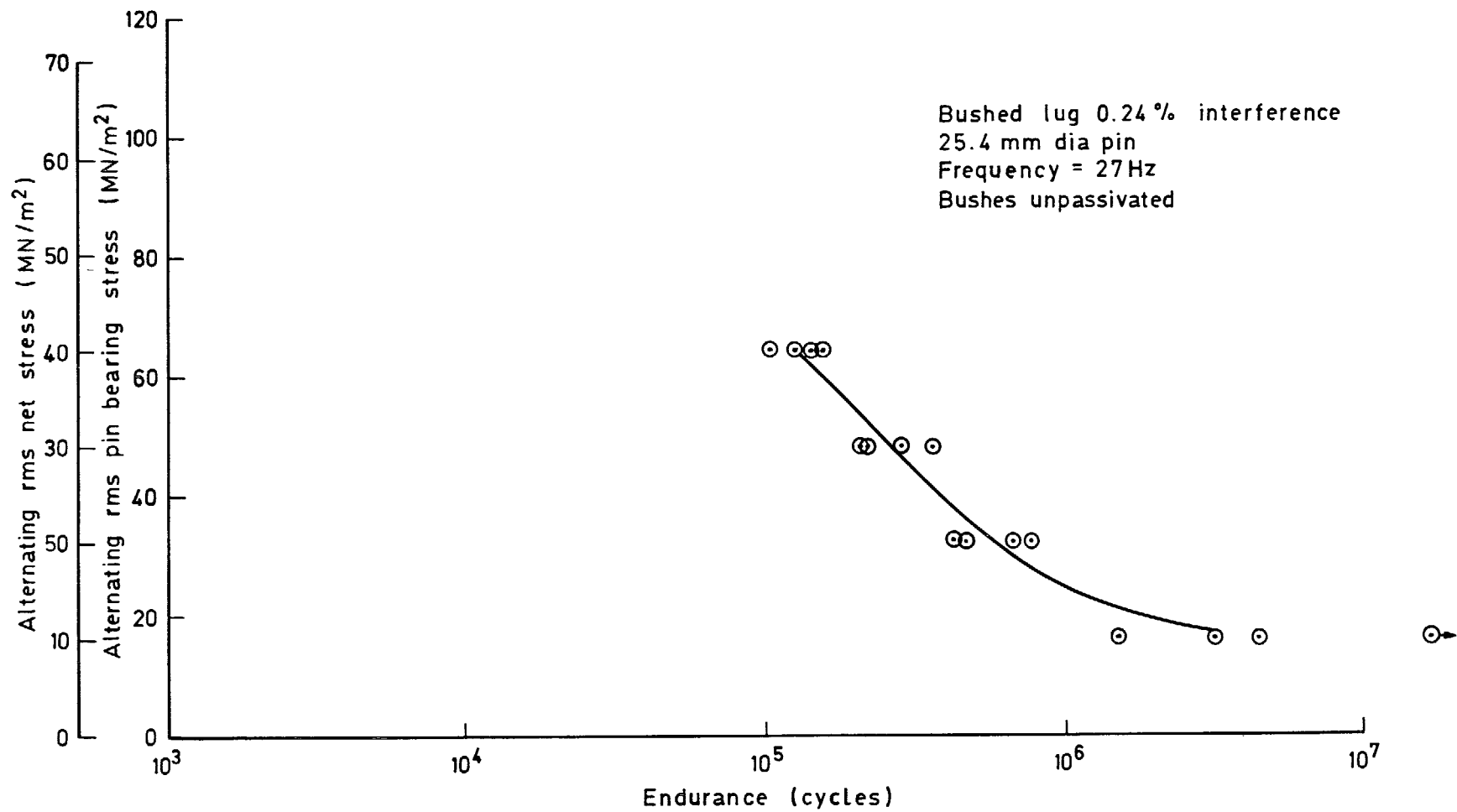

Fig 9 Narrow band random loading at mean stress = 225(140) MN/m². Bushes unpassivated

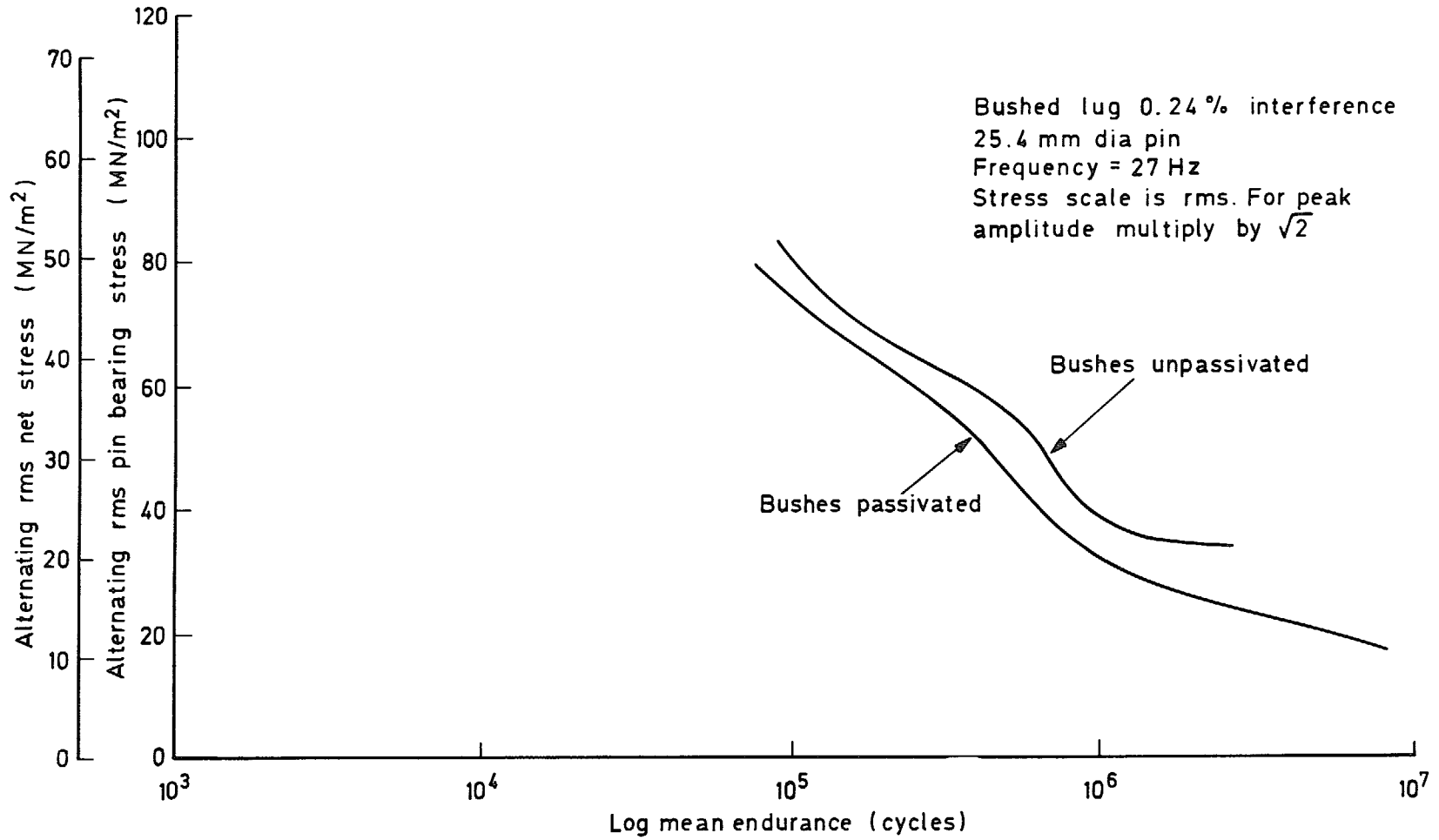

Fig 10 Effect of passivating bushes on constant amplitude performance at mean stress = 153(95) MN/m²

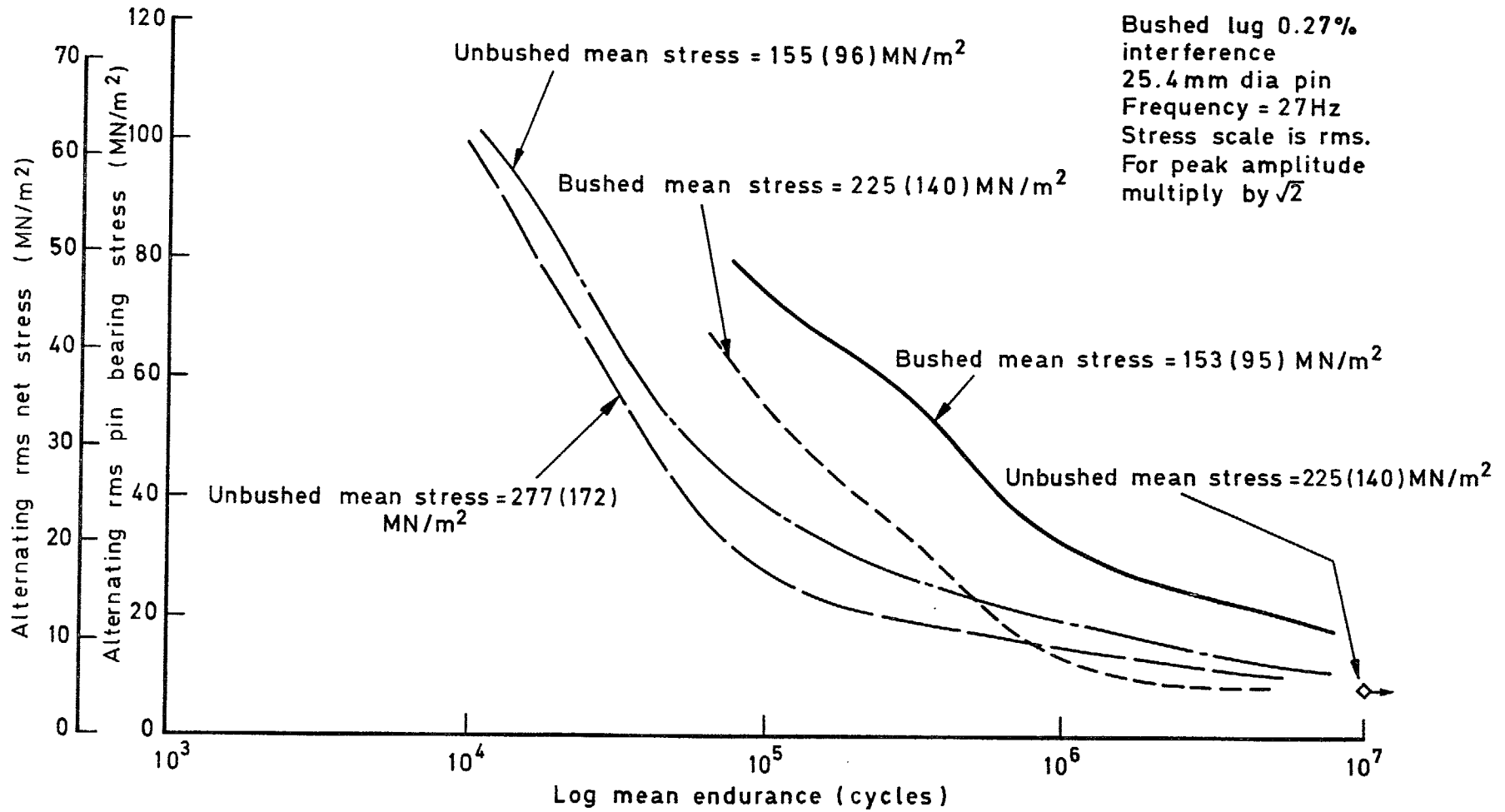

Fig 11 Comparison of the performance of bushed and unbushed lugs under constant amplitude loading

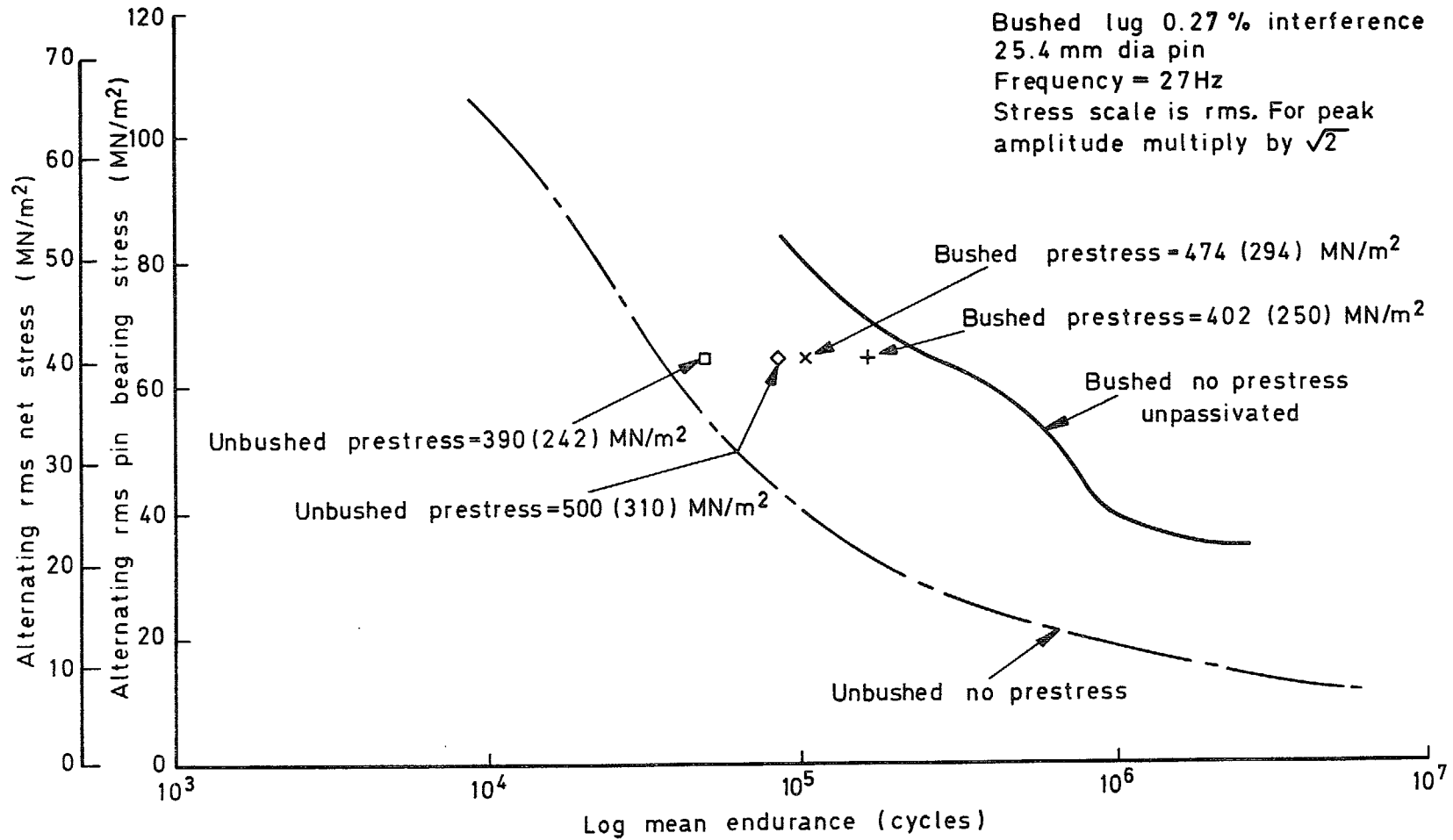

Fig 12 Comparison of the performance of bushed and unshuffled lugs under constant amplitude loading at mean stress = 153(95) MN/m² with and without a prestress

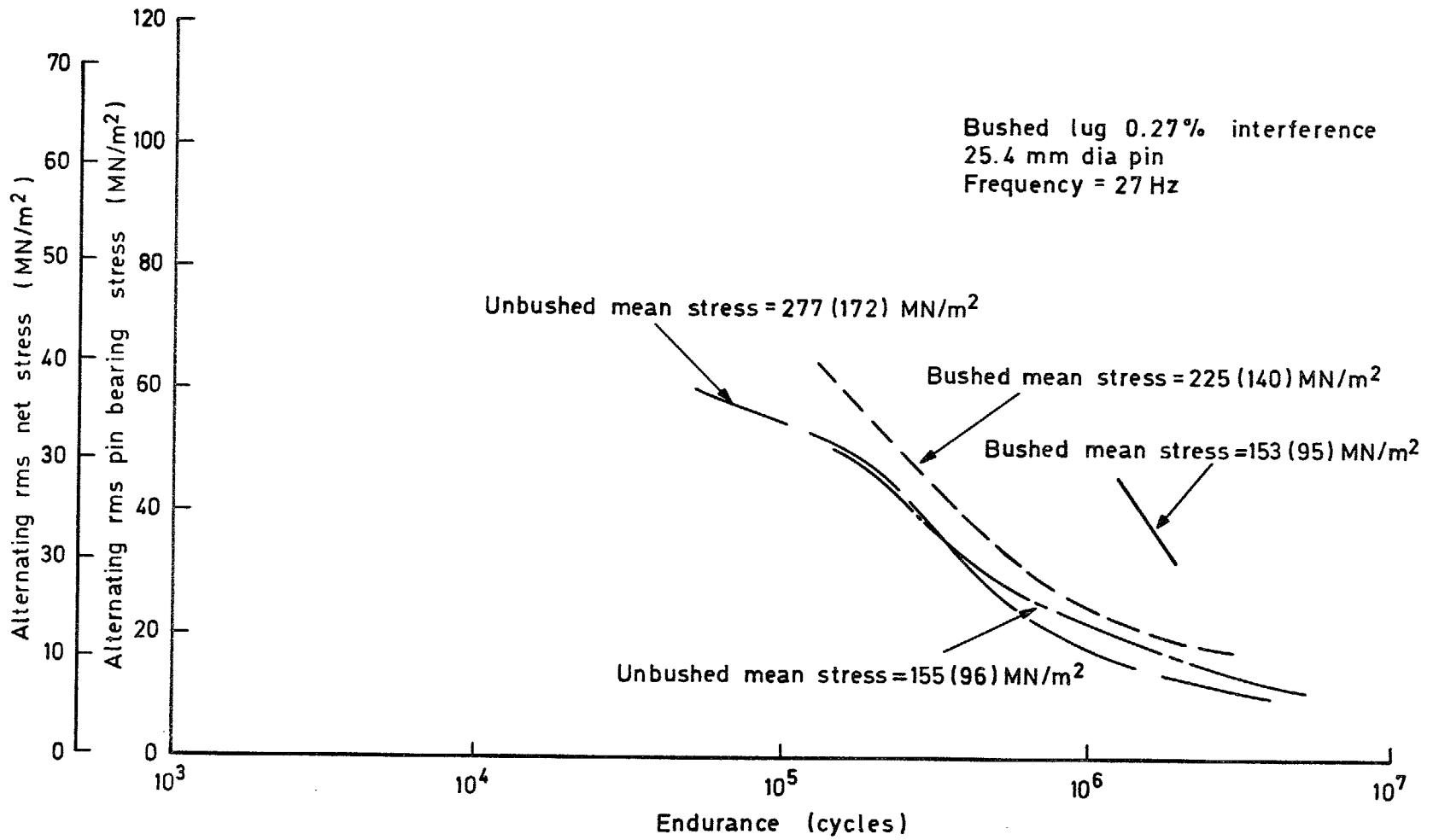

Fig 13 Comparison of the effect of mean stress on bushed and unbushed lugs under NBR loading

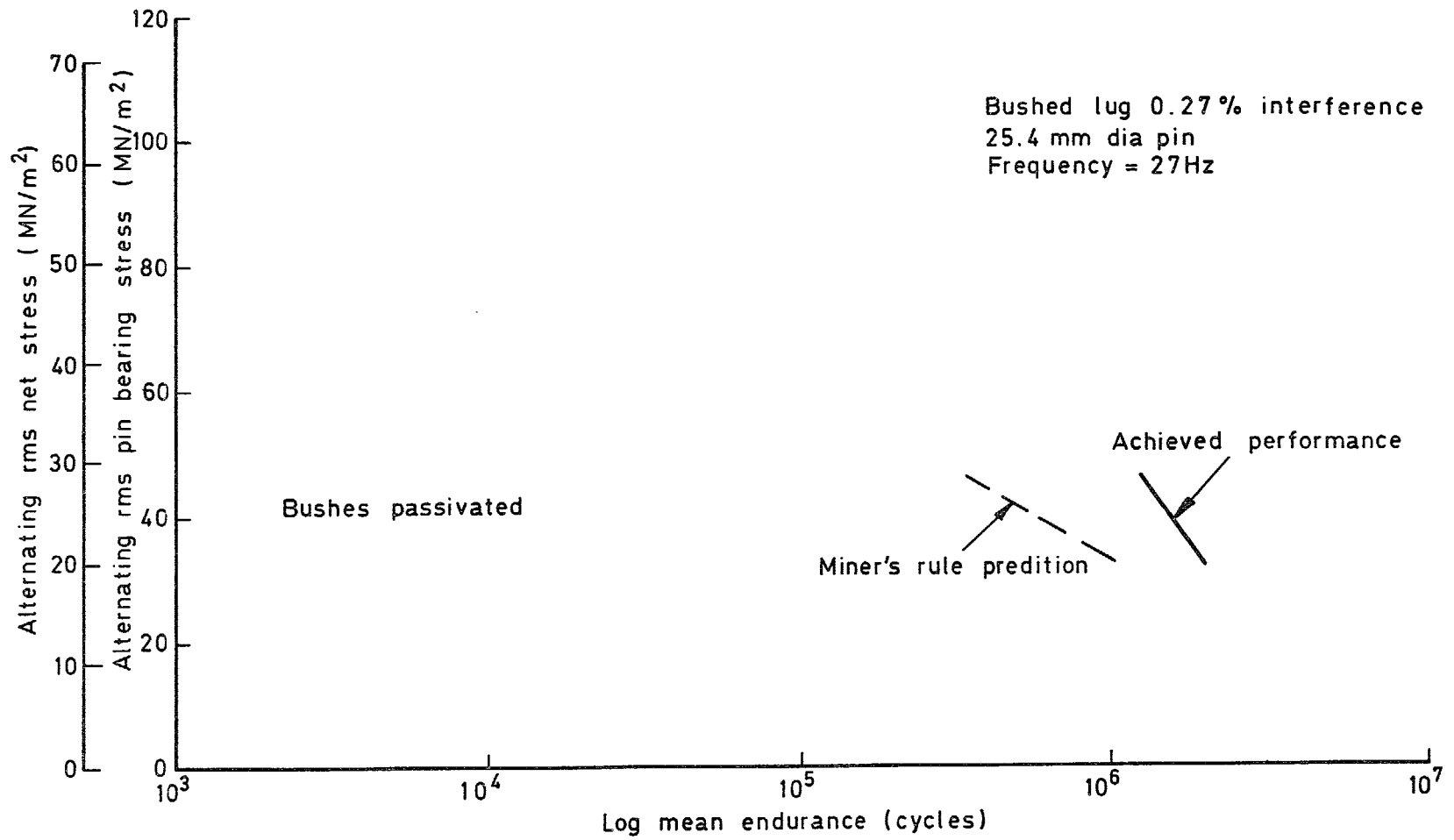

Fig 14 Accuracy of Miner's rule for NBR loading at mean stress = 153(95) MN/m^2

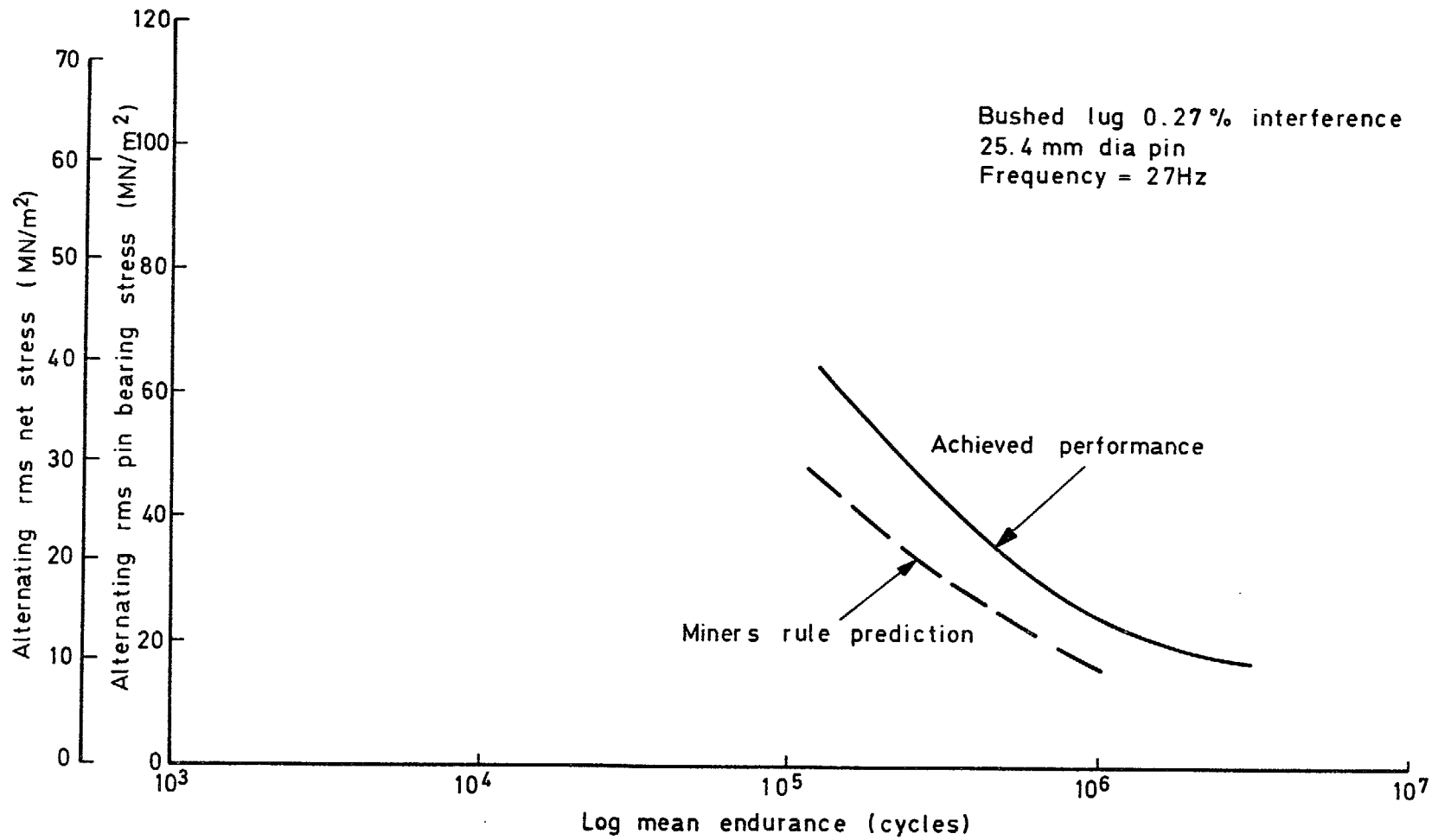

Fig 15 Accuracy of Miner's rule for NBR loading at mean stress = 225(140) MN/m²

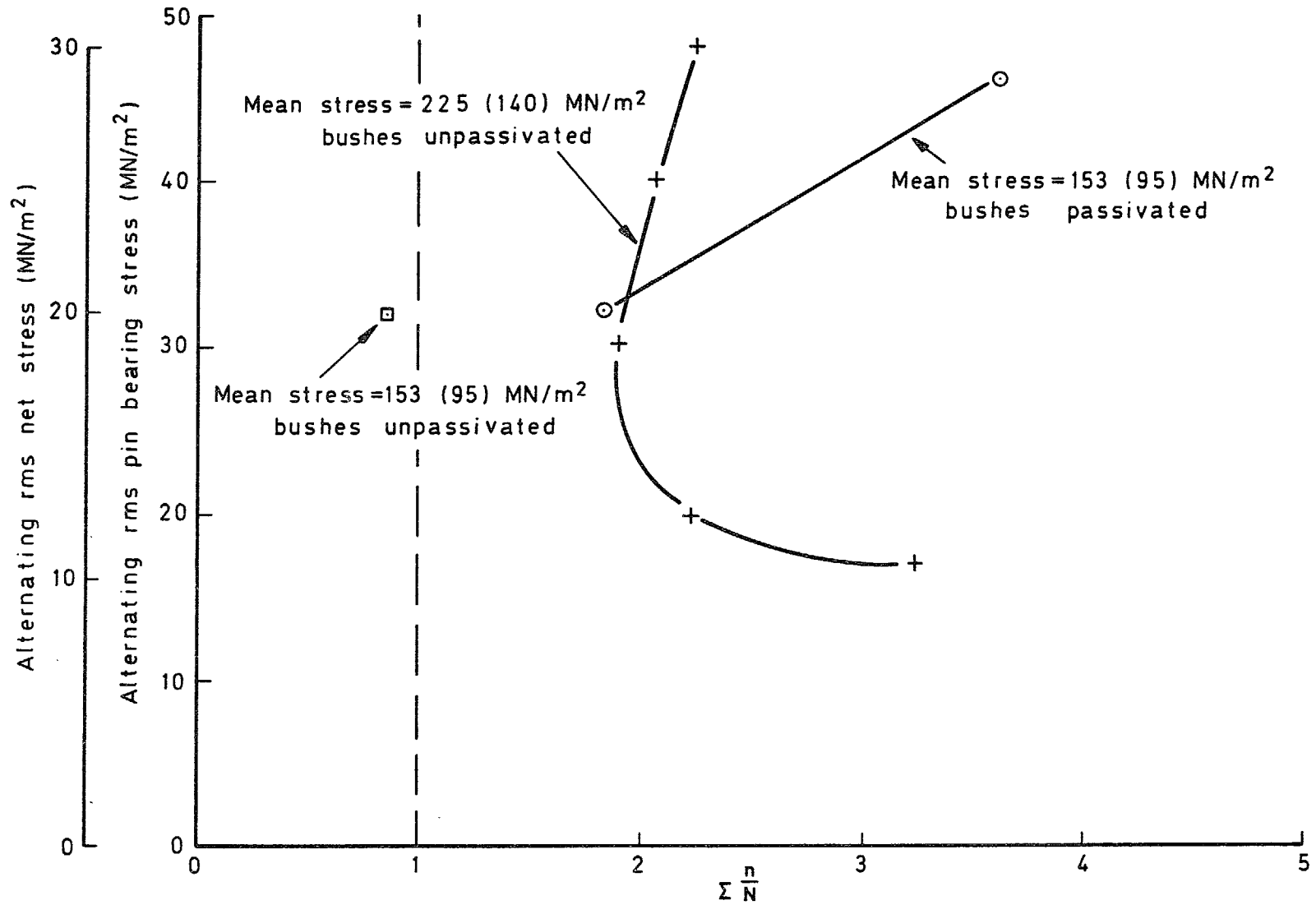

Fig 16 $\sum \frac{n}{N}$ values for lugs with interference fit bushes at two mean stresses under NBR loading

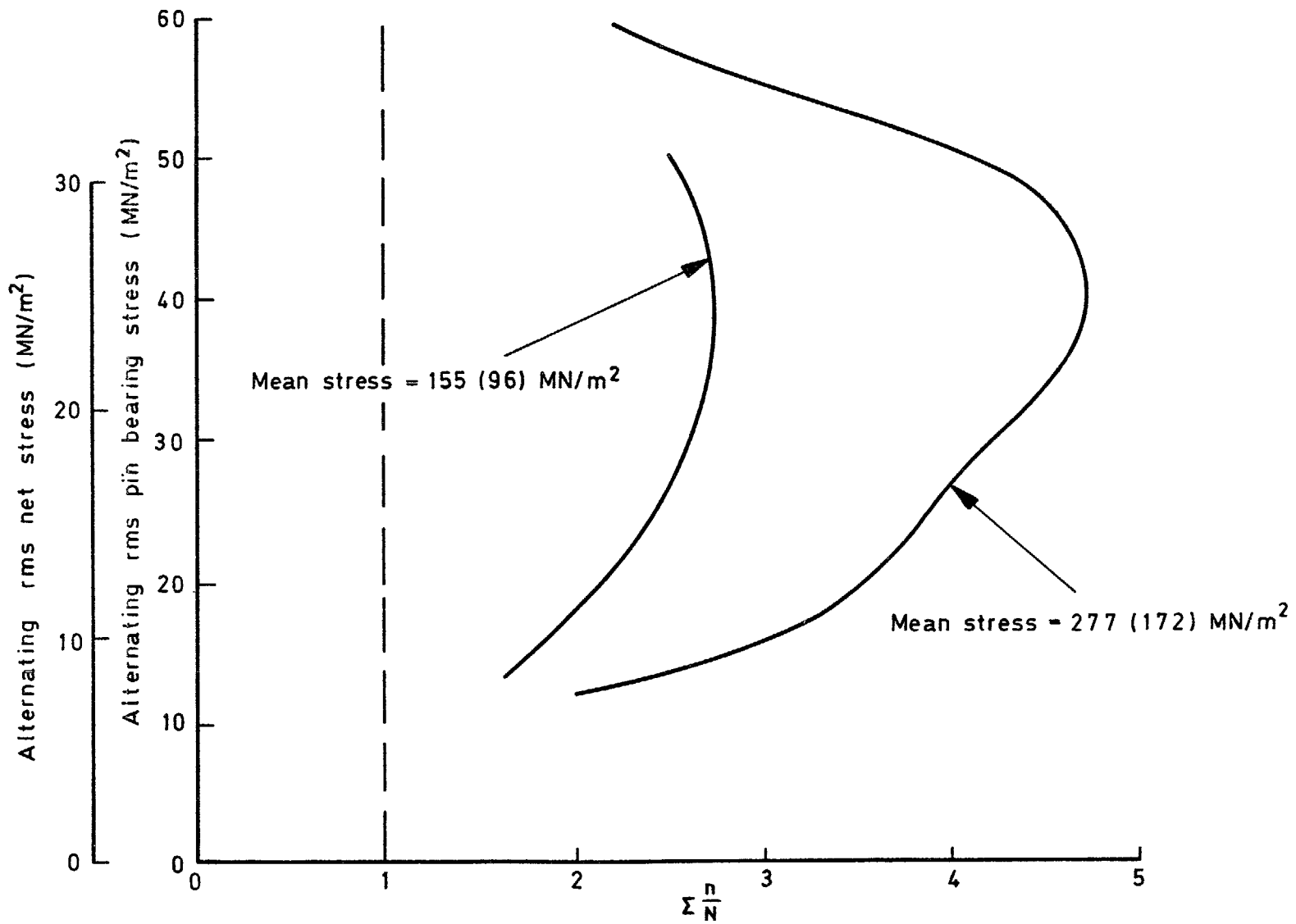

Fig 17 $\Sigma \frac{n}{N}$ values for unbushed lugs at two mean stresses under NBR loading

Material: BS2L65
Nominal dimensions in mm

Hole A - to accommodate bush
Hole B - for clearance fit pin

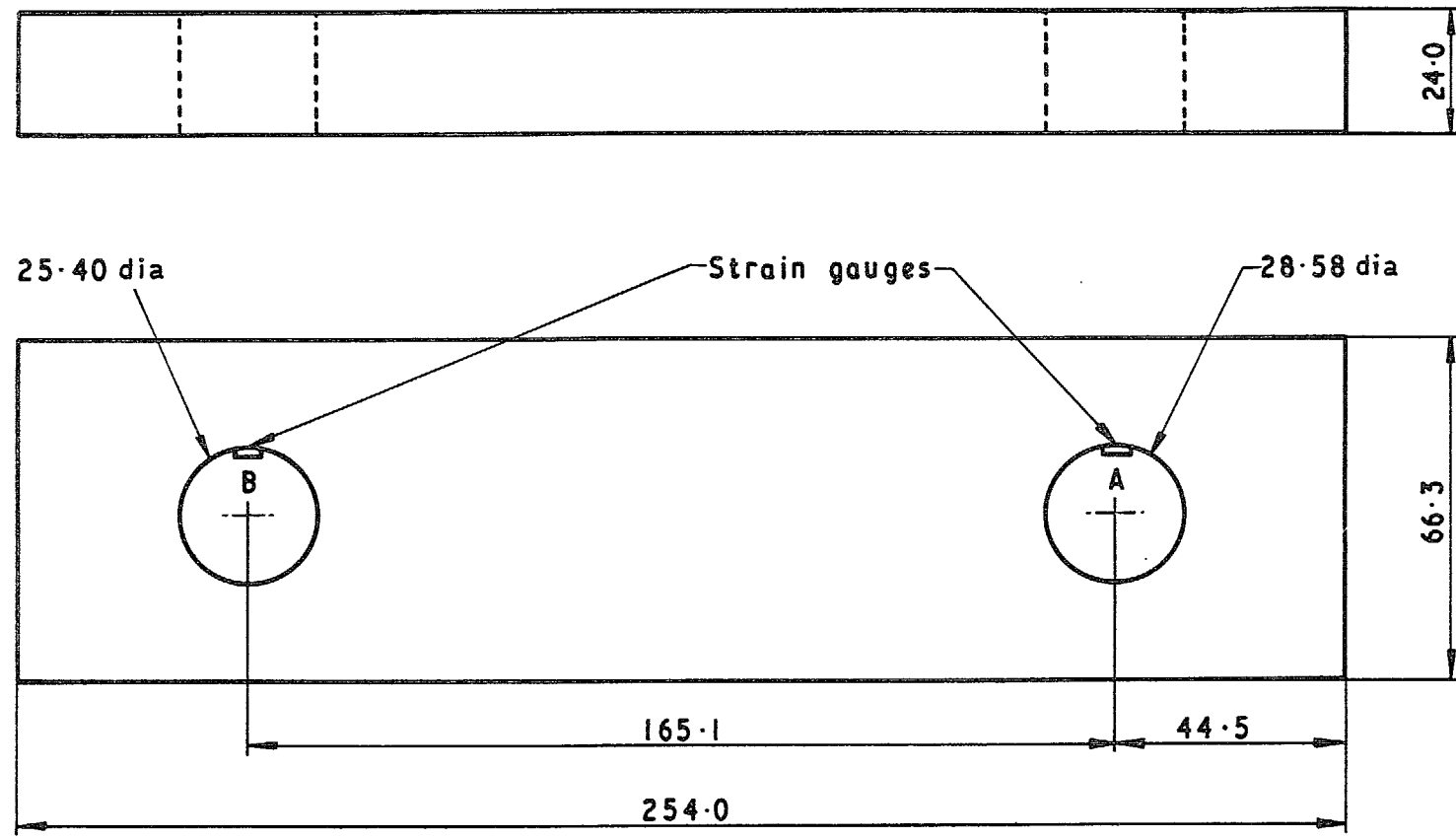
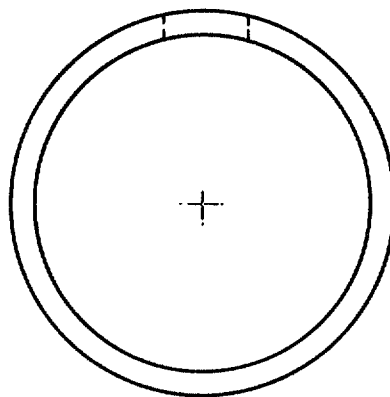
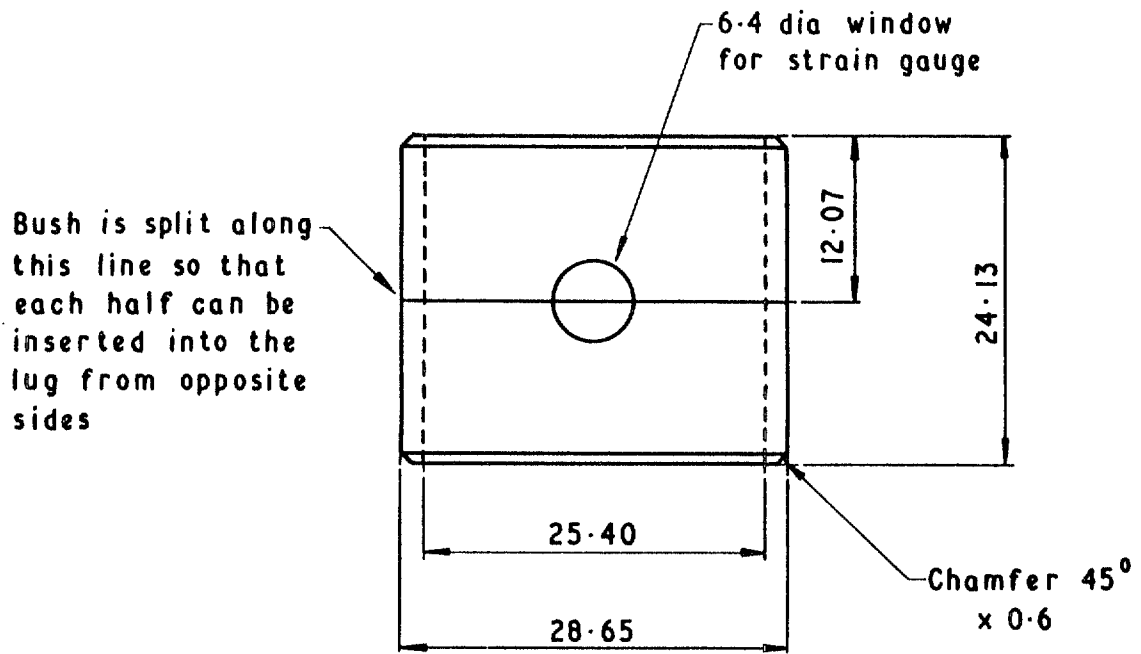

Fig 18 Lug used in companion specimen testing



Scale: 2:1
 Material: S80 steel
 Nominal dimensions in mm

Bush to be inserted into hole A in Fig18

Fig 19 Interference fit bush

Scale: $\frac{3}{4}$

Material: BS2L65

Nominal dimensions in mm

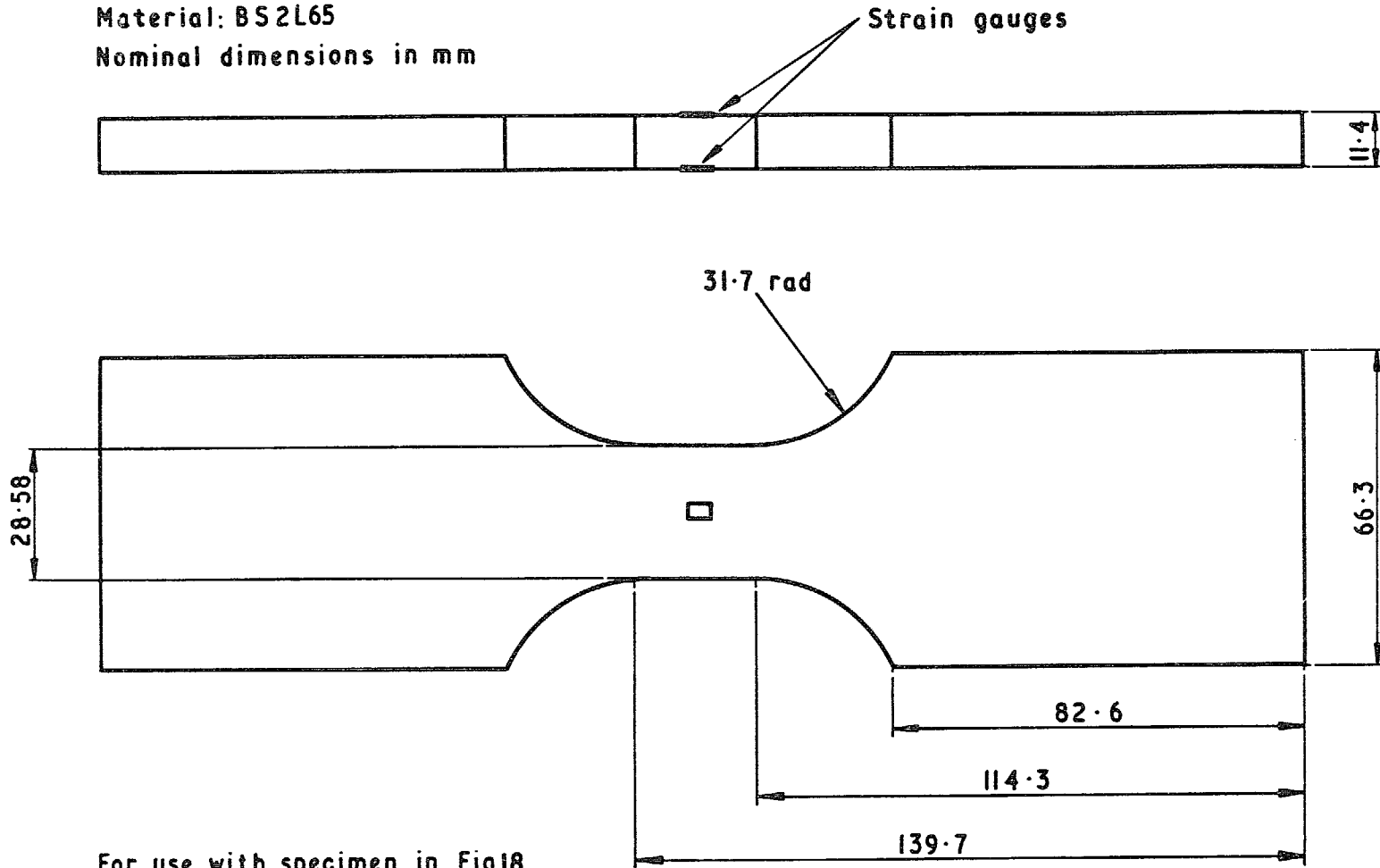

Fig 20 Plain specimen

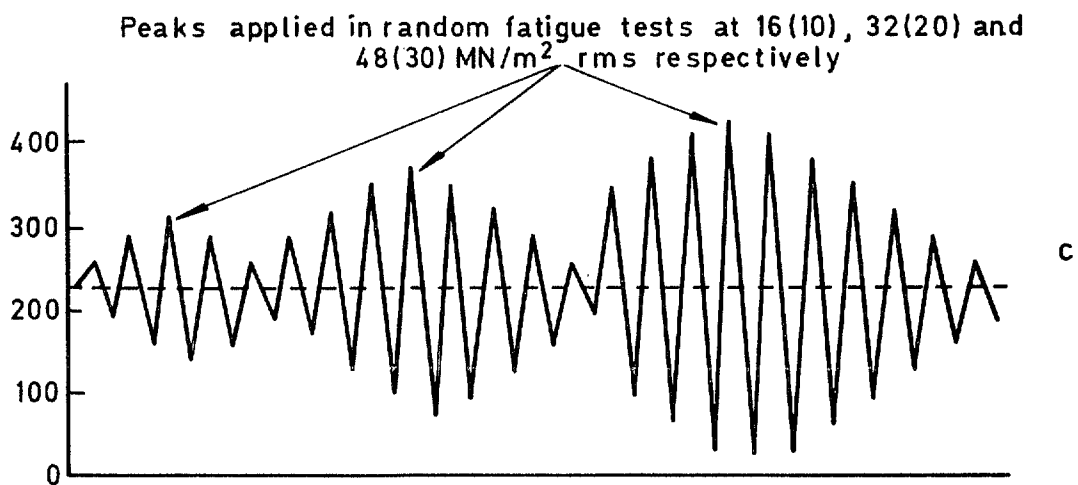
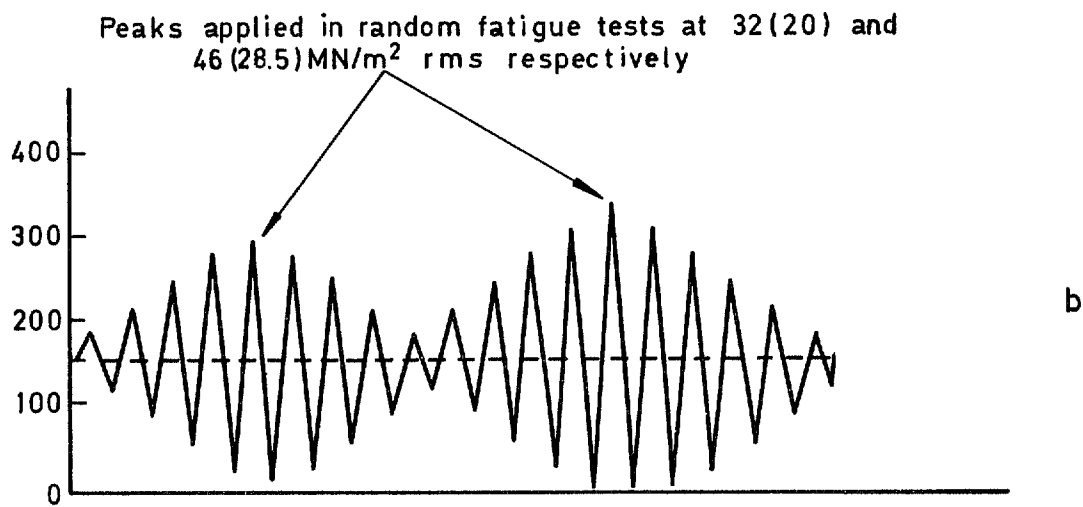
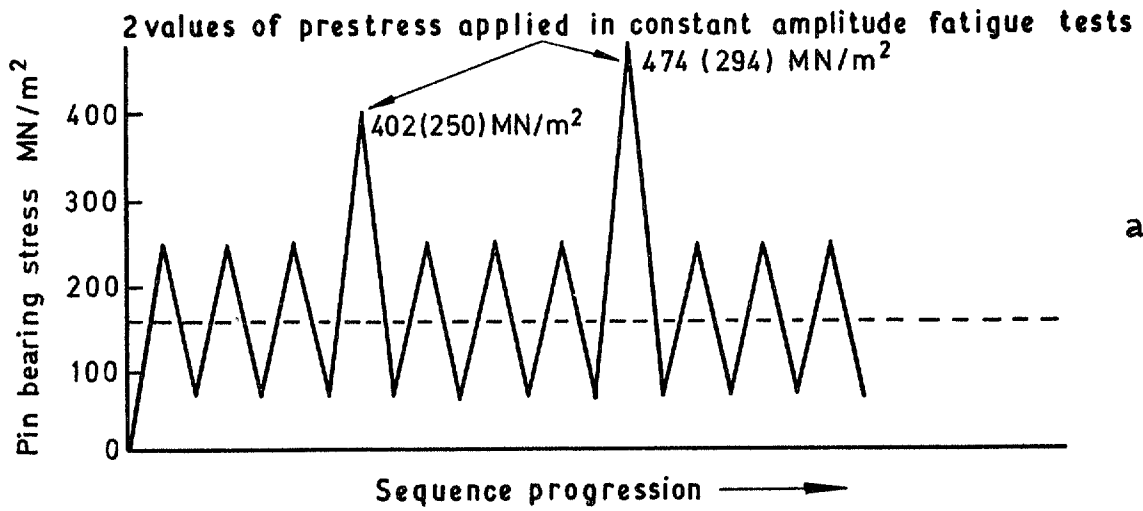

Fig 21a-c Sequences applied to lugs in Companion Specimen tests

Fig 22

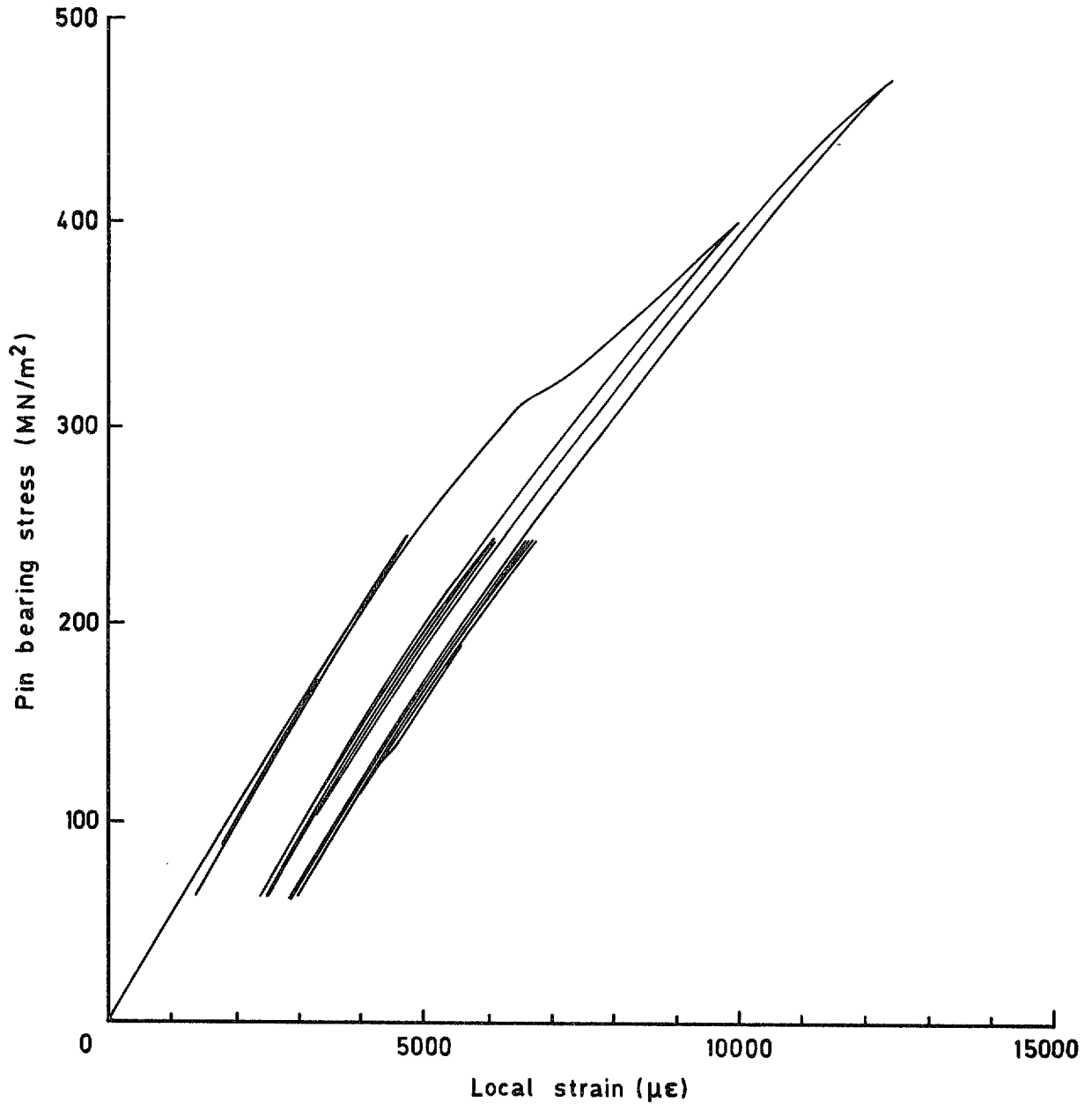

Fig 22 Pin bearing stress vs local strain diagram for lug with interference fit bush. Sequence (a)

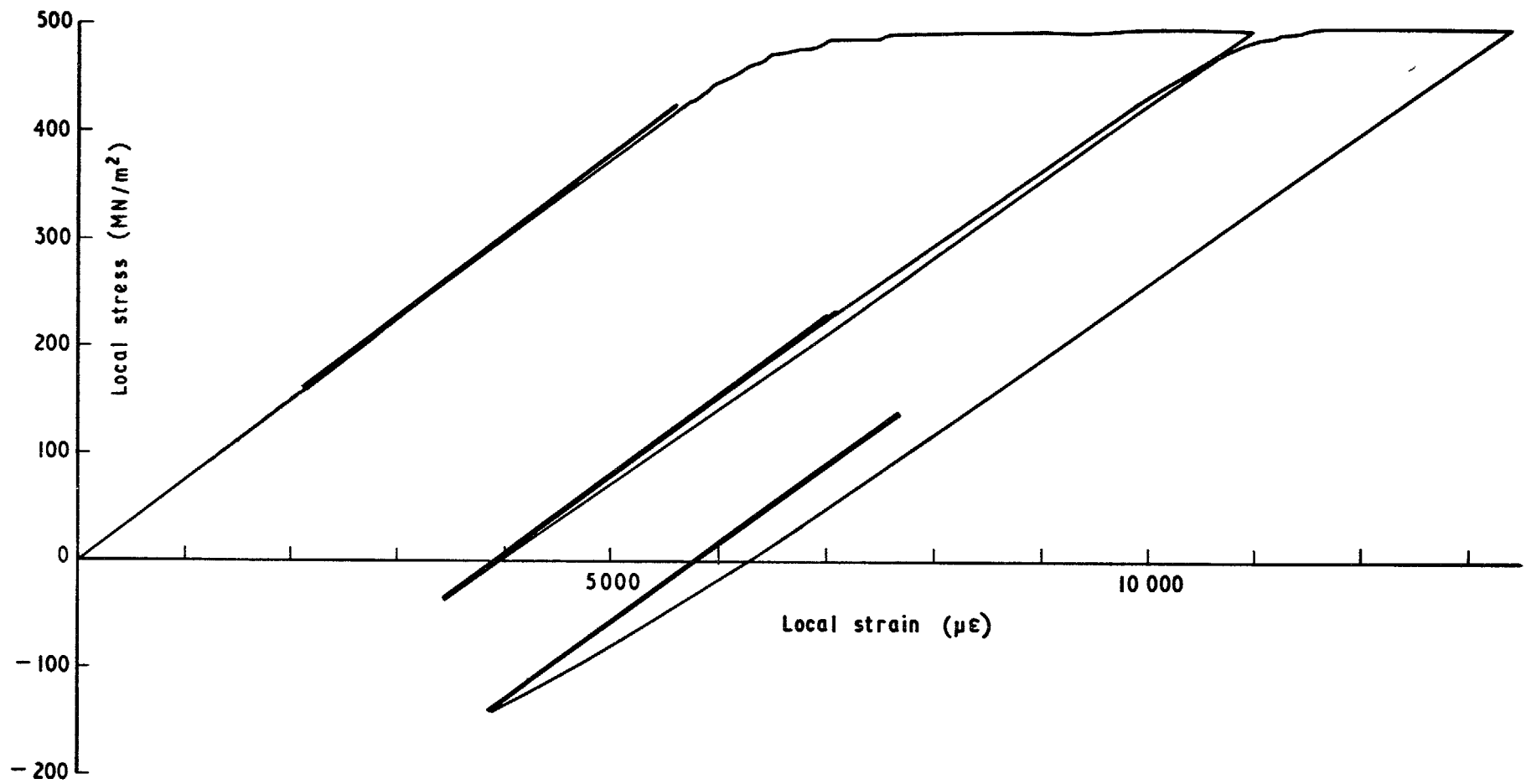

Fig 23 Companion plain specimen reproduction of local stress and local strain in a lug with an interference fit bush. Sequence (a)

Fig 24

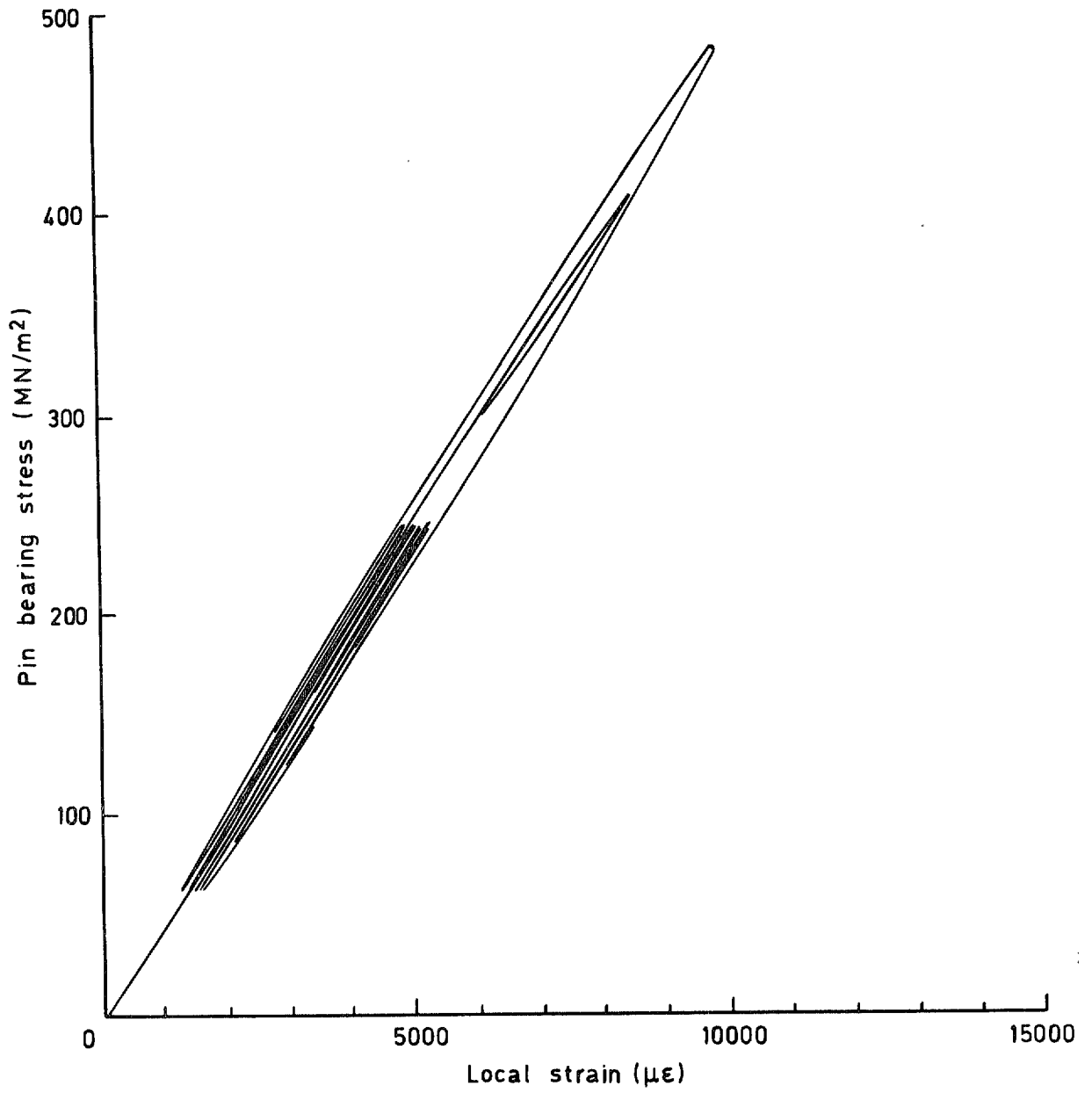

Fig 24 Pin bearing stress vs local strain diagram for lug with clearance fit pin.
Sequence (a)

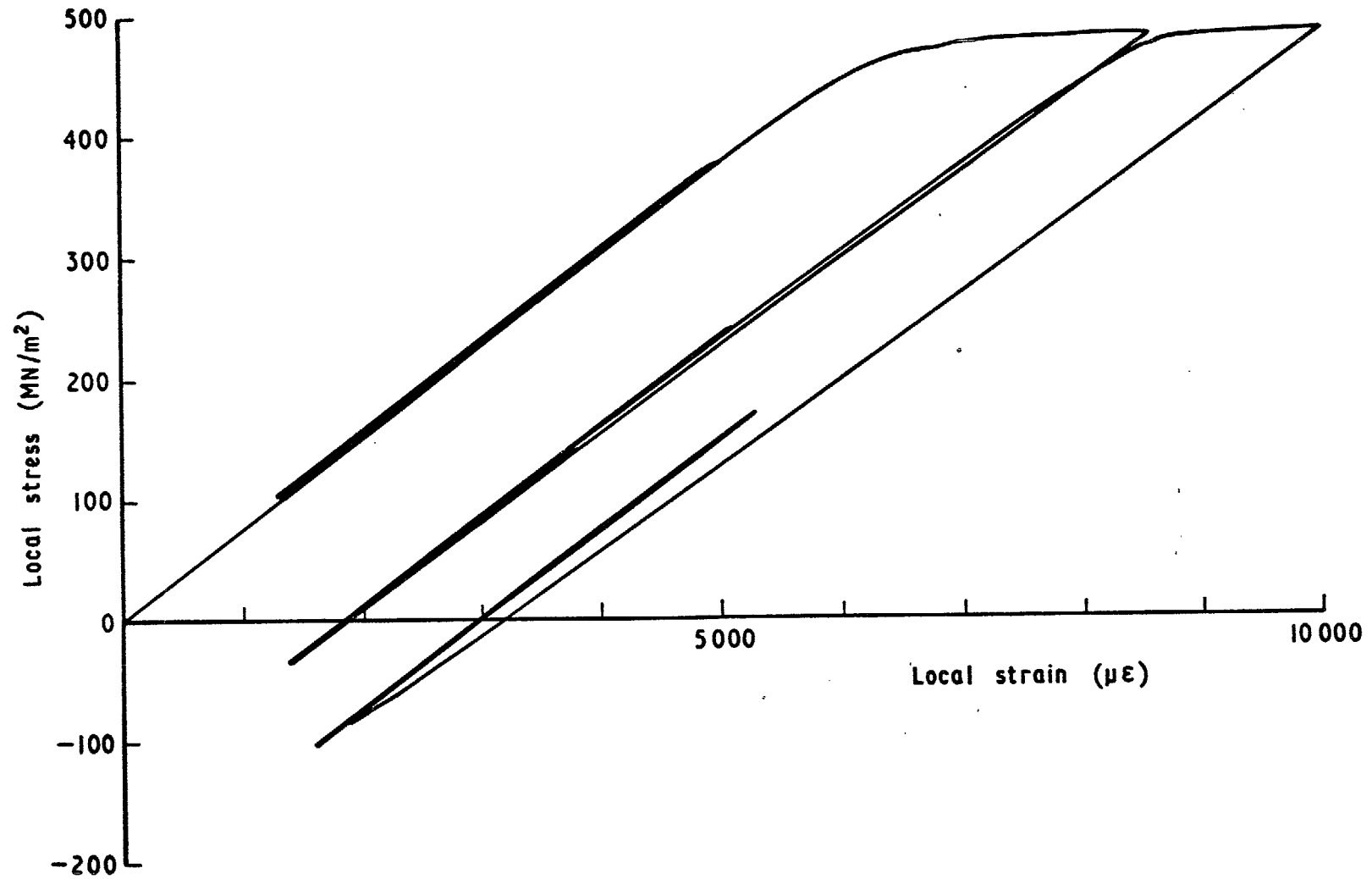

Fig 25 Companion plain specimen reproduction of local stress and local strain in a lug with a clearance fit pin. Sequence (a)

Fig 26

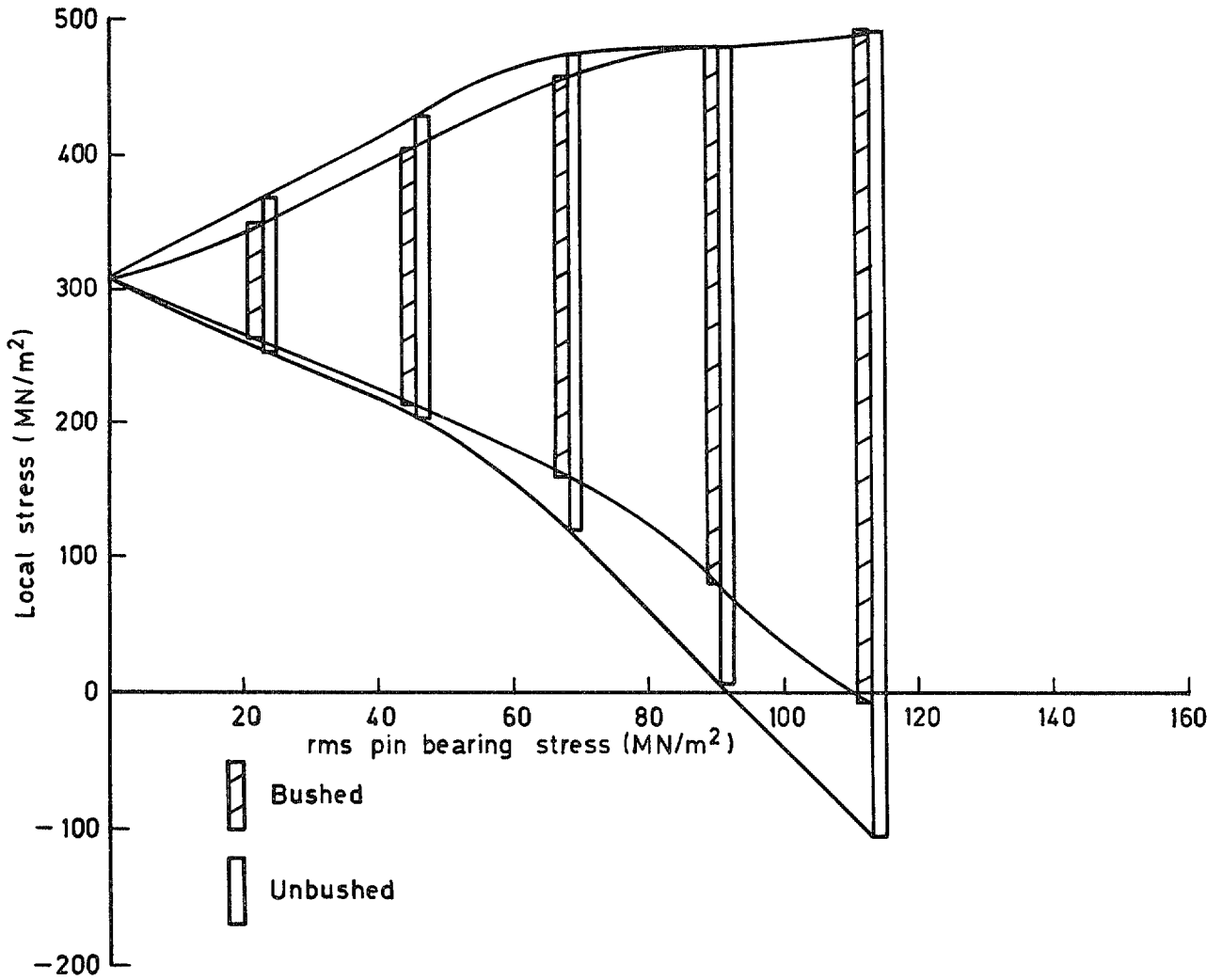

Fig 26 Comparison of local stress excursions in a bushed and an unbushed lug under constant amplitude loading at mean stress = 153(95) MN/m²

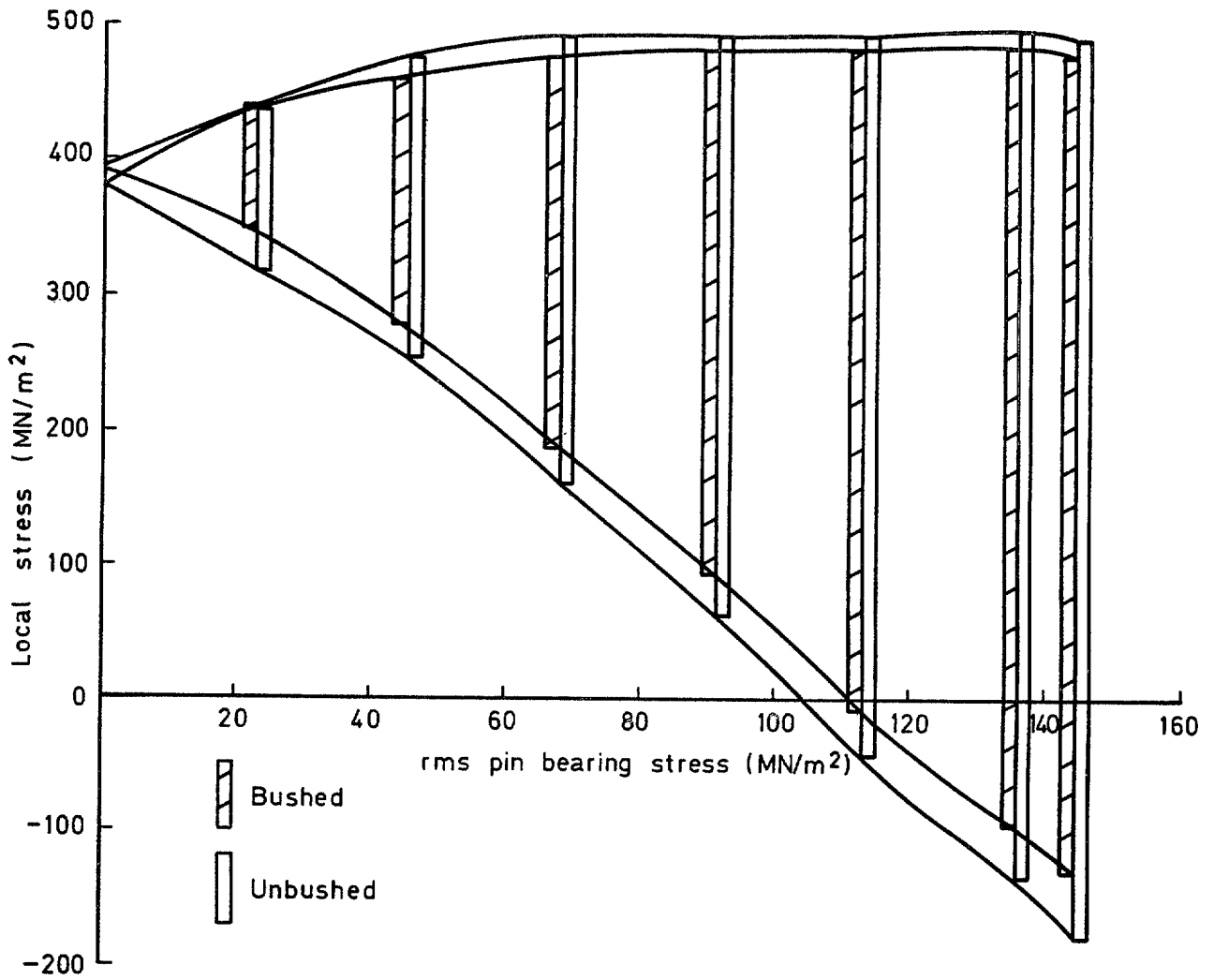

Fig 27 Comparison of local stress excursions in a bushed and an unbushed lug under constant amplitude loading at mean stress = 225(140) MN/m²

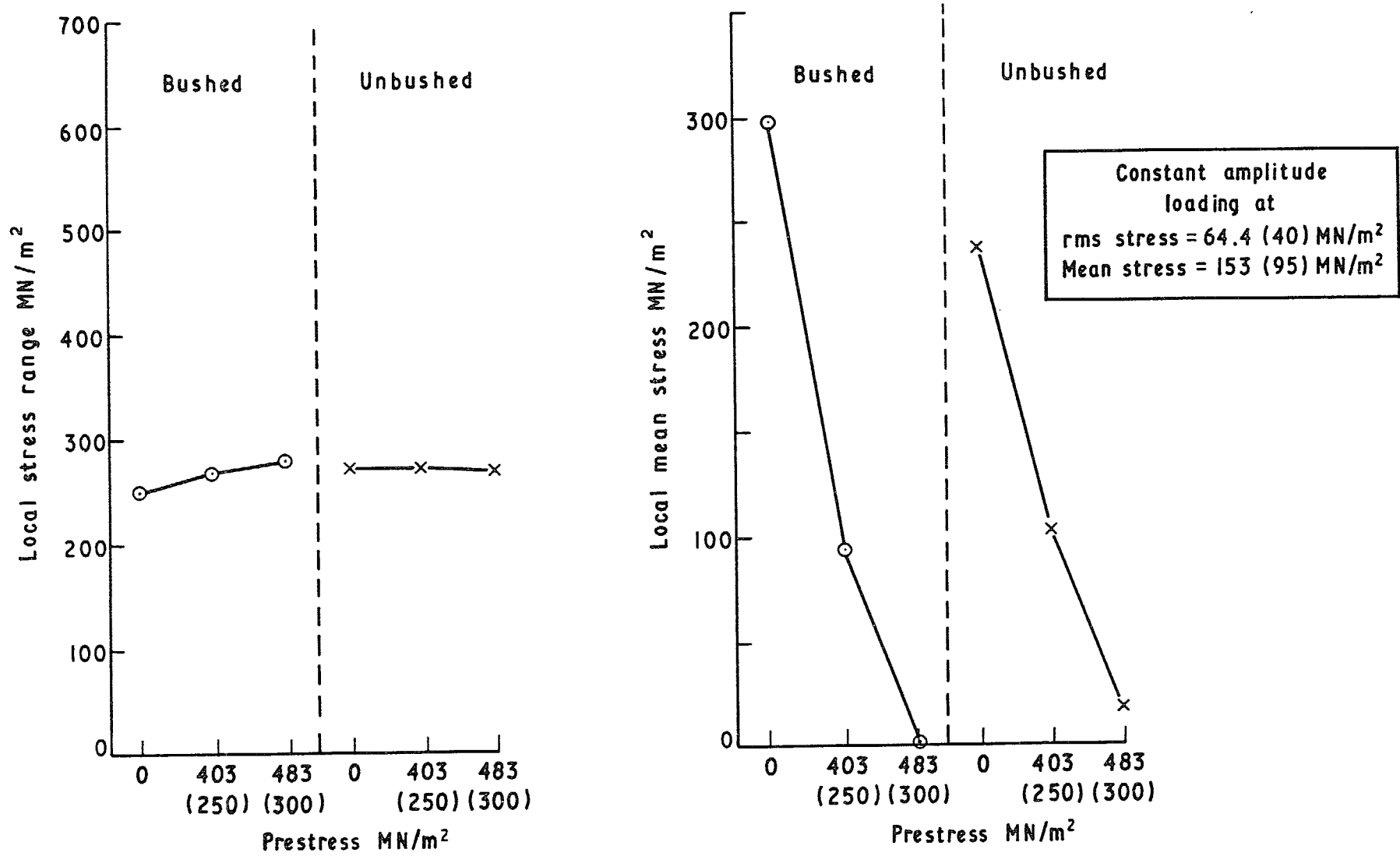
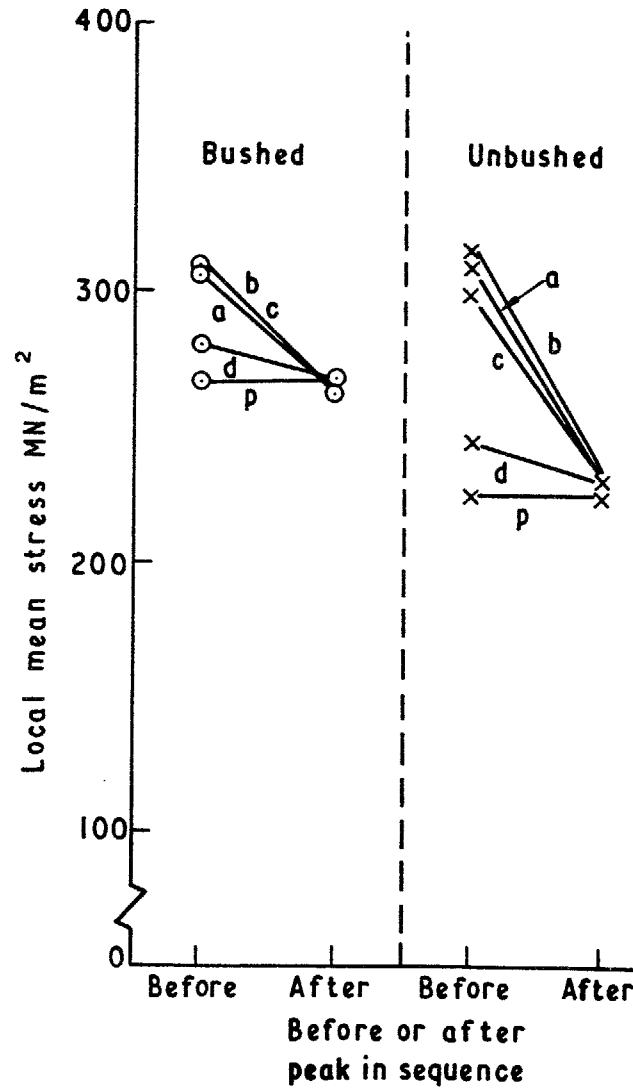
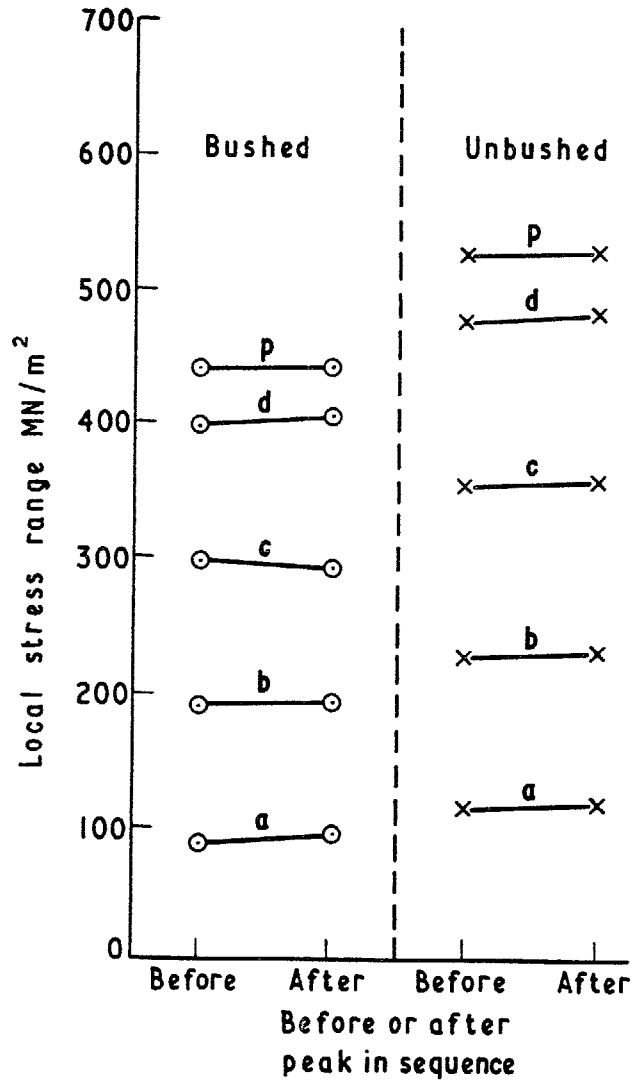

Fig 28 Effect of prestress on local stress histories during constant amplitude loading



Simulated NBR loading at:	
rms stress =	32.2 (20) MN/m ²
Mean stress =	153 (95) MN/m ²
Σ^n/N bushed =	1.8
Pin bearing stress range	
121 - 185	a
89 - 217	b
56 - 250	c
24 - 282	d
11 - 295	p
(peak)	

Fig 29 Effect of peak stress on local stress histories during subsequent smaller net stress cycles

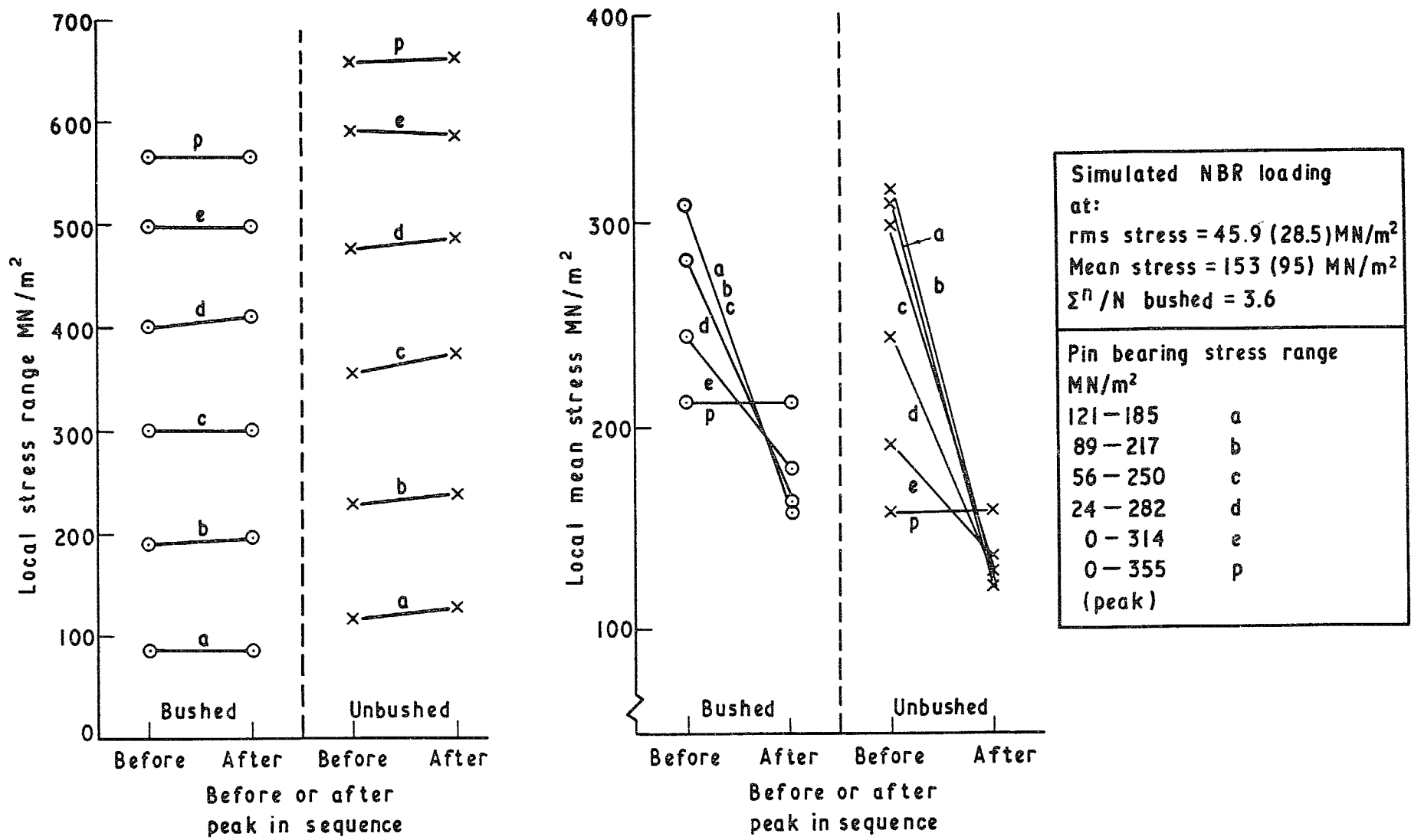
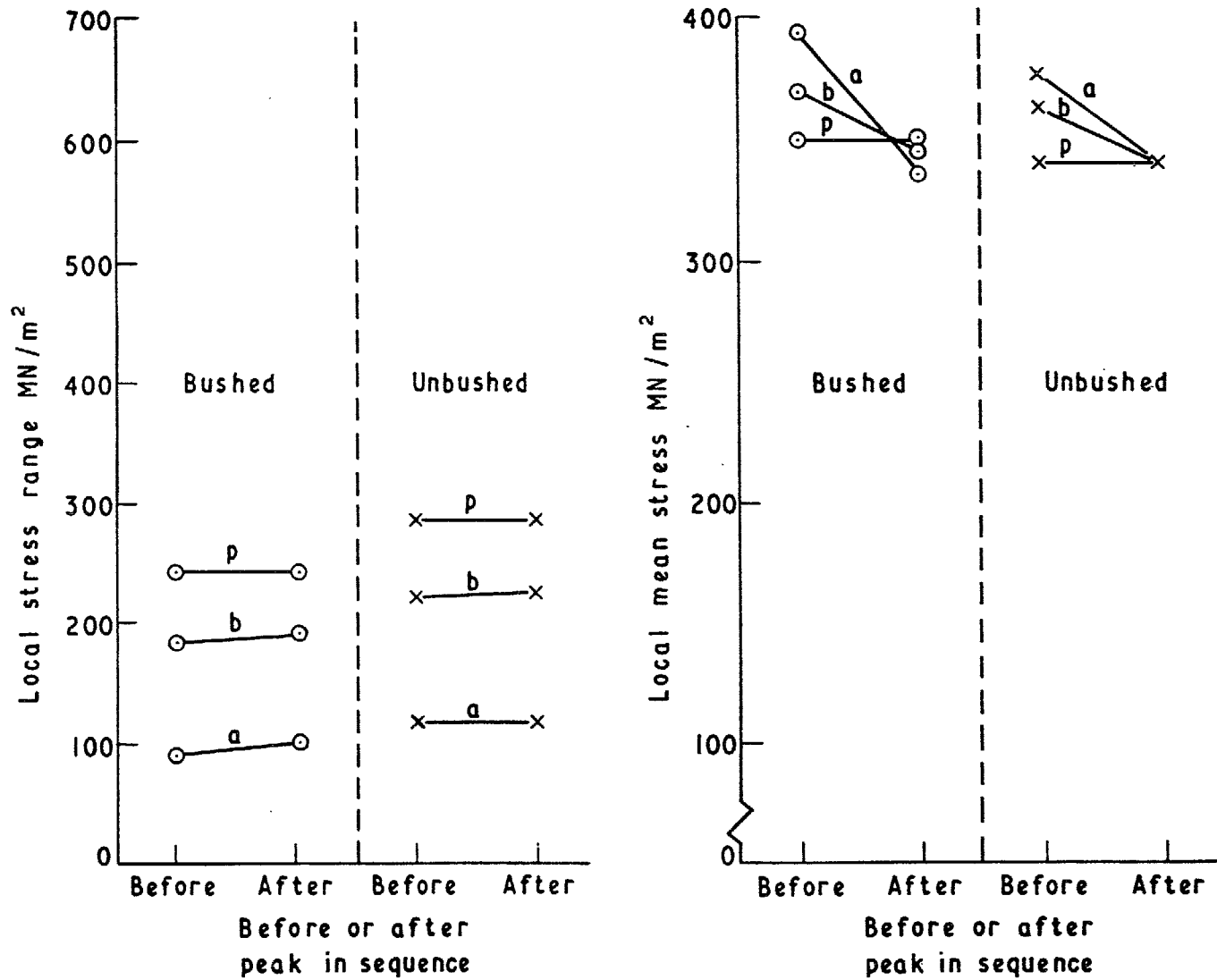

Fig 30 Effect of peak stress on local stress histories during subsequent smaller net stress cycles



Simulated NBR loading at:	
rms stress = 16.1 (10) MN/m ²	
Mean stress = 225.4 (140) MN/m ²	
Σ^n/M bushed = 3.2	
Pin bearing stress range	
MN/m ²	
193 - 258	a
161 - 290	b
14 - 309	p
(peak)	

Fig 31 Effect of peak stress on local stress histories during subsequent smaller net stress ranges

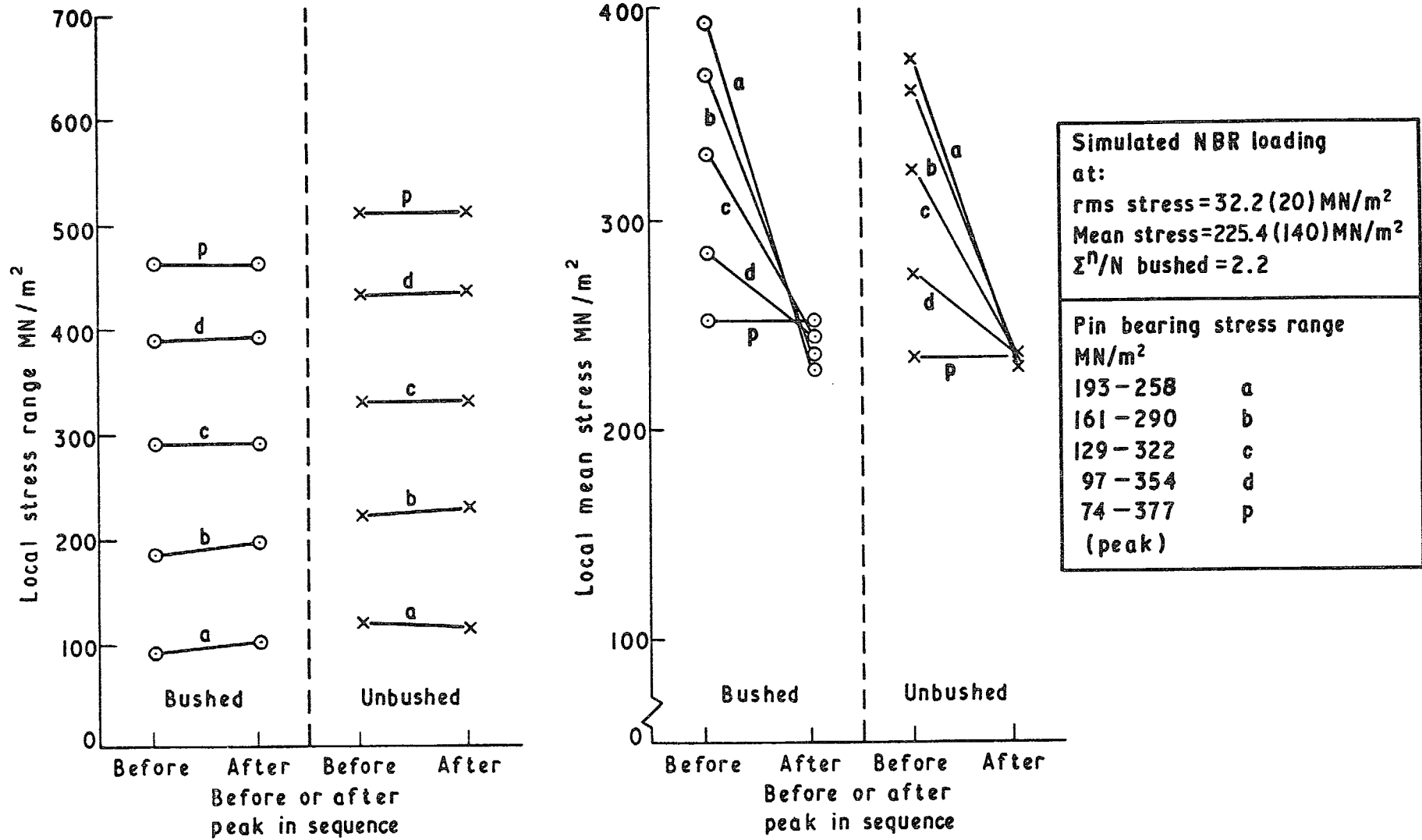

Fig 32 Effect of peak stress on local stress histories during subsequent smaller net stress cycles

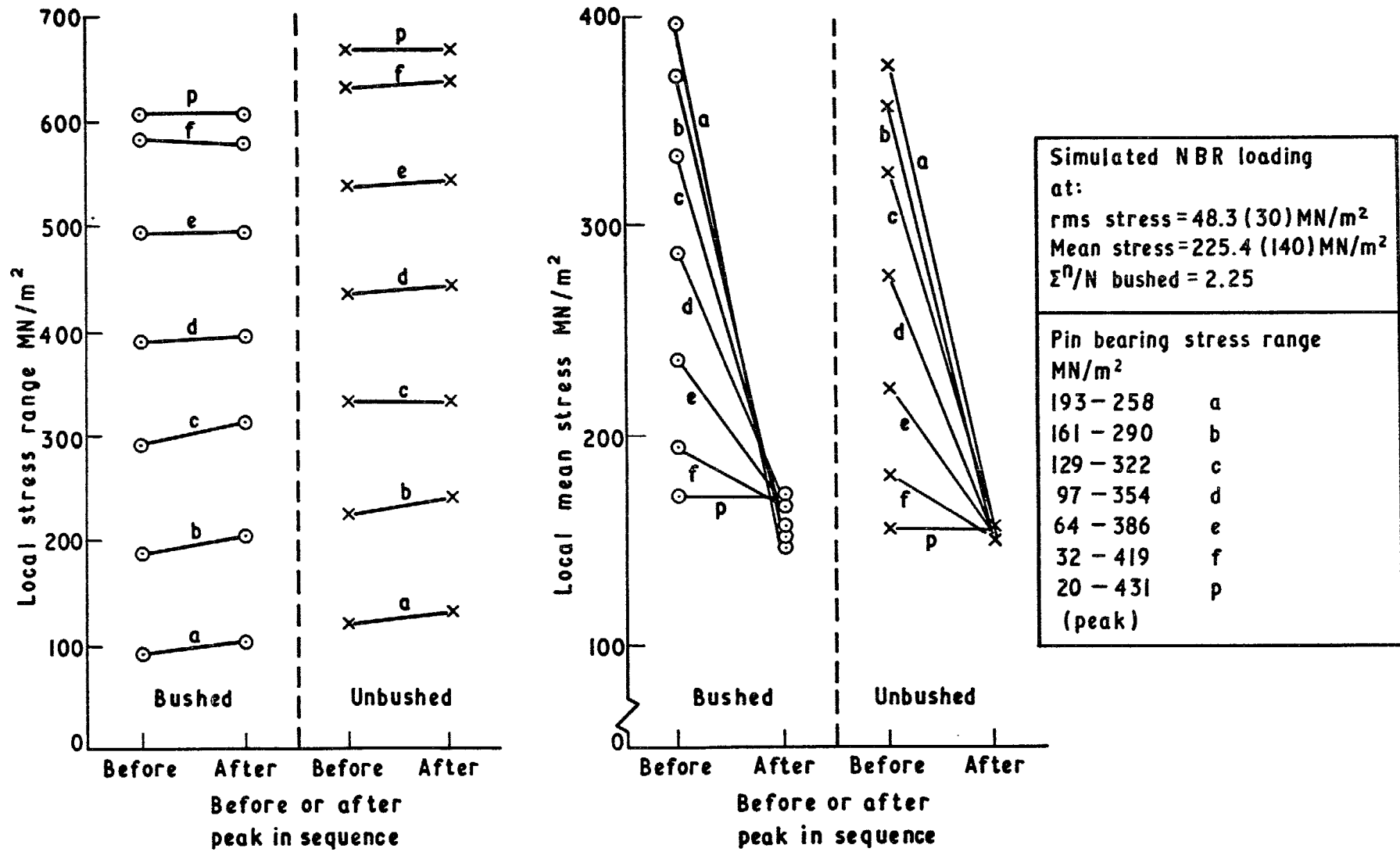

Fig 33 Effect of peak stress on local stress histories during subsequent smaller net stress cycles

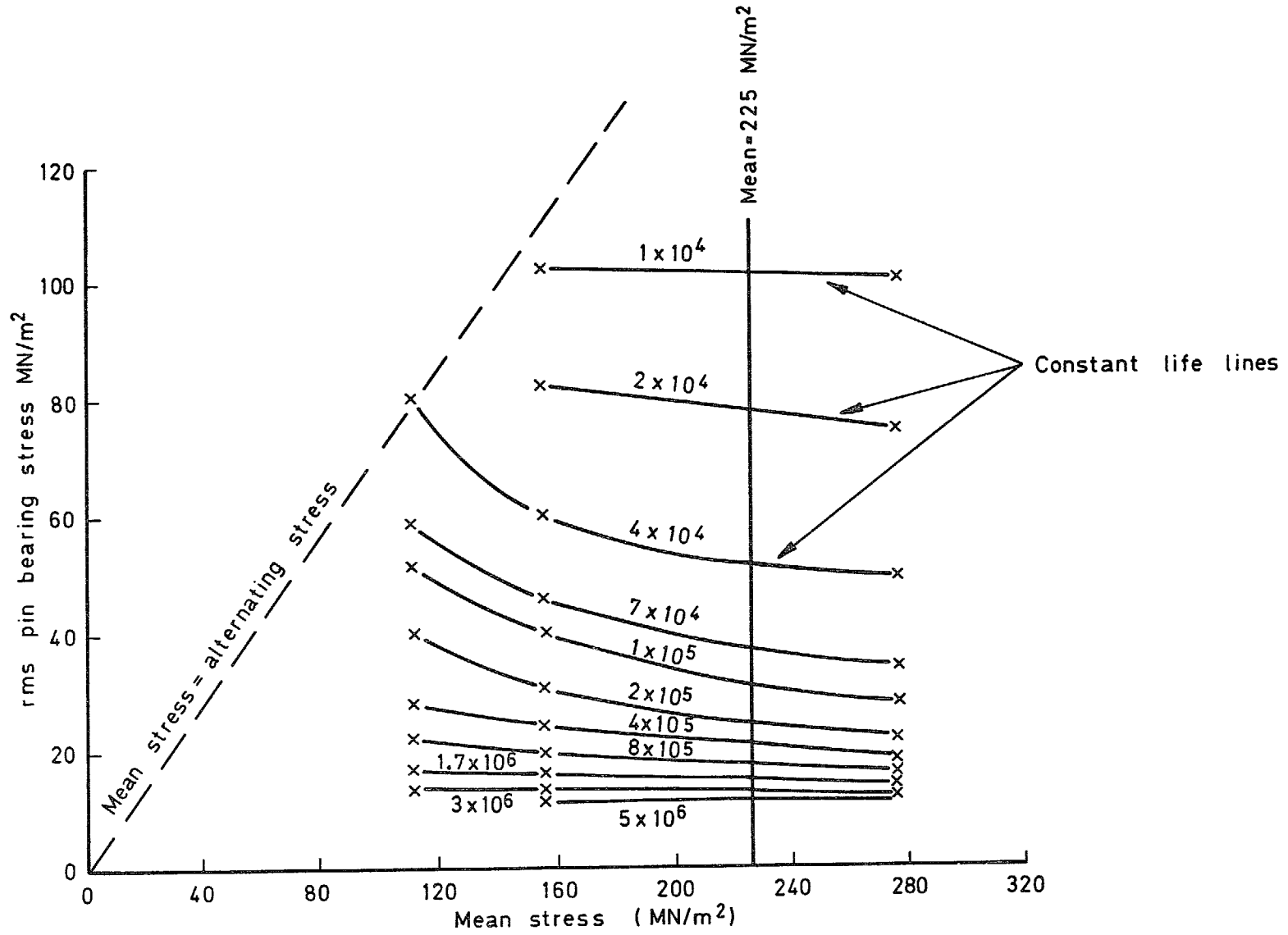

Fig 34 Alternating-mean stress diagram for unbushed lugs

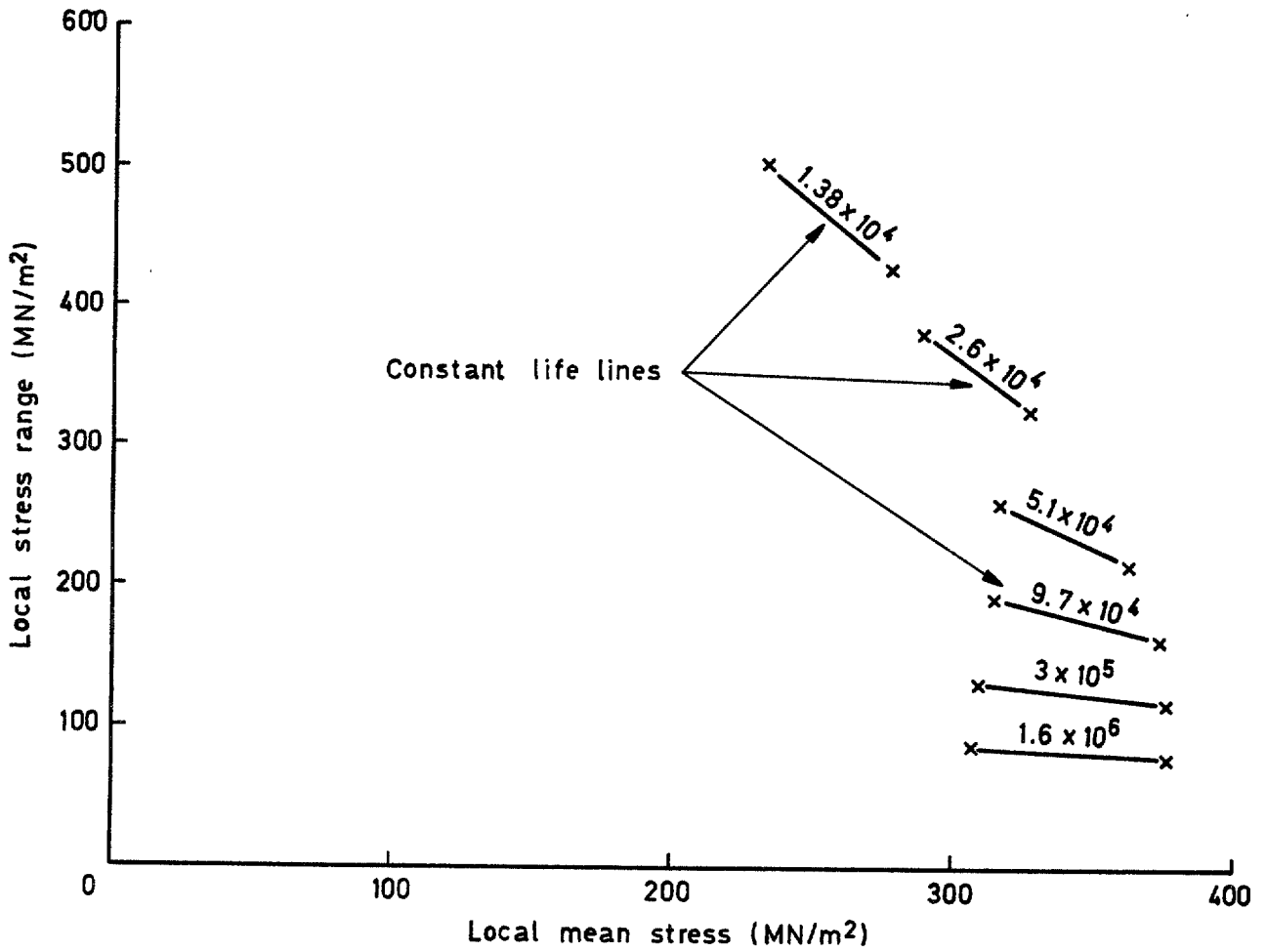

Fig 35 Local mean-local alternating stress diagram for unbushed lugs

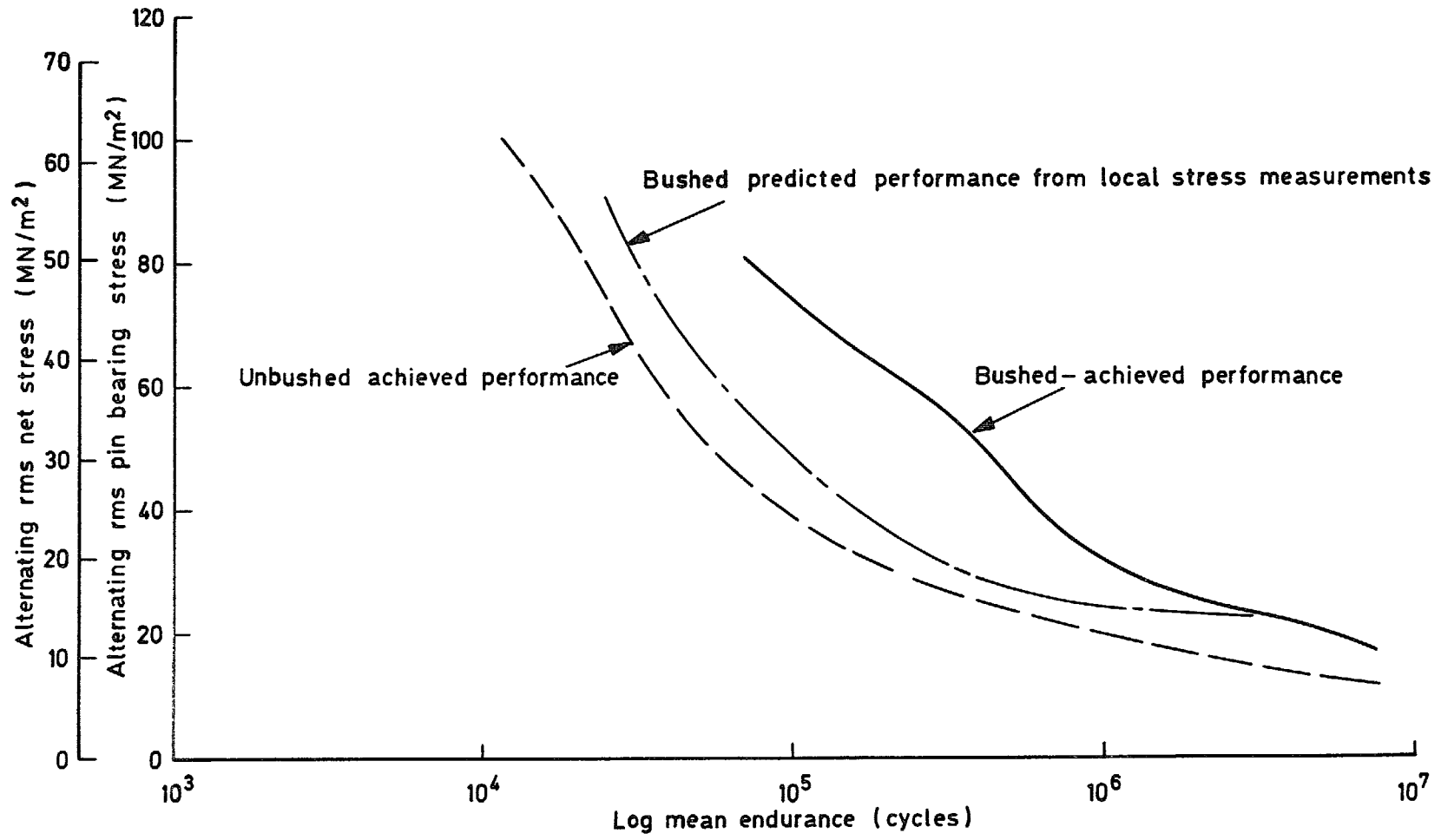

Fig 36 Estimation of endurance of bushed lugs using local stress history measurements. Mean stress = 153(95) MN/m²

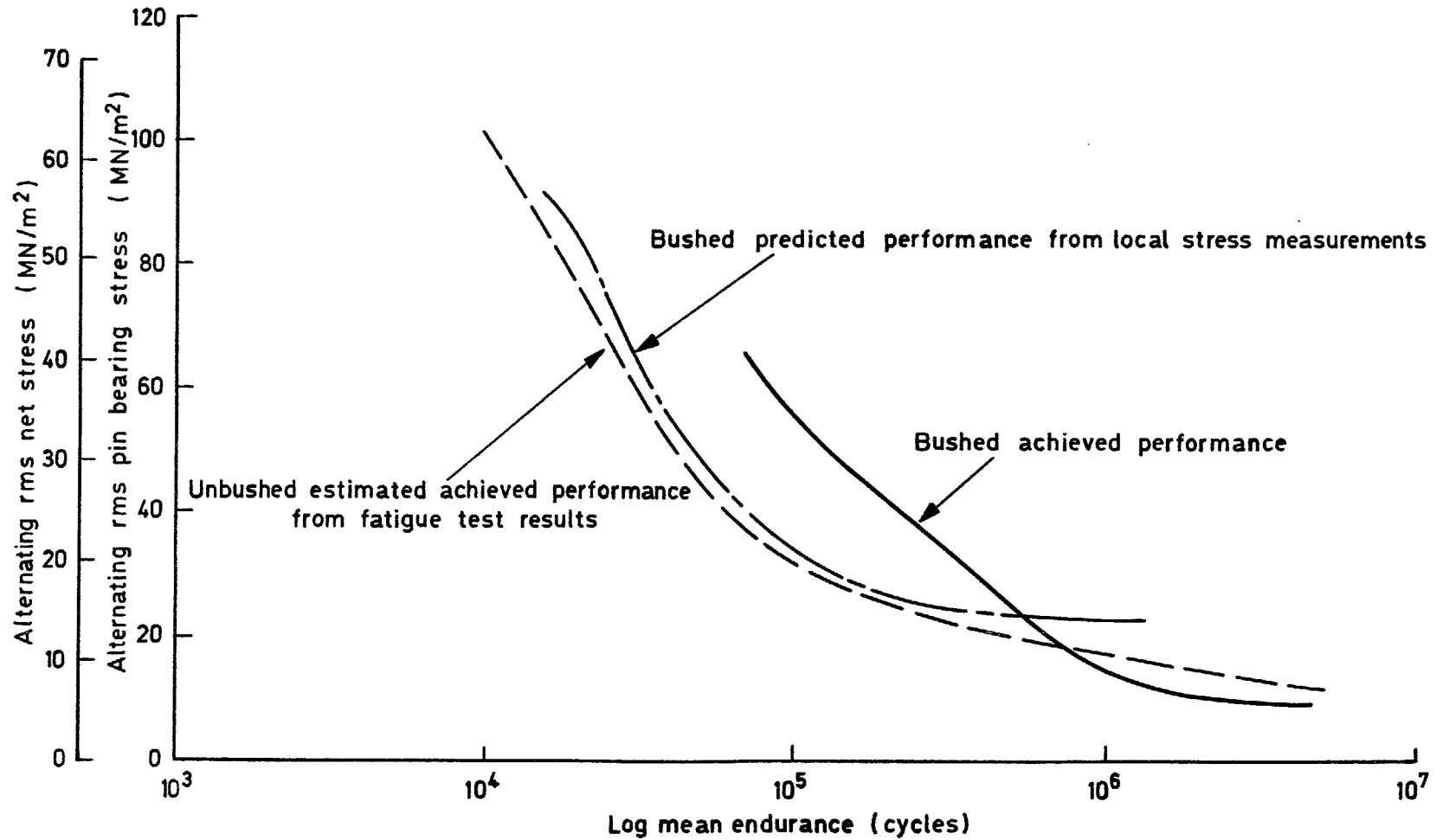

Fig 37 Estimation of endurance of bushed lugs using local stress history measurements. Mean stress = 225(140) MN/m^2

Fig 38

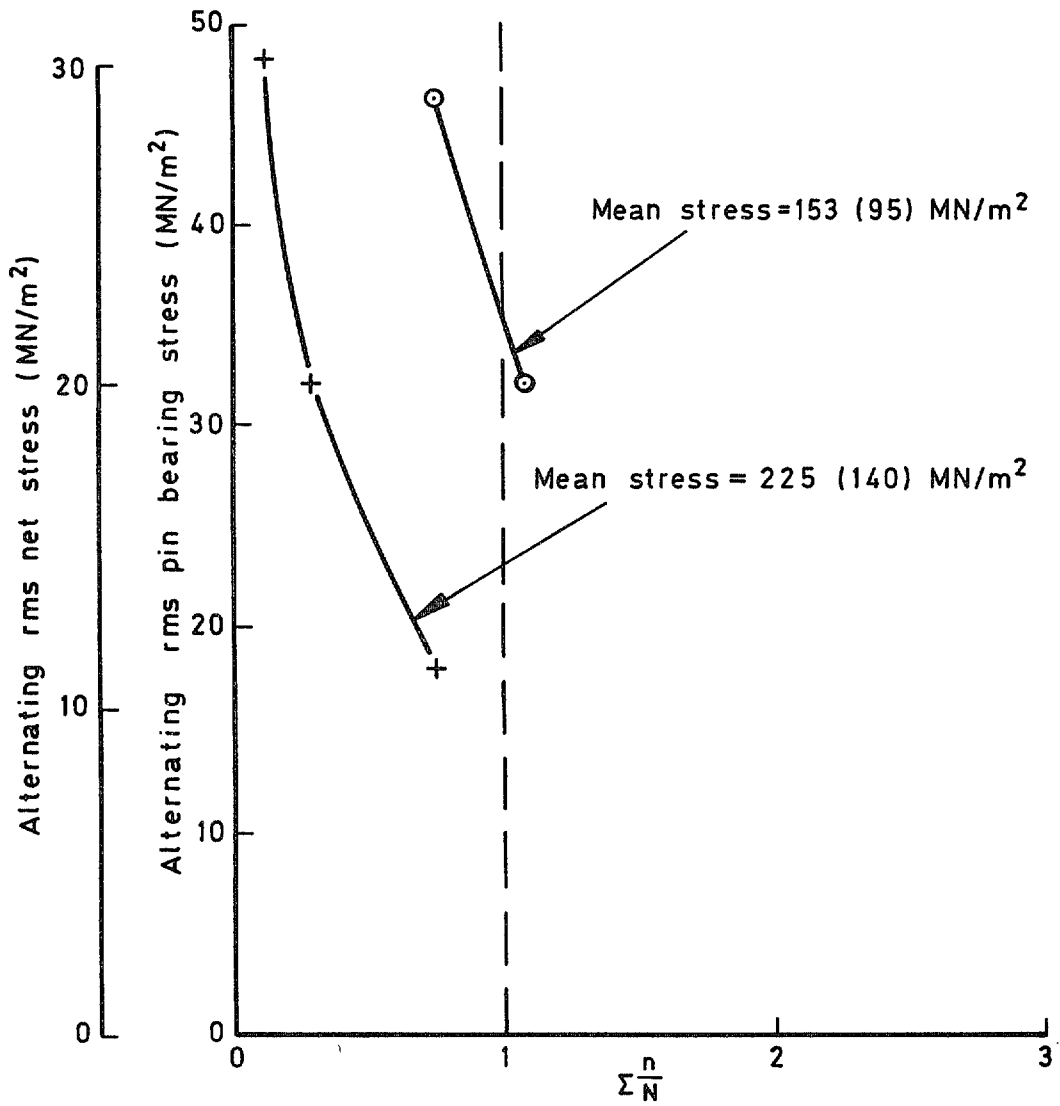

Fig 38 $\Sigma \frac{n}{N}$ values for lugs with interference fit bushes under NBR loading with allowance for residual stresses induced by peak loads in spectrum

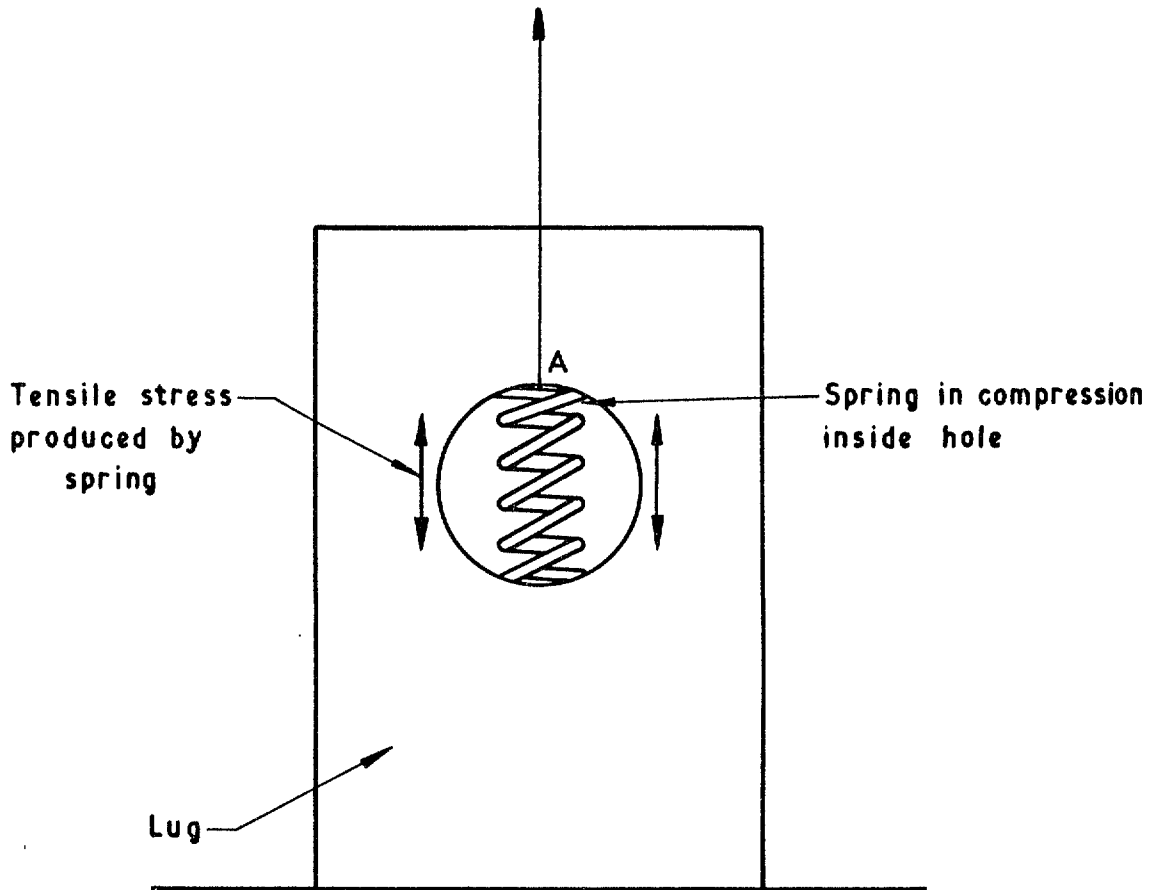

Fig 39 Simulation of bush by a spring in compression

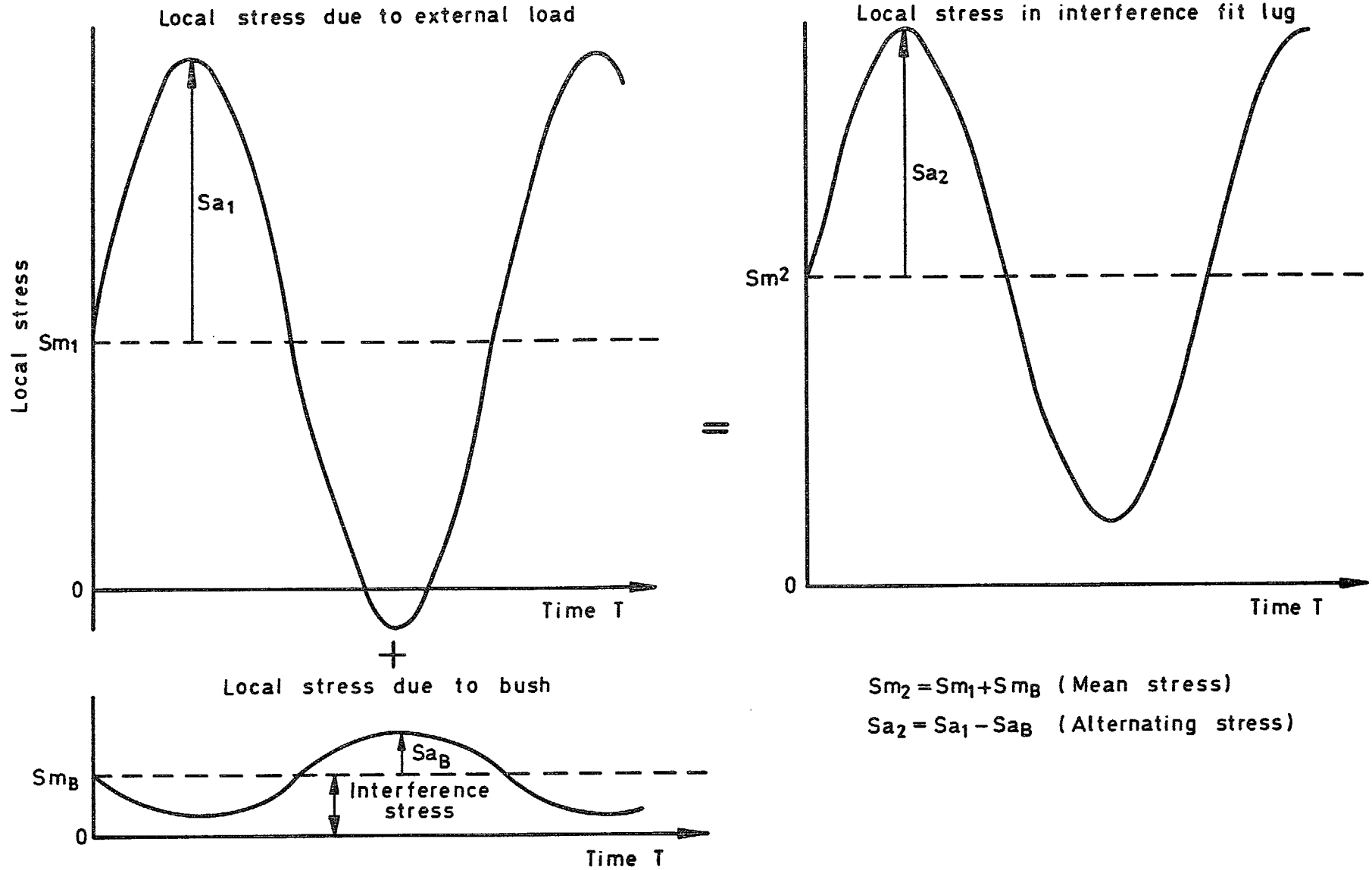

Fig 40 Effect of bush on local stress history in a lug

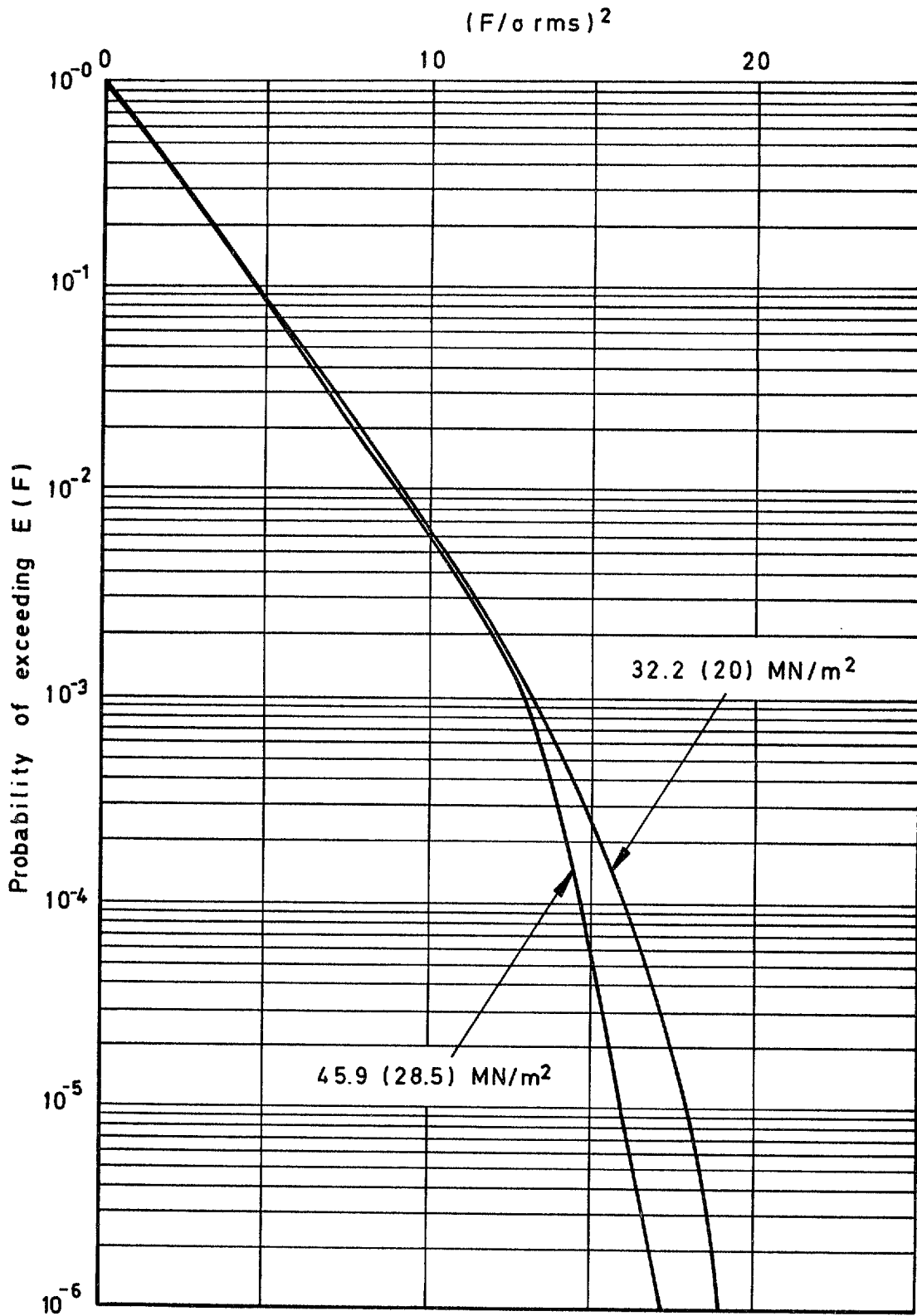

Fig 41 Measured load spectra at mean stress = 153(95) MN/m² at various rms alternating stress levels

Fig 42

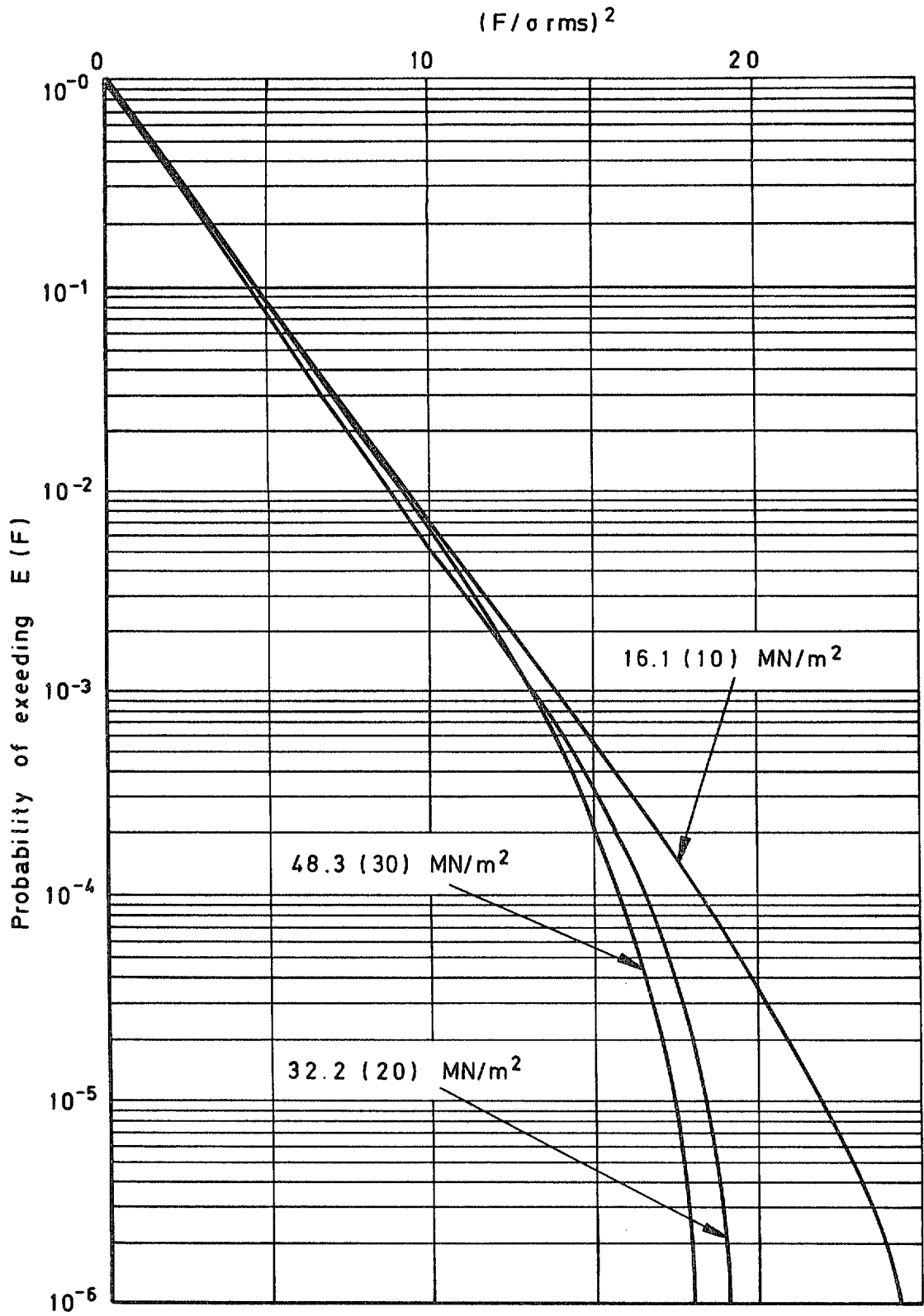

Fig 42 Measured load spectra at mean stress = 225(140) MN/m² at various rms alternating stress levels

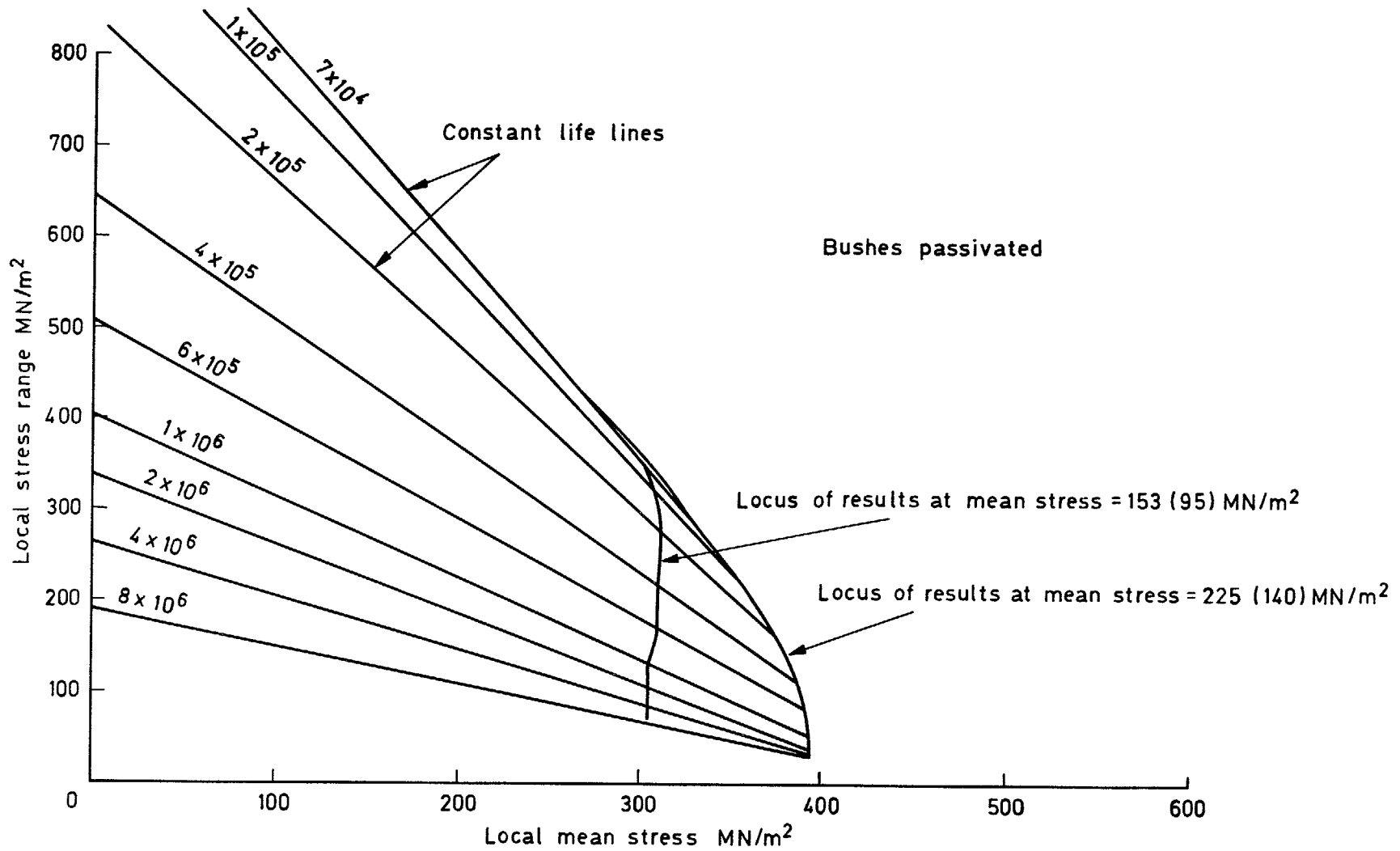

Fig 43 Local mean-local alternating stress diagram for bushed lugs

© Crown copyright 1979
First published 1979

HER MAJESTY'S STATIONERY OFFICE

Government Bookshops

49 High Holborn, London WC1V 6HB

13a Castle Street, Edinburgh EH2 3AR

41 The Hayes, Cardiff CF1 1JW

Brazennose Street, Manchester M60 8AS

Southey House, Wine Street, Bristol BS1 2BQ

258 Broad Street, Birmingham B1 2HE

80 Chichester Street, Belfast BT1 4JY

*Government Publications are also available
through booksellers*

R & M No.3835

ISBN 011 471168 2