

ST. NO. R. 107

U.D.C. 61-

AUTH.

R. & M. No. 1983

(6973)

A.R.C. Technical Report



MINISTRY OF AIRCRAFT PRODUCTION

AERONAUTICAL RESEARCH COMMITTEE  
REPORTS AND MEMORANDA

Torsiograph Observations on a Merlin II Engine,  
using a Serrated-Condenser Pick-Up, with Five  
Different Pitch Settings of the Propeller Blades

By

B. C. CARTER, M.I.Mech.E., and J. R. FORSHAW, M. Eng.

STACK FILE

*Crown Copyright Reserved*

LONDON: HIS MAJESTY'S STATIONERY OFFICE

Price 4s. od. net

# Torsiograph Observations on a Merlin II Engine, using a Serrated-Condenser Pick-Up, with Five Different Pitch Settings of the Propeller Blades

By

B. C. CARTER, M.I.Mech.E., and J. R. FORSHAW, M. Eng.



Communicated by the Director of Scientific Research, Ministry of Aircraft Production.

*Reports and Memoranda No. 1983*

*July, 1943\**



*Summary.—Introduction.*—This report is based upon the first application of the torsiograph described in Reference 1, the observations being made in the course of development of the instrument. Subsequent applications have been to Merlin 61 and Sabre engines, with results which are given elsewhere.

*Range of Investigation.*—The torsiograph pick-up unit was fixed into the pinion-driving shaft of a Merlin II engine on a hangar test-bed and records were obtained at various crankshaft speeds from 900 r.p.m. to 3,000 r.p.m., and with blade settings: 16.5 deg., 20.5 deg., 22.5 deg., 25.5 deg. and 29 deg., measured from the propeller disc at 42 inches from the shaft axis.

The observed cyclical torque oscillations have been analysed into harmonic components and the causes of the corresponding modes of vibration are examined in the report. To assist this examination, some vibrograph observations were made and also a mathematical analysis, which is given in the Appendix.

*Conclusions.*—There were three predominant modes of "torsion-bending" vibration, for which the blade-bending vibrations were: fundamental flapping, first overtone flapping, and a combined fundamental edgewise and first overtone flapping; at 15 deg. pitch angle, the respective frequencies were 3,150, 5,000 and 6,050 c.p.m.

Owing to the proximity of the natural frequency of the system in the axial direction to the frequencies for fundamental and first-overtone torsion-bending modes, the axial-bending mode of vibration was strongly coupled with these torsion-bending modes. The torsional components of these complex coupled modes were recorded by the torsiograph and the frequencies were found to be 4,200 and 5,600 c.p.m. for 15 deg. pitch; the magnitudes were comparable with those for the torsion-bending modes. It is probable that the coupling occurred between torsion-bending and rolling oscillation of the engine on its mounting, but this hypothesis was not supported by the vibrograph observations whereas appropriate axial vibration was recorded by vibrograph.

The resonant frequencies for all modes of vibration decreased with increase of blade pitch except for the first-overtone-propeller torsion-bending mode, which was almost a fixed-root mode of vibration and only changed in frequency at the higher pitch angles, for which the frequency increased a little.

The fall of resonant frequency with increase of pitch is inconsistent with the accepted torsion-bending theory assuming a rigidly held thrust race and it is doubtful whether a full explanation can be found without further experiments in which changes are made in the rigidity of the engine mounting.

By plotting calculated deflection diagrams for the torsional system, it was found that the modes of vibration with an antinode in the shaft containing the torsiograph occurred at 19,000 c.p.m. and 34,000 c.p.m. As the torsiograph can give no indication of resonance at these frequencies, it is clear that for complete investigation of the torsional vibration it would be necessary to make observations with two torsiographs, thereby avoiding "blind spots" in the frequency range.

Judging from the corresponding stresses in the crankshaft, the two-noded mode of crankshaft torsional vibration appears to be relatively unimportant but it has been found that this mode of vibration may give rise to high stresses in the propeller blades.

Throughout the records, a 21st engine order vibration of small magnitude was present, which was caused by tooth engagement, and a 42nd engine order vibration was present on some of the records.

The conclusions reached in the present investigation are in certain respects somewhat tentative because they are based upon observations made at only two points in a highly complex vibrating system.

\* R.A.E. Report No. E.3976, received 20th August, 1943.

1. *Introduction.*—The observations were made to obtain precise information concerning the torque oscillation in the pinion-driving shaft of a Merlin engine by means of the new instrument described in Reference 1 and to determine, in particular, how this oscillation is affected by propeller pitch angle.

It was found that the observations could not be accounted for completely on the basis that the propeller shaft thrust race and axis are fixed in space. Accordingly, vibrograph observations were made on the engine to determine some of its oscillations in space. These observations showed that axial movement had an important place in the torsigraph results and, in order to gain a fuller understanding of the coupling effects that may arise between axial oscillation of the hub and torsional-flexural vibration of the crankshaft-propeller system, the behaviour of idealised systems was examined analytically. This analysis is given in the Appendix.

It happened that, in the wide range of vibration frequencies explored, modes of vibration occurred such that the pinion-driving shaft was at a torsional antinode. For the corresponding vibration frequencies there is, in effect; a "blind spot" in the torsigraph records: to explore these modes would involve making observations with two torsigraphs.

The experiments were carried out with the engine mounted on a built-up hangar-bed structure as shown in Fig. 1.

2. *Particulars of the Engine and Propeller.*—The following are some particulars of the engine and propeller used for the experiments.

| Engine.                |    |    |    | Propeller.          |                    |    |    |   |
|------------------------|----|----|----|---------------------|--------------------|----|----|---|
| Name                   | .. | .. | .. | Merlin II           | Name               | .. | .. | de Havilland  |
| Serial No.             | .. | .. | .. | 1959                | Serial No.         | .. | .. | 5678  |
| Type                   | .. | .. | .. | 12 cylinder 60° Vee | Type               | .. | .. | 5/4 bracket type, with fine and coarse pitch settings |
| Bore                   | .. | .. | .. | 5.4 in.             | No. of blades      | .. | .. | 3   |
| Stroke                 | .. | .. | .. | 6 in.               | Material of blades | .. | .. | Duralumin   |
| Reduction gear ratio   | .. | .. | .. | 0.42 to 1           | Diameter           | .. | .. | 12 ft. 6 in.  |
| Compression ratio      | .. | .. | .. | 6 to 1              | Weight             | .. | .. | 368 lb.   |
| Forked connecting rods | .. | .. | .. | 9.9 in. centres     | Moment of inertia  | .. | .. | 1,330 lb./ft. <sup>2</sup>                            |

General: The equivalent dynamic system is shown in Fig. 8—ignoring the supercharger and driven accessories.  
Aircraft for which designed: Battle I.

3. *Description of Experiments.*—The R.A.E. serrated-condenser pick-up unit<sup>1</sup> was expanded into the pinion-driving shaft and coupled to a contact type slip-ring unit. The latter is shown in Fig. 1 fitted in place of the constant-speed unit in front of the reduction gear casing below the propeller shaft.

The blade-pitch operating cylinder was held at its outer limit by engine oil pressure, and torsigraph records were obtained with the blades set in five successive positions, namely:—

16.5 deg.; 20.5 deg.; 22.5 deg. and 29 deg. at 42 inches from the shaft axis.

The spot of the cathode ray tube of the accompanying electronic apparatus was photographed with a moving-film camera and records such as those shown in Ref. 1 obtained. Time markings were made on the records by using a 50 c.p.s. tuning fork and engine-driven contacts were used to give markings on the record once per two crankshaft revolutions.

It was found that the only clearly defined resonance that could be observed on the cathode-ray screen occurred at 2,000 crankshaft r.p.m. Photographic records were taken in steps of 100 r.p.m. from 1,000 r.p.m. to the speed which was obtained at the maximum boost (6¼ lb. per sq. in.) with the several pitch settings.

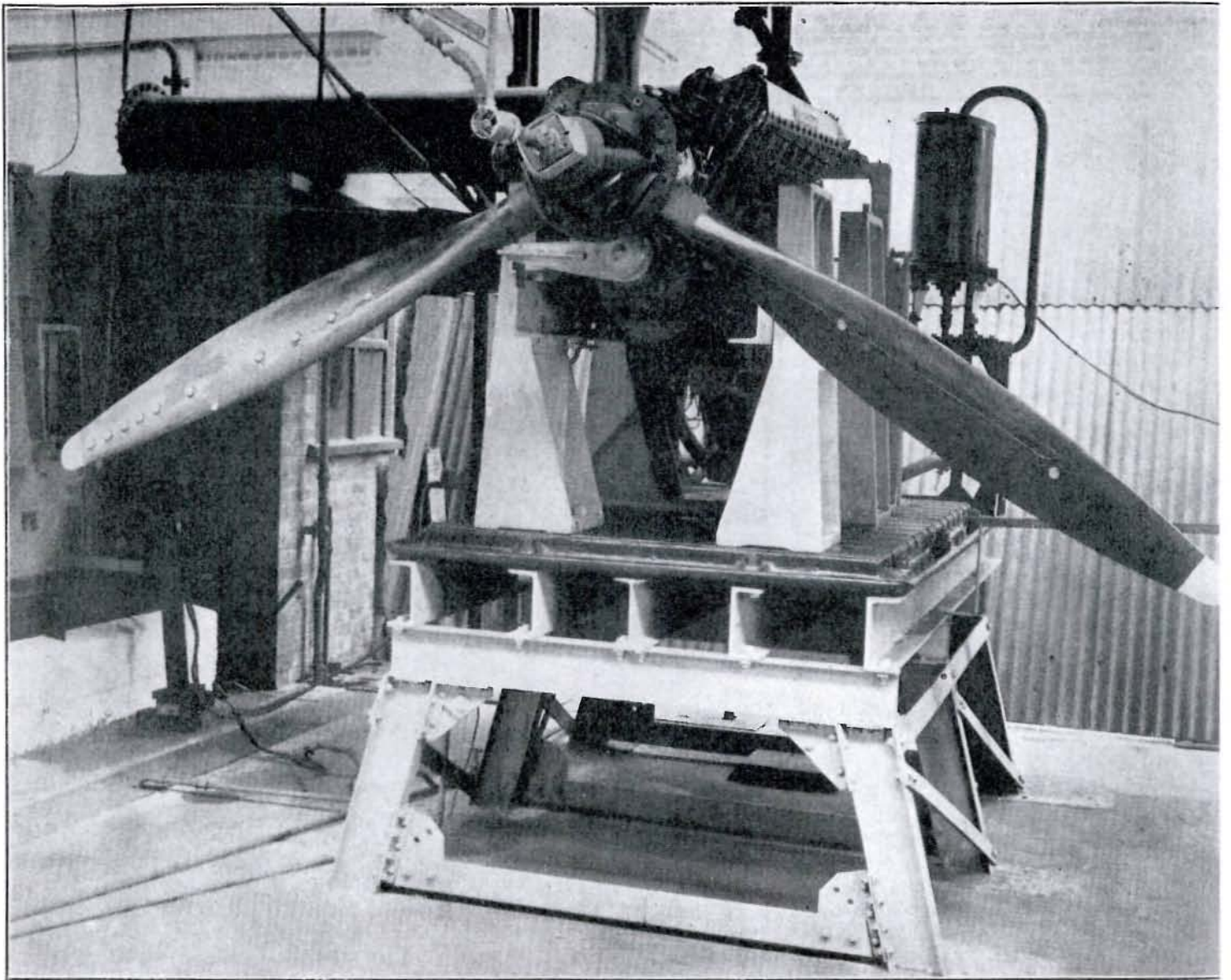

FIG. 1. Hangar test bed installation of Merlin II.

4. *Calibration of Records.*—The D.C. amplifiers of the electronic apparatus permitted the amplitude on the film to be calibrated against capacity change of the tuning circuit in micro-micro-farads. Initial rig tests were made to determine change of capacity in terms of angular movement between the gripping points of the pick-up unit. From the above two calibrations and the calculated stiffness of the portion of the pinion-driving shaft straddled by the instrument, an overall calibration of amplitude on the record against torque in the shaft was obtained.

5. *Torque-Oscillation in the Pinion-Driving Shaft.*—In Tables 1 to 5 are shown the results of analysing the records into their constituent harmonic components. To enable these to be plotted about corresponding mean torque values, mean torques were calculated from the boost pressure by using performance data given in Ref. 2. For speeds below 2,000 r.p.m., extrapolations were made by taking (for the points obtained) the mean value of the constant  $C$  in the relationship:  $B.H.P. = CN^3$ , where  $N$  is the crankshaft speed.

In Figs. 2 to 6, the harmonic components of the torque in the pinion-driving shaft are shown plotted about the mean-torque curve for the several blade angles concerned: the marked effect of blade pitch is apparent.

In Fig. 7, the resonances shown in Figs. 2 to 6 are plotted on a base of blade angle: the radii of the circles indicate the amplitudes of the harmonic torques and the numbers on the circumferences the orders of the vibration. The curves  $A$  to  $E$  group the main resonances into distinctive modes of the complex system.

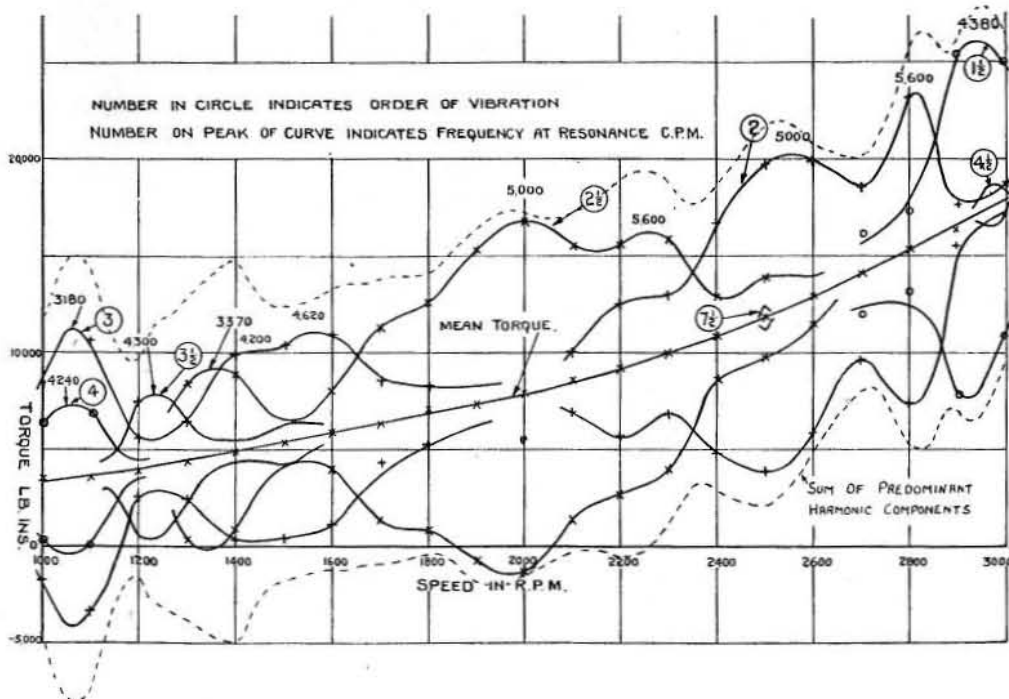

FIG. 2.—Predominant harmonic components of torsional vibration. Blade angle  $16.5^\circ$ .

## MERLIN II.

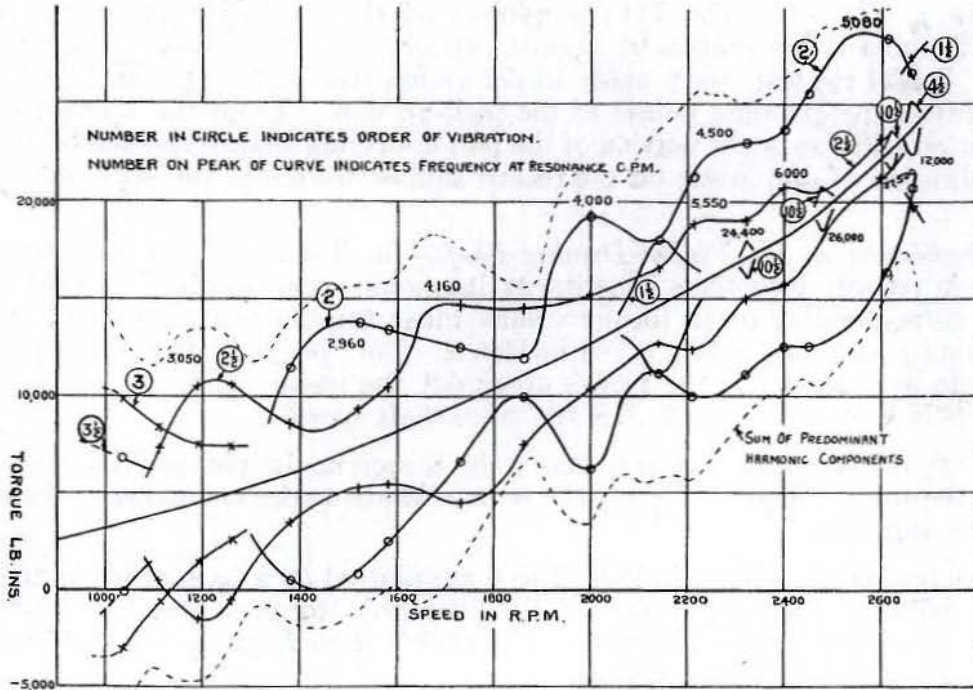

FIG. 3.—Predominant harmonic components of torsional vibration. Blade angle  $20.5^\circ$ .  
 MERLIN II.

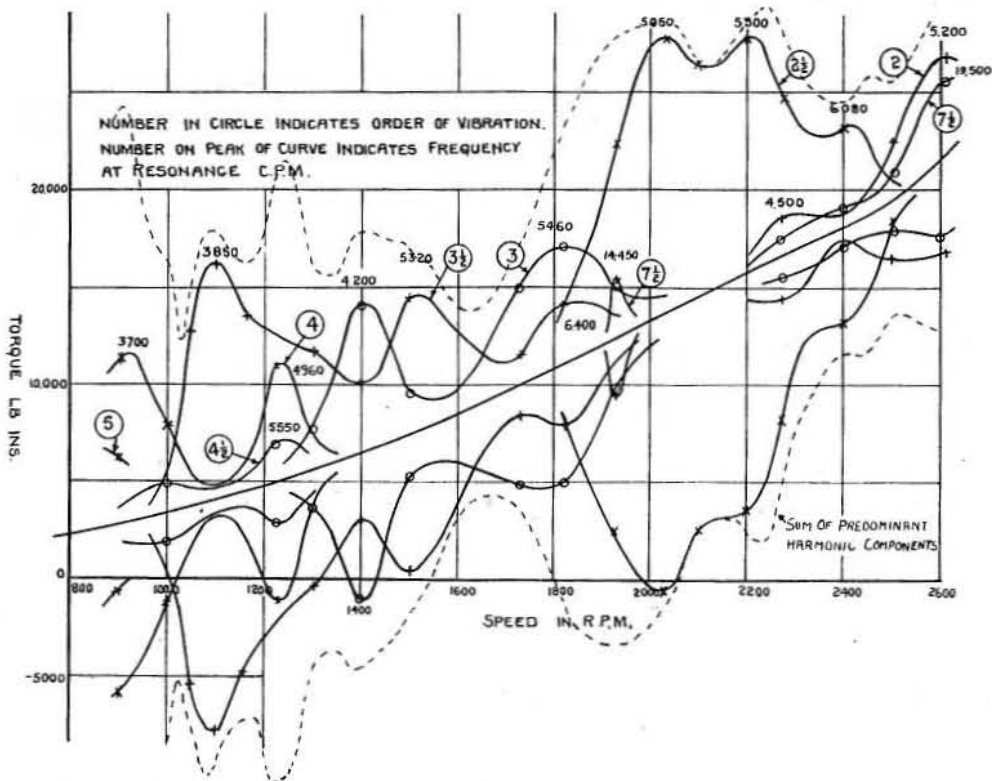

FIG. 4.—Predominant harmonic components of torsional vibration. Blade angle  $22.5^\circ$ .  
 MERLIN II.

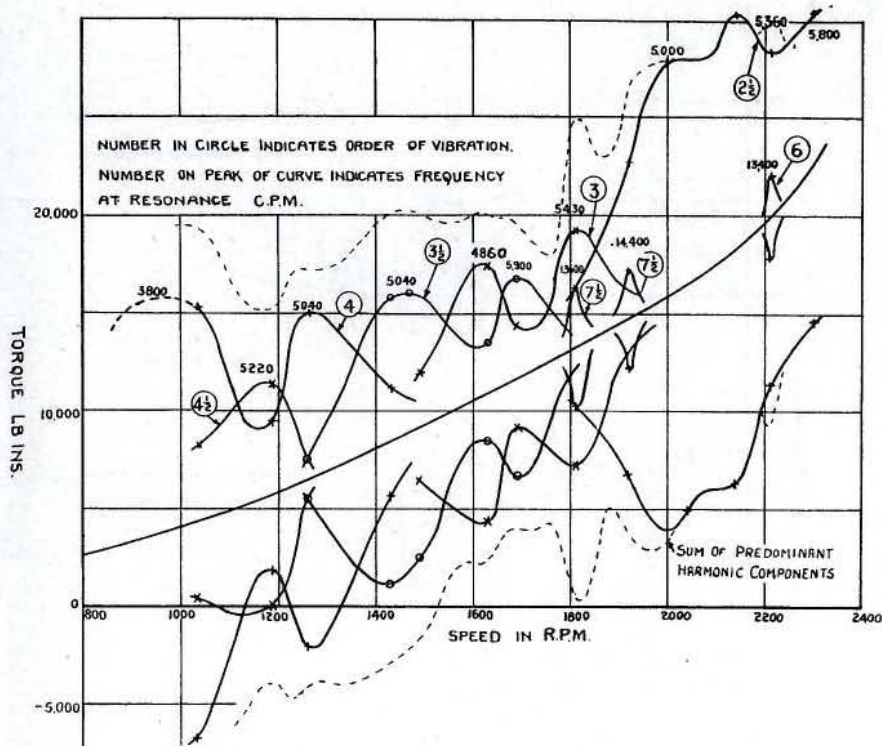

FIG. 5.—Predominant harmonic components of torsional vibration. Blade angle 25.5°.

MERLIN II.

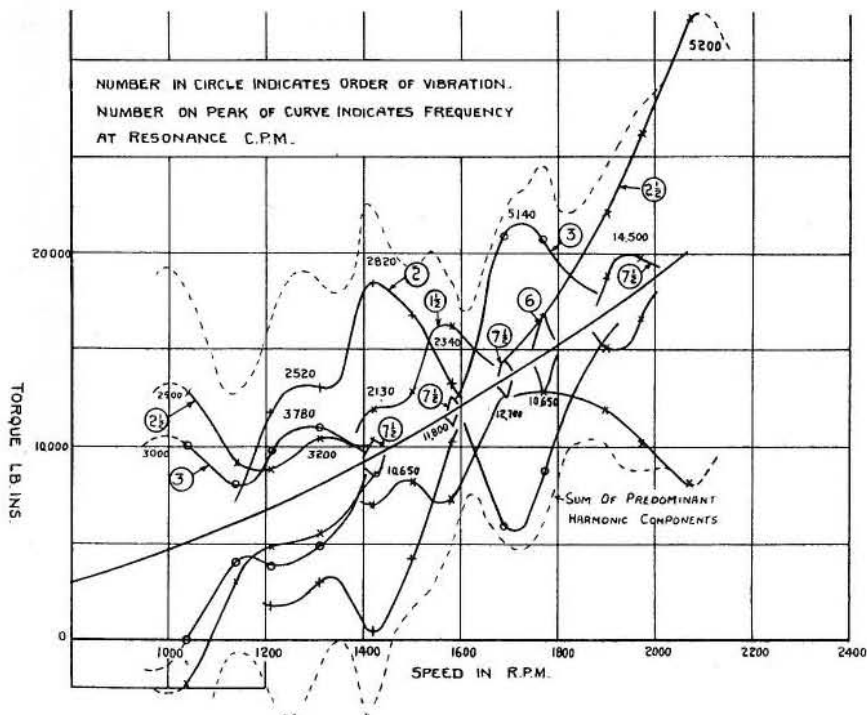

FIG. 6.—Predominant harmonic components of torsional vibration. Blade angle 29°.

MERLIN II.



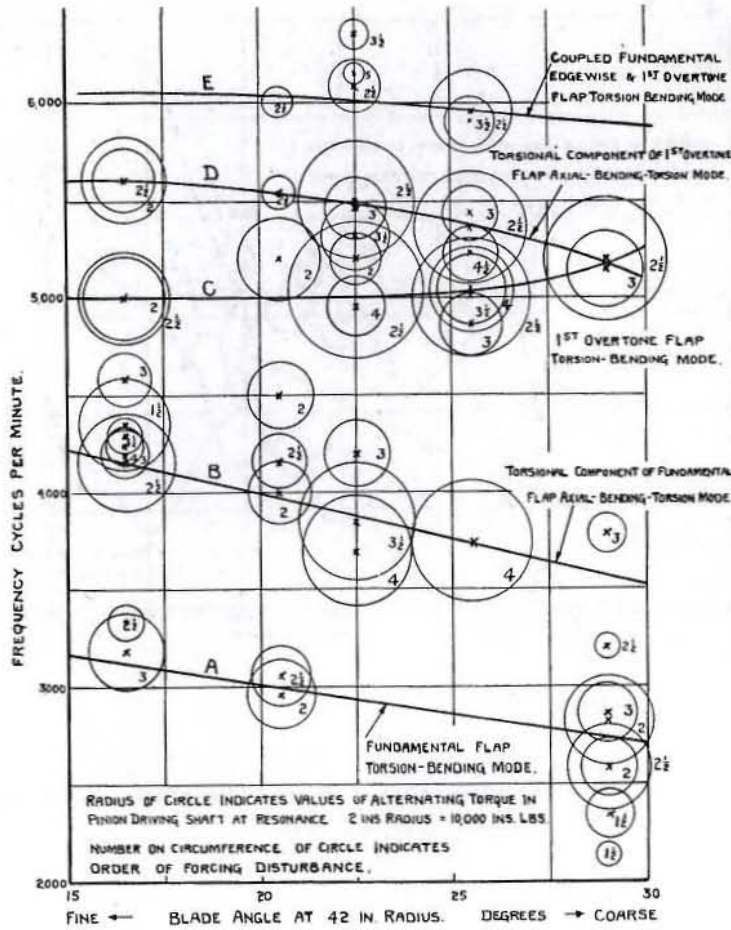

FIG. 7.—Resonant conditions of engine airscrew system plotted against blade angle based on torsion measurements in pinion driving shaft of Merlin II.

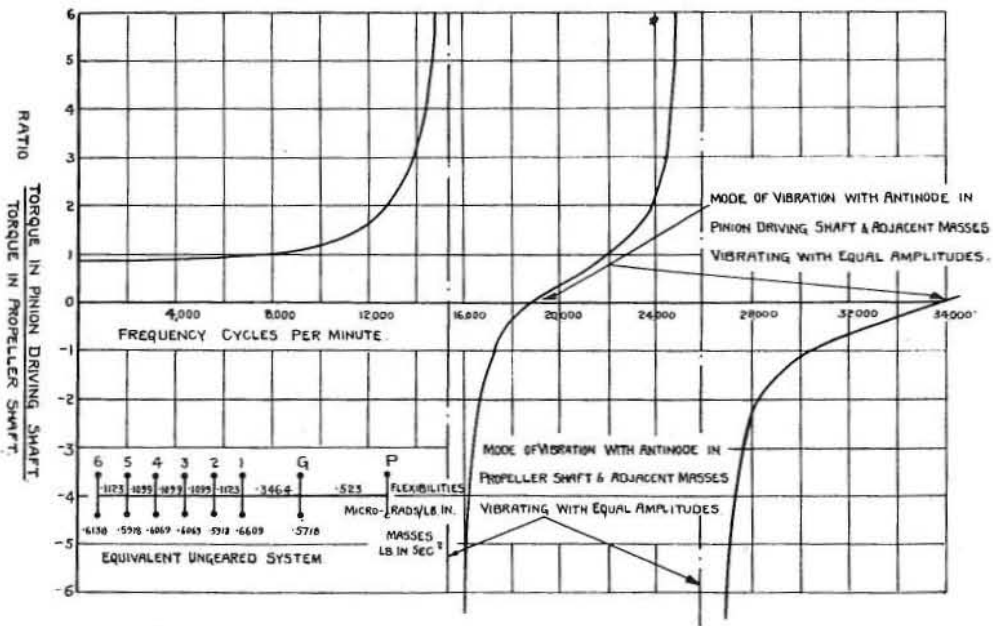

FIG. 8.—Ratio  $\frac{\text{torque in pinion driving shaft}}{\text{torque in propeller shaft}}$  in equivalent ungeared system plotted against frequency for Merlin II.



6. *Distribution of Harmonic Torque in the System.*—When interpreting the results, it should be borne in mind that the distribution of harmonic torque in the shaft system cannot be fully determined over the frequency range from measurements taken at one place in the system. For example, the ratio of the torque in the pinion-driving shaft to that in the propeller shaft varies according to the mode of vibration and therefore varies with frequency. Values of this ratio are plotted in Fig. 8, which shows the equivalent ungeared crankshaft-propeller-shaft system. These values were obtained by working out the Lewis Table for a number of frequencies, taking an arbitrary angular amplitude of oscillation at the tail end of the shaft. At 18,800 and 34,100 c.p.m., the ratio is zero because the harmonic torque in the pinion-driving shaft is zero. At these frequencies there is an antinode at the measuring point with adjacent masses vibrating with equal amplitude—so that the torsigraph records zero harmonic torque regardless of the severity of the vibration: there is, in effect, a “blind spot” in the records for these particular frequencies.

At 15,300 and 25,800 c.p.m., the ratio is infinite because the harmonic torque in the propeller shaft is zero.

For a general torsional vibration investigation, observations require to be made at two points in the system or, alternatively with two types of torsigraph at the same point. Below 9,000 c.p.m., which is the region of main interest in the present investigation, the ratio does not differ widely from unity.

It should be noted that a floating-flywheel type of torsigraph has a “blind spot” when there is a *node* at the measuring point—not an *antinode*.

7. *Discussion of Results.*—Modes of vibration represented by curves *A*, *C*, and *E*, in Fig. 7 are recognised from previous knowledge of the propeller characteristics to be as follows:—

- A. Fundamental “flapping” of the propeller blades with a single torsional node in the shaft.
- C. First overtone “flapping” of the propeller blades with a single torsional node in the shaft.
- E. Coupled fundamental edgewise blade vibration and first overtone “flapping” with a single torsional node in the shaft.

The criticals corresponding to curves *B* and *D* cannot be reconciled with the accepted torsion-bending theory\* nor with coupling of torsion in the blades with bending. An explanation of these modes must be sought because the behaviour of the torsigraph on this and other engines has given confidence that it records the torque oscillation in the shaft with good accuracy, that it is unaffected by lateral oscillation of the pinion-driving shaft, and that it does not give erroneous readings. This confidence has been supported by subjecting the instrument to transverse vibrations of 0.002 inch amplitude on a vibrating table at frequencies from 0 to 10,000 c.p.m. and by a number of check calibrations made in the course of the experiments.

At one stage in the experiments, it was thought that the torsigraph had been set towards the limit of its range of linearity but, on stripping and re-assembling the instrument twice, the records repeated themselves each time: the apparent distortion of the records was found to be due to reversal of torque in the drive under conditions of small transmitted torque. The torque oscillations analysed in this report are, in general, the mean of three sets of observations.

7.1. *Main Modes of Vibration of an Engine-Propeller System.*—An engine-propeller system can vibrate in the following main modes:—

- (a) Torsional vibration of the shaft system coupled with bending vibrations of the propeller blades.

\* Torsional vibration of the shaft system associated with flexural vibrations of the propeller blades, the thrust race being rigidly anchored.

- (b) Whirling vibration of the engine on its supports coupled with bending vibrations of the propeller blades. The whirling vibration of the engine may be elliptic and it includes transverse and vertical vibration of the centre of gravity of the system and angular vibration about transverse and vertical axes.
- (c) Angular vibration of the engine about a longitudinal axis coupled, in geared engines only, with torsional vibration in the shaft system and bending vibrations of the propeller blades.
- (d) Axial vibration of the engine and/or shaft masses coupled with bending vibrations of the propeller blades.

Commenting upon these in turn :

- (a) This is the type of vibration to which most attention has been given hitherto, usually with the assumption that it suffices to replace a geared shafting by an "equivalent" ungeared system: that is to say, the engine body is taken to be infinitely rigid and to be of infinite inertia.

The resonance frequencies of the predominately torsion-bending modes represented by curves *A*, *C*, and *E*, of Fig. 7, have been plotted in Fig. 9 on the (calculated) single-node curves of crankshaft-frequency against "admittance" at the propeller hub, and the approximate admittance curves for the propeller inferred in this way are shown chain-dotted.

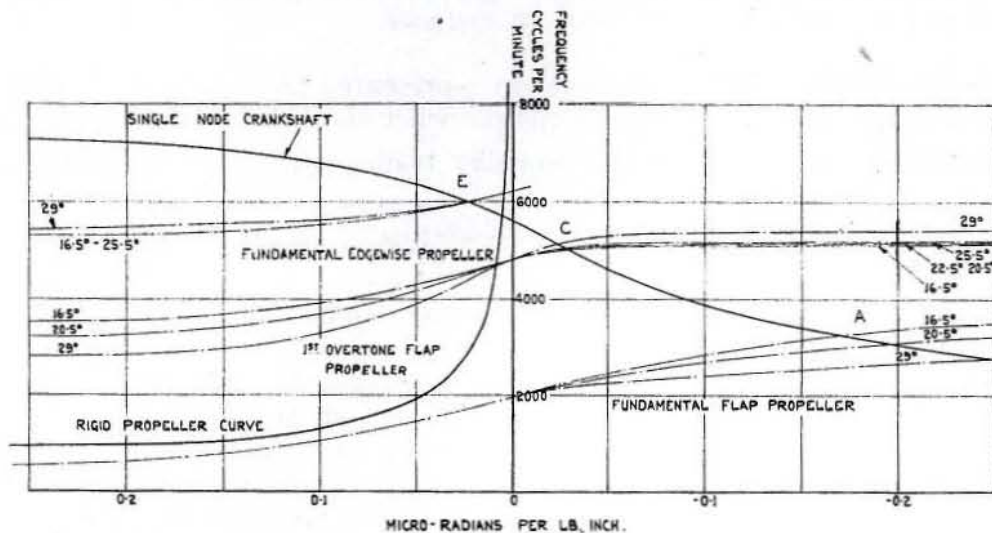

FIG. 9.—Admittance curves for torsion-bending mode of propeller drawn for point at root of blade.

Fig. 7 shows the resonance frequencies falling with increase of blade angle. For curve *C*, the frequency is little affected by blade angle, the greatest effect being a slight increase at large blade angles. The constant frequency is practically the frequency for fixed-root first-overtone "flapping" vibration of the propeller blades.

The fall of resonance frequency with increase of blade angle is inconsistent with pure fundamental torsion-bending and is doubtless associated with the coupling with the mode examined under heading (d).

- (b) Whirling oscillation of the engine is coupled with flexural modes of vibration of the blades but, in a symmetrical system, the aerodynamic and inertia forces and couples associated with whirling can produce no resultant torque about the shaft axis and thereby excite any torsional response in the shaft masses. In an actual system, irregularities of the blades might result in such torsional excitation but the magnitude would be negligible.

(c) The mode of vibration described in (c) above is analysed in the latter part of Part II of Ref. 3 but for epicyclic systems only. Examination of the matter on this basis gives a small value for the coupling effect associated with torsional yielding of the gear case and/or engine body. Den Hartog & Butterfield published an article<sup>4</sup> in which an example was given showing a large effect but in correspondence with Professor Den Hartog at the time he agreed that the assumptions upon which the example was based do not represent normal practice.

Observations made with a vibrograph fitted off-centre on the reduction gear housing showed a resonant vibration of 1st crankshaft order at 2,000 r.p.m. but the general evidence was that this coupling can be ignored in the present instance.

(d) Here coupling action between modes (d) and (a) is brought about by the propeller blade inclination at all blade-pitch angles. This coupling action has been disregarded hitherto although a number of instances have occurred during the strain-gauge measurement of criticals where the observations could not be reconciled as coming under mode (a).

The appearance of the two unexpected criticals *B* and *D* can be accounted for on the basis that freedom for axial movement splits into two modes both the fundamental and the first overtone modes of flexural blade vibration in "flap". Fig. 7 shows that the frequency for modes *B* and *D* decreased with increase of pitch angle.

The matter of axial vibration and coupling with the torsional modes will now be examined in some detail.

8. *Axial-Vibration Measurements.*—Measurements of axial vibration were made by bolting an R.A.E. vibrograph to the generator flange on the engine. The results of analysing the records taken are given in Table 6. This analysis was difficult because of the smallness of the amplitudes and to the fact that a large number of harmonics was present but nearly all the resonances observed in the torsional system are present in some degree in the axial-vibration records.

Curves *B* and *D* of Fig. 7 give the frequencies 3,850 and 5,470 c.p.m., respectively, for a blade-pitch angle of 23 deg. at which angle the vibrograph records were taken. From Table 6 it will be seen that the axial vibrations corresponding to these two frequencies are as follow :—

Forcing frequency : 4th engine order at approximately 1,000 r.p.m.

Vibration frequency = 3,950 c.p.m.  
amplitude = 0.0006 inch.

Forcing frequency :  $3\frac{1}{2}$  engine order at approximately 1,500 r.p.m.

Vibration frequency = 5,300 c.p.m.  
amplitude = 0.001 inch.

Forcing frequency :  $2\frac{1}{2}$  engine order at approximately 2,200 r.p.m.

Vibration frequency = 5,600 c.p.m.  
amplitude = 0.0012 inch.

8.1. *Mathematical Examination of the Vibration of a Simplified System Involving Axial Vibration.*—In the Appendix, an expression is derived for the natural frequencies of a simplified system having three masses, representing a shaft and propeller, attached to a mass which is free to vibrate axially. The values of the masses and stiffnesses have been chosen to represent the experimental system as regards low-frequency modes.

The effect of the axial system at various blade-pitch settings is shown in Fig. 11 by the splitting of the curve *a,b,c,d* into the two branches *k,c,d* and *a,b,j*.

Another mode of vibration is introduced by the axial coupling (represented by  $k,c$  and  $b,j$ ) and the low-frequency mode (that is, the mode mainly influenced by the flexing of the propeller blades) has its frequency lowered at pitch angles beyond 20 deg. as represented by the change from curve  $a,b,c,d$  to curve  $a,b,j$ .

Thus when there is an axial system having a natural frequency of vibration relative to the main system of about the same frequency as that of the system alone in fundamental torsion-bending, another mode of vibration will be found in the torsional system and the fundamental torsion-bending frequency will be lower than the value with the thrust race rigidly held or with the natural frequency of the axial system itself remote from the fundamental torsion-bending frequency.

The existence of curve  $B$  of Fig. 7 is thus explained and the existence of curve  $D$  is explainable in the same general manner; however, the theory given in the Appendix does not explain the falling off of frequency with increase of pitch angle, presumably because the system is oversimplified.

9. *Vibration Excited by Teeth of Gearing.*—Throughout the records, a 21st order vibration was present, i.e. one impulse per tooth engagement. This cannot be a resonance of the recording instrument or equipment because it appears at all speeds. A small 21st order resonance occurs at 2,200 r.p.m. for blade pitch angle of 20.5 deg. of amplitude 1,000 lb. in. torque in the pinion driving shaft. A 42nd order vibration appears at various speeds with blade angles of 22.5 deg. and 29 deg. A vibration of 105th order appears throughout the records, that is, five vibrations per tooth engagement.

10. *Severity of Component Harmonic Torques Corresponding to the Various Engine Orders.*—The lower orders of the harmonic torques are most important from the point of view of stresses in the pinion driving shaft. Higher orders of  $4\frac{1}{2}$ , 6,  $7\frac{1}{2}$  and  $10\frac{1}{2}$  engine speeds are present but only of small magnitude. The higher orders may be very important from the point of view of propeller vibration by resulting in high stresses near the tip. Any forcing impulses that may be at about 19,000 c.p.m. have not been detected owing to the occurrence at this frequency of an antinode at the location of the torsigraph—so that there is equal amplitude of vibration of adjacent masses.

11. *Conclusions.*—There were three predominant modes of torsion-bending vibration, namely fundamental, first overtone flapping, and a combined fundamental edgewise and 1st overtone flapping of the propeller at 3,150, 5,000 and 6,050 c.p.m. at 15 deg. blade pitch angle respectively. Due to the proximity of the natural frequency in the axial direction to the fundamental and 1st overtone torsion-bending modes, the axial-bending mode of vibration was strongly coupled with these torsion-bending modes, the torsional component of this complex mode of vibration being measured by the torsigraph. The torsional components of these complex modes of vibration were observed to resonate at 4,200 and 5,600 c.p.m. at 15 deg. blade pitch angle.

The resonance frequency of all modes of vibration decreased with increase in blade pitch angle except for the first overtone propeller torsion-bending mode which was almost a fixed root mode of vibration and was almost constant, increasing a little for the high values of the blade pitch angle.

The fall of resonance frequency with increase in blade pitch angle for the fundamental torsion bending mode cannot be explained by the accepted torsion bending theory assuming infinite rigidity of thrust race. This fall of frequency is considered to be due to the coupling of the axial-bending and torsion-bending modes. The coupling produced an important effect because the natural frequencies of the axial system, and the associated forces were of the same order of magnitude as those of the shaft propeller system. The stresses resulting from the torsional component of the axial modes are of the same order of magnitude as those resulting from the torsion bending modes.

From plotting the deflection diagrams for the torsional system it was found that a mode of vibration with an antinode in the pinion driving shaft with adjacent masses vibrating with equal magnitudes occurred at 19,000 and 34,000 c.p.m. No indication of the torsional vibration in the range of these frequencies will be given by a torsigraph placed in the pinion driving shaft and hence for a general vibration investigation of the torsional vibration, readings at two points would be necessary to avoid "blind spots" in the frequency range.

All the torsion bending resonances referred to above are one-noded crankshaft modes. Two-noded crankshaft modes were recorded but were of less than 1,000 lb. in. torque amplitude except for  $7\frac{1}{2}$  order forcing frequency at approximately 2,610 r.p.m. of 19,600 c.p.m. for a blade angle of  $22\cdot\frac{5}{8}$  deg. which gave 4,000 lb. in. torque amplitude. The two-noded mode of vibration may give rise to high stresses in the propeller blades.

Throughout the records a 21st engine order vibration of small magnitude was present which was caused by the teeth engagement, and a 42nd engine order vibration was present on some of the records.

The conclusions reached in the present investigation are in some degree tentative because they are based upon observations at only two points in a highly complex vibrating system.

A more comprehensive investigation would involve simultaneous observations of propeller stress and of translational and angular motion of the hub and of the engine body.

---

#### REFERENCES

| <i>No.</i> | <i>Author</i>                          | <i>Title</i>  |
|------------|--|---|
| 1          | B. C. Carter ; J. R. Forshaw .. ..     | Design and Development of a Torsigraph having a Serrated Condenser Pick-up Unit. R. & M. 1982. 1945.  |
| 2          | The Staff of Eng. Dept. .. ..          | Bench Tests of a Merlin II Under Artificial Altitude Conditions. September, 1939. R.A.E. Report No. 3728. (4792.) (Unpublished.)            |
| 3          | B. C. Carter .. ..                     | Torsional Vibration in Aircraft Power Plants : Methods of Calculation. September, 1937. R.A.E. Report E.3586. (3519.) (Unpublished.)        |
| 4          | J. P. Den Hartog, J. P. Butterfield .. | The Torsional Critical Speeds of Geared Airplane Engines. <i>Journal of the Aeronautical Sciences.</i> October, 1937.                       |
| 5          | J. R. Forshaw .. ..                    | Analysis of Serrated Condenser Torsigraph Records obtained from a Merlin 61 Engine. June, 1942. R.A.E. Tech. Note No. Eng.7. (Unpublished.) |

---

## APPENDIX

*Analysis of the Natural Frequencies of Coupled Axial and Torsional Vibration of Three Single Node Systems Linked Together to Represent the Low Frequency Modes of an Engine-Propeller Combination.*

The engine-propeller system and its mounting is idealised into the three single node systems (shown in Fig. 10) linked through the propeller blades and hub. The hub and propeller shaft are considered infinitely stiff to the thrust race, and the engine is represented by a mass linked with axial flexibility to a mass representing the aircraft. This forms the axial system with the resolved component of the propeller.

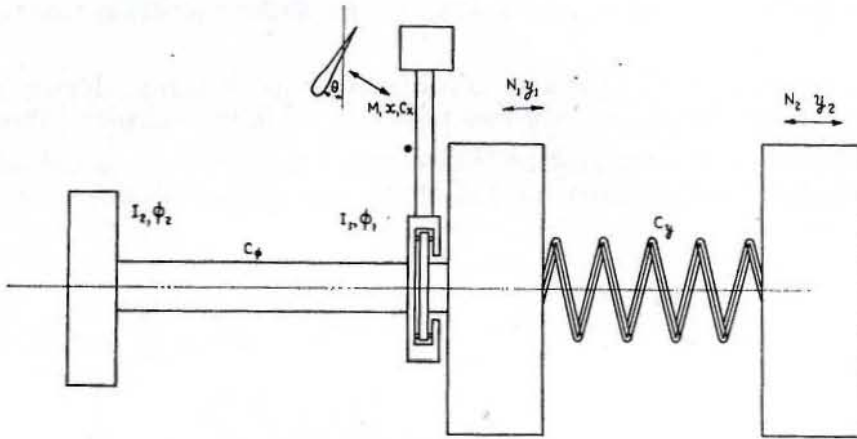

FIG. 10.—Three single node systems connected to represent coupled axial and torsional vibration of engine-propeller system with mounting.

The crankshaft and propeller hub are represented by two masses joined by a member flexible in torsion, and this forms the torsional system with the resolved component of the propeller. The propeller blade is considered as a mass on the end of a cantilever.

Let  $I_1$  represent the polar moment of inertia of the propeller hub.

$I_2$  represent the polar moment of inertia of equivalent engine mass.

$N_1$  represent the mass of the engine.

$N_2$  represent the mass of the aircraft.

$M$  represent the equivalent mass of one propeller blade.

$\phi_1$  represent the angular deflection of the hub.

$\phi_2$  represent the angular deflection of the equivalent crankshaft mass.

$x$  represent the deflection of the propeller blade mass normal to the chord.

$y_1$  represent the axial deflection of engine mass.

$y_2$  represent the axial deflection of aircraft mass.

$R$  represent the distance of the  $C$  of  $G$  of equivalent mass  $M$  from torsional axis.

$\theta$  represent the blade pitch angle.

$C_\phi$  represent the torsional stiffness of the crankshaft.

$C_y$  represent the stiffness between engine and aircraft.

and  $C_x$  represent the stiffness of the propeller blades normal to the chord.

The stiffness of the propeller blade along the chord will be taken to be infinite.

Equations of motion in axial direction :—

$$N_1 \frac{d^2 y_1}{dt^2} + C_y (y_1 - y_2) - 3C_x (x - R\phi_1 \sin \theta - y_1 \cos \theta) \cos \theta = 0$$

$$N_2 \frac{d^2 y_2}{dt^2} + C_y (y_2 - y_1) = 0$$

Equations of motion about torsional axis :—

$$I_1 \frac{d^2 \phi_1}{dt^2} + C_\phi (\phi_1 - \phi_2) - 3RC_x (x - R\phi_1 \cos \theta - y_1 \cos \theta) \sin \theta = 0$$

$$I_2 \frac{d^2 \phi_2}{dt^2} + C_\phi (\phi_2 - \phi_1) = 0$$

Equation of motion normal to chord of propeller.

$$M \frac{d^2 x}{dt^2} + C_x (x - R\phi_1 \sin \theta - y_1 \cos \theta) = 0$$

Solving above equations, the frequency equation may be expressed in the following form, which is convenient for plotting :

$$\sin^2 \theta = \frac{w^6 - Xw^4 + Yw^2 + Z}{Sw^4 - Tw^2 + U}$$

where

$$X = 3C_x \left( \frac{1}{3M} + \frac{1}{N_1} \right) + C_y \left( \frac{1}{N_1} + \frac{1}{N_2} \right) + C_\phi \left( \frac{1}{I_1} + \frac{1}{I_2} \right)$$

$$Y = C_x C_y \left\{ \frac{1}{3M} \left( \frac{1}{N_1} + \frac{1}{N_2} \right) + \frac{1}{N_1 N_2} \right\} + 3C_x C_\phi \left( \frac{1}{3M} + \frac{1}{N_1} \right) \left( \frac{1}{I_1} + \frac{1}{I_2} \right) + C_y C_\phi \left( \frac{1}{N_1} + \frac{1}{N_2} \right) \left( \frac{1}{I_1} + \frac{1}{I_2} \right)$$

$$Z = 3C_x C_y C_\phi \left[ \frac{1}{3M} \left( \frac{1}{N_1} + \frac{1}{N_2} \right) + \frac{1}{N_1 N_2} \right] \left( \frac{1}{I_1} + \frac{1}{I_2} \right)$$

$$S = 3C_x \left( \frac{R^2}{I_1} + \frac{1}{N_1} \right)$$

$$T = 3C_x C_y \left\{ \frac{R^2}{I_1} \left( \frac{1}{N_1} + \frac{1}{N_2} \right) - \frac{1}{N_1 N_2} \right\} - 3C_x C_\phi \left\{ \frac{1}{N_1} \left( \frac{1}{I_1} + \frac{1}{I_2} \right) - \frac{R^2}{I_1 I_2} \right\}$$

$$U = 3C_x C_y C_\phi \left\{ \frac{R^2}{I_1 I_2} \left( \frac{1}{N_1} + \frac{1}{N_2} \right) - \frac{1}{N_1 N_2} \left( \frac{1}{I_1} + \frac{1}{I_2} \right) \right\}$$

To approximate to the conditions holding in the experiment, take:  $I_1 = 20 \text{ lb. in. sec.}^2$ .  
 $I_2 = 22 \text{ lb. in. sec.}^2$ .

$$N_1 = \frac{1400}{32.2 \times 12} = 3.623 \text{ lb. sec.}^2/\text{in.}$$

$$N_2 = \frac{5000}{32.2 \times 12} = 12.94 \text{ lb. sec.}^2/\text{in.}$$

$$M = \frac{80}{32.2 \times 12} = 0.207 \text{ lb. sec.}^2/\text{in.}$$

Natural frequency of substitute crankshaft with node at hub of propeller 5,600 cycles per min.

$$C\phi \text{ becomes } I_2 \frac{5600^2 4\pi^2}{60^2} = 7.56 \times 10^6 \text{ lb.in./radian.}$$

Natural frequency of substitute engine and airframe system with no propeller 4,500 c.p.m.

$$C_y \text{ becomes } \frac{N_1 N_2}{N_1 + N_2} \frac{4500^2 4\pi^2}{60^2} = 0.634 \times 10^6 \text{ lb./in.}$$

and natural frequency of substitute propeller blade with node at root 1,875 c.p.m.

$$C_x \text{ becomes } M \frac{1875^2 4\pi^2}{60^2} = 0.01 \times 10^6 \text{ lb./in.}$$

The above expression was plotted giving the curves *a,b,j*; *k,c,d* and *e,f,g,h* of Fig. 11.

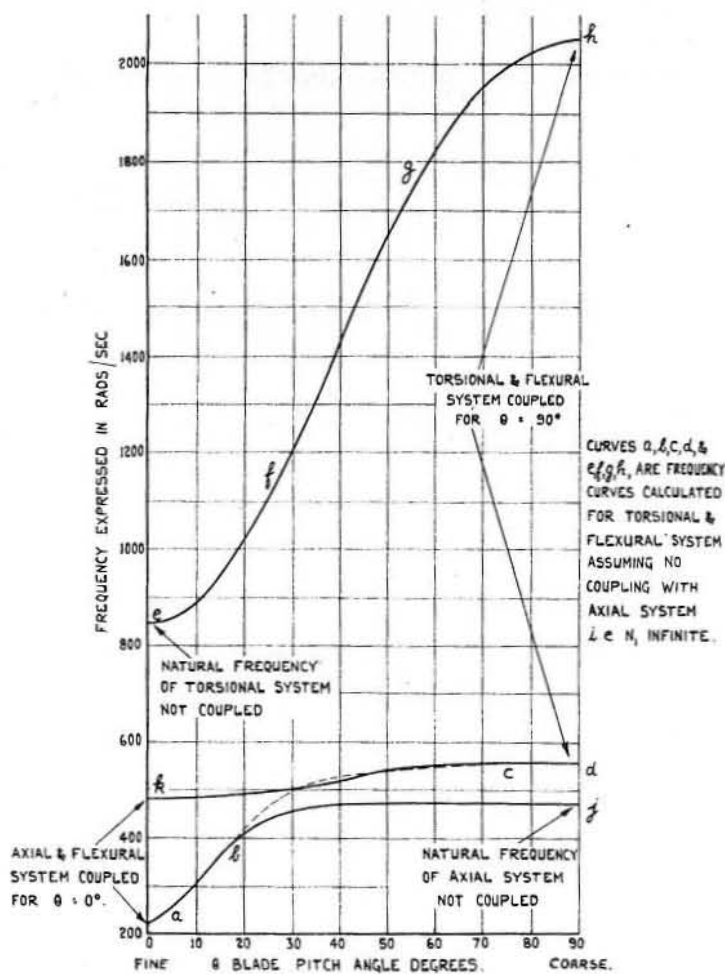

FIG. 11.—Curves of natural frequency of simplified system assuming propeller blade to be infinitely rigid along chord.



In order to find the effect of the axial system on the coupled system mass  $N_1$  was assumed to be infinite.

The frequency equation is then :—

$$\omega^4 - \omega^2 \left\{ 3C_x \left( \frac{1}{3M} + \frac{R^2}{I_1} \right) + C_\phi \left( \frac{1}{I_1} + \frac{1}{I_2} \right) \right\} + 3C_x C_\phi \left( \frac{1}{3MI_1} + \frac{1}{3MI_2} + \frac{R^2}{I_1 I_2} \right) = 0$$

The above numerical values have been substituted in this expression and the resulting frequency curves are *a, b, c, d* and *e, f, g, h* in Fig. 11. The difference in the two systems occurs in the region *b, e*, which for the axial system coupled splits into two branches *b, c* and *b, j*.

The influence of the axial system extends over a small range of frequency in the region of the natural frequency of the axial system. In Fig. 12 the frequency curves have been plotted for a similar system to one previously plotted but with the inertia and torsional stiffness  $\frac{1}{4}$  of previous values. In this case, the resulting frequencies are widely separated and the difference in the torsional resonances due to the axial coupling, cannot be detected.

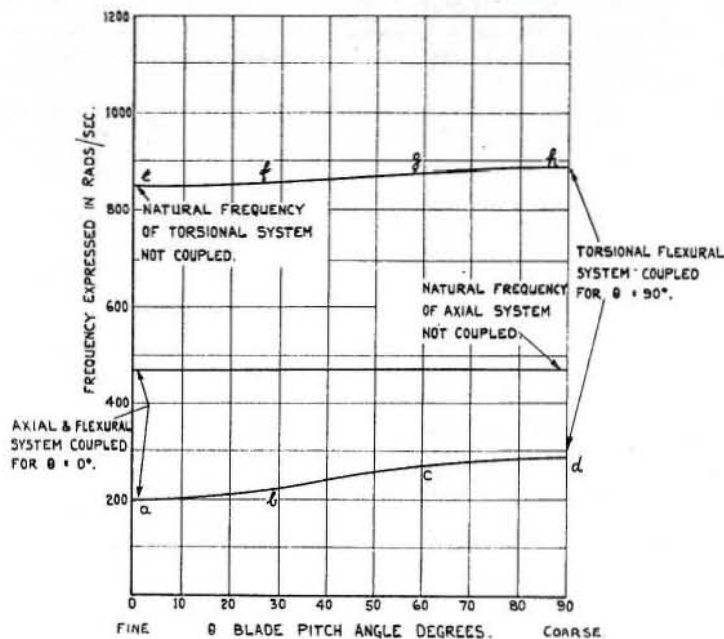

FIG. 12.—Curves of natural frequency of simplified system, assuming propeller blade to be infinitely rigid along chord values of moments of inertia  $\frac{1}{4}$  of those taken for Fig. 10, but torsional frequency, axial and flexural conditions the same.

Curves *a, b, c, d* and *e, f, g, h* are frequency curves calculated for torsional and flexural system, assuming no coupling with axial system, i.e.  $N_1$  infinite.

TABLE 1  
*Harmonic Analysis of Torsiograph Records*  
*Blade Angle 16°-50'*

| Engine R.P.M. | Frequency Cycles Per Min. | Order | Amplitude, Lb. In. | Engine R.P.M. | Frequency Cycles Per Min. | Order | Amplitude Lb. In. |
|---------------|---------------------------|-------|--------------------|---------------|---------------------------|-------|-------------------|
| 1,000         | 3,000                     | 3     | 5,000              | 2,000         | 5,000                     | 2½    | 9,000             |
|               | 4,000                     | 4     | 3,000              |               | 21,000                    | 10½   | 500               |
|               | 21,000                    | 21    | 300                | 2,100         | 5,250                     | 2½    | 7,000             |
| 1,100         | 3,300                     | 3     | 7,000              |               | 4,200                     | 2     | 1,500             |
|               | 4,400                     | 4     | 3,500              | 2,200         | 5,500                     | 2½    | 6,500             |
|               | 23,100                    | 21    | 400                |               | 4,400                     | 2     | 3,500             |
| 1,200         | 4,200                     | 3½    | 3,500              | 2,300         | 5,750                     | 2½    | 6,000             |
|               | 3,600                     | 3     | 1,500              |               | 4,600                     | 2     | 3,000             |
|               | 25,200                    | 21    | 400                | 2,400         | 6,000                     | 2½    | 2,500             |
| 1,300         | 4,550                     | 3½    | 2,000              |               | 4,800                     | 2     | 6,000             |
|               | 3,900                     | 3     | 2,000              |               | 50,400                    | 21    | 800               |
|               | 3,250                     | 2½    | 4,000              | 2,500         | 6,250                     | 2½    | 2,000             |
|               | 27,300                    | 21    | 500                |               | 5,000                     | 2     | 8,000             |
| 1,400         | 4,200                     | 3     | 5,000              |               | 18,750                    | 7½    | 600               |
|               | 3,500                     | 2½    | 4,000              |               | 52,500                    | 21    | 500               |
|               | 29,400                    | 21    | 500                | 2,600         | 6,500                     | 2½    | 1,000             |
| 1,500         | 5,250                     | 3½    | 1,000              |               | 5,200                     | 2     | 7,000             |
|               | 4,500                     | 3     | 5,000              | 2,700         | 5,400                     | 2     | 4,000             |
|               | 31,500                    | 21    | 500                |               | 4,050                     | 1½    | 2,000             |
| 1,600         | 4,800                     | 3     | 5,000              | 2,800         | 5,600                     | 2     | 8,000             |
|               | 4,000                     | 2½    | 2,000              |               | 4,200                     | 1½    | 2,000             |
|               | 33,600                    | 21    | 400                |               | 29,400                    | 10½   | 600               |
| 1,700         | 5,100                     | 3     | 2,000              | 2,900         | 5,800                     | 2     | 1,000             |
|               | 4,250                     | 2½    | 5,000              |               | 4,350                     | 1½    | 9,000             |
|               | 35,700                    | 21    | 400                |               | 13,050                    | 4½    | 600               |
| 1,800         | 5,400                     | 3     | 1,500              | 3,000         | 6,000                     | 2     | 1,000             |
|               | 4,500                     | 2½    | 6,000              |               | 4,500                     | 1½    | 7,000             |
|               | 37,800                    | 21    | 500                |               | 13,500                    | 4½    | 800               |
| 1,900         | 5,700                     | 3     | 8,000              |               |                           |       |                   |
|               | 4,750                     | 2½    | 1,500              |               |                           |       |                   |
|               | 39,900                    | 21    | 500                |               |                           |       |                   |

Amplitude is Half Range

TABLE 2  
*Harmonic Analysis of Torsiograph Records*  
*Blade Angle 20°-50'*

| Engine R.P.M. | Frequency Cycles Per Min. | Order | Amplitude Lb. In. | Engine R.P.M. | Frequency Cycles Per Min. | Order | Amplitude Lb. In. |
|---------------|---------------------------|-------|-------------------|---------------|---------------------------|-------|-------------------|
| 1,035         | 3,105                     | 3     | 6,500             | 2,000         | 4,000                     | 2     | 6,500             |
|               | 3,620                     | 3½    | 3,500             |               | 5,000                     | 2½    | 2,500             |
|               | 21,750                    | 21    | Trace             |               | 42,000                    | 21    | 600               |
| 1,110         | 2,780                     | 2½    | 3,500             | 2,140         | 3,210                     | 1½    | 3,500             |
|               | 3,330                     | 3     | 4,500             |               | 4,280                     | 2     | 3,500             |
|               | 23,300                    | 21    | Trace             |               | 5,350                     | 2½    | 2,000             |
| 1,190         | 2,980                     | 2½    | 6,000             |               | 45,000                    | 21    | 600               |
|               | 3,570                     | 3     | 3,000             | 2,210         | 4,420                     | 2     | 5,750             |
|               | 25,000                    | 21    | Trace             |               | 5,520                     | 2½    | 3,250             |
| 1,260         | 3,150                     | 2½    | 5,500             |               | 46,500                    | 21    | 1,000             |
|               | 3,780                     | 3     | 2,500             | 2,320         | 4,640                     | 2     | 6,000             |
|               | 26,400                    | 21    | Trace             |               | 5,800                     | 2½    | 2,000             |
| 1,380         | 2,760                     | 2     | 5,500             |               | 24,400                    | 10½   | 1,000             |
|               | 3,450                     | 2½    | 2,500             |               | 48,800                    | 21    | 300               |
|               | 29,000                    | 21    | Trace             | 2,400         | 4,800                     | 2     | 5,500             |
| 1,520         | 3,040                     | 2     | 6,500             |               | 6,000                     | 2½    | 2,500             |
|               | 3,800                     | 2½    | 2,000             |               | 50,400                    | 21    | 800               |
|               | 31,900                    | 21    | Trace             | 2,470         | 4,940                     | 2     | 6,500             |
| 1,580         | 3,160                     | 2     | 5,500             |               | 7,410                     | 3     | 2,500             |
|               | 3,950                     | 2½    | 2,500             |               | 25,900                    | 10½   | 800               |
|               | 33,200                    | 21    | 400               |               | 51,800                    | 21    | 800               |
| 1,730         | 3,460                     | 2     | 3,000             | 2,610         | 5,220                     | 2     | 6,000             |
|               | 4,320                     | 2½    | 5,000             |               | 6,530                     | 2½    | 1,000             |
|               | 36,300                    | 21    | 500               |               | 27,400                    | 10½   | 1,000             |
| 1,860         | 3,720                     | 2     | 1,000             |               | 54,800                    | 21    | 800               |
|               | 4,650                     | 2½    | 3,500             | 2,700         | 4,050                     | 1½    | 3,500             |
|               | 39,000                    | 21    | Trace             |               | 5,400                     | 2     | 3,000             |
|               |                           |       |                   |               | 12,150                    | 4½    | 1,400             |

Amplitude is Half Range.

*Harmonic Analysis of Torsigraph Records  
Blade Angle 22°-50'*

TABLE 3

| Engine R.P.M. | Frequency Cycles Per Min. | Order | Amplitude Lb. In. | Engine R.P.M. | Frequency Cycles Per Min. | Order | Amplitude Lb. In. |
|---------------|---------------------------|-------|-------------------|---------------|---------------------------|-------|-------------------|
| 900           | 3,600                     | 4     | 8,500             | 1,930         | 4,820                     | 2½    | 1,000             |
|               | 4,500                     | 5     | 3,500             |               | 5,790                     | 3     | 2,500             |
| 1,040         | 4,160                     | 4     | 4,500             |               | 14,450                    | 7½    | 3,000             |
|               | 4,680                     | 4½    | 1,500             |               | 81,000                    | 42    | 800               |
|               | 43,600                    | 42    | 400               |               | 203,000                   | 105   | Trace             |
| 1,100         | 3,850                     | 3½    | 12,000            | 2,000         | 5,000                     | 2½    | 14,000            |
| 1,150         | 4,020                     | 3½    | 9,000             |               | 150,000                   | 75    | 200               |
| 1,225         | 4,900                     | 4     | 6,000             | 2,100         | 5,250                     | 2½    | 12,000            |
|               | 5,520                     | 4½    | 2,000             | 2,200         | 5,500                     | 2½    | 12,000            |
|               | 25,700                    | 21    | Trace             |               | 16,500                    | 7½    | 300               |
| 1,300         | 3,900                     | 3     | 2,000             |               | 158,000                   |       | 100               |
|               | 4,550                     | 3½    | 6,000             | 2,270         | 4,540                     | 2     | 3,000             |
| 1,400         | 4,200                     | 3     | 7,500             |               | 5,680                     | 2½    | 8,000             |
|               | 4,900                     | 3½    | 3,500             |               | 17,000                    | 7½    | 1,000             |
|               | 58,800                    | 42    | 900               |               | 47,600                    | 21    | 1,000             |
| 1,500         | 4,500                     | 3     | 2,000             | 2,400         | 6,000                     | 2½    | 5,000             |
|               | 5,250                     | 3½    | 7,000             |               | 18,000                    | 7½    | 1,000             |
|               | 31,500                    | 21    | 500               |               | 50,400                    | 21    | 1,500             |
|               | 63,000                    | 42    | Trace             | 2,500         | 5,000                     | 2     | 3,000             |
| 1,730         | 4,320                     | 2½    | 1,500             |               | 6,250                     | 2½    | 1,000             |
|               | 5,190                     | 3     | 5,000             |               | 18,750                    | 7½    | 1,500             |
|               | 6,060                     | 3½    | 1,500             |               | 52,500                    | 21    | 1,000             |
|               | 36,300                    | 21    | 600               | 2,610         | 5,220                     | 2     | 5,000             |
| 1,820         | 5,460                     | 3     | 6,000             |               | 19,600                    | 7½    | 4,000             |
|               | 6,370                     | 3½    | 3,000             |               | 54,800                    | 21    | 400               |
|               | 38,200                    | 21    | 1,200             |               |                           |       |                   |

Amplitude is Half Range.

TABLE 4  
*Harmonic Analysis of Torsiograph Records*  
*Blade Angle 25°-50'*

| Engine R.P.M. | Frequency Cycles Per Min. | Order | Amplitude Lb. In. | Engine R.P.M. | Frequency Cycles Per Min. | Order | Amplitude Lb. In. |
|---------------|---------------------------|-------|-------------------|---------------|---------------------------|-------|-------------------|
| 1,035         | 4,140                     | 4     | 11,000            | 1,810         | 4,520                     | 2½    | 3,000             |
|               | 4,660                     | 4½    | 4,000             |               | 5,430                     | 3     | 6,000             |
|               | 109,000                   | 105   | 300               |               | 13,600                    | 7½    | 3,500             |
| 1,190         | 4,760                     | 4     | 3,750             |               | 38,000                    | 21    | 500               |
|               | 5,360                     | 4½    | 5,750             |               | 190,000                   | 105   | 500               |
|               | 125,000                   | 105   | 100               | 1,920         | 4,800                     | 2½    | 8,000             |
| 1,260         | 4,410                     | 3½    | 1,000             |               | 14,400                    | 7½    | 2,500             |
|               | 5,040                     | 4     | 8,500             |               | 40,300                    | 21    | 1,000             |
|               | 5,630                     | 4½    | 1,000             |               | 201,500                   | 105   | 400               |
|               | 26,400                    | 21    | 600               | 2,000         | 5,000                     | 2½    | 12,000            |
|               | 132,400                   | 105   | 200               |               | 42,000                    | 21    | 800               |
| 1,430         | 5,000                     | 3½    | 7,250             |               | 210,000                   | 105   | 200               |
|               | 5,720                     | 4     | 2,750             | 2,040         | 5,100                     | 2½    | 11,500            |
|               | 30,000                    | 21    | 1,000             |               | 42,800                    | 21    | 600               |
|               | 90,000                    | 63    | 400               |               | 214,000                   | 105   | 200               |
| 1,490         | 4,470                     | 3     | 2,750             | 2,140         | 5,350                     | 2½    | 11,500            |
|               | 5,220                     | 3½    | 6,750             |               | 45,000                    | 21    | 500               |
|               | 11,200                    | 7½    | 500               |               | 225,000                   | 105   | 200               |
|               | 31,300                    | 21    | 800               | 2,210         | 5,520                     | 2½    | 8,500             |
| 1,630         | 4,890                     | 3     | 6,500             |               | 13,300                    | 6     | 2,000             |
|               | 5,710                     | 3½    | 2,500             |               | 46,400                    | 21    | 800               |
|               | 9,800                     | 6     | 800               |               | High Freq.                |       | 200               |
|               | 34,200                    | 21    | 600               | 2,320         | 5,800                     | 2½    | 8,000             |
| 1,690         | 5,070                     | 3     | 2,500             |               | 48,700                    | 21    | 1,600             |
|               | 5,920                     | 3½    | 5,000             |               | High Freq.                |       | 200               |
|               | 35,500                    | 21    | 400               |               |                           |       |                   |
|               | 177,500                   | 105   | 500               |               |                           |       |                   |

Amplitude is Half Range.

TABLE 5  
 Harmonic Analysis of Torsigraph Records  
 Blade Angle 29°

| Engine R.P.M. | Frequency Cycles Per Min. | Order | Amplitude Lb. In. | Engine R.P.M. | Frequency Cycles Per Min. | Order | Amplitude Lb. In. |
|---------------|---------------------------|-------|-------------------|---------------|---------------------------|-------|-------------------|
| 1,040         | 2,600                     | 2½    | 7,500             | 1,580         | 2,370                     | 1½    | 4,500             |
|               | 3,120                     | 3     | 5,000             |               | 3,160                     | 2     | 1,500             |
|               | 43,700                    | 42    | 400               |               | 11,850                    | 7½    | 800               |
|               | High Freq.                |       | 100               |               | 33,200                    | 21    | 200               |
| 1,140         | 2,280                     | 2     | 5,500             | 1,690         | 5,070                     | 3     | 7,500             |
|               | 2,850                     | 2½    | 3,000             |               | 12,650                    | 7½    | 800               |
|               | 3,420                     | 3     | 2,000             |               | 35,500                    | 21    | 400               |
|               | 47,800                    | 42    | 400               |               | High Freq.                |       | 100               |
| 1,210         | 2,420                     | 2     | 5,000             | 1,770         | 4,420                     | 2½    | 2,000             |
|               | 3,030                     | 2½    | 2,000             |               | 5,320                     | 3     | 6,000             |
|               | 3,630                     | 3     | 3,000             |               | 10,600                    | 6     | 2,000             |
|               | 50,800                    | 42    | 400               |               | 37,200                    | 21    | 400               |
|               | High Freq.                |       | 100               |               | 186,000                   | 105   | 100               |
| 1,310         | 2,620                     | 2     | 5,000             | 1,900         | 4,750                     | 2½    | 5,000             |
|               | 3,270                     | 2½    | 2,500             |               | 14,240                    | 7½    | 2,000             |
|               | 3,930                     | 3     | 3,000             |               | 39,900                    | 21    | 400               |
|               | 27,500                    | 21    | 500               |               | 79,800                    | 42    | 400               |
|               | 137,500                   | 105   | 300               |               | High Freq.                |       | 100               |
| 1,420         | 2,130                     | 1½    | 2,500             | 1,970         | 4,930                     | 2½    | 8,000             |
|               | 2,840                     | 2     | 9,000             |               | 14,750                    | 7½    | 1,500             |
|               | 10,630                    | 7½    | 800               |               | 20,700                    | 10½   | 1,300             |
|               | 29,800                    | 21    | 400               |               | 41,400                    | 21    | 400               |
|               | High Freq.                |       | 100               |               | High Freq.                |       | 100               |
| 1,500         | 2,250                     | 1½    | 2,250             | 2,070         | 5,130                     | 2½    | 12,000            |
|               | 3,000                     | 2     | 6,250             |               | 43,500                    | 21    | 400               |
|               | 31,500                    | 21    | 300               |               | 218,000                   | 105   | 100               |
|               | High Freq.                |       | 100               |               |                           |       |                   |

Amplitude is Half Range.

TABLE 6  
*Harmonic Analysis of Axial Movement of Engine*  
*Blade Angle 23°*

| Engine R.P.M. | Frequency Cycles Per Min. | Order | Amplitude In. $\times 10^{-3}$ | Engine R.P.M. | Frequency Cycles Per Min. | Order | Amplitude In. $\times 10^{-3}$ |
|---------------|---------------------------|-------|--------------------------------|---------------|---------------------------|-------|--------------------------------|
| 1,000         | 1,800                     | 4 P   | 0.7                            | 1,800         | 2,620                     | 3 P   | 1.9                            |
|               | 3,200                     | 3 E   | 0.6                            |               | 4,800                     | 6 P   | 1                              |
|               | 3,950                     | 4 E   | 0.6                            |               | 11,450                    | 6½ E  | 1                              |
|               | 7,200                     | 7½ E  | 1.1                            | 1,900         | 1,840                     | 2 P   | 1.4                            |
| 1,100         | 1,660                     | 1½ E  | 0.6                            |               | 11,000                    | 12 P  | 1                              |
|               | 4,350                     | 4 E   | 0.8                            | 2,000         | 2,950                     | 3 P   | 0.9                            |
|               | 6,800                     | 6 E   | 1                              |               | 5,100                     | 2½ E  | 2.5                            |
| 1,200         | 1,720                     | 3 P   | 0.6                            |               | 9,400                     | 4½ E  | 1                              |
|               | 4,700                     | 4 E   | 0.8                            | 2,100         | 2,000                     | 2 P   | 1.3                            |
|               | 6,700                     | 12 P  | 0.8                            |               | 5,350                     | 2½ E  | 2.1                            |
| 1,300         | 2,000                     | 3 P   | 0.7                            | 2,200         | 1,100                     | ½ E   | 2.6                            |
|               | 4,400                     | 3½ E  | 1                              |               | 5,600                     | 2½ E  | 1.2                            |
|               | 5,200                     | 4 E   | 1.25                           |               | 9,200                     | 9 P   | 1.4                            |
|               | 8,650                     | 7½ E  | 0.4                            |               | 10,500                    | 5 E   | Trace                          |
| 1,400         | 2,080                     | 3 P   | 1.45                           | 2,300         | 3,300                     | 3 P   | 2.4                            |
|               | 8,300                     | 12 P  | 0.8                            |               | 19,000                    | 18 P  | 1                              |
| 1,500         | 2,180                     | 3 P   | 2                              | 2,400         | 1,200                     | ½ E   | 4                              |
|               | 5,300                     | 3½ E  | 1                              |               | 6,750                     | 6 P   | 0.9                            |
|               | 8,750                     | 12 P  | 1.4                            |               | 9,300                     | 4 E   | 0.8                            |
| 1,600         | 2,320                     | 3 P   | 4.5                            |               | 22,500                    | 9½ E  | 0.6                            |
|               | 8,950                     | 12 P  | 0.8                            | 2,450         | 1,200                     | ½ E   | 2.6                            |
| 1,700         | 2,490                     | 3 P   | 3.8                            |               | 4,500                     | 4 P   | 2.7                            |
|               | 11,000                    | 6½ E  | 0.6                            |               | 11,000                    | 4½ E  | 0.8                            |
|               |                           |       |                                |               | 14,400                    | 12 P  | 1.3                            |

Amplitude is Half Range.  
 E—Indicates engine order.  
 P—Indicates propeller order.