



LIBRARY
ROYAL AIR FORCE ESTABLISHMENT
BEDFORD

PROCUREMENT EXECUTIVE, MINISTRY OF DEFENCE

AERONAUTICAL RESEARCH COUNCIL

CURRENT PAPERS

The Effect of Geometry
on the Fatigue Strength of
Aluminium Alloy Lugs

by

F E. Kiddle

Structures Dept., R.A.E., Farnborough

LONDON: HER MAJESTY'S STATIONERY OFFICE

1976

£1 NET

THE EFFECT OF GEOMETRY ON THE FATIGUE STRENGTH OF ALUMINIUM ALLOY LUGS

by

F. E. Kiddle

SUMMARY

Al 2% Cu alloy lug specimens of five different geometries chosen to represent a range of static strength values, were fatigue tested under constant amplitude loading at ambient temperature. It is shown that the mode of failure was the same in all lug fatigue tests by contrast with the variable mode of failure expected in static tests. A comparison of the fatigue strengths of the lugs shows some correlation with K_t , the net stress concentration factor.

CONTENTS

	<u>Page</u>
1 INTRODUCTION	3
2 MATERIAL AND SPECIMENS	3
3 FATIGUE TESTS AND RESULTS	3
4 COMPARISON OF FATIGUE STRENGTHS	4
5 CONCLUSIONS	4
Tables 1 and 2	5
References	7
Illustrations	Figures 1-5

Conversions: $1000 \text{ lbf/in}^2 = 6.894 \text{ MN m}^{-2} = 0.689 \text{ Hb}$

1 INTRODUCTION

The single pin joint or lug is an important and common element in aircraft design. The design of a lug¹ for static strength must consider shear, bearing and tensile strengths, and the critical stress and mode of failure will depend on the ratios of tension to shear stress and bearing to shear stress.

The purpose of this Report is to examine the fatigue strengths of lugs of differing geometry designed by BAC Ltd. (Filton Division) to give a range of ratios of tension to shear stress and bearing to shear stress and hence a range of static strength values. The tests of aluminium alloy lugs of five different geometries were carried out by Hawker Siddeley Aviation Ltd. under Mintech contract. It is shown that the mode of fatigue failure was the same for all lug geometries; this contrasts with the variable mode of failure which would be expected in static tests. The fatigue strengths of the different lugs are compared and it is shown that there is some correlation with K_t , the net stress concentration factor.

2 MATERIAL AND SPECIMENS

The material used for all specimens was a fully heat treated Al 2% Cu alloy to specification CM 003 (RR 58) in the form of 3 inch thick plate. The chemical composition and tensile properties as stated by the manufacturer are given in Table 1.

Lug specimens (see Fig.1) were extracted with the grain of the material in the transverse direction from different depths in the plate; no specimens were within 0.25 inch of the surface, the region of relatively coarse grain. After manufacture the specimens were anodised to the requirements of BAC MP 1002² and finally the holes were reamed to ensure metallic contact between the pins and bores. Axial loading was applied by round steel pins of clearance fit and all test sections were dry during testing.

Five different geometries of lugs were manufactured as illustrated in Fig.2.

3 FATIGUE TESTS AND RESULTS

All tests were at room temperature under constant amplitude loading in fluctuating tension with a small fixed minimum load to minimise disturbance to the seating of the pins in the lug holes during test. Three specimens of each type were tested at four levels of alternating stress to failure or to lives of about 6×10^6 cycles.

Table 2 gives details of the fatigue stress and number of cycles to failure for each test and Fig.3 is a S-N plot showing curves of log mean endurance - all stresses quoted are based on the net cross sectional area.

The different lug geometries designated O, A, B, C, D in Fig.2 were chosen to provide a range of values for the ratios of tension to shear stress and bearing to shear stress, a/c and $2a/d$ respectively. From simple considerations of the tensile and shear strengths of the material,³ it would be expected that lugs of type O, B, C and D would fail statically by double shear through the end of the lug and that lug type A would fail in the tension mode across the net section. In fatigue all specimens failed through the net sections along a line normal to the applied load.

4 COMPARISON OF FATIGUE STRENGTHS

Fig.3 presents S-N curves of mean endurance for each of the five lug geometries studied. It is seen that over the whole endurance range lug A has superior fatigue strength to the other four lug types which are all of similar performance.

To understand the significance of this result it is helpful to consider the fatigue strengths of the different lugs in relation to their net stress concentration factors (K_t), quoted in Fig.2. These values were derived from Fig.4 which shows the ESDU presentation of K_B , the bearing stress concentration factor⁴. It is seen in Fig.5 that although correlation between fatigue strength and net stress concentration factor is not particularly good, it seems to explain adequately the superiority of the type A lug.

5 CONCLUSIONS

Al 2% Cu alloy lugs of five different geometries giving a range of static strengths were fatigue tested under constant amplitude loading to compare their fatigue performances. The following conclusions were drawn:

- (1) The mode of fatigue failure was across the net section for all lug geometries, whereas it would be expected that under static loading four of the five lug types would fail in double shear.
- (2) The only significant effect on fatigue strength of varying the geometry of the lug appeared to be associated with the stress concentration on the net section.

Table 1

CHEMICAL COMPOSITION AND STATIC STRENGTH OF CM 003 MATERIAL
AS STATED BY MANUFACTURER

Chemical composition:

Element	Cu	Mn	Mg	Fe	Si	Zn	Ti	Ni	Al
Percentage by weight	2.5	0.1	1.4	1.0	0.2	0.1	0.03	1.2	Remainder

Transverse tensile properties:

0.2% proof stress	60 000 lb/in ²
UTS	65 400 lb/in ²
Elongation	7%

Table 2
FATIGUE TEST RESULTS

Specimen geometry identification number	Fatigue stress KSI	Specimen identification number and fatigue endurance -10^5 cycles				Log. mean endurance
0	0-22.5	Identification Endurance	01 0.146	02 0.085	03 0.128	0.117
	0-16.8	Identification Endurance	04 0.179	05 0.189	06 0.203	0.190
	0-12	Identification Endurance	07 0.840	08 1.08	09 0.710	0.864
	0-8	Identification Endurance	010 51.9	011 53.5	012 19.0	37.5
A	0-27.5	Identification Endurance	A24 0.155	A25 0.149	A26 0.155	0.152
	0-22.5	Identification Endurance	A14 0.324	A16 0.358	A17 0.349	0.343
	0-16.8	Identification Endurance	A18 0.938	A19 0.980	A20 1.40	1.09
	0-12	Identification Endurance	A21 60.0 ^{UB}	A22 2.14	A23 60.0 ^{UB}	>19.8
B	0-22.5	Identification Endurance	B27 0.104	B28 0.154	B29 0.099	0.117
	0-16.8	Identification Endurance	B30 0.240	B31 0.309	B32 0.280	0.275
	0-12	Identification Endurance	B33 0.975	B34 0.863	B35 0.721	0.847
	0-8	Identification Endurance	B36 54.5 ^{UB}	B37 54.5 ^{UB}	B38 54.5 ^{UB}	>54.5
C	0-22.5	Identification Endurance	C40 0.073	C41 0.080	C42 0.057	0.069
	0-16.8	Identification Endurance	C43 0.199	C44 0.185	C45 0.203	0.196
	0-12	Identification Endurance	C46 0.691	C47 0.486	C48 0.554	0.571
	0-8	Identification Endurance	C49 4.64	C50 3.87	C51 30.0	8.14
D	0-22.5	Identification Endurance	D53 0.099	D54 0.053	D55 0.067	0.071
	0-16.8	Identification Endurance	D56 0.199	D57 0.180	D58 0.271	0.213
	0-12	Identification Endurance	D59 0.831	D60 0.825	D61 0.866	0.840
	0-8	Identification Endurance	D62 1.45	D63 3.04	D64 3.20	2.42

UB = unbroken

REFERENCES

<u>No.</u>	<u>Author</u>	<u>Title, etc.</u>
1	-	Design requirements for aircraft of the Royal Air Force and Royal Navy. Ministry of Aviation, AvP 970, Vol.1, Leaflet 404/2 (1967)
2	-	Anodic oxidation of aluminium and its alloys (chromatic acid process). BAC Ltd. Manufacturing Process MP 1002
3	-	Lugs in wrought materials other than sheet. BAC Ltd. Structural Design Data Sheets No.15.3.1
4	-	Stress concentration factors, loaded pin in a central circular hole in a flat bar. ESDU (Royal Aeronautical Society) Data Sheet 65004, Fatigue Sub-Series Vol.3 (1965)

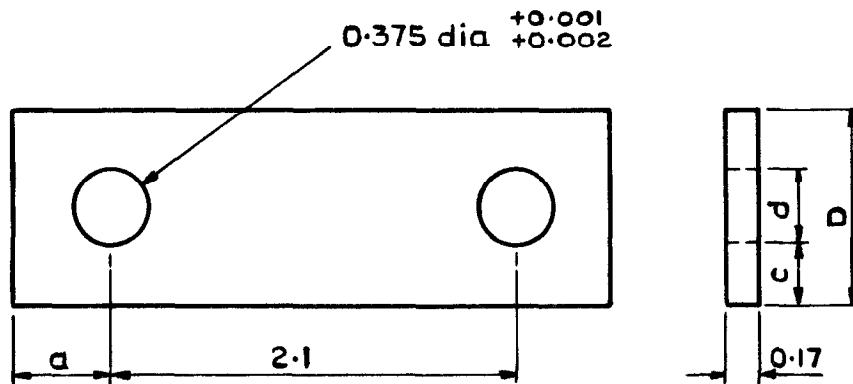

Specimen geometry ident. No	Dimension a	Dimension D	Dimension c
O	0.467	0.959	0.292
A	0.467	0.750	0.188
B	0.660	1.200	0.413
C	0.467	1.155	0.390
D	0.320	0.910	0.268

- 1 All dimensions in inches and tolerances unless otherwise stated ± 0.001
- 2 Holes are on centre-line of specimen within 0.001 and edges of holes are carefully chamfered 0.02
- 3 All edges of specimens are chamfered 0.02
- 4 Surface finish 15μ inches (centre-line average)
- 5 Specimens are anodised to BAC MP1002 (Reference 3), followed by final reaming of holes

Fig.1 Lug specimen

Specimen
geometry
ident.number

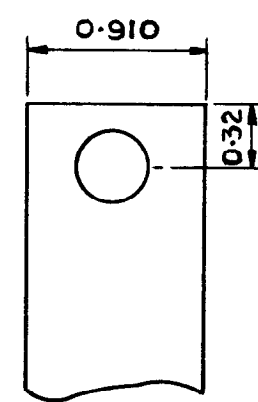
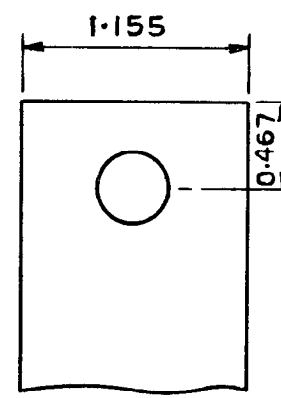
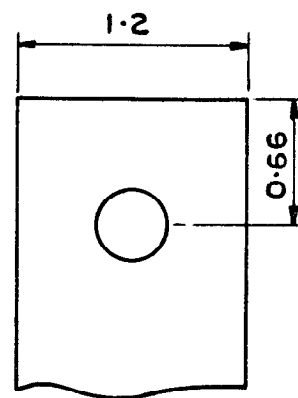
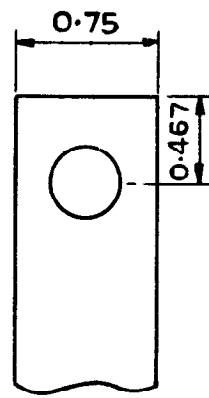
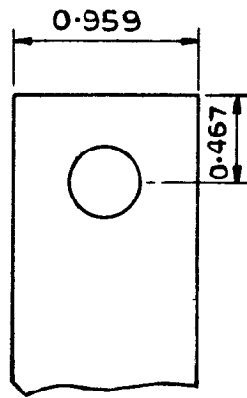

All dimensions in inches

Pin diameter = 0.375

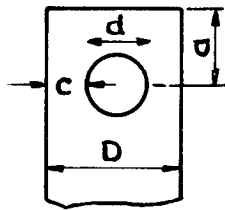

Specimen geometry ident.number	$\frac{2a}{d}$	$\frac{a}{c}$	$\frac{a}{D}$	$\frac{d}{D}$	Geometric stress concentration factor K_t
O	2.5	1.6	0.49	0.391	3.21
A	2.5	2.5	0.62	0.500	2.61
B	3.5	1.6	0.55	0.313	3.78
C	2.5	1.2	0.40	0.325	3.95
D	1.7	1.2	0.35	0.412	3.28

Fig.2 Diagrams of the five lug geometries tested

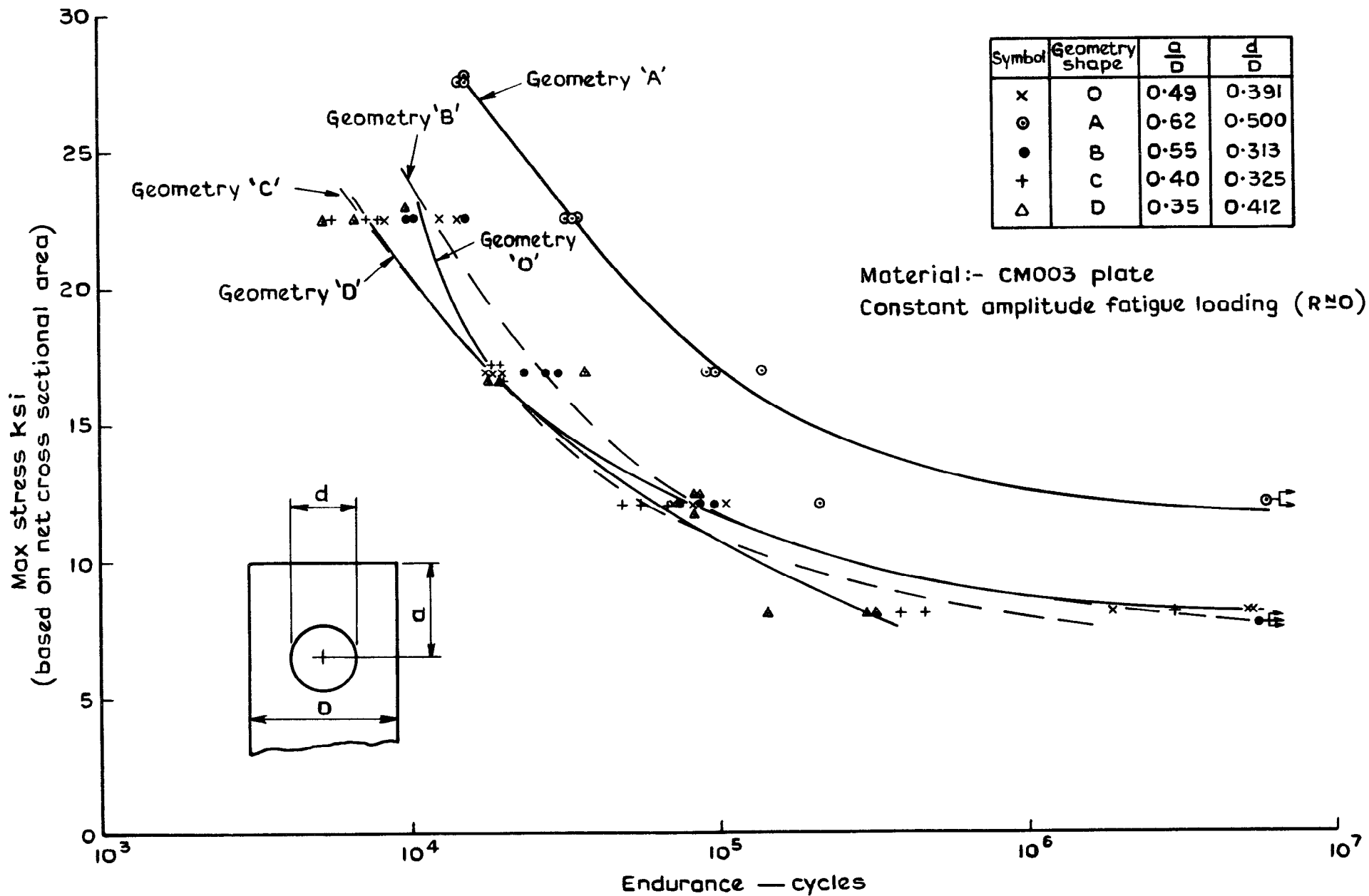

Fig.3 Variation of fatigue endurance with lug geometry

K_B = the bearing cross section stress concentration factor

f_{max} = maximum stress in bar = $K_B f_{ref}$

$$f_{ref} = \frac{P}{dt}$$

K_t = net stress concentration factor = $\frac{D-d}{d} K_B$

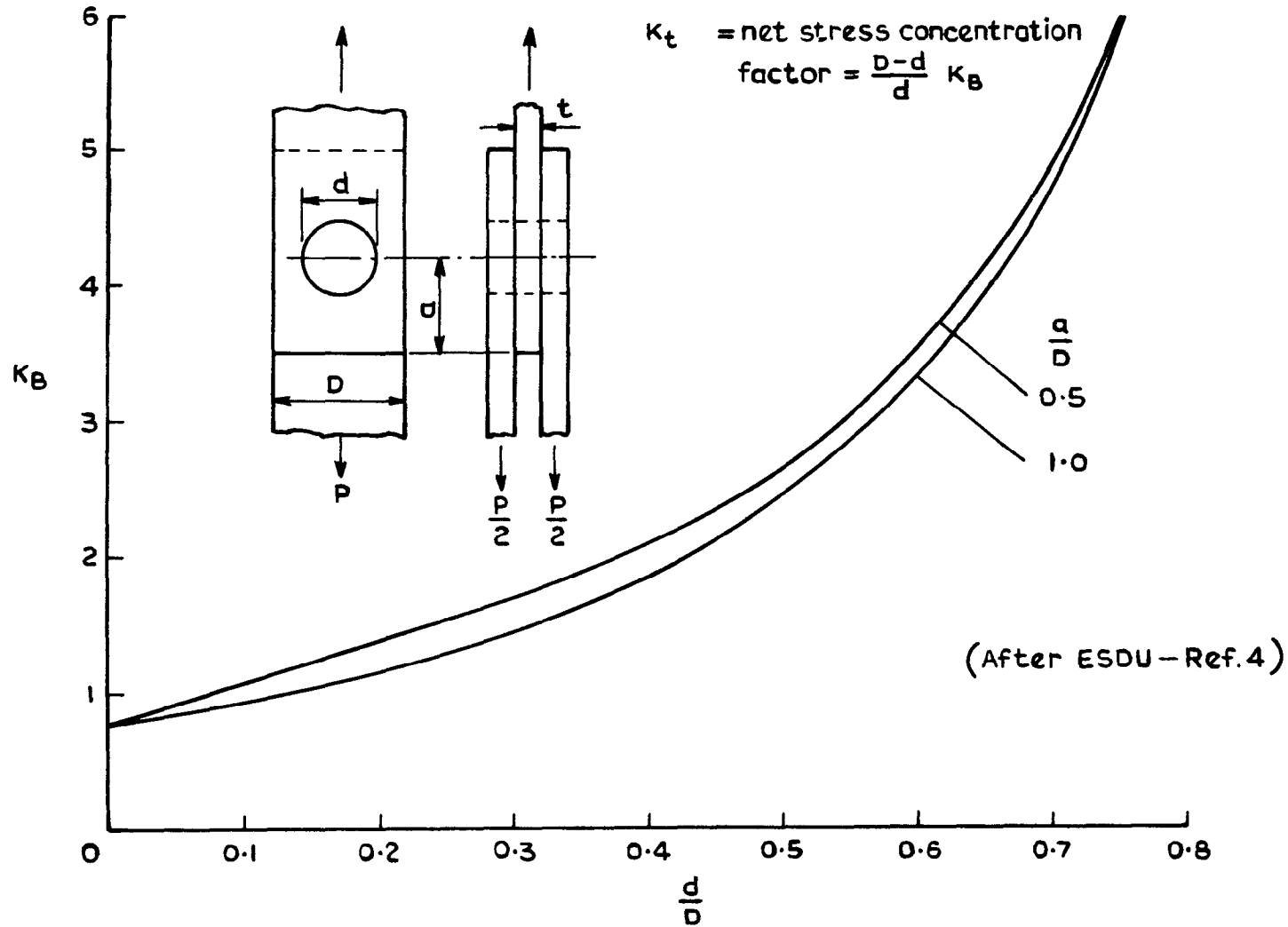

Fig. 4 Standard curves for evaluating theoretical stress concentration factors from ESDU data sheet 65004

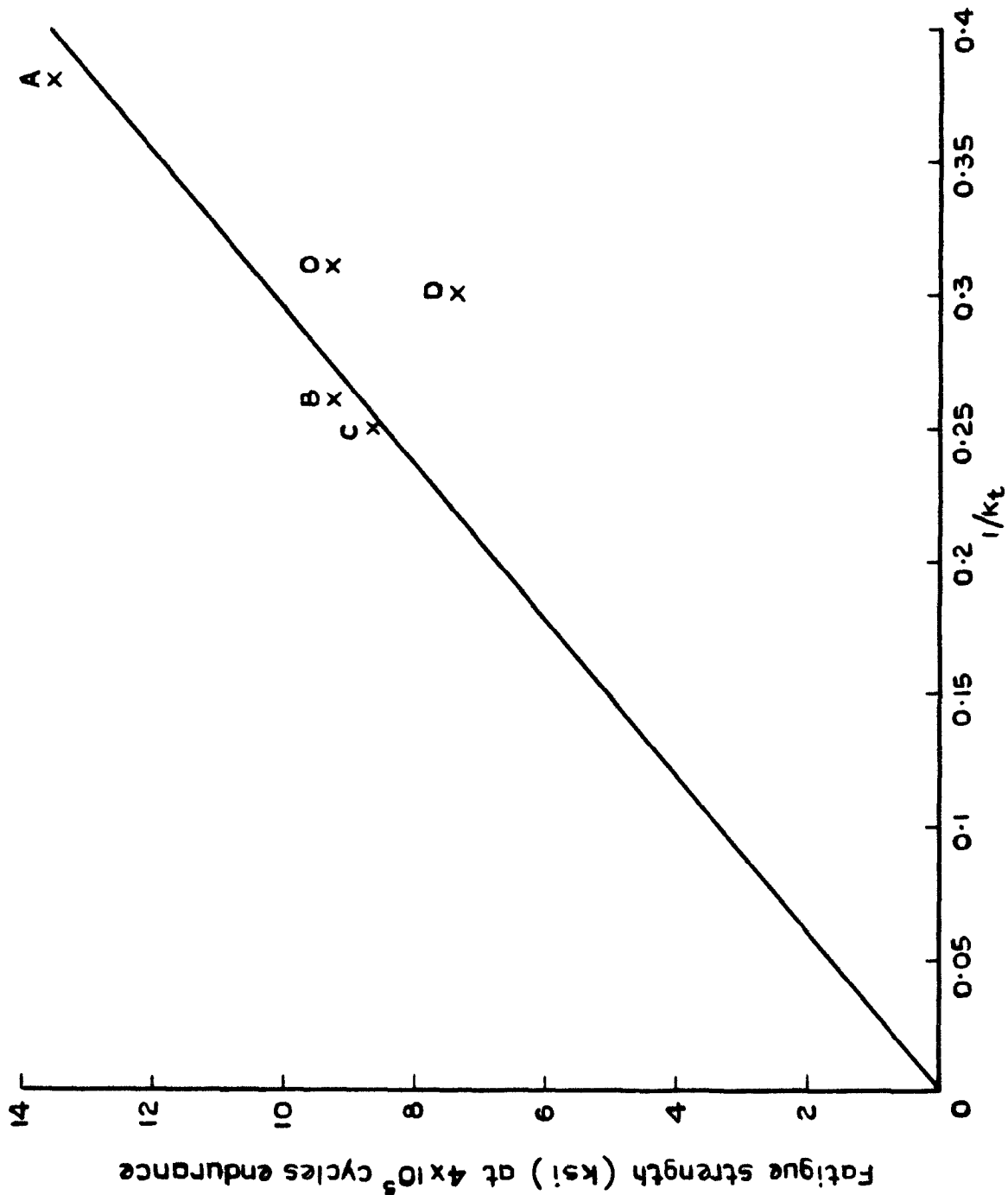

Fig. 5 Relationship between fatigue strength and theoretical geometric stress concentration

ARC CP No.1349
March 1975

F.E. Kiddle

THE EFFECT OF GEOMETRY ON THE FATIGUE STRENGTH OF
ALUMINIUM ALLOY LUGS

Al 2% Cu alloy lug specimens of five different geometries chosen to represent a range of static strength values, were fatigue tested under constant amplitude loading at ambient temperature. It is shown that the mode of failure was the same in all lug fatigue tests by contrast with the variable mode of failure expected in static tests. A comparison of the fatigue strengths of the lugs shows some correlation with K_t , the net stress concentration factor.

621.886.4 :
539.431 :
669.715.3

ARC CP No.1349
March 1975

F.E. Kiddle

THE EFFECT OF GEOMETRY ON THE FATIGUE STRENGTH OF
ALUMINIUM ALLOY LUGS

Al 2% Cu alloy lug specimens of five different geometries chosen to represent a range of static strength values, were fatigue tested under constant amplitude loading at ambient temperature. It is shown that the mode of failure was the same in all lug fatigue tests by contrast with the variable mode of failure expected in static tests. A comparison of the fatigue strengths of the lugs shows some correlation with K_t , the net stress concentration factor.

621.886.4 :
539.431 :
669.715.3

Cut here

ARC CP No.1349
March 1975

F.E. Kiddle

THE EFFECT OF GEOMETRY ON THE FATIGUE STRENGTH OF
ALUMINIUM ALLOY LUGS

Al 2% Cu alloy lug specimens of five different geometries chosen to represent a range of static strength values, were fatigue tested under constant amplitude loading at ambient temperature. It is shown that the mode of failure was the same in all lug fatigue tests by contrast with the variable mode of failure expected in static tests. A comparison of the fatigue strengths of the lugs shows some correlation with K_t , the net stress concentration factor.

621.886.4 :
539.431 :
669.715.3

ARC CP No.1349
March 1975

F.E. Kiddle

THE EFFECT OF GEOMETRY ON THE FATIGUE STRENGTH OF
ALUMINIUM ALLOY LUGS

Al 2% Cu alloy lug specimens of five different geometries chosen to represent a range of static strength values, were fatigue tested under constant amplitude loading at ambient temperature. It is shown that the mode of failure was the same in all lug fatigue tests by contrast with the variable mode of failure expected in static tests. A comparison of the fatigue strengths of the lugs shows some correlation with K_t , the net stress concentration factor.

621.886.4 :
539.431 :
669.715.3

Cut here

DETACHABLE ABSTRACT CARDS

DETACHABLE ABSTRACT CARDS

© *Crown copyright*

1976

Published by
HER MAJESTY'S STATIONERY OFFICE

Government Bookshops

49 High Holborn, London WC1V 6HB

13a Castle Street, Edinburgh EH2 3AR

41 The Hayes, Cardiff CF1 1JW

Brazennose Street, Manchester M60 8AS

Southey House, Wine Street, Bristol BS1 2BQ

258 Broad Street, Birmingham B1 2HE

80 Chichester Street, Belfast BT1 4JY

*Government Publications are also available
through booksellers*