

C.P. No. 1138

C.P. No. 1138



ROYAL  
E. O. O'LEARY

MINISTRY OF AVIATION SUPPLY

AERONAUTICAL RESEARCH COUNCIL

CURRENT PAPERS

Flight Tests to Investigate the Problems  
of Steep Approaches by  
STOL Aircraft

by

*C. O. O'Leary and N. V. Slatter*

*Aerodynamics Dept., R.A.E., Bedford*

LONDON: HER MAJESTY'S STATIONERY OFFICE

1970

PRICE 12s 0d [60p] NET



FLIGHT TESTS TO INVESTIGATE THE PROBLEMS OF STEEP APPROACHES  
BY STOL AIRCRAFT

by

C. O. O'Leary

N. V. Slatter

Aerodynamics Dept., R.A.E., Bedford

SUMMARY

Steep approach tests with a Varsity and an Andover aircraft are described. Using the Varsity aircraft, 243 visual approaches were flown in a statistical experiment which included variations of approach angle, speed, height of entry to the approach, glide path guidance and pilots. A statistical analysis of the effects of the variables on various approach performance parameters was carried out and the significant results are illustrated and discussed. Tests with the Andover aircraft were on a smaller scale and were primarily concerned with the final phase of the approach and landing.

The most important results of the tests are that steep approaches can be accurately and consistently made using a simple form of glide path guidance and landing distances can be decreased without any apparent increase in variability of performance.

---

\* Replaces R.A.E. Technical Report 69277 - A.R.C. 31849.

CONTENTS

	<u>Page</u>
1 INTRODUCTION	3
2 EXPERIMENTAL EQUIPMENT	4
2.1 Test aircraft	4
2.2 Instrumentation	5
2.3 Glide path guidance	6
3 FLIGHT TRIALS	7
3.1 Preliminary tests and Varsity trials	7
3.2 Andover trials	8
4 ANALYSIS OF RESULTS	9
5 DISCUSSION OF RESULTS	10
5.1 Varsity trials	10
5.1.1 Glide path and speed holding	10
5.1.2 Final approach phase	12
5.2 Andover trials	14
6 CONCLUSIONS	16
Table 1 Summary of results	18
References	19
Illustrations	Figures 1-21
Detachable abstract cards	-

1     INTRODUCTION

The advent of military transport aircraft capable of short field performance requires the investigation of steep approach paths needed for terrain clearance when landing on tactical airstrips. There is also a growing interest in steep approach paths for civil transports to alleviate noise over areas surrounding airports. In this case elaborate approach aids would be available, e.g. radar guidance. It is probable that these steep approaches would be terminated at an appreciable height where there would be a transition to a normal  $3^{\circ}$  approach angle prior to landing. These aspects are not considered in the present report but some of the test results may be relevant to civil operations.

The practicability of a steep approach and landing is determined by several factors concerning the piloting and performance of the aircraft. The pilot should be able to make a precise entry onto the glide path with a minimum of flight path and speed oscillation. The height of entry to the approach should therefore be low enough for the pilot to be clearly aware of when to initiate the descent and yet high enough for him to settle down on the correct glide angle before the confines of the landing area are reached. Glide path and speed must be accurately held until the flare is initiated or until the aircraft is flown onto the ground at a constant glide angle, depending on the undercarriage limitations. Glide path and speed holding are important since precise positioning of the aircraft near the threshold of the airstrip is necessary if terrain clearance and short landing requirements are to be satisfied. If it is necessary to reduce rate of descent before touching down the height of flare initiation and the magnitude and rate of elevator application must be accurately judged to achieve an acceptable rate of descent without increasing the landing distance through a long 'float' down the field. The judgement of the flare tends to become more difficult as the angle of approach is increased so it might be expected that there is an approach angle beyond which piloting inaccuracies reach an unacceptable level.

Steepness of approach is also limited by the aircraft's aerodynamic and engine characteristics. In the maximum drag configuration at a given speed, the maximum achievable rate of descent is determined by the engines' idling thrust. Since some power reduction must be available to allow for corrections from positions high on the glide path, the steepest practicable approach angle is smaller than the maximum attainable by one or two degrees,

depending on the maximum errors occurring and the response of the engines at low throttle settings. The minimum acceptable throttle setting may also be dependent on the engine response characteristics when full power is applied for overshoot. The decision on whether a landing is possible from a particular approach may not be made until the aircraft is in the flare and it must therefore be possible to overshoot with only a small height loss.

The consequences of high rates of descent mentioned earlier give a powerful incentive to reduce approach speed which also, of course, directly reduces landing roll distances. But low approach speeds create problems in the handling of the aircraft, such as inadequate lateral and directional stability<sup>1,2</sup> and the consequences of engine failure, which must be taken into account.

In the flight study of techniques applicable to steep approach operations reported here, the factors investigated were angle of approach, approach speed, height of entry, glide path guidance and pilot variability. Two aircraft were used for the trials. A twin piston-engined Varsity aircraft was available for a statistical study of the approach characteristics up to the start of the flare, but since it did not have a sufficiently strong undercarriage for safe touchdowns in these conditions, subsidiary landing tests were made with an Andover aircraft.

## 2 EXPERIMENTAL EQUIPMENT

### 2.1 Test aircraft

The Vickers Varsity T. Mk.1 (Fig.1) is a mid wing monoplane powered by two Bristol Hercules 264 piston engines and is normally used as an aircrew trainer. The normal approach and target threshold speeds for the aircraft are 105 kt and 85 kt respectively, and since these are rather high in comparison with current STOL aircraft, tests were made to determine the lowest approach speed which could be used with adequate safety margins for the flare and allow glide path control about a  $10^{\circ}$  approach angle. An airspeed of 90 kt was found to be satisfactory, although some headwind was necessary to achieve the descent capability necessary for a  $10^{\circ}$  approach. Control about all axes was adequate with powerful elevator response. A good view of the touchdown area could be maintained, even at the shallowest approach angle. With full flap the stall occurred at 67 kt indicated airspeed with power off and 64 kt with approach power at the maximum landing weight of 36000 lb. Important characteristics of STOL aircraft are a facility for

lift 'dumping' before touch-down and a strong undercarriage enabling accurate, high rate of descent landings to be made. Unfortunately, the Varsity is limited to the rather low touch-down rate of descent of 6 ft/sec and tends to 'float' near the ground after the initial flare has been made.

The Hawker Siddeley Andover C. Mk.1 (Fig.2) is a 'semi-STOL' tactical military transport aircraft powered by two Rolls Royce Dart 201 turbo-prop engines. All flying controls are conventional but the Fowler flaps fitted have been modified to include a tab along the trailing edge to give increased lift and drag in the landing configuration. There are no spoilers. To achieve a short landing run the propellers can be used to assist braking. Just before touch-down, reverse thrust can be selected or, alternatively, if a conventional touch-down is preferred, the propellers can be put into fine pitch to provide windmilling drag once the aircraft is on the ground. The use of reverse thrust requires a 'reverse idle' selection during the approach and the minimum fuel flow rate with throttles closed is increased. There is then more thrust than when 'normal idle' is selected and the steepest possible approach is not achieved. Mainly because of this limitation reverse thrust was not used in the present tests. The manufacturers recommended minimum target threshold speed at the maximum landing weight of 42000 lb is 85 kt and this speed is used for the entire approach. The power off stalling speed is 70 kt in the landing configuration and is reduced by 4 kt with approach power. The maximum permissible rate of descent at touch-down is 14 ft/sec and the cross wind limitation for steep approaches is 15 kt.

## 2.2 Instrumentation

The Varsity was already instrumented for automatic approach and landing and this equipment was used without modification. Quantities selected from the conventional trace recordings were airspeed, elevator angle, and height measured by radio altimeter. Glide path and horizontal and vertical ground speeds were measured with kinetheodolites which also sent a synchronising radio pulse to the airborne recorders.

The Andover was comprehensively instrumented for R.A.F. acceptance trials and trace recordings of the required quantities were available. In this case height was measured by a sensitive pressure altimeter and could be checked by kinetheodolite records. Kinetheodolite pulses could not be recorded and synchronisation with the airborne recorders was achieved either by using an Aldis lamp from the cockpit of the aircraft when it was being filmed or by reference to the touch-down point.

Surface wind speed and direction was measured near the runway for each approach.

### 2.3 Glide path guidance

A simple form of visual ground guidance for an approach over an obstacle would consist of an aiming mark on the ground positioned so as to give the desired approach angle when aligned with the top of the obstacle, allowing for an appropriate margin of clearance over the obstacle. If the aiming mark was in the form of a horizontal bar, and a large ring mounted on a pole was positioned in front of it, this simple 'ring and bar' sight could be used as shown in Fig.3.

In the present tests a 50 ft obstacle was simulated by projecting jets of water to form a barrier with a normal height of 50 ft. For the Varsity trials a single nozzle was mounted on a 35 ft gantry, because of insufficient water power, and the jet directed across the runway as shown in Fig.4. The jet tended to break up soon after leaving the nozzle and was sensitive to wind speed and direction. In unfavourable conditions when there was a cross wind blowing the jet back towards the nozzle the aircraft did not have to fly over the barrier and this reduced the compulsion to clear the barrier by a safe margin. Also, owing to an inadequate water reserve the supply was turned on just before the aircraft began its approach so that at times the jet was late in developing and rather low.

For the Andover trials a pair of nozzles was mounted on the runway threshold 40 ft apart and pointing nearly vertically upwards but slightly inclined towards each other. Two stage pumping was used to provide adequate pressure and water volume. The pump operator was provided with a simple reference sight and was able to control the height of the twin jets to  $50 \pm 5$  ft. This improved barrier is shown in Fig.5.

The plywood ring of the sight, 5 ft in diameter and 1 ft wide, was faced with red 'dayglow' material and mounted on a metal pole which could be placed in prepared sockets on the runway edge to give a constant height. The bar was 1 ft wide and 24 ft long (three 8 ft sections) and was painted 'dayglow' yellow. It was propped up behind the ring so as to define the required glide angle when viewed through the centre of the ring. For the Varsity tests, the sight was set to give a wheel clearance of approximately 8 ft over the barrier, but for the Andover tests this was increased to 15 ft. The sight, shown in Fig.6, could be used down to flare height. To enable it to be used in the very late stages of the Andover approaches the length of



the bar was extended to the right of the ring when viewed from the aircraft. The bar could then still be seen through the ring after the aircraft had passed over the barrier.

The 'dayglow' showed up well when the main light from the sky was reflected towards the approaching aircraft and the sight could be picked up from 3 to 4 miles range. However, when the main light was from behind the painted surface it was very difficult to see the boards at distances over 1 mile, although the ring could be seen earlier. This situation could be improved to some extent by tilting the boards of the bar backwards to reflect the sky light.

### 3 FLIGHT TRIALS

#### 3.1 Preliminary tests and Varsity trials

Since the pilots had little or no experience of flying steep approaches, some preliminary tests were made for learning purposes and to determine the scope of the experimental programme proper. A Devon and a Meteor aircraft were used for these tests. A variety of approach angles, entry heights and speeds were tried and the height of initiation of the flare was deliberately varied. For glide path guidance a coloured light ground sight (HILO) was used and a 50 ft barrier was simulated by the gantry water jet described in section 2.3. The HILO sight was later replaced by the 'ring and bar' sight also described in section 2.3 because the latter gave better 'rate information' during tracking (see section 5.1.1).

Based on the experience of the preliminary tests a factorial experiment was designed for the Varsity in which each of five factors were varied at three levels:

	<u>Factors</u>	<u>Levels</u>		
		1	2	3
1	Glide path angle	4°	8°	10°
2	Glide path guidance	Barrier	Ground sight	Barrier and ground sight
3	Approach entry height	500 ft	1000 ft	1500 ft
4	Approach speed	90 kt	100 kt	110 kt
5	Pilot	A	B	C

In this experiment there was a total of  $3^5 = 243$  approaches covering every combination of factors and levels. If there is complete control over the factors in a factorial experiment the important results can be obtained by performing only a fraction of the total number of runs, but in the present

flight trials it was impracticable and time wasting to arrange flights where all factors could be varied at will from one approach to the next.

No aiming mark was set up when the barrier was used on its own, to see whether pilot-selected ground features would prove to be adequate as 'aiming marks'.

The approaches were not flown in any particular order, being dependent on availability of pilots, equipment and weather. In general, it was necessary for the glide path angle, guidance and pilot to remain constant for a number of runs during any particular flight. Some attempt was made to eliminate the effects of learning by arranging that no one pilot flew a consecutive group of flights at the same glide path angle.

The experiment was completed in 33 flights. Each flight consisted of an average of 8 approaches, usually shared by 2 pilots. The same runway was used for all flights and limiting weather conditions were wind strength less than 20 kt (less than 5 kt tail wind component) and visibility better than 4 miles. The aircraft was operated at a mean weight of 35000 lb. Flap settings were  $47^{\circ}$  (full flap) for the  $8^{\circ}$  and  $10^{\circ}$  approaches and  $30^{\circ}$  for the  $4^{\circ}$  approaches. The approach speeds of 90, 100 and 110 kt gave lift coefficients of 1.30, 1.06 and 0.87 respectively.

The pilots were briefed for the trials, substantially as follows:

- (1) Fly level on the runway heading at the approach entry height until the glide path is intercepted.
- (2) The point of interception is to be identified by reference to the ring and bar sight and/or the barrier.
- (3) Fly the approach holding speed and glide path as accurately as possible with reference to ground aids and/or the rate of descent indicator.
- (4) The flare is to be as late as possible consistent with being able to reduce the rate of descent to less than 6 ft/sec before a possible landing. An overshoot may be initiated before the actual touch-down.

### 3.2 Andover trials

These trials were confined to 5 programme flights comprising a total of 54 approaches and landings plus a limited number of practice flights. The experimental format was as follows:

	<u>Factors</u>	<u>Levels</u>		
		1	2	3
1	Glide path angle	4°	6°	8°
2	Glide path guidance	None	Barrier and aiming bar	Barrier and ground sight
3	Pilots	D	E	F

A complete factorial experiment consisted of 27 runs and each run was repeated once. All three pilots were experienced test pilots but only one was experienced on the aircraft type. As for the Varsity trials, two pilots shared each flight and from practical considerations it was necessary to fly the approaches in groups of three at the same glide path angle. Weather limitations were approximately the same as in the case of the Varsity but for STOL, the cross wind limitation was 15 kt.

The weight of the aircraft during the test varied between 42000 lb and 38000 lb. Approach speeds recommended in Pilots' Notes were used for all approaches, and with full flap (30°) selected, the resulting approach lift coefficient was 2.06. Approach entry height was 800 ft. Pilots were given a similar briefing to that for the Varsity trials except that landings were required off all approaches and touch-down distances were to be as short as possible consistent with the undercarriage limitations.

#### 4 ANALYSIS OF RESULTS

The quantities measured to assess approach and landing performance are listed below, together with the aircraft for which results were analysed.

(1)	Glide path holding	-	Varsity
(2)	Speed holding	-	Varsity
(3)	Height at the barrier	-	Varsity, Andover
(4)	Glide slope error at the barrier	-	Varsity, Andover
(5)	Height of initiation of the flare	-	Varsity, Andover
(6)	C <sub>L</sub> at peak normal acceleration in the flare	-	Andover
(7)	Airspeed at touchdown	-	Andover
(8)	Touch-down rate of descent	-	Andover
(9)	Distance of touch-down point from barrier	-	Andover

Glide path and airspeed error were read at 1/5 sec intervals from the kinetheodolite and flight records respectively. Mean glide path errors and mean and standard deviations of speed errors were computed for each approach. Height and glide path error at the barrier and the distance of touch-down from the barrier were calculated from the kinetheodolite records. Height of initiation of the flare, maximum normal acceleration

and airspeed at touch-down were read from the respective flight recorder traces. In the case of the Varsity tests no distinction was made between runs with and without an actual touch-down. Touch-down rate of descent was determined from undercarriage strain gauge instrumentation on the Andover.

The results were analysed using the analysis of variance<sup>3</sup>. This technique allows the important effects of each factor and interactions between factors to be identified. Only first order interactions are considered in the present report. A first order interaction occurs when the effect of one factor is dependent upon the value of another factor, e.g. height at the barrier may be affected by the type of glide path guidance used for 4° approaches but not for 8° approaches. Results presented for the Varsity show the effects of only those factors or interactions found to be significant at a 95% confidence level. For some Andover results none of the factors had a significant effect but all results are presented since the general level and variability of the measurements is of interest. Table 1 indicates significant factors for each measured quantity for both the Varsity and Andover tests.

## 5 DISCUSSION OF RESULTS

### 5.1 Varsity trials

#### 5.1.1 Glide path and speed holding

On all approaches the pilots' initial task was to decide when to commence the glide using the visual guidance available. Because of the significance in relation to terrain clearance, glide path errors were computed in terms of height differences from the theoretical glide slope. The data were analysed from the approach entry point onwards and the results might thus be expected to show larger errors for the higher entry height approaches, where a small angular error in flight path would produce a relatively large height error compared with the corresponding error on a low entry height approach. But unless visibility was very good, pilots found it difficult to locate the sight from high entry heights, so from this aspect they were genuinely undesirable. However, accurate glide path holding during the initial stages of approaches is only important if there is little time available before reaching a critical point on the approach path, such as the barrier, and this was not the case for the approaches from 1500 ft.

Fig.7 shows that at  $4^{\circ}$ , using the sight only, most of the mean approach errors were negative, indicating that pilots were perhaps tending to fly the usual  $3^{\circ}$  approach until the sight could be used. But a high proportion of negative errors for 500 ft entries is surprising since the sight should have been usable throughout the approach. A survey of the data for individual approaches revealed that the aircraft was consistently low on the glide path during the initial stages and this suggests that even with the sight, pilots preferred to anticipate the entry to avoid all possibility of overshooting it and getting too high. When the barrier was used with the sight, much more accurate interceptions were made since the barrier could be much more readily seen. Besides being a glide path aid in itself, it also helped in locating the sight, enabling earlier use of the sight in conjunction with the top of the barrier.

For 500 ft interceptions on  $8^{\circ}$  and  $10^{\circ}$  approaches, little time was available on the glide path and it was necessary to make precise power reductions at entry. Pilots' found that the manoeuvre was easier at 90 kt because of the simplicity of reducing power to the virtually flight idle setting required, compared with finding an intermediate setting at the higher speeds.

Fig.7 also shows that the best glide path holding was achieved with the sight and barrier. Pilots were unanimous that the sight was of great assistance in holding an accurate glide path until a height of approximately 50 ft, giving good closing rate information as well as position information. For approaches with the sight only, the large mean errors could be due to the early part of the approaches being flown with the sight unusable, as explained earlier in this section, but there may also be an effect from decreasing sight sensitivity with increasing glide angle. Sight sensitivity is decreased when the bar is moved nearer the ring to steepen the glide angle. When they first used the sight pilots complained that they made corrections in the wrong sense because they tended to treat the sight as a flight director with the ring as the fixed aeroplane symbol. Thus a low situation should have been indicated by the bar above the ring, whereas with the ground sight this indicates a high situation. When approaches were made with the barrier alone, the technique was to use the top of the barrier and an intended touch-down point as a guide to fly a fixed approach angle and modify this angle in the last 200 ft only if it was obvious that a large miss would occur or there would be a 'dangerously' small clearance.

Mean airspeed errors shown in Fig.8 indicate that there is a marked difference in the errors in mean speeds for the three different nominal approach speeds, and the results suggest that 100 kt was the most 'comfortable' speed. The large positive mean errors for the 90 kt approaches are explained by the fact that at this speed, with full flaps and idling power set, the maximum glide angle available was approximately  $10^{\circ}$  in a 5 kt headwind increasing to  $12^{\circ}$  in 20 kt, so that for all  $10^{\circ}$  approaches in low wind conditions there was a tendency to fly faster than 90 kt, especially when regaining the correct glide slope from a high situation. High situations frequently arose because of wind shear effects, and also during the early stages of approaches starting at 1500 ft when the sight could not be used. Negative mean speed errors for 110 kt approaches are not easily explained. Pilots did comment that although there was no great difficulty in flying at 110 kt, large power changes were often required to hold speed in turbulence and when correcting from low situations. A steeper increase in profile drag would tend to keep speed errors negative.

Fig.9 shows that the standard deviation of airspeed is less for the steeper approaches, lower speeds and when the sight and barrier aids were used. The better guidance from the sight and barrier seems to have enabled the pilots to devote more attention to speed holding but reasons for the effects of glide slope angle and speed are not so apparent. It is suggested that easier acquisition of the near idling power setting required for the steeper and lower speed approaches aided speed holding, but on the other hand, the probability of speed increases when correcting from situations high on the glide path would tend to offset this advantage.

#### 5.1.2 Final approach phase

The object of making an accurate approach is to achieve optimum positioning of the aircraft for the subsequent flare and landing. In the pitch plane, height and glide angle at the 50 ft barrier position are significant quantities. The flare initiation height also has an important influence on the resultant landing distance. The effects of significant variables on glide path and height at the barrier and flare initiation height are illustrated in Figs.10, 11 and 12. Points showing height at the barrier to be less than 50 ft do not indicate that the barrier was fouled since barrier height varied appreciably owing to gusts and water pressure variations. On all figures the solid columns show mean values.

The following observations can be made by examination of Figs.10, 11 and 12.

(a) There are higher mean values and more scatter in height and glide path angle error at the barrier for the steeper approach angles, except in the case of pilot A who was more consistent in all these results than the other two pilots (Figs.10 and 11).

(b) The sight was effective in reducing the mean and the scatter of height at the barrier, especially in the case of  $10^{\circ}$  approaches (Fig.10).

(c) When the barrier was used without the sight, heights at the barrier were increased and more scattered in the cases of pilots B and C, but again pilot A's performance was not affected (Fig.10).

(d) Glide path angle was steepened to reduce barrier clearance on  $8^{\circ}$  and  $10^{\circ}$  approaches without the sight (Fig.11). When the sight was used glide path angles were generally reduced, especially for  $10^{\circ}$  approaches.

(e) Height of flare initiation was generally lower at  $4^{\circ}$  than at  $8^{\circ}$  and  $10^{\circ}$  but pilot A showed less tendency to flare earlier on the steeper approaches (Fig.12).

(f) When using the sight alone pilot C flared consistently late (at a mean height of 30 ft) at all approach angles. Without the sight pilot B tended to initiate the flare early (Fig.12).

(g) When the sight and barrier was used, glide angle at the barrier was shallower for 1000 and 1500 ft entry heights, than for a 500 ft entry height (Fig.11).

The type of barrier used in the trials did not properly simulate typical obstacles met with in practice and this must have affected the results to some extent. Since it was not possible to project water far enough onto the runway the aircraft usually passed to one side of the barrier with only part of one wing actually over it. Pilots commented that this made it more difficult to judge their clearance than if the flight path had been directly over the barrier. However, there is not much doubt that use of the sight increases the pilot's ability consistently to achieve near optimum positioning of the aircraft for the flare and landing. If a pilot was unfamiliar with a particular approach path, in terms of angle of approach and terrain, the sight would be particularly useful in giving him confidence that the aircraft was on the glide path at the critical point of the approach and that a safe landing could be made. Without the sight pilots concentrated on achieving a 'close miss' of the barrier and if the glide was inaccurately

held during the latter stages of the approach, rate of descent prior to the flare was often far from the target value, with the risk of a high rate of descent at touch-down or a long landing distance.

Since the Varsity had ample elevator power and stall margin even at the lowest speed used, it could be flared comfortably from a height of 30 ft and it is estimated that, even on a  $10^\circ$  approach, flares could be initiated lower. But one pilot stated that 30 ft was the "psychological barrier" and "the lowest point he would dare to go". Up to this point a rate of descent of even 1700 ft/min could be tolerated! Although flares from  $8^\circ$  and  $10^\circ$  approaches were in general initiated earlier than from  $4^\circ$ , the heights were less than might be expected and the variability is much the same for all approach angles. When the sight alone was used flare initiation heights for pilot C are seen to be consistently lower than for the other two pilots. During the final stages of an approach the sight becomes unusable between 50 ft and 30 ft when the bar moves outside the ring as viewed from the aircraft and it is possible that pilot C used this feature as a cue to look away from the sight and initiate the flare. With the barrier present there was probably less inclination to refer to the sight when clearing the barrier and judging the subsequent flare.

The different approach speeds invoked little pilot comment except that they had a slight preference for the lower speeds because at 110 kt the aircraft was very sensitive to elevator inputs and overcontrolling often resulted. However the later stages of the flare were usually deliberately prolonged to avoid high rates of descent near the ground and representative results of the effects of approach speed on the landing characteristics were not obtained.

## 5.2 Andover trials

The discussion in this section is concerned with the final stages of the approach and landing. The results for all pilots are considered together since a preliminary analysis showed no significant differences due to pilots. Fig.13 illustrates the differences in flight path and touch-down distance of typical  $4^\circ$ ,  $6^\circ$  and  $8^\circ$  approaches using the sight and barrier. The time histories of these approaches shown in Fig.14 indicate that there was no appreciable increase in elevator activity on the three approaches but flare initiation began earlier and speed decrement was more rapid in the case of the  $8^\circ$  approach.



Histograms of height and glide path at the barrier are shown in Figs.15 and 16. Those results for approaches where the barrier was not present indicate the height and glide path of the aircraft at a range where it should, theoretically, have been clearing a 50 ft barrier. When the barrier is present the mean heights at the barrier are greater than the target value and also show an increase in comparison with the Varsity results. It is probable that this increase was caused by the barrier being directly under the approach path, rather than to one side as in the Varsity tests. Pilots commented that the vertical water jets were very effective in encouraging a 'definite miss!'. The large scatter of heights at the barrier, even when the sight was used, is surprising since it was generally expected that judgement of clearance would be improved through flying directly over the barrier. However, the Varsity results indicated that clearances over the barrier varied significantly between pilots and the differences between the Varsity and Andover results may well reflect this tendency. It is also possible that greater familiarity with the Varsity and its straight-forward handling characteristics caused these results to be more consistent.

On approaches when only the aiming bar was used with the barrier there is some increase in scatter in glide path angle and height at the barrier compared with sight-aided approaches (Fig.16). As for the Varsity tests, pilots said that the sight gave "confidence and confirmation" during the final critical stages of the approach. Using the bar only with the barrier gave good guidance but the top of the barrier could not always be clearly distinguished, especially in strong winds which tended to disperse the water at the top of the jets. With only the runway aiming point, results are seen to be very erratic for the  $6^{\circ}$  and  $8^{\circ}$  approaches and pilots confirmed that these were very difficult. One pilot felt that he would be able to approach down to about 500 ft with just an aiming mark but during the later stages the sight was invaluable.

Fig.16 shows that for  $4^{\circ}$  approaches the glide path at the barrier was steeper than the nominal value, whereas at  $8^{\circ}$  it was shallower. At a given range from the barrier, say 1000 ft, the aircraft would be only 70 ft above the barrier at  $4^{\circ}$  compared with 140 ft at  $8^{\circ}$  and it is possible that pilots flew on the high side on  $4^{\circ}$  approaches to avoid any possibility of getting low and having to use large power increments at a late stage. The consequence of this would be a steepening of the glide angle at a later stage to achieve a 'close miss' of the barrier. Fig.17 shows that on  $8^{\circ}$  approaches

the flare was begun above 50 ft on most occasions and this would account for the mean glide path at the barrier being lower than the nominal  $8^\circ$ .

Heights of flare initiation are lower and less variable for  $4^\circ$  approaches (Fig.17) but Figs.18 and 19 show that there is no detectable increase in the variability of  $C_L$  at peak  $g$  or distance of touch-down from the barrier for the steeper approaches. Calculated lift coefficients appear to be quite near  $C_{L_{max}}$  (power off), especially at  $8^\circ$  and surprisingly, at  $4^\circ$ . However, at these heights, calculation of  $C_L$  would be unreliable due to ground effect on indicated airspeed, and  $C_{L_{max}}$  itself may be affected. At no time did the pilots feel that the aircraft was dangerously close to the stall.

Perhaps the most significant result of the tests is that steeper approaches, with rates of descent up to 1300 ft/min, lead to shorter airborne landing distances without increase in variability. Fig.19 shows a mean decrease of approximately 150 ft between  $4^\circ$  and  $6^\circ$  and the same reduction between  $6^\circ$  and  $8^\circ$ , and in the case of approaches with the barrier and sight or bar there is no apparent increase in scatter. Rates of descent at touch-down (Fig.20) are slightly increased at  $6^\circ$  and  $8^\circ$  but again there is no increase in scatter. Airspeeds at touch-down (Fig.21) are similar for all angles of approach. Since reverse thrust was not used to touch-down, the aircraft bounced on most occasions, irrespective of steepness of approach. The distances shown in Fig.19 refer to initial touch-downs. Bounces may well have been eliminated by the use of reverse thrust but  $8^\circ$  approaches would not then have been possible because of the requirement for a higher idling fuel flow during the approach.

Pilots did not experience any particular handling problems associated with the steepness of the approach. The flare was controlled with elevator, usually without power adjustments until just before touch-down. Some difficulty was experienced in lateral control during the approach. There was a tendency to wander in heading which was thought to originate from asymmetric thrust due to inaccurate synchronisation of the engines following power adjustments. Although pitch control was adequate at the approach speeds used, the aircraft would not have survived an engine failure at these speeds owing to insufficient lateral control.

## 6 CONCLUSIONS

Steep approach flight tests have been made with a Varsity and an Andover aircraft, in which pilots used simple glide path guidance to fly

at different approach angles and speeds. The following conclusions can be drawn from the results:

(i) Steep approaches up to  $10^\circ$  could be safely and consistently made using simple visual glide path guidance. The Andover aircraft could be landed from  $6^\circ$  and  $8^\circ$  approaches in shorter distances than from a conventional approach without any evidence to suggest that there was a consequent increase in variability or decrease in safety margins.

(ii) Use of a ring-and-bar sight improved glide path holding and gave pilots confidence in achieving a successful landing from a steep approach. It enabled the aircraft to be consistently flown to a favourable position for the flare and landing, especially when used in conjunction with a 50 ft barrier. The usefulness of the sight was to some extent limited by adverse visibility conditions but could almost always be of some help to the pilot during the later stages of the approach.

(iii) A 500 ft height of entry to the approach was found to be adequate for  $4^\circ$  approaches but a 1000 ft entry was preferred for steeper angles. 1500 ft was considered too high because the sight could not be seen well enough for use during the initial part of the approach.

(iv) For the aircraft used in the trials, approach speed did not have a significant effect on the ability of the pilots to fly steep approaches except in so far as the decrease of drag with decreasing air-speed limited the glide angle attainable.

(v) There were significant differences in the consistency and accuracy of approaches by different pilots.

(vi) A reasonably effective simulation of a barrier was achieved by the use of water jets.

---

Table 1 - SUMMARY OF RESULTS

Quantity	Aircraft	Variable factors				
		Entry height	Approach angle	Approach speed	Glide path aid	Pilot
Glide path holding	Varsity	s <sub>V</sub>	s <sub>V</sub>		s <sub>V</sub>	
Speed holding	Varsity		s <sub>V</sub>	s <sub>V</sub>	s <sub>V</sub>	s <sub>V</sub>
Height at the barrier	Varsity		s <sub>V</sub>	s <sub>V</sub>	s <sub>V</sub>	s <sub>V</sub>
	Andover	-	s <sub>A</sub>	-	s <sub>A</sub>	
Glide slope error at the barrier	Varsity	s <sub>V</sub>	s <sub>V</sub>		s <sub>V</sub>	s <sub>V</sub>
	Andover	-	s <sub>A</sub>	-	s <sub>A</sub>	
Height of initiation of flare	Varsity		s <sub>V</sub>		s <sub>V</sub>	s <sub>V</sub>
	Andover	-		-		
C <sub>L</sub> at peak normal acceleration in the flare	Andover	-		-		
Airspeed at touch-down	Andover	-		-		
Rate of descent at touch-down	Andover	-		-		
Distance of touch-down from barrier	Andover	-	s <sub>A</sub>	-		

Key:

- s<sub>V</sub> = significant effect (Varsity)
- s<sub>A</sub> = significant effect (Andover)
- = effect not measured
- blank = no significant effect

REFERENCES

- | <u>No.</u> | <u>Author</u>  | <u>Title, etc.</u>   |
|------------|--|--|
| 1          | Hervey C. Quigley  | Handling qualities and operational problems of a large four-propellor STOL transport airplane.<br>NASA T.N. D-1647, January 1963       |
| 2          | Seth B. Anderson<br>Hervey C. Quigley<br>Robert C. Innis | Stability and control considerations for STOL aircraft.<br>Paper presented to Flight Mechanics Panel of AGARD Paris, France, June 1965 |
| 3          | -  | Design and analysis of industrial experiments.<br>Edited by Owen L. Davies.<br>Published by Oliver and Boyd, 1963.                     |



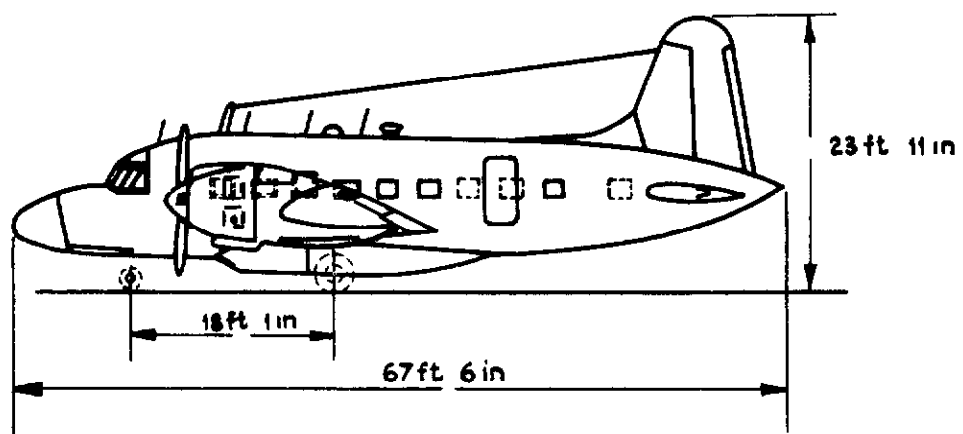
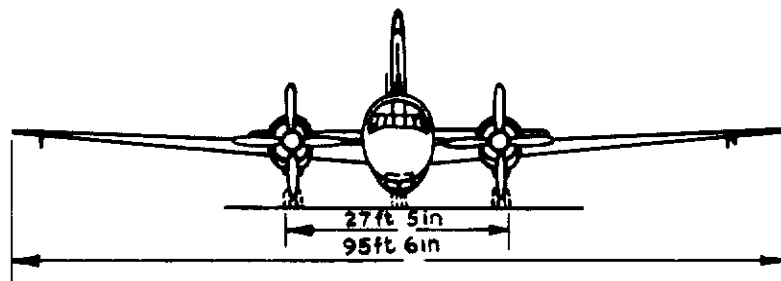
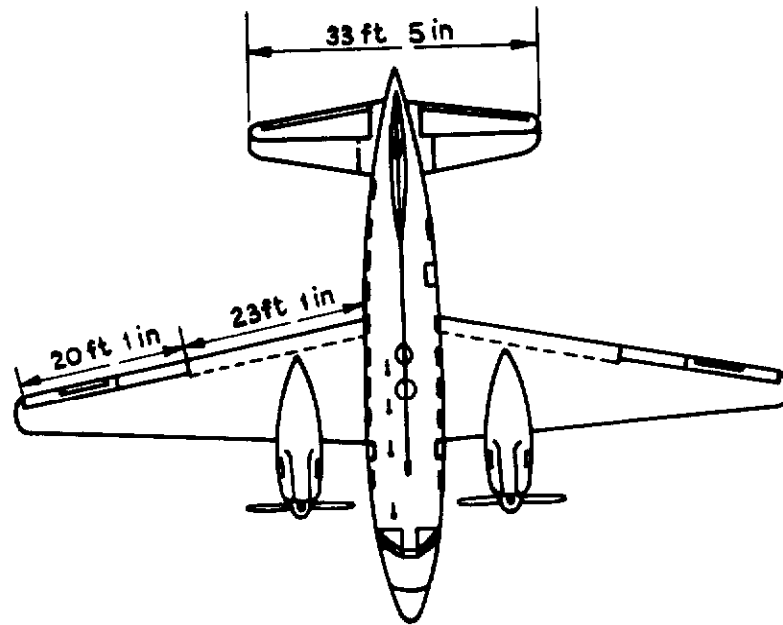

Fig.1 Vickers Varsity T Mk I

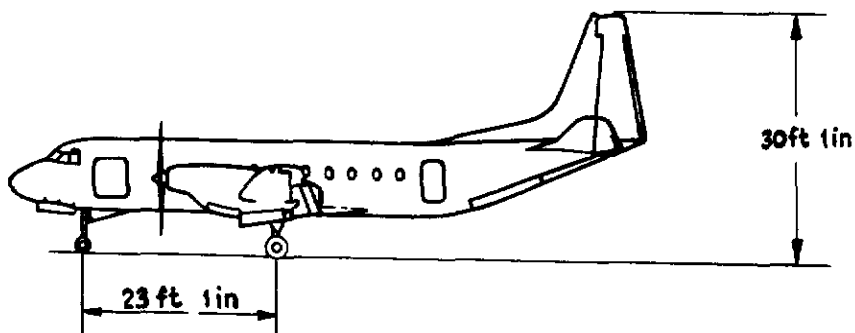
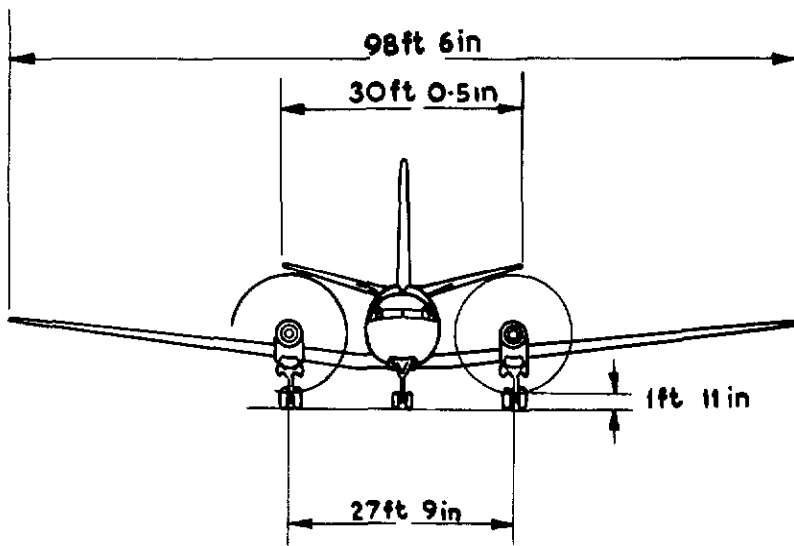
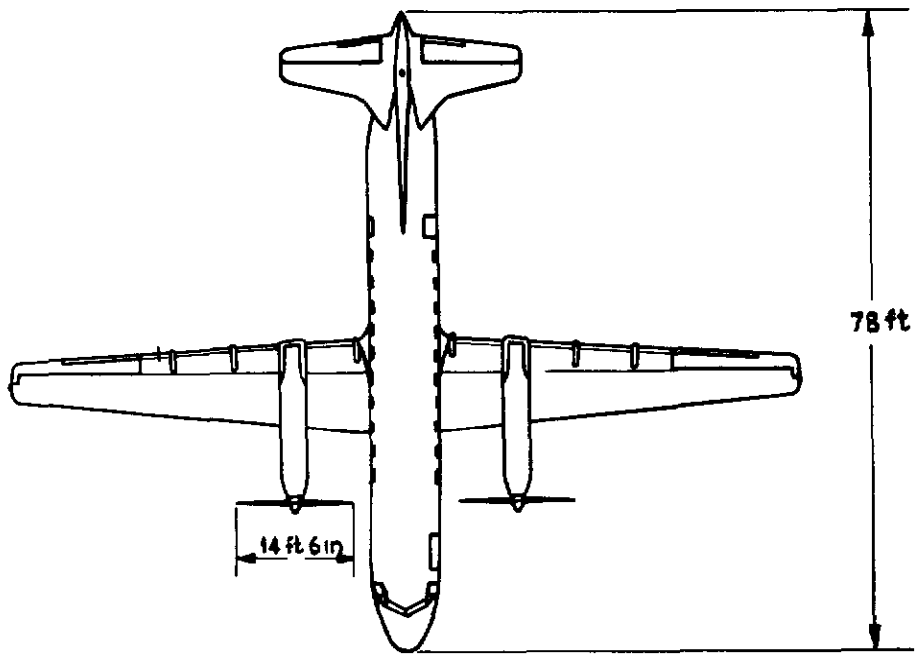

Fig.2 Hawker Siddeley Andover C Mk I



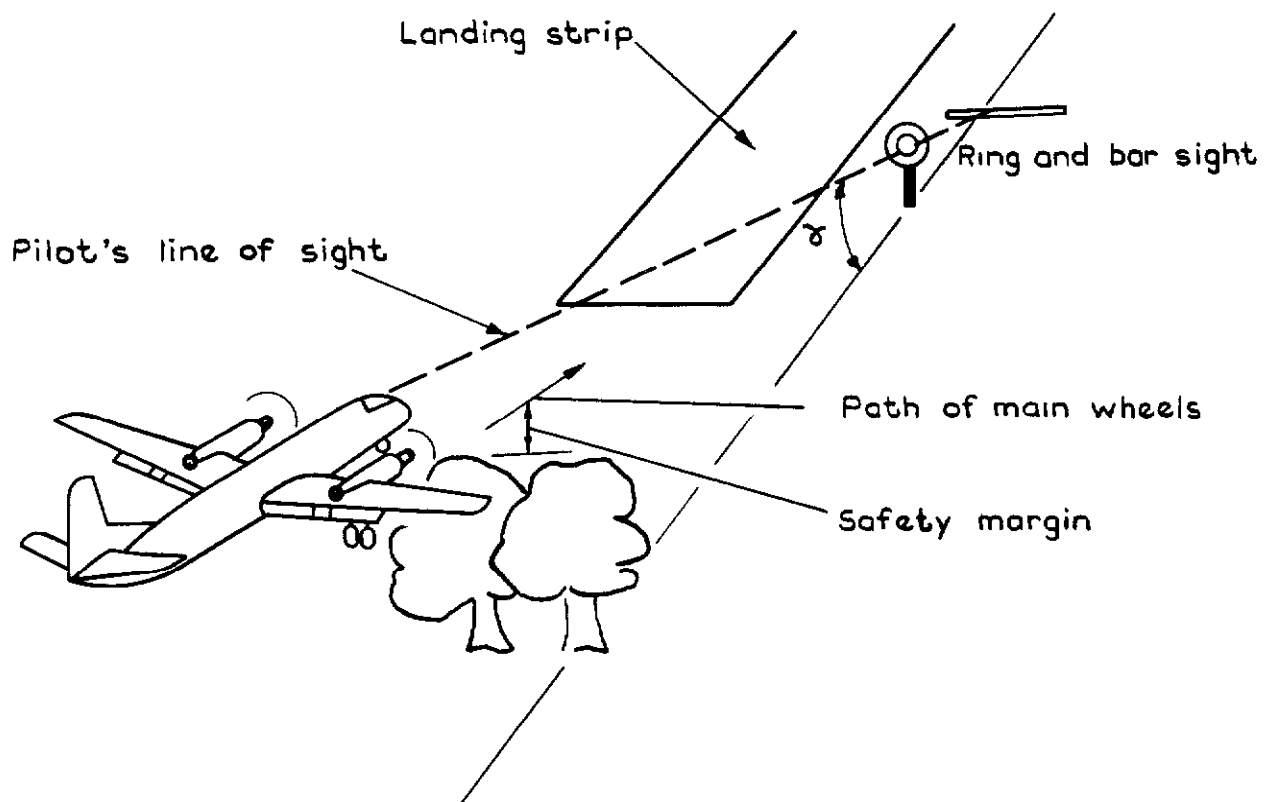

Fig.3 Approach over an obstacle using a ring and bar sight



Fig 4. Simulated barrier used for Varsity trials

08 14 18 42 52 60 1:2 1:6

14 3 42 52 58 1.2 1.6



**Fig 5. Andover approaching over vertical water jet barrier**

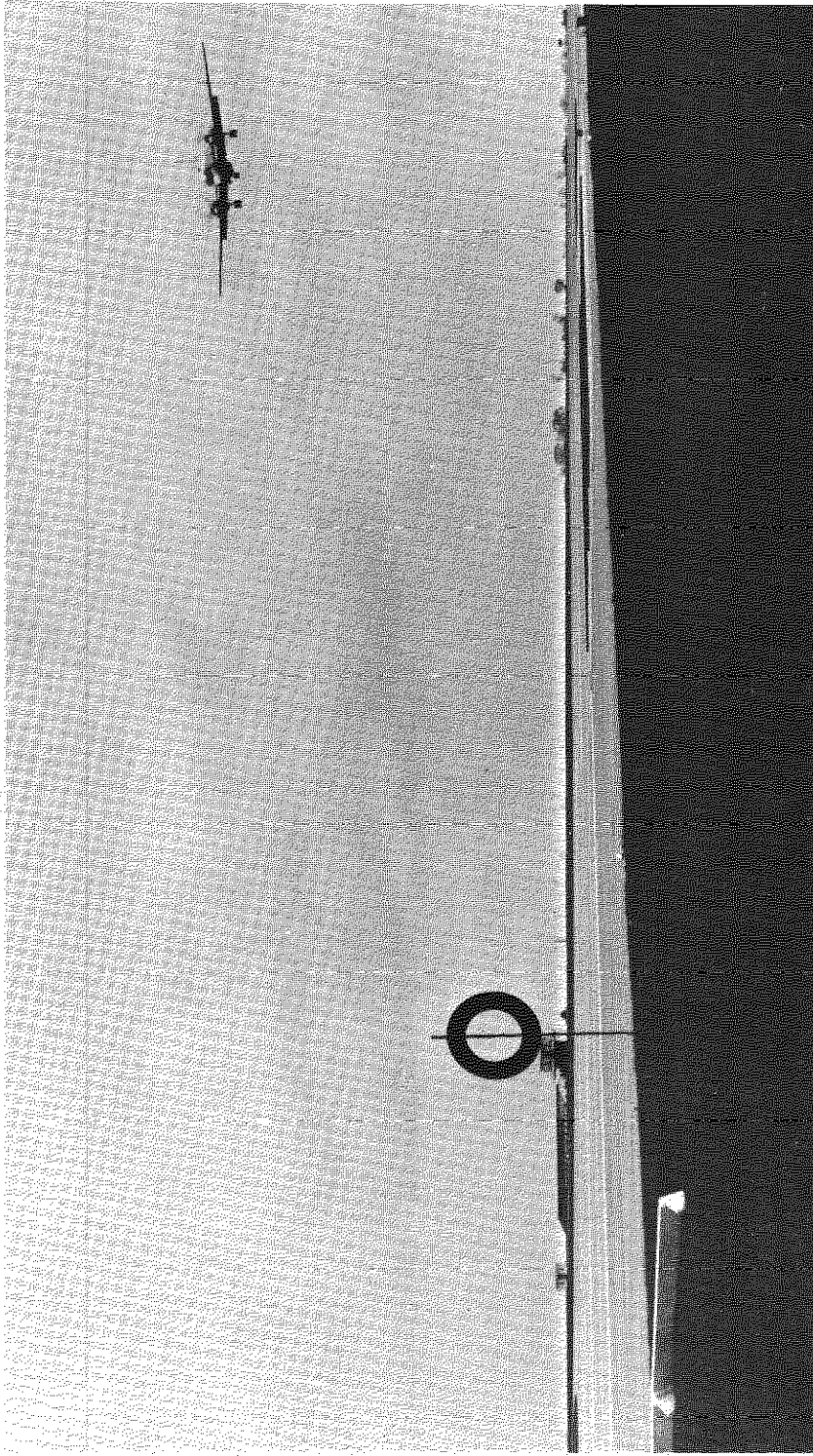

Fig 6. Ring and bar sight used for glide path guidance

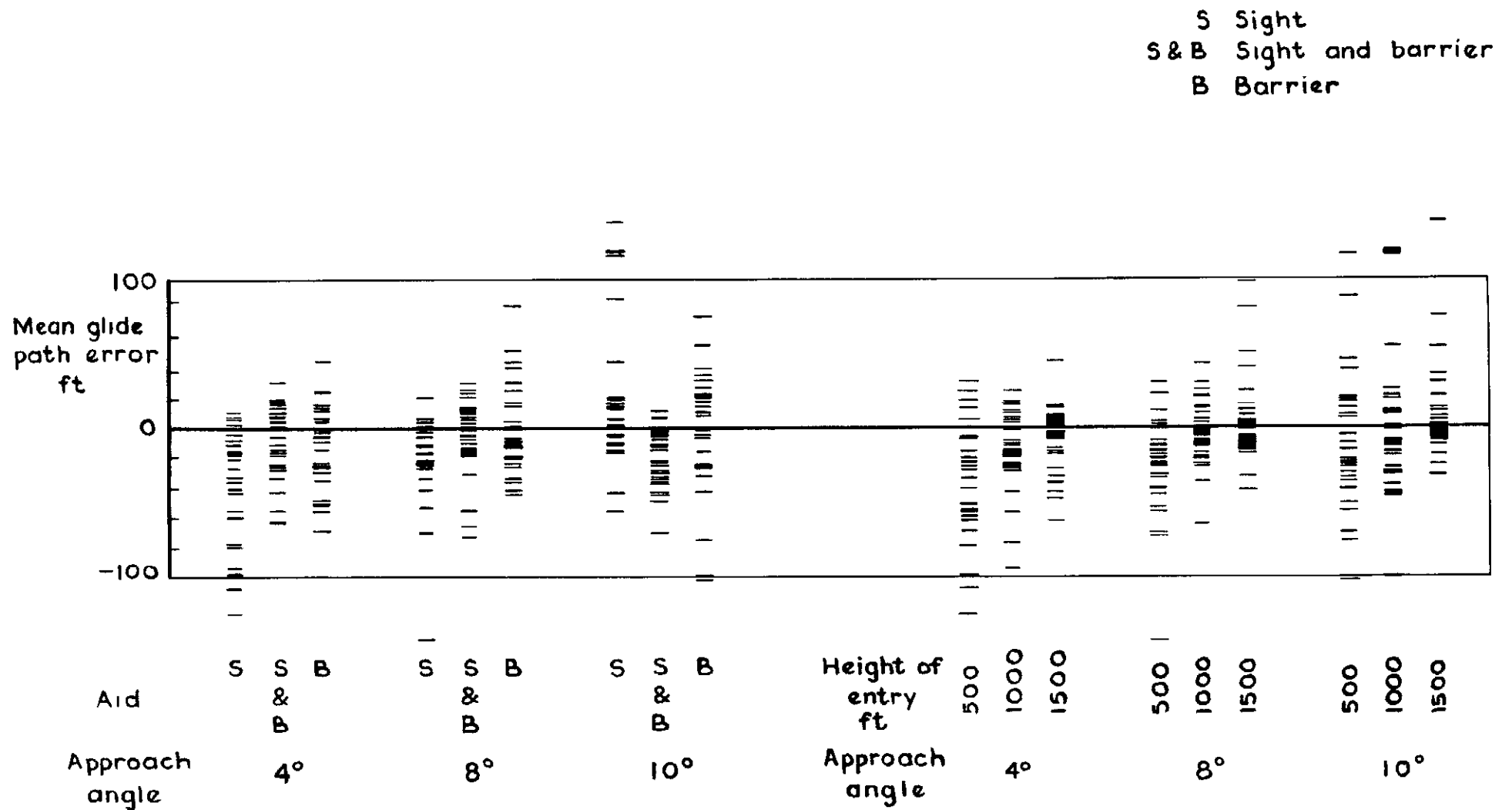

Fig.7 Significant effects on mean glide path error (Varsity)

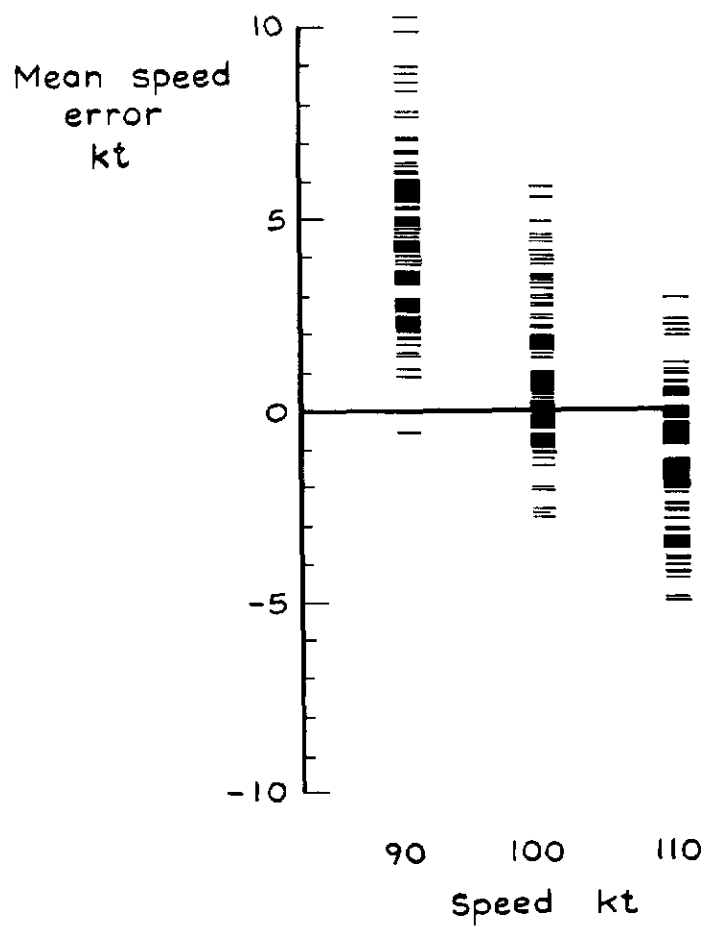

Fig 8 Significant effects on mean airspeed error on the approach (Varsity)

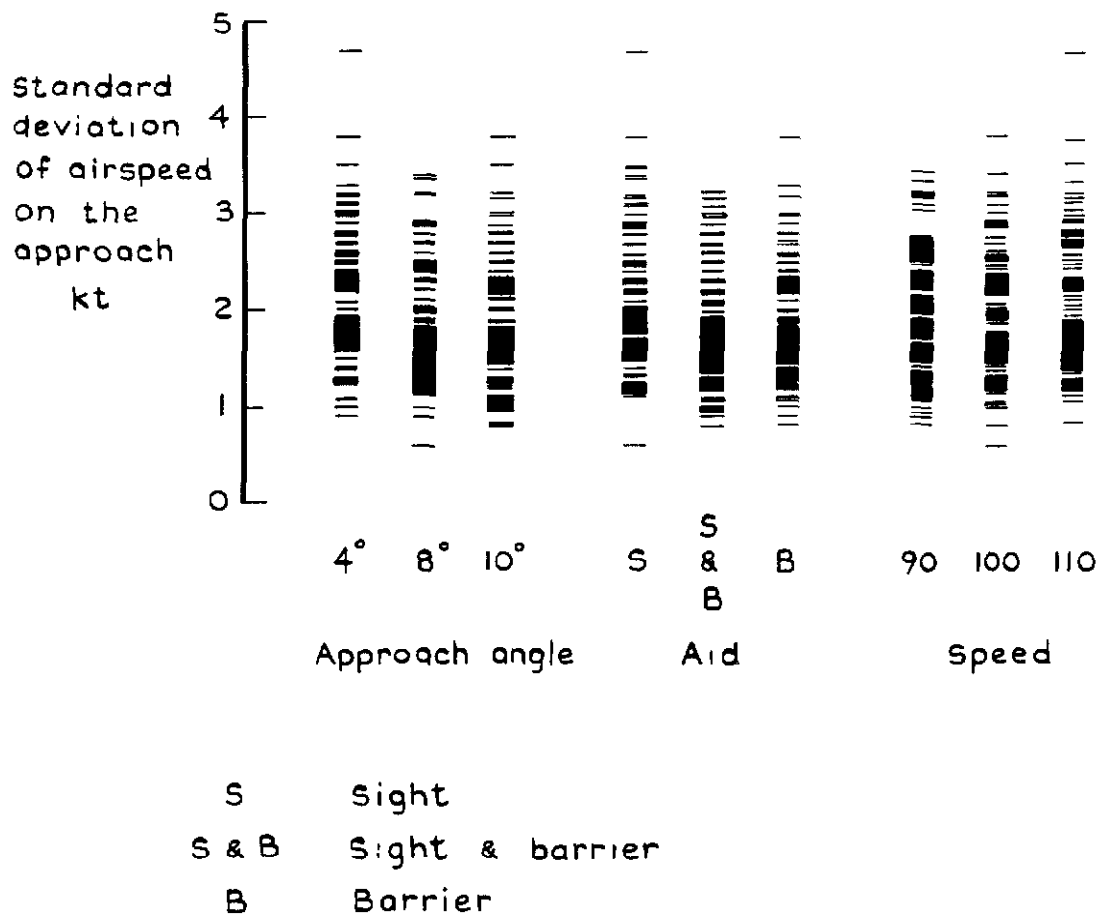

Fig 9 Significant effects on standard deviation of airspeed on the approach (Varsity)

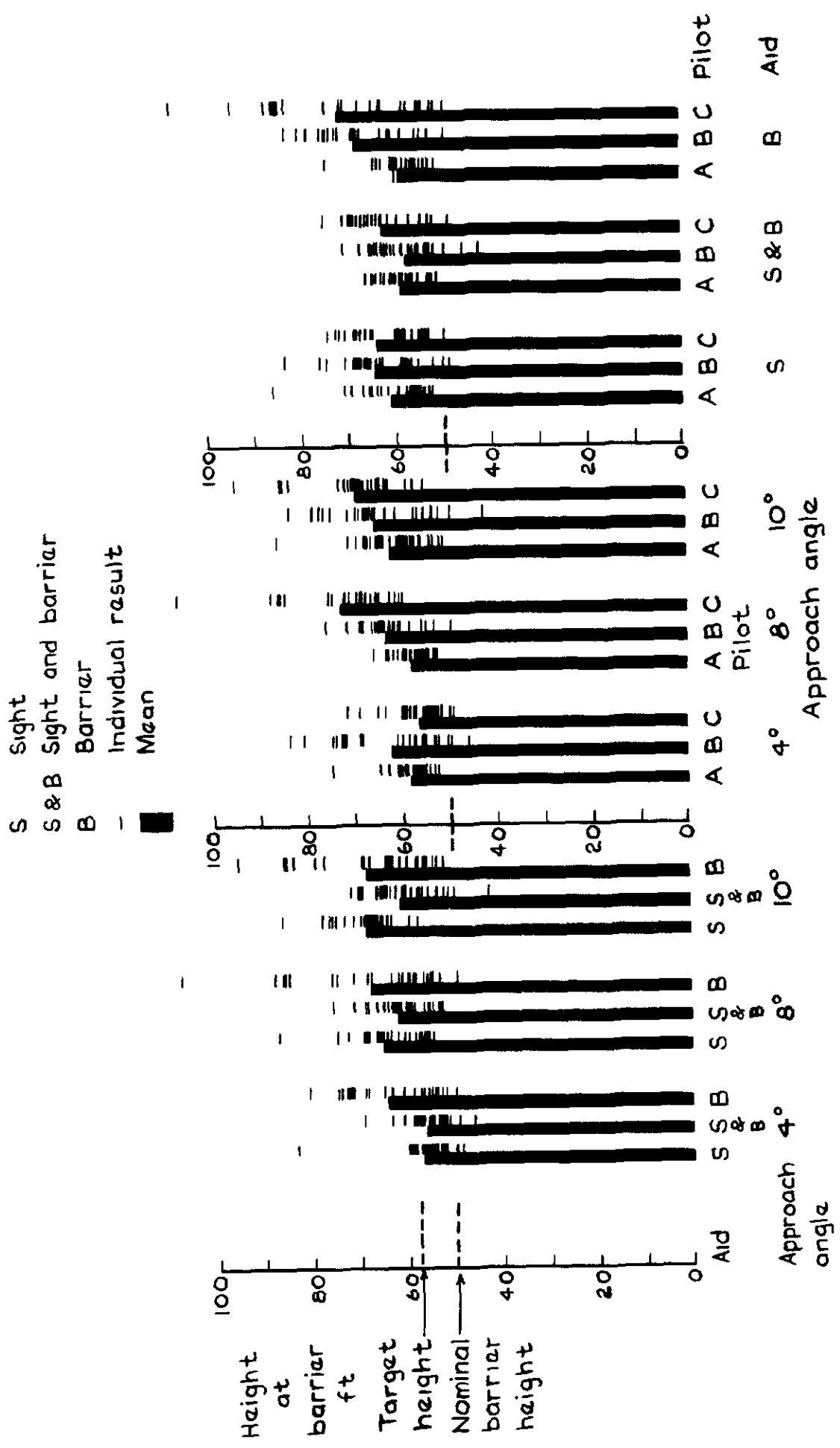

Fig. 10 Significant effects on height at the barrier (Varsity)



S Sight  
 S & B Sight and barrier  
 B Barrier  
 — Individual result  
 ■ Mean

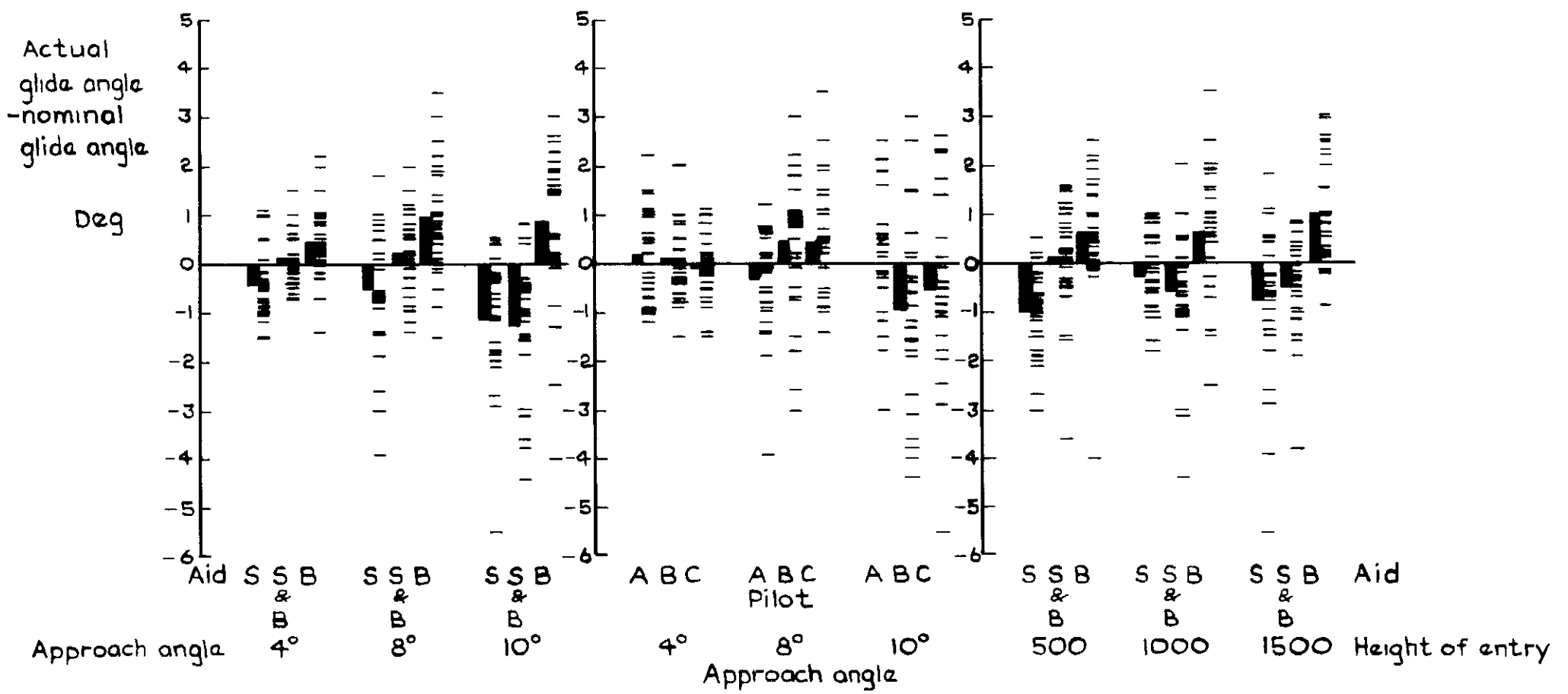

Fig. II Significant effects on the difference between actual and nominal glide slope angle at the barrier (Varsity)

S Sight  
 S & B Sight & barrier  
 B Barrier  
 - Individual result  
 ■ Mean

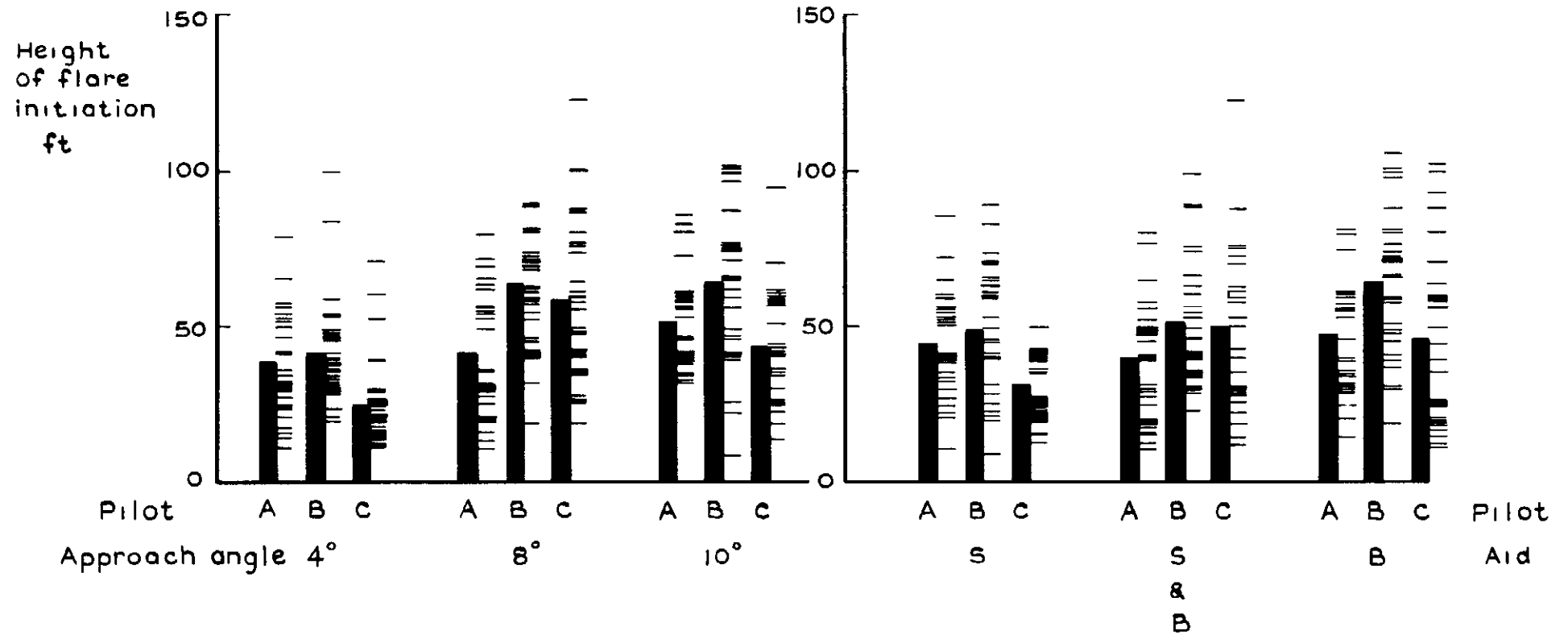

Fig.12 Significant effects on height of flare initiation (Varsity)

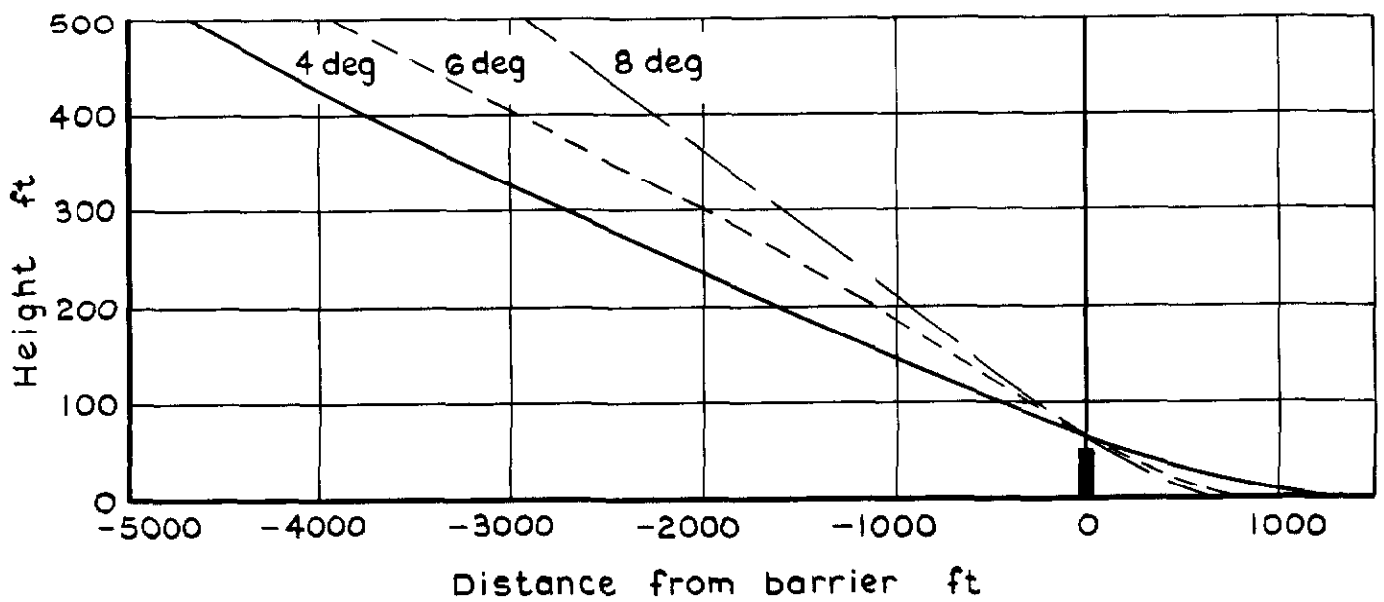
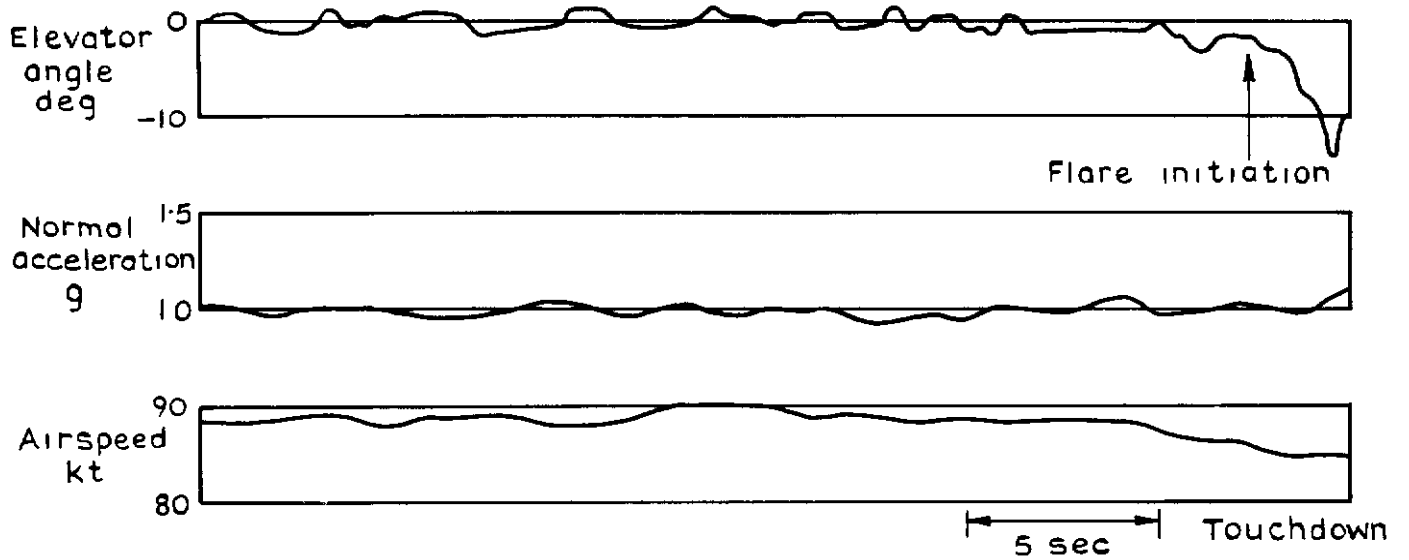
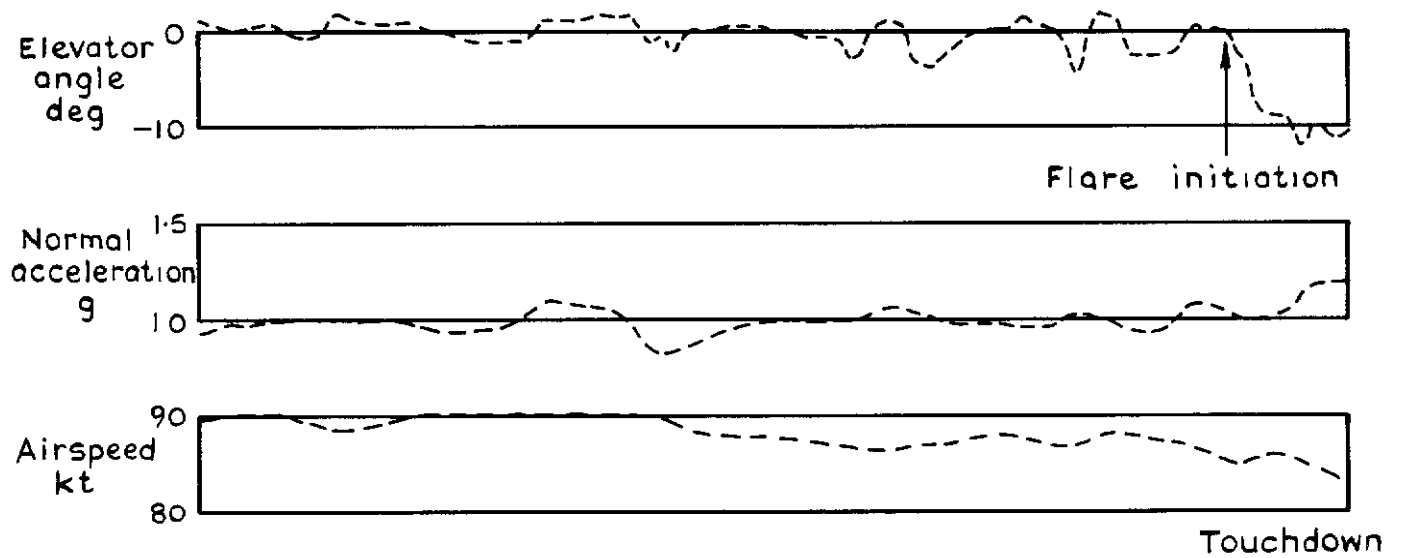

Fig.13 Typical flight paths for 4,6 and 8 deg approaches by the Andover using sight and barrier aids



a 4 deg approach



b 6 deg approach

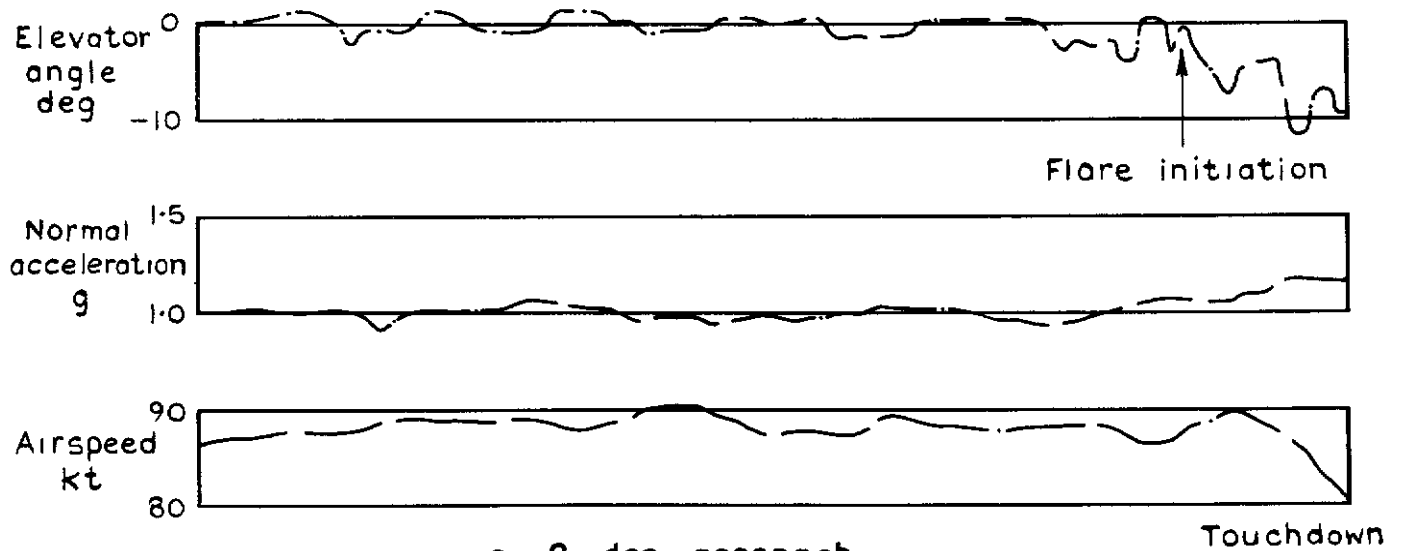

c 8 deg approach

Fig 14a-c Typical time histories of 4, 6 and 8 deg approaches by the Andover using sight and barrier aids



a 4 deg approaches

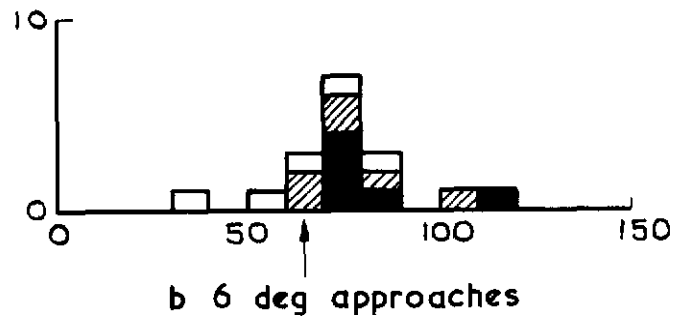

b 6 deg approaches

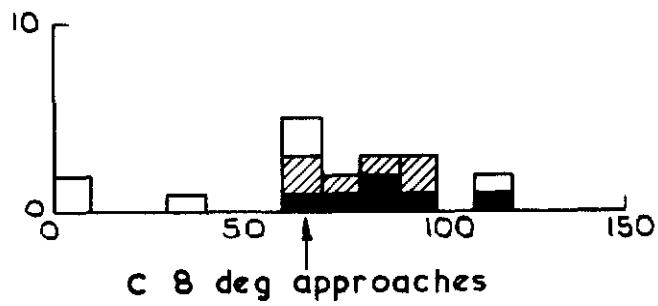

c 8 deg approaches

Fig.15 a-c Height at the barrier (Andover)

- Aiming point only
- ▨ Barrier and bar
- Barrier and sight

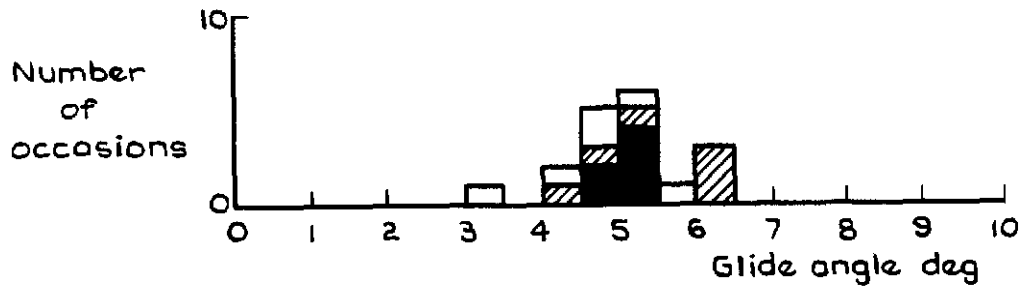

a 4 deg approaches

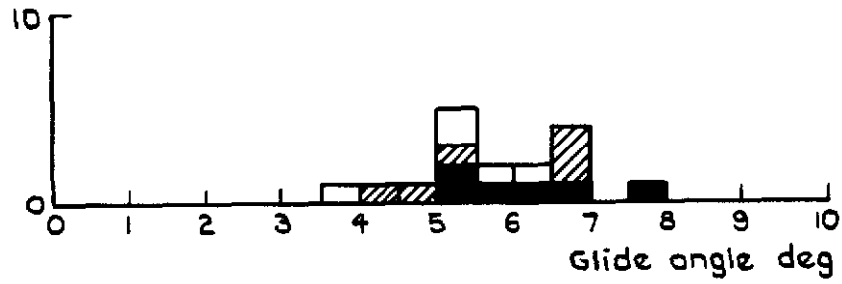

b 6 deg approaches

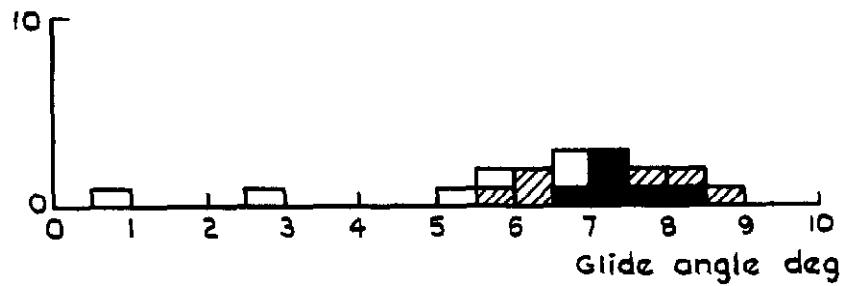

c 8 deg approaches

Fig.16a-c Glide angle at the barrier (Andover)

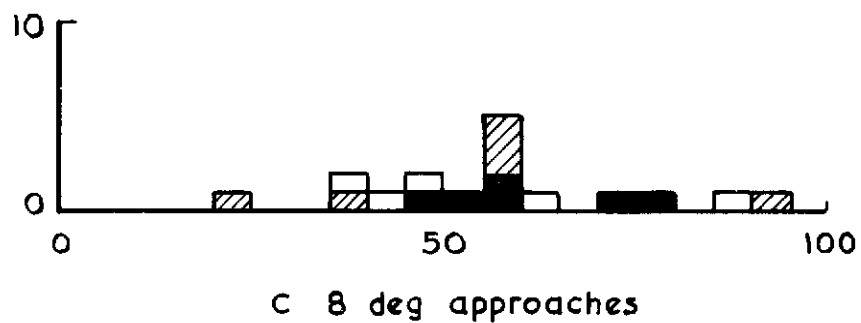
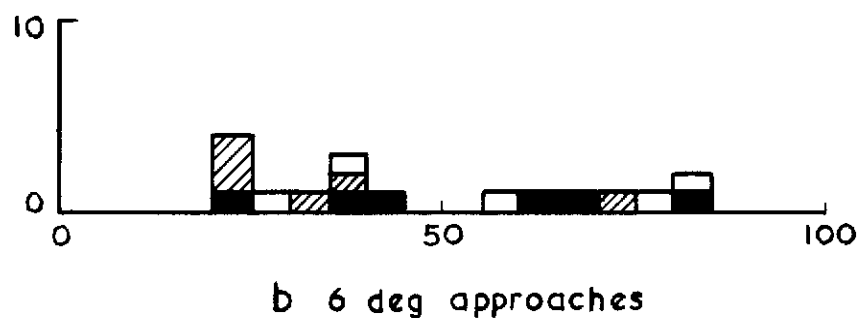
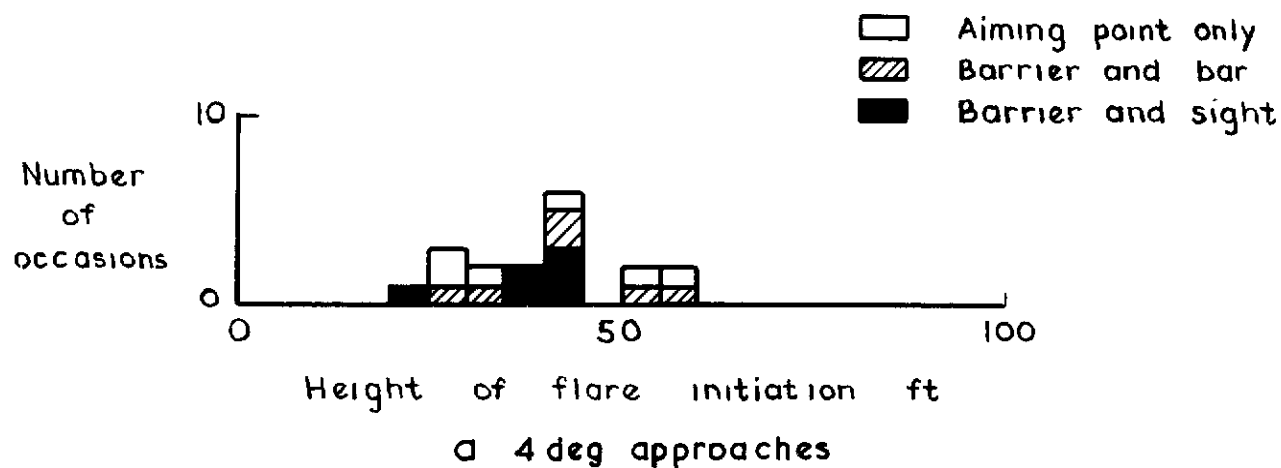
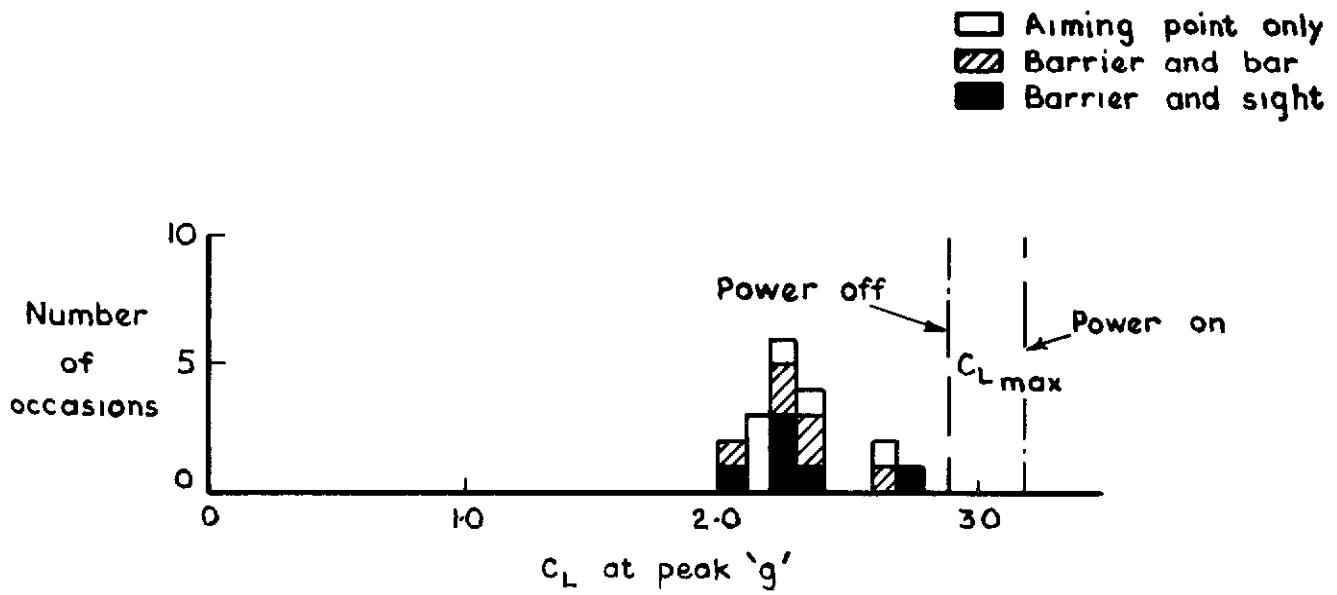
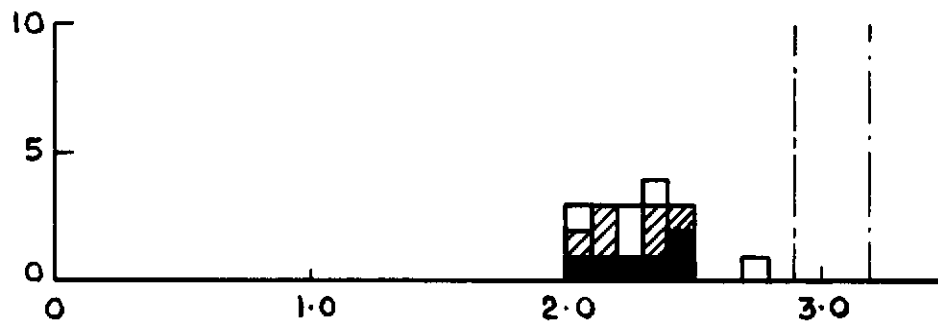

Fig.17 a-c Height of flare initiation (Andover)



a 4 deg approaches



b 6 deg approaches

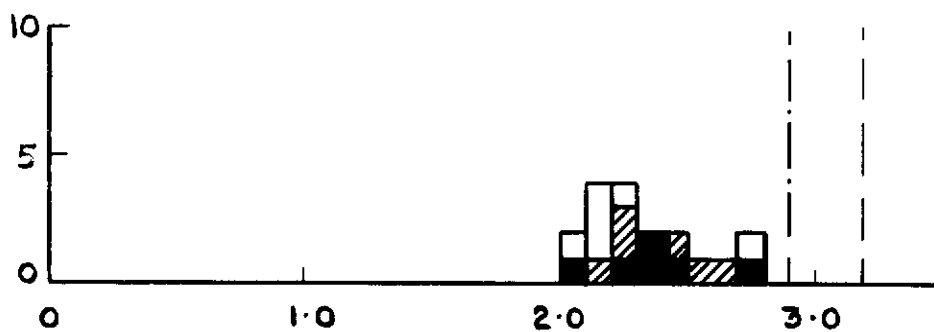

c 8 deg approaches

Fig.18 a-c  $C_L$  at peak 'g' (Andover)



- Aiming point only
- ▨ Barrier and bar
- Barrier and sight

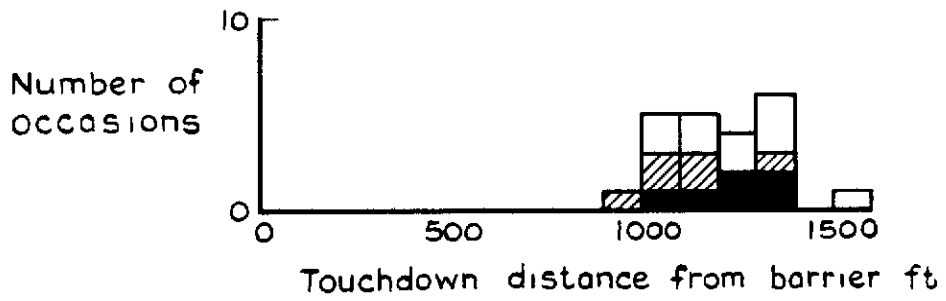

a 4 deg approaches

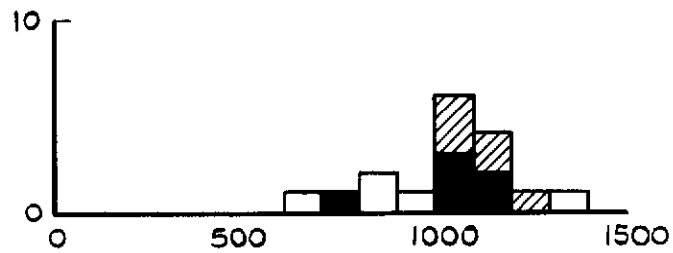

b 6 deg approaches

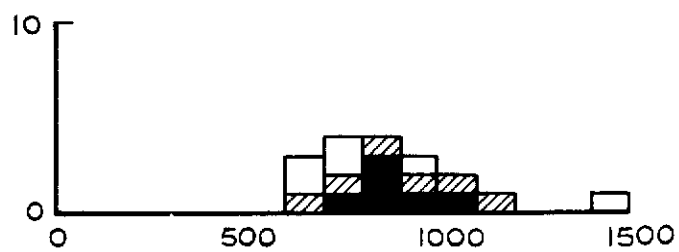

c 8 deg approaches

Fig.19 a-c Touchdown distance from the barrier  
(Andover)

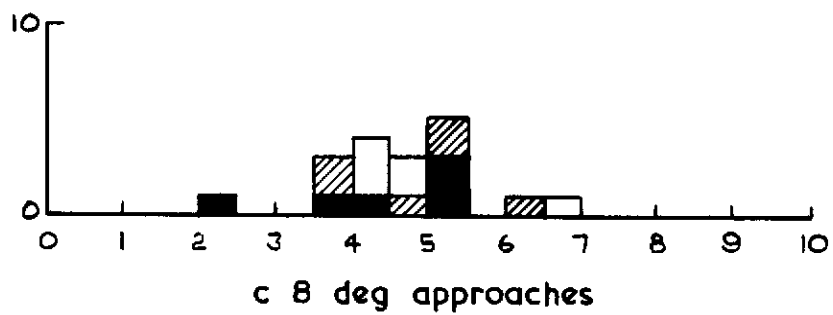
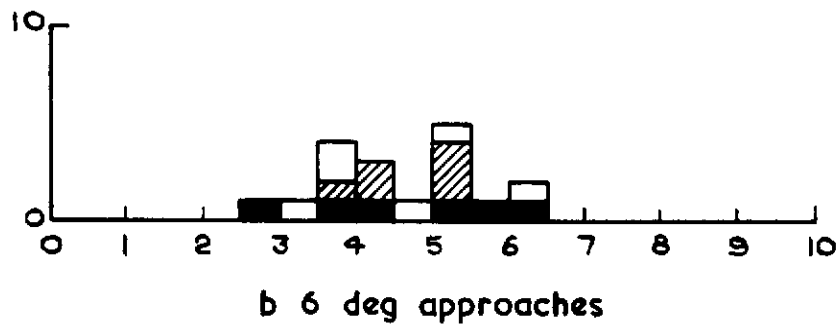
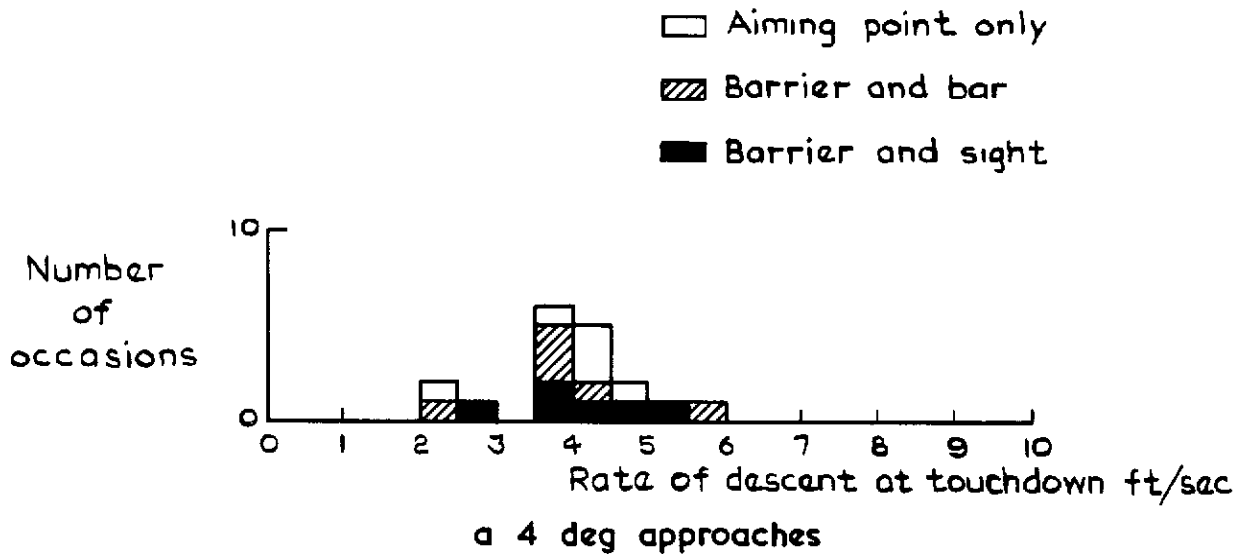

Fig 20a-c Rate of descent at touchdown (Andover)

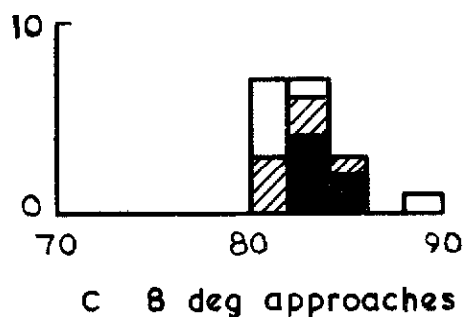
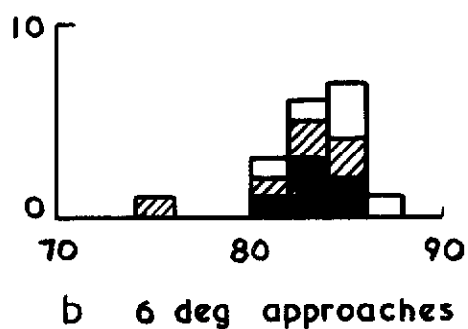
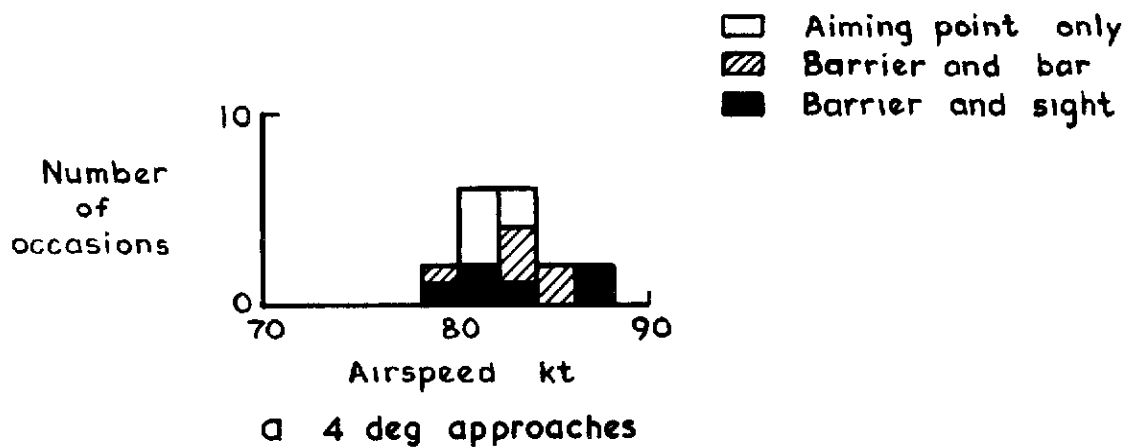

Fig.21 a-c Airspeed at touchdown (Andover)



DETACHABLE ABSTRACT CARD

A.R.C. CP. No.1138  
December 1969

629.13.087 :  
629.136-118

O'Leary, C.O.  
Slatter, N.V.

FLIGHT TESTS TO INVESTIGATE THE PROBLEMS OF STEP APPROACHES BY STOL AIRCRAFT

Step approach tests with a Varsity and an Andover aircraft are described. Using the Varsity aircraft, 243 visual approaches were flown in a statistical experiment which included variations of approach angle, speed, height of entry to the approach, glide path guidance and pilots. A statistical analysis of the effects of the variables on various approach performance parameters was carried out and the significant results are illustrated and discussed. Tests with the Andover aircraft were on a smaller scale and were primarily concerned with the final phase of the approach and landing.

(Over)

A.R.C. CP. No.1138  
December 1969

629.13.087 :  
629.136-118

O'Leary, C.O.  
Slatter, N.V.

FLIGHT TESTS TO INVESTIGATE THE PROBLEMS OF STEP APPROACHES BY STOL AIRCRAFT

Step approach tests with a Varsity and an Andover aircraft are described. Using the Varsity aircraft, 243 visual approaches were flown in a statistical experiment which included variations of approach angle, speed, height of entry to the approach, glide path guidance and pilots. A statistical analysis of the effects of the variables on various approach performance parameters was carried out and the significant results are illustrated and discussed. Tests with the Andover aircraft were on a smaller scale and were primarily concerned with the final phase of the approach and landing.

(Over)

(Over)

Step approach tests with a Varsity and an Andover aircraft are described. Using the Varsity aircraft, 243 visual approaches were flown in a statistical experiment which included variations of approach angle, speed, height of entry to the approach, glide path guidance and pilots. A statistical analysis of the effects of the variables on various approach performance parameters was carried out and the significant results are illustrated and discussed. Tests with the Andover aircraft were on a smaller scale and were primarily concerned with the final phase of the approach and landing.

FLIGHT TESTS TO INVESTIGATE THE PROBLEMS OF STEP APPROACHES BY STOL AIRCRAFT

O'Leary, C.O.  
Slatter, N.V.

A.R.C. CP. No. 1138  
December 1969

629.13.087 :  
629.136-118

The most important results of the tests are that steep approaches can be accurately and consistently made using a simple form of glide path guidance and landing distances can be decreased without any apparent increase in variability of performance.

The most important results of the tests are that steep approaches can be accurately and consistently made using a simple form of glide path guidance and landing distances can be decreased without any apparent increase in variability of performance.

The most important results of the tests are that steep approaches can be accurately and consistently made using a simple form of glide path guidance and landing distances can be decreased without any apparent increase in variability of performance.



C.P. No. 1138

© *Crown copyright 1970*

Published by

HER MAJESTY'S STATIONERY OFFICE

To be purchased from

49 High Holborn, London WC1

13a Castle Street, Edinburgh EH2 3AR

109 St Mary Street, Cardiff CF1 1JW

Brazenose Street, Manchester 2

50 Fairfax Street, Bristol BS1 3DE

258 Broad Street, Birmingham 1

7 Linenhall Street, Belfast BT2 8AY

or through any bookseller

C.P. No. 1138

SBN 11 470386 8