

N. A. R.

R. & M. No. 2562
(5344)
A.R.C. Technical Report



MINISTRY OF SUPPLY

AERONAUTICAL RESEARCH COUNCIL
REPORTS AND MEMORANDA

Tests on the Hurricane L.1696
in the 24-ft Wind Tunnel

By

D. W. BOTTLE, B.Sc., and T. V. SOMERVILLE, B.Sc.

Crown Copyright Reserved

LONDON: HER MAJESTY'S STATIONERY OFFICE

1953

THREE SHILLINGS NET

Tests on the Hurricane L.1696 in the 24-ft Wind Tunnel

By

D. W. BOTTLE, B.Sc., and

T. V. SOMERVILLE, B.Sc.

COMMUNICATED BY THE PRINCIPAL DIRECTOR OF SCIENTIFIC RESEARCH (AIR),
MINISTRY OF SUPPLY

*Reports and Memoranda No. 2562**

August, 1941

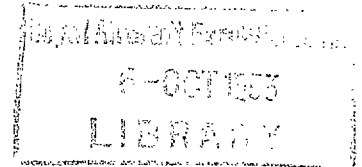

Summary.—Reasons for Enquiry.—Tests on a *Hurricane* in the 24-ft Wind Tunnel at the Royal Aircraft Establishment were required to find if any simple modifications could be made which would reduce its drag.

Range of Investigation.—Measurements were made of :—

- (1) Leak drag.
- (2) Drag of miscellaneous excrescences.
- (3) Cooling drag.
- (4) Drag of the tail unit.

Conclusions.—The tests showed that the leak drag plus the drag due to the control gaps was 13 per cent of the total profile drag of the aircraft. Of this leak drag only one-third could be eliminated by methods which could be incorporated in production aircraft without serious modification. This emphasises the importance of eliminating leaks in the design stage.

The drag of the cooling system was reasonably low, and tail-fuselage interference was small.

1. *Introduction.*—Tests have been made in the 24-ft Wind Tunnel at the Royal Aircraft Establishment, on a *Hurricane* to find if simple modifications can be introduced which will decrease its drag. The tests included measurements of the drag due to leaks, the drag of miscellaneous excrescences, the cooling drag and the drag of the tail unit. The results of tests to measure the wing-root interference^{1,2} and to compare standard and Galloway-type radiators³ have already been reported.

2. *Description of Aircraft as Tested.*—The *Hurricane* L.1696, which is one of the first production aircraft, was used for the tests. The aircraft was fitted with fabric-covered wings and streamline-type exhausts. Dimensions and particulars of the aircraft are given in Table 1, and Figs. 1 and 2 show general views.

For the purpose of the tests in the 24-ft tunnel a pylon and tail strut replaced the undercarriage and tail wheel. The compartment into which the undercarriage retracts is partially closed by doors attached to the undercarriage, and this compartment was fitted with similar doors to represent the retracted condition.

* R.A.E. Report No. B.A.1697, received 2nd October, 1941.

The tests were made without propeller, this being replaced by a spinner simulating the propeller hub (Fig. 3). Machine guns were fitted so that leaks at the gun holes in the wing leading edge or at the cartridge chutes would correspond to service conditions.

The drag differences quoted are mean values derived from tests at 100 and 140 ft/sec at a wing-root incidence of 2.8 deg. At this incidence the lift coefficient of that part of the wing in the tunnel was approximately equal to the lift coefficient of the complete aircraft at top speed. The tests were made in July, 1939.

3. *Results.*—3.1. *Leak Drag.*—The drag due to leaks was found by sealing all leaks and measuring the drag as groups of leaks were unsealed. The reduction in drag obtained was as follows:—

	<i>Reduction of Drag in lb at 100 ft/sec</i>
1. Completely sealing all leaks, including sealing and fairing gaps at control surfaces and flaps.	10.8
2a. Sealing all leaks which the manufacturers considered practicable from the point of view of construction and maintenance of the aircraft, including gun slots and cartridge chutes (<i>see</i> Table 2).	3.4
2b. As for 2a but gun slots and cartridge chutes open	3.0

Several drag readings were also taken during the process of unsealing from the completely sealed condition (case 1) to the practical sealed condition (case 2b). The results obtained are given in Table 3. It should be pointed out that any other sequence might give different values for the drag saved by sealing individual leaks, though the overall results between the two cases would be the same.

3.2. *Miscellaneous Drag Items.*—Measurements were made of the drag of several individual parts of the aircraft which could be readily removed.

The results obtained were:—

Drag of venturi	1.7 lb at 100 ft/sec
Drag of streamline-type exhausts	2.8 lb at 100 ft/sec

The drag of the exhaust system includes the leak drag associated with the gap between the exhaust manifold and the engine cowling.

The change in drag due to substituting a larger spinner, as detailed in Fig. 3 suitable for a two-pitch metal propeller, was also measured.

Reduction in drag due to replacing wooden propeller spinner with two-pitch metal propeller spinner. 1.1 lb

Further reduction on sealing metal propeller spinner gap 0.8 lb

The drag saved on sealing the spinner gap of the wooden propeller (*see* Table 3, item 8) was 1.7 lb, hence with spinner gap sealed the drag of the aircraft would be the same with either spinner, which indicates that the reduction in drag due to fitting the larger spinner is due to a decrease in the leak drag at the spinner gap. The drag of the air intake with entry faired and sealed was 4 lb. It was thought that this might be reduced by fitting a fairing at the back of the air intake, as the shape was rather bluff, but this only effected a reduction of 0.3 lb. The figure of 4 lb was obtained by removing the air intake after the radiator had already been removed. Replacing the air intake when the radiator was present only increased the drag of the aircraft 1.8 lb. There must therefore have been a beneficial mutual interference between the air intake and the radiator of 2.2 lb. This was checked when the radiator drag was measured.

3.3. *Cooling Drag*.—Engine cooling is provided by a radiator mounted in the ventral position aft of the air intake as shown in Fig. 1. The general arrangement of the radiator and cowl is shown in Fig. 4 and details of the matrix are given in Table 1.

Air Intake Removed.—The presence of the air intake just upstream of the radiator appreciably affects the total head at the duct inlet, and therefore tests were first made with the air intake removed. Under these conditions the entry total head at the radiator was 0.94 of $\frac{1}{2}\rho V^2$, and with the louver in the neutral position the flow was 78 cu ft/sec.

The drag analysis at 100 ft/sec is—

Minimum internal drag	5.0 lb
Residual internal drag	1.0 lb
External cooling drag	1.8 lb
Total cooling drag	7.8 lb

For the same flow this roughly agrees with model tests⁴ made on a similar radiator cowl with a reduced duct exit area.

The full results for the louver in various positions are given in Table 5 and Fig. 5.

With Air Intake.—With the air intake in position and sealed by a nose fairing the entry total head is reduced to 0.82 of $\frac{1}{2}\rho V^2$, and the flow with the louver in the neutral position is decreased to 76 cu ft/sec. Owing to the mutual interference between the air intake and the radiator the separation of the total drag of radiator plus air intake into cooling drag and air intake is purely artificial.

Thus although the drag of the intake alone is 4 lb as given in section 3.2, the total drag of the intake plus radiator is only 9.6 lb, *i.e.*, the radiator drag by difference is 5.6 lb against 7.8 lb when tested without air intake.

It seems probable from this that the radiator improves the flow round the intake, and this would explain why a fairing behind the intake only decreases the drag by 0.3 lb when the radiator is in position.

With no nose fairing on the air intake the radiator entry total head is reduced to 0.59 of $\frac{1}{2}\rho V^2$, and the flow with the louver in the neutral position is decreased to 65 cu ft/sec. No drag measurements were made in this case, and subsequent flow tests with engine running showed that the condition with the nose fairing on the air intake corresponds more nearly to the case when the air is entering the intake.

Gun Heaters in Position.—In the machine as flown, two ducts with entries just downstream of the radiator lead warm air to the guns. With these in position an increase in drag of 0.9 lb at 100 ft/sec is obtained, but they cause no measurable change in the cooling flow through the matrix. Thus with the machine as flown the total drag of the radiator system plus air intake at 100 ft/sec is—

Minimum internal cooling drag	4.7 lb
Residual internal + external cooling drag + air intake drag	4.9 lb
Drag of gun heaters	0.9 lb
Total	10.5 lb

3.4. *Drag of the Tail Unit*.—Figures for the drag of the tail unit were obtained by measuring the differences in lift and drag when the tailplane and elevators and the complete tail unit were removed, and the aft end of the fuselage faired. The measurements were made at a C_L of 0.16 with the elevators in the neutral position, which corresponds roughly with the trimmed conditions

at top speed, and the drag readings were corrected for the local speed and static pressure gradient at the position of the tail unit in the tunnel. The induced drag of the tail unit estimated from the tail lift was found to be very small and could be neglected.

The results obtained were—

Profile drag of tailplane + elevators	4 lb at 100 ft/sec
Profile drag of fin + rudder	2 lb at 100 ft/sec

These figures agree with the estimated⁵ profile drag of the tail unit at the speed of the test. This is in agreement with other tests⁶ which indicated that the fuselage-tail interference drag is negligible.

4. *Conclusions.*—The tests have shown that leak drag on the *Hurricane* L.1696 is an appreciable percentage of the total profile drag (9 per cent assuming control gaps 4 per cent) and that, in the present stage of production, considerations of construction and maintenance only allow one third of this leak drag to be avoided. This emphasises the importance of eliminating leaks in the design stage. The drag of the cooling system is reasonably low, and tail-fuselage interference is small.

REFERENCES

No.	Author.	Title, etc.
1	Bottle	Interim Note on the Measurement of Wing Root Interference by the Momentum Method. A.R.C. 4315. December, 1939. (Unpublished.)
2	Buxton	Interim Note on the Measurement of Wing Root Interference with Slipstream on the Hurricane. A.R.C. 4601. May, 1940. (Unpublished.)
3	Reeman	Tests in the 24-ft Tunnel on an Experimental Gally Aerodynamic Radiator Fitted to a Hurricane. A.R.C. 5358. November, 1940. (Unpublished.)
4	Shaw and Cameron	Model Tests of the Hawker Interceptor Radiator Cowl. R.A.E. Report No. B.A.1298. May, 1936 and addendum B.A.1298(a) August, 1936.
5	Squire and Young	The Calculation of the Profile Drag of Aerofoils. R. & M. 1838. November, 1937.
6	Sherman	Interference of Tail Surfaces and Wing and Fuselage from Tests of 17 Combinations in the N.A.C.A. Variable Density Tunnel. N.A.C.A. Report No. 678. 1939.

TABLE 1

*Hurricane L.1696—General Particulars*1. *Dimensions of aircraft*

Length	31.4 ft
Span	40 ft
Wing area, gross	257 sq ft
Wing area in tunnel jet, gross	183 sq ft

2. *Surface areas*

Wings	463 sq ft
Body	312 sq ft
Tail	110 sq ft
Total	484 sq ft

3. *Performance data*

Engine Merlin II	1,020 b.h.p.
All-up weight	5,730
Exhausts	Streamlined
Top speed at 17,500 ft	301 m.p.h.

4. *Radiator*

7 × 320 mm hexagonal tubes

Total matrix area	2.20 sq ft
Glycol matrix area	1.91 sq ft
Oil matrix area	0.29 sq ft
Entry area	1.17 sq ft
Exit area flaps neutral	1.19 sq ft
Radiator flap chord	13.85 in.
Radiator flap	18 in.

TABLE 2

List of Leaks considered Practical to Seal from the Point of View of Construction and Maintenance

1. Leak from spinner gap into engine compartment sealed by forward diaphragm.
2. Starter handle holes.
3. Gap between air intake and cowling.
4. Tailwheel leak, and leaks at stern post. Sealed by fabric bulkhead in fuselage just forward of tail.
5. Leak at radiator flap control rods.
6. Leak aft of sliding cockpit cover.
7. Holes for landing flares.
8. Undercarriage wheel well. Not sealed by fairing, but leaks from well into fuselage and wings sealed.
9. Internal leaks :
 - (a) Sealing fireproof bulkhead isolates engine compartment from fuselage.
 - (b) Sealing fabric bulkhead at wing roots isolates wings from fuselage.
 - (c) Sealing gap inside wing-root fillet at leading edge isolates wing from engine compartment.

TABLE 3
Decrease of Drag Due to Sealing Leaks

Datum : Aircraft as received, but air-intake entry and exhaust exits faired and sealed.

No.	Modification	Drag saved at 100 ft/sec
1	Sealing all leaks considered practical from the point of view of construction and maintenance	3.0 lb
2	Effect of sealing leaks at rear of cockpit cover	0
3	Seams and other leaks in fuselage forward of tail wheel and aft of engine bulkhead sealed. Rudder and elevator gaps faired and leaks sealed	3.5 lb
4	Undercarriage wheel well faired and sealed	2.0 lb
5	Leaks forward of engine bulkhead sealed, including seams and leaks between exhausts and cowling	1.8 lb
6	Wings sealed, including guns and cartridge chutes, seam leaks, flaps and drain holes ..	0.5 lb
	Total leak drag ; datum aircraft completely sealed	10.8 lb

Drag of Individual Leaks (included above)

Datum : Aircraft as received.

7	Gun slots at wing leading edge and cartridge chutes sealed	0.4 lb
8	Gap at airscrew spinner sealed	1.7 lb

TABLE 4
Drag of Miscellaneous Modifications

Datum : Condition of aircraft as received.

No.	Modification	Drag saved at 100 ft/sec
9	Venturi removed	1.7 lb
10	Exhausts removed and cowling faired and sealed	2.8 lb
11a	Replacing spinner with larger spinner for two-pitch metal airscrew	1.1 lb
b	Sealing spinner gap	0.8 lb
12	Air intake (without tail) removed. Radiator absent	4.0 lb
13	Fairing tail added to air intake. Radiator in position	0.3 lb
14	Air intake (without tail) removed. Radiator in position	1.8 flaps 0 deg 1.4 flaps 15 deg
15	Removing gun heaters from radiator	0.9 lb

TABLE 5

Drag of Radiator and Cooling Flow at 100 ft/sec

Air intake and gun heaters removed.

Louvre angle, deg	Cooling flow, cu ft/sec	Entry total head	Total head aft of radiator	Total head at radiator exit	Minimum internal drag	Internal drag	External drag	Cooling drag
— 20	67	0.94	0.56	0.51	3.4 lb	4.5 lb	5.7* lb	10.2* lb
— 11	74	0.94	0.51	0.48	4.4	5.3	4.4*	9.7*
0	78	0.94	0.47	0.46	5.0	6.0	1.8	7.8
15	91	0.94	0.34	0.30	8.0	9.7	1.8	11.5

* With louvres recessed.

Drag of Radiator and Cooling Flow at 100 ft/sec

With air intake.

Condition of air intake	Louvre angle, deg	Cooling flow, cu ft/sec	Entry total head	Total head at radiator exit	Estimated minimum internal drag	Cooling drag
Nose fairing on the intake ..	—20	—	—	—	—	7.9
	—11	—	—	—	—	7.4
	0	76	0.82	0.33	4.7	5.6
	15	83	0.82	—	6.0	8.9
Nose fairing removed	0	65	0.59	0.25	2.9	—

Cooling drag is defined as : Drag of aircraft with radiator — drag of aircraft with radiator removed.

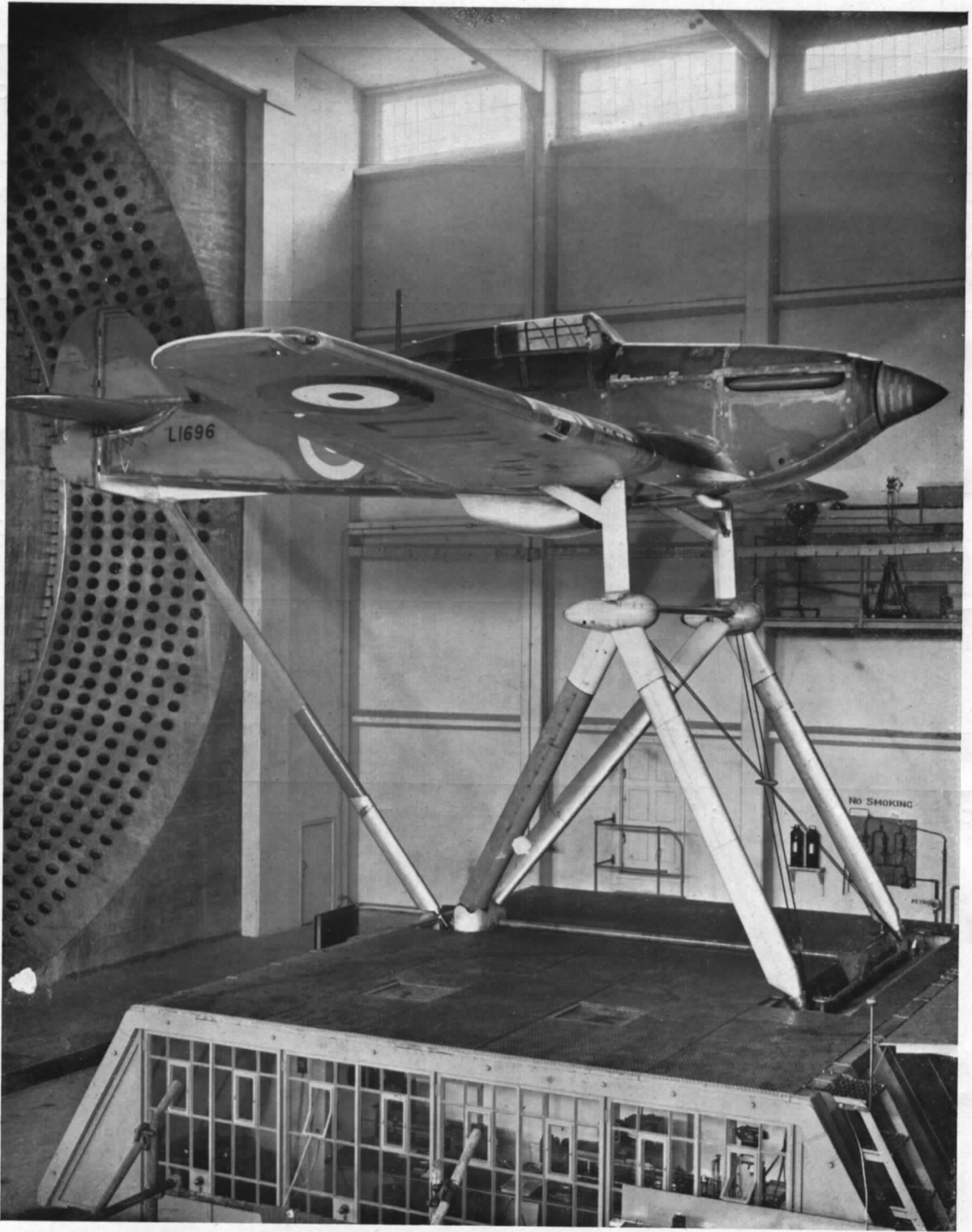

FIG. 1.

6

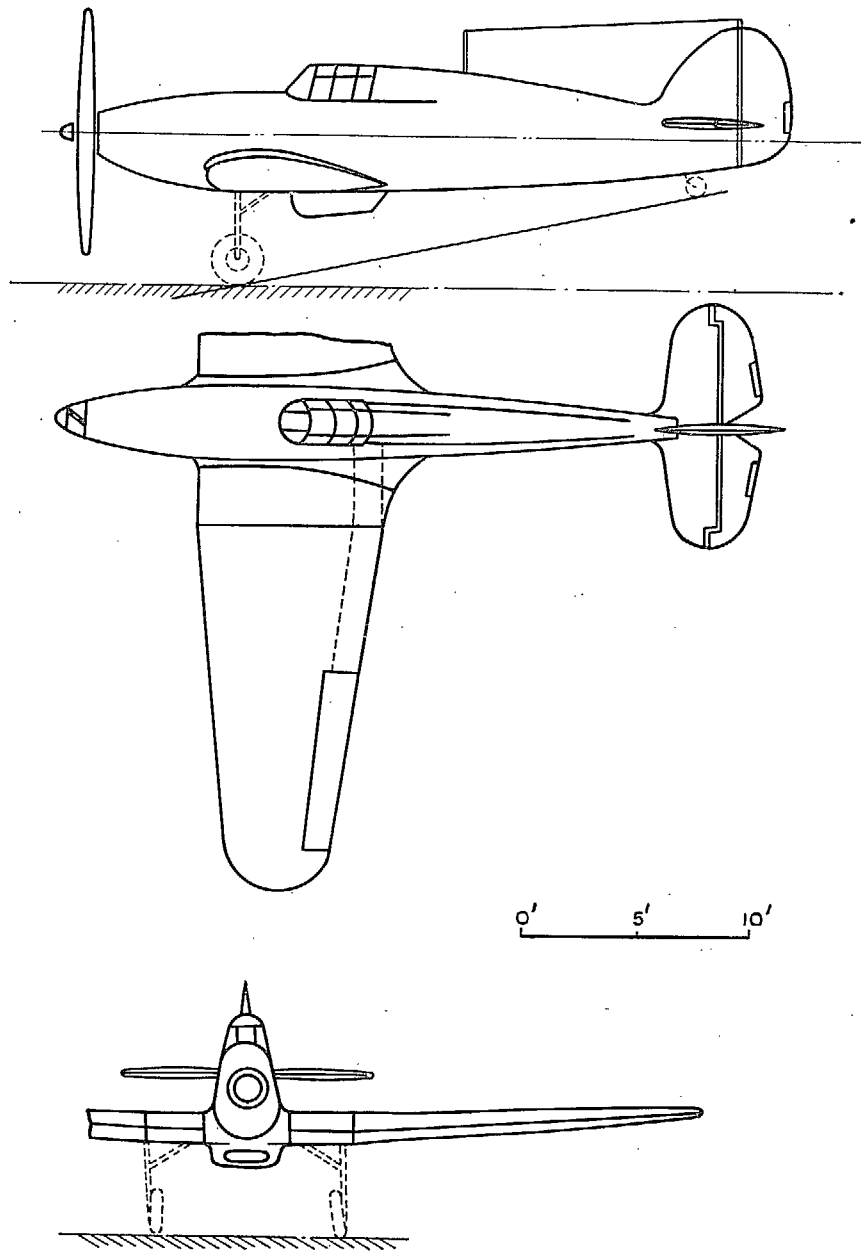
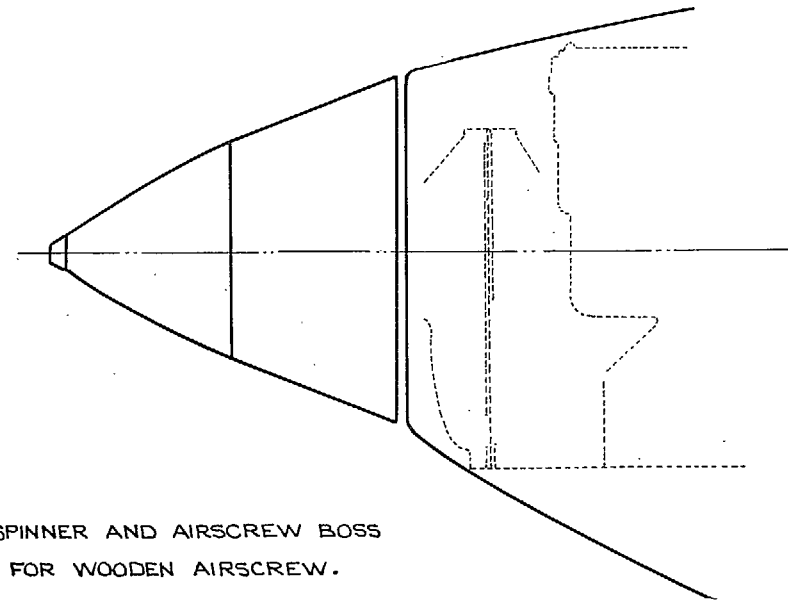
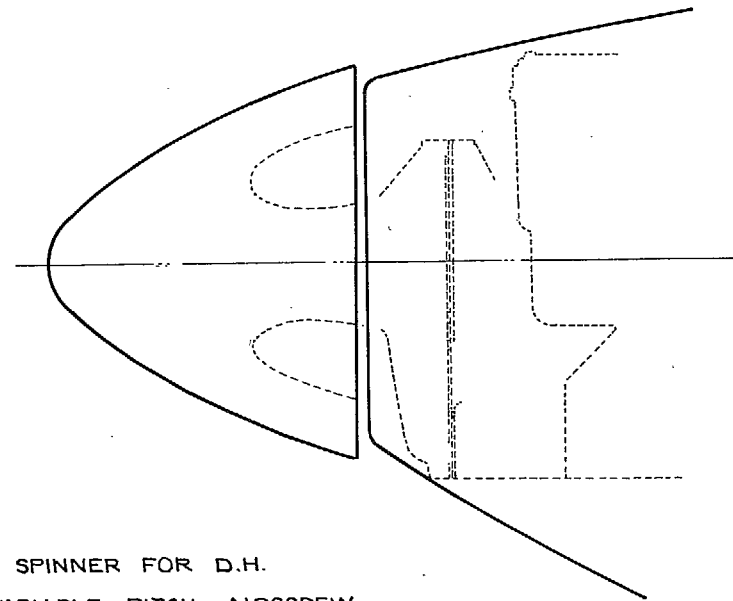

FIG. 2. Hurricane.



SPINNER AND AIRSCREW BOSS FOR WOODEN AIRSCREW.



SPINNER FOR D.H. VARIABLE-PITCH AIRSCREW.

FIG. 3.

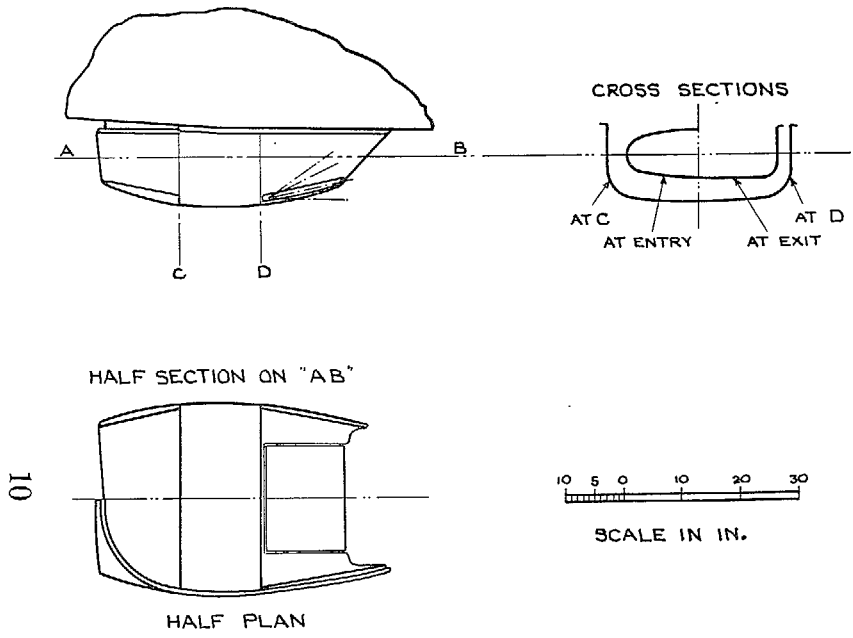

AREAS.

ENTRY	==	1.17 SQ FT
EXIT	==	1.05 SQ FT
RADIATOR MATRIX	==	2.2 SQ FT

FIG. 4. Hurricane Radiator.

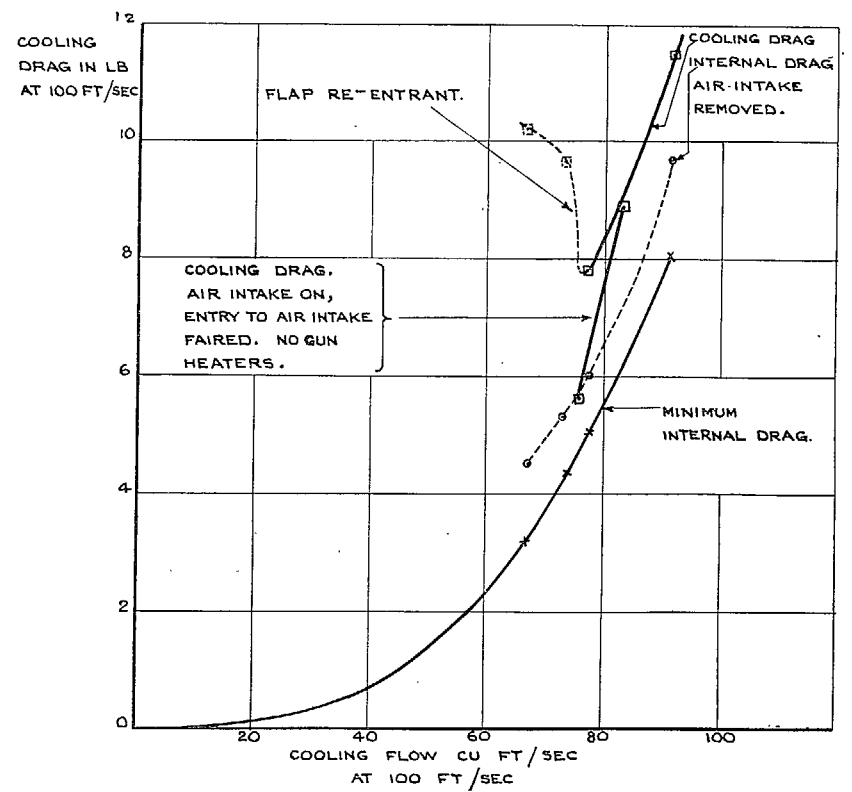

FIG. 5. Hurricane L.1696 in 24-ft tunnel. Curves of Cooling Drag against Cooling Flow.

Publications of the Aeronautical Research Council

ANNUAL TECHNICAL REPORTS OF THE AERONAUTICAL RESEARCH COUNCIL (BOUND VOLUMES)

- 1936 Vol. I. Aerodynamics General, Performance, Airscrews, Flutter and Spinning. 40s. (40s. 9d.)
Vol. II. Stability and Control, Structures, Seaplanes, Engines, etc. 50s. (50s. 10d.)
- 1937 Vol. I. Aerodynamics General, Performance, Airscrews, Flutter and Spinning. 40s. (40s. 10d.)
Vol. II. Stability and Control, Structures, Seaplanes, Engines, etc. 60s. (61s.)
- 1938 Vol. I. Aerodynamics General, Performance, Airscrews. 50s. (51s.)
Vol. II. Stability and Control, Flutter, Structures, Seaplanes, Wind Tunnels, Materials. 30s. (30s. 9d.)
- 1939 Vol. I. Aerodynamics General, Performance, Airscrews, Engines. 50s. (50s. 11d.)
Vol. II. Stability and Control, Flutter and Vibration, Instruments, Structures, Seaplanes, etc. 63s. (64s. 2d.)
- 1940 Aero and Hydrodynamics, Aerofoils, Airscrews, Engines, Flutter, Icing, Stability and Control, Structures, and a miscellaneous section. 50s. (51s.)
- 1941 Aero and Hydrodynamics, Aerofoils, Airscrews, Engines, Flutter, Stability and Control, Structures. 63s. (64s. 2d.)
- 1942 Vol. I. Aero and Hydrodynamics, Aerofoils, Airscrews, Engines. 75s. (76s. 3d.)
Vol. II. Noise, Parachutes, Stability and Control, Structures, Vibration, Wind Tunnels. 47s. 6d. (48s. 5d.)
- 1943 Vol. I. (*In the press.*)
Vol. II. (*In the press.*)

ANNUAL REPORTS OF THE AERONAUTICAL RESEARCH COUNCIL—

1933-34	1s. 6d. (1s. 8d.)	1937	2s. (2s. 2d.)
1934-35	1s. 6d. (1s. 8d.)	1938	1s. 6d. (1s. 8d.)
April 1, 1935 to Dec. 31, 1936.	4s. (4s. 4d.)	1939-48	3s. (3s. 2d.)

INDEX TO ALL REPORTS AND MEMORANDA PUBLISHED IN THE ANNUAL TECHNICAL REPORTS, AND SEPARATELY—

April, 1950 - - - - R. & M. No. 2600. 2s. 6d. (2s. 7½d.)

AUTHOR INDEX TO ALL REPORTS AND MEMORANDA OF THE AERONAUTICAL RESEARCH COUNCIL—

1909-1949. R. & M. No. 2570. 15s. (15s. 3d.)

INDEXES TO THE TECHNICAL REPORTS OF THE AERONAUTICAL RESEARCH COUNCIL—

December 1, 1936 — June 30, 1939.	R. & M. No. 1850.	1s. 3d. (1s. 4½d.)
July 1, 1939 — June 30, 1945.	R. & M. No. 1950.	1s. (1s. 1½d.)
July 1, 1945 — June 30, 1946.	R. & M. No. 2050.	1s. (1s. 1½d.)
July 1, 1946 — December 31, 1946.	R. & M. No. 2150.	1s. 3d. (1s. 4½d.)
January 1, 1947 — June 30, 1947.	R. & M. No. 2250.	1s. 3d. (1s. 4½d.)
July, 1951.	R. & M. No. 2350.	1s. 9d. (1s. 10½d.)

Prices in brackets include postage.

Obtainable from

HER MAJESTY'S STATIONERY OFFICE

York House, Kingsway, London, W.C.2; 423 Oxford Street, London, W.1 (Post Orders:
P.O. Box 569, London, S.E.1); 13a Castle Street, Edinburgh 2; 39, King Street, Manchester, 2;
2 Edmund Street, Birmingham 3; 1 St. Andrew's Crescent, Cardiff; Tower Lane, Bristol 1;
80 Chichester Street, Belfast, or through any bookseller