

**C.P. No. 262**

(17.502)

A.R.C. Technical Report

**C.P. No. 262**

(17.502)

A.R.C. Technical Report



NO. RIL 144  
A.C.  
A.C. 1

MINISTRY OF SUPPLY

AERONAUTICAL RESEARCH COUNCIL

CURRENT PAPERS

# Flow Direction Measurements in Supersonic Wind Tunnels

*By*

D. J. Raney, B.Sc.Eng., A.C.G.I., D.I.C.

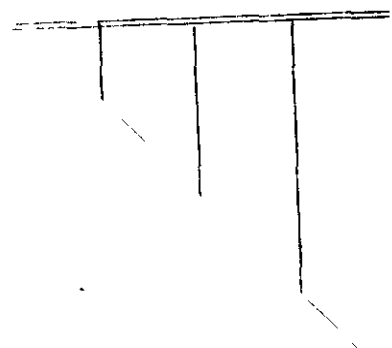
LONDON. HER MAJESTY'S STATIONERY OFFICE

1956

THREE SHILLINGS NET

2 14, 0 4

1 FEB -





C.P. No. 262

U.D.C. No. 533.6.071.4.011.5

Technical Note No. Aero. 2342

September, 1954

ROYAL AIRCRAFT ESTABLISHMENT

Flow direction measurements in supersonic wind tunnels

by

D.J. Raney, B.Sc.Eng., A.C.G.I., D.I.C.

---

SUMMARY

Some general requirements for satisfactory flow direction measurements in supersonic tunnels are stated and examples are given of the design and calibrations of typical yawmeters. The results of flow direction measurements made in two tunnels are given and some of the flow characteristics are discussed.

---



## LIST OF CONTENTS

	<u>Page</u>
1 Introduction	3
2 General Requirements	3
3 Yawmeter designs	4
3.1 Direct reading yawmeters	4
3.2 Indirect reading yawmeters	4
4 Results of tunnel calibrations	5
4.1 R.A.E. No.6 Tunnel ( $M = 2.5$ )	6
4.2 R.A.E. No.18 Tunnel ( $M = 1.61$ )	6
5 Discussion	6
References	7

## LIST OF ILLUSTRATIONS

	<u>Fig.</u>
Change in flow direction with increment of Mach Number	1
Yawmeters used for tunnel calibrations	2
Sensitivity of conical yawmeters	3
Yawmeter calibrations: atmospheric stagnation pressure	4
Flow direction measurements in the R.A.E. No.6 (6 in x 11 in) tunnel at $M = 2.50$	5
Flow direction measurements in the R.A.E. No.18 (9 in x 9 in) tunnel $M = 1.61$ . Angle of pitch in horizontal plane through tunnel $Q_1$	6
Flow direction measurements in the R.A.E. No.18 (9 in x 9 in) tunnel $M = 1.61$ . Angle of yaw in horizontal plane through tunnel $Q_1$	7
Flow direction measurements in the R.A.E. No.18 (9 in x 9 in) tunnel $M = 1.61$ . Angle of pitch in vertical plane through tunnel $Q_1$	8
Flow direction measurements in the R.A.E. No.18 (9 in x 9 in) tunnel $M = 1.61$ . Angle of yaw in vertical plane through tunnel $Q_1$	9
Resultant flow direction at a section through the R.A.E. No.18 (9 in x 9 in) tunnel $M = 1.61$ . 2.9 in. upstream of window $Q_1$	10

to avoid condensation shocks. At high Mach numbers when this ideal may not be possible to achieve, the dryness should be kept constant at as low a value as possible. Stagnation temperature should also be kept constant.

The boundary layer on the tunnel wall can have an important influence on the distribution in the working section. Precautions should therefore be taken to ensure stable conditions by fixing boundary layer transition at a position upstream of the throat<sup>1</sup>.

### 3 Yawmeter designs

The types of instruments suitable for use in supersonic tunnels are

(1) Direct reading instruments from which the flow direction is determined from the inclination of the instrument when it aligns itself, or when it is aligned, with the local flow.

(11) Indirect reading instruments which remain fixed in angle relative to the tunnel and from which the flow direction is determined by the effects of flow changes which they induce.

These two types of instruments are considered separately.

#### 3.1 Direct reading yawmeters

Direct reading yawmeters tend to be more complex than indirect reading instruments. Their chief advantage is that indicated flow direction is independent of Mach number and all flow parameters other than direction, assuming uniform conditions over the yawmeter. Instruments of this type are more suited to tests where these parameters are likely to vary than for a normal tunnel calibration. The two main types of direct reading instruments are the vane type which automatically aligns itself to the local stream direction, and the pressure type of instrument which has to be set to zero incidence. Several types of instruments with freedom in one and also in two planes have been designed for various purposes. They must be accurately balanced and have negligible friction. The extreme accuracy needed to achieve this in suitably small instruments precludes their use for tunnel calibration.

The pressure type yawmeter used as a null reading instrument requires a complicated mechanism to vary the angles of pitch and yaw and is more expensive in tunnel running time for no gain in accuracy compared with its use as an indirect reading instrument, when used in the relatively uniform flow to be explored in a tunnel calibration.

#### 3.2 Indirect reading yawmeters

Flow direction is obtained from an indirect reading yawmeter, which might measure a change in pressure or force, by comparing this change with that measured during a calibration of the instrument. This calibration of the yawmeter must be made at the Mach number and stream stagnation pressure appropriate to the calibration of the tunnel.

The most common form of the indirect reading instrument is the differential pressure yawmeter. There are a number of designs all of which make use of the pressure difference set up by a pair of holes in opposite sides of the instrument when it is at incidence. The flow angle in any plane may be measured by an appropriate setting of the holes; for a tunnel calibration the flow angles in pitch and yaw are normally required and it is possible to measure these concurrently with an instrument having two pairs of holes in planes perpendicular to each other.

For normal use in tunnel calibrations this design of instrument has many advantages over direct reading yawmeters and is almost universally preferred. They are simple to make compared to the direct reading vane type and the use of complex swivelling gear is avoided. They can be made small enough to enable several to be mounted on a comb which enables tunnel running time for a calibration to be reduced. The differential pressure yawmeter can also be adapted fairly simply to measure both Mach number and flow directions in two planes<sup>2</sup>.

Fig.2 shows three designs of yawmeter heads used at R.A.E. Though the sensitivity increases with apex angle as shown in Fig.3 the sensitivity of the 15° angle cone is adequate for most purposes. Hence the choice of design rests more on other considerations, e.g. ease of manufacture or availability of some sort of multibore tubing. Another problem is to avoid the mutual interference of pitch and yaw. This was largely the reason why one group chose a pyramid head as opposed to a conical head. With conical or hemispherical heads the positions of the pressure holes must be accurately located in two perpendicular planes passing through the axis of the head. With a pyramid shaped head the flow is less three dimensional in character and therefore the exact position of the holes is less critical.

The addition of a pitot tube along the centre of the multibore tubes used in the manufacture of the 90° apex angle heads would make them suitable for measurement of both Mach number and flow direction. It is worth noting that even without a central pitot tube, the four-tube conical yawmeter head can be used to measure Mach number by averaging the pressure measured by the four tubes to obtain the average pressure on the head and deducing the Mach number from theoretical results for yawed cones<sup>3</sup>.

Calibration curves for the three yawmeters shown in Fig.2 are given in Fig.4; they are all linear even when the shock is detached as in the case of the 90° pyramid head at  $M = 1.6$ . Fig.3 includes these results and other published and unpublished results. Assuming that a water manometer can be used to measure differential pressure to  $\pm 0.05$  in. water the error in determining the flow direction is  $\pm 0.025^\circ$  with the 15° yawmeter and  $\pm 0.01^\circ$  with the 90° conical yawmeter. These accuracies are adequate, especially the latter. For convenience at the time, a mercury manometer was used for calibrating the 90° pyramid head. Assuming the pressure difference can be measured to 0.02 in. mercury the possible error is  $\pm 0.04^\circ$  in flow direction. This is barely satisfactory; a water manometer should have been used. These values would represent the order of accuracies of comparative measurements for one setting of the head. The error in setting the head is at least  $\pm 0.1^\circ$  and this therefore determines the error in absolute flow angle.

#### 4 Results of tunnel calibrations

The results of some brief calibrations made of two small tunnels are given. The tunnels are the R.A.E. No.6 tunnel and No.18 tunnel. The following table shows the total variations (neglecting the effects of window joints on yaw) measured in pitch ( $\Delta\alpha$ ) and in yaw ( $\Delta\beta$ ).

Tunnel	Mach Number	Working Section Size	Total variation	
			$\Delta\alpha$ degrees	$\Delta\beta$ degrees
R.A.E. No.6	2.50	6 in x 11 in	1.3	0.9*
R.A.E. No.18	1.61	9 in x 9 in	2.5	2.0

\* Excluding indicated flow angles close to the sidewalls.

#### 4.1 R.A.E. No.6 Tunnel (M = 2.5)

This is an open jet tunnel having a double-sided nozzle, the distance between the side walls being 6 in. Measurements of flow direction were made with a conical head yawmeter of  $90^\circ$  apex angle (Fig. 2b and 4b). The results are given in Fig. 5. Neither pitch nor yaw varies more than  $\pm 0.1^\circ$  along the tunnel centre line for 6 in. downstream from the end of the nozzle. Lateral and vertical traverses at the end of the nozzle show how misloading this result can be. There is a strong in-flow towards the tunnel centre line in both planes. An in-flow in the horizontal plane of about  $0.1^\circ$  near the side walls would be expected as the walls are parallel and the rate of boundary layer growth gives an effective inward slope of this amount, but the measured deviation is much greater than  $0.1^\circ$ . The nozzle walls are each corrected for the boundary layer growth in two walls and hence an outflow would be expected in pitch on a vertical traverse. An error in the setting or shaping of the nozzles seems probable.

#### 4.2 R.A.E. No.13 Tunnel (M = 1.61)

This is a closed circuit variable pressure tunnel. A comprehensive investigation of the Mach number distributions through the working section is given in Ref. 1, but systematic measurements of flow direction have not yet been made.

The results of some preliminary measurements with a comb of four-tube  $90^\circ$  pyramid yawmeters (Fig. 2c and 4c) in horizontal and vertical planes through the tunnel centre line at  $M = 1.61$  are given in Figs. 6-9. Some of the traverses were done in two parts; due to an error in measuring the settings of the yawmeter heads a discontinuity in slope appears where one traverse ends and the other begins. For most of the tests one of the windows was fitted in the side wall with a step of 0.007 in. between the frame and the side wall; the resulting disturbance in yaw can be easily traced through the test section (Fig. 7). This step was later reduced to 0.001 in. and the disturbance was substantially reduced (Fig. 7, top curve). The step at the window joint on the other side of the tunnel varied up to 0.002 in. Its effect can be measured though it was appreciably less than that of the other window. Very large changes in flow direction occur at sections across the tunnel. This is illustrated in Fig. 10 for a typical section, 2.9 in. upstream of the centres of the windows, which is not affected by disturbances from the windows. The figure shows the existence of a clockwise rotation of the flow through the working section. This had previously been suspected from the results of rolling moment measurements on a model. In addition to the rotation there is a divergence of the flow from the tunnel centre line.

### 5 Discussion

It has been shown (Fig. 3 and 4) that by using differential water manometers to measure the difference in pressure registered by a yawmeter high sensitivities of the order of 5 - 10 in. of water per degree incidence can be obtained at moderate supersonic Mach numbers with yawmeters having quite a wide range of apex angle. The choice of apex angle can thus be made for reasons other than maximum sensitivity. Some work has been done with the primary objective of developing yawmeters of small dimensions for use in exploring flow fields behind cruciform wings at high incidences. An apex angle of  $90^\circ$  has been found to be very satisfactory for this purpose, giving a linear calibration over a wide range of incidence. There appears to be little to choose in practice between instruments having conical and pyramid heads; the manufacturing problems appear to be of the same order.



The largest uncertainty in flow direction measurements (about  $\pm 0.1^\circ$ ) is in the basic setting of the yawmeter; this does not, of course, affect comparative measurements made with the same setting.

Care should be taken in yawmeter measurements to ensure that the nose shock is either attached or detached for any given set of measurements. Experience has shown that attachment or detachment of the shock gives a change in calibration.

Some interesting features are shown by the yawmeter calibrations of two tunnels presented in section 4.

There are more minor irregularities in pitch than in yaw. Those in pitch arise from small irregularities in the nozzle surface. The side walls are of steel and were machined flat and therefore do not normally cause small random irregularities in flow. In the calibration of the No.18 tunnel bad window joints in the side walls caused serious disturbances in the flow and in this size of tunnel it appears that steps at window joints should be less than about 0.001 in.

The calibration of the No.6 tunnel shows a strong in-flow from the walls towards the centre line in the vertical and transverse planes. No explanation can be offered but it indicates the need for flow direction calibrations off the centre line.

Some degree of rotational flow has been measured in a number of low speed tunnels (see for example Ref.4). These have been attributed to either the fan or to turning vanes at corners. Measurements in the No.18 tunnel show that, in spite of the large contraction ratio, some rotational flow may also exist in a supersonic tunnel. The measurements reported here indicate a rotational flow having a resultant angle of about  $1^\circ$ .

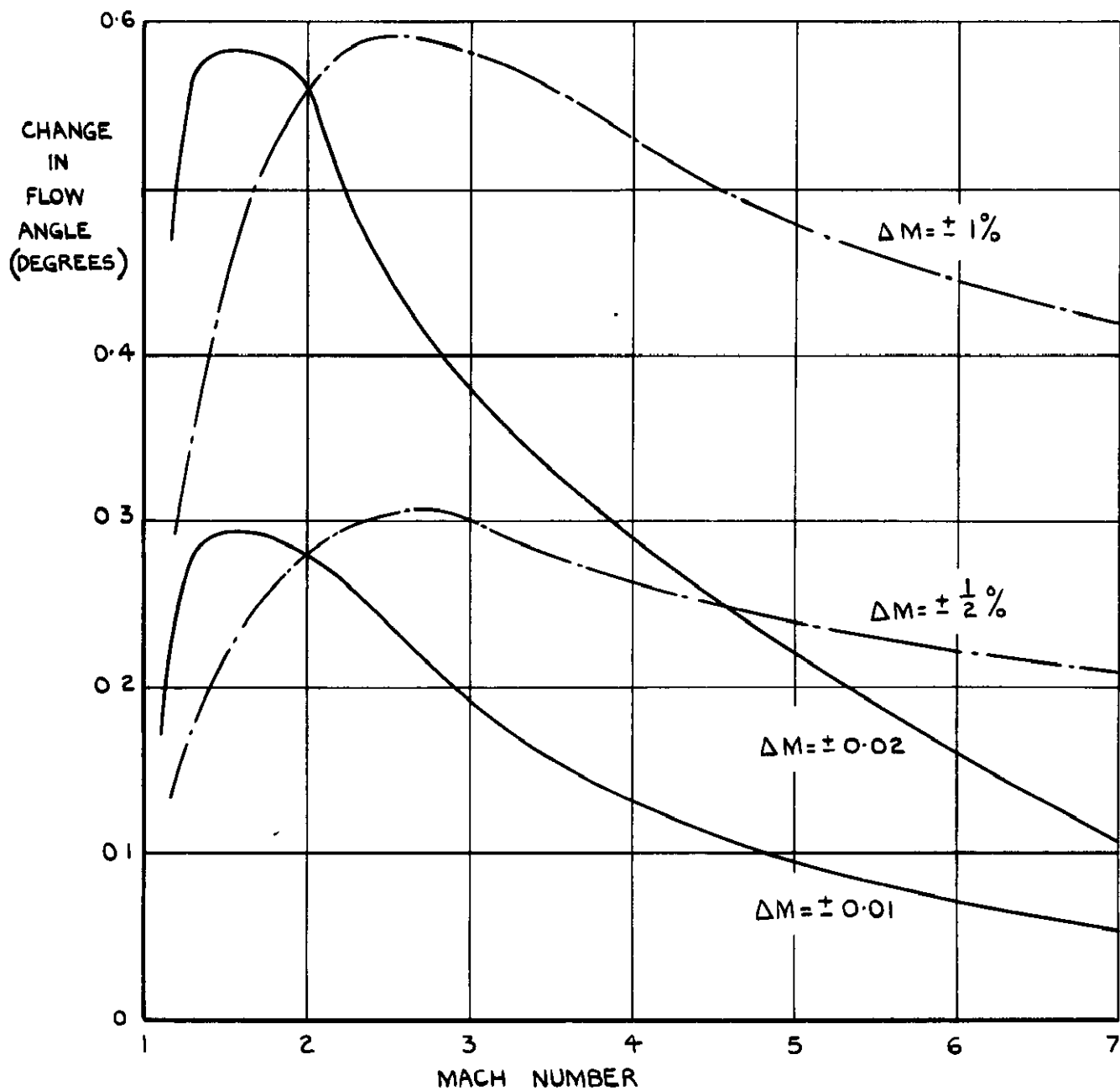
This last feature of the flow in the No.18 tunnel shows how important it is to make yawmeter calibrations of supersonic tunnels. The existence of the rotation of the flow would not have been suspected from pressure measurements (Ref.1).

---

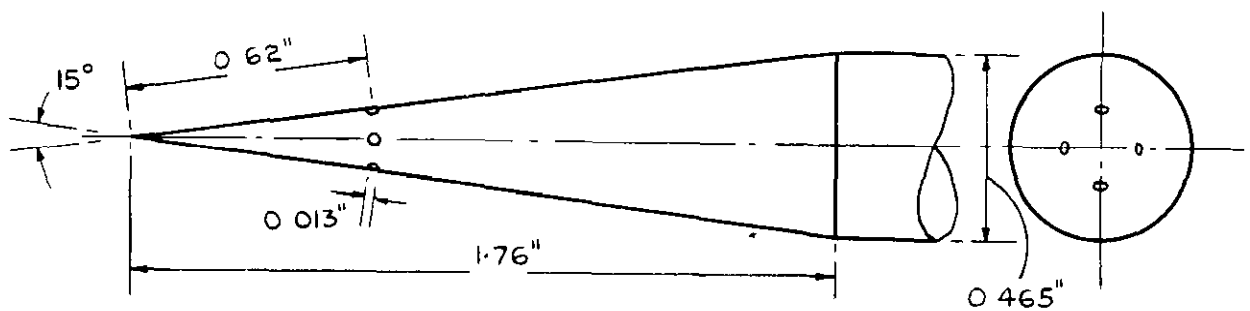
#### REFERENCES

<u>No.</u>	<u>Author</u>	<u>Title, etc.</u>
1	W.T. Lord D. Beastall	Calibration of the R.A.E. No.18 (9 in x 9 in) supersonic wind tunnel. Part I. Preliminary investigations. Current Paper 162. September, 1953
2	L.J. Beecham S.J. Collins	Static and dynamic response of a design of differential pressure yawmeter at supersonic speeds. R.A.E. Report No. G.W.19.
3	A.H. Stone	On supersonic flow past a slightly yawing cone. Journal of Mathematics and Physics. Vol.27 No.1.
4	V.M. Faulkner H.L. Nixon	Experiments on airflow in the 7 ft open jet No.1 tunnel and application to wind tunnel design. R. & M. 2484. January, 1947.

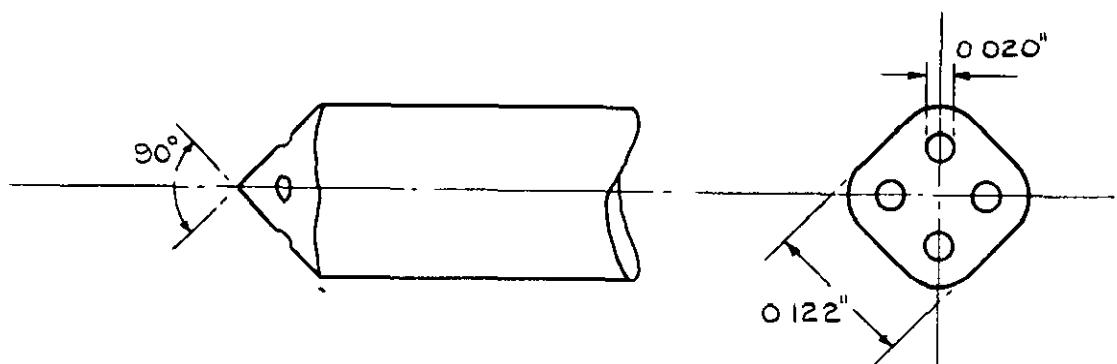




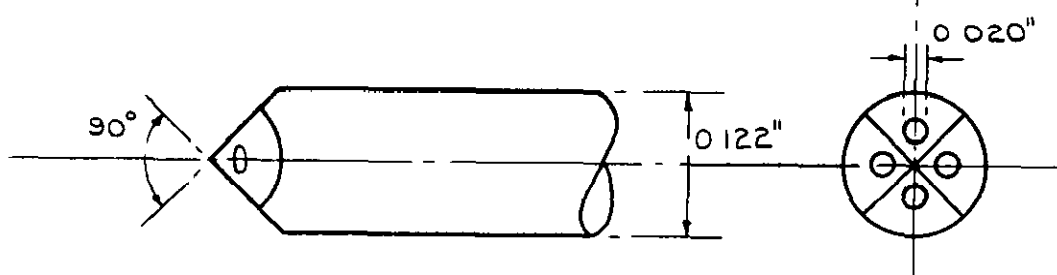
**FIG. I. CHANGE IN FLOW DIRECTION WITH INCREMENT OF MACH NUMBER.**



(a) 15° CONICAL YAWMETER



(b) 90° CONICAL YAWMETER



(c) 90° PYRAMID YAWMETER

FIG. 2 (a-c) YAWMETERS USED FOR TUNNEL CALIBRATIONS.

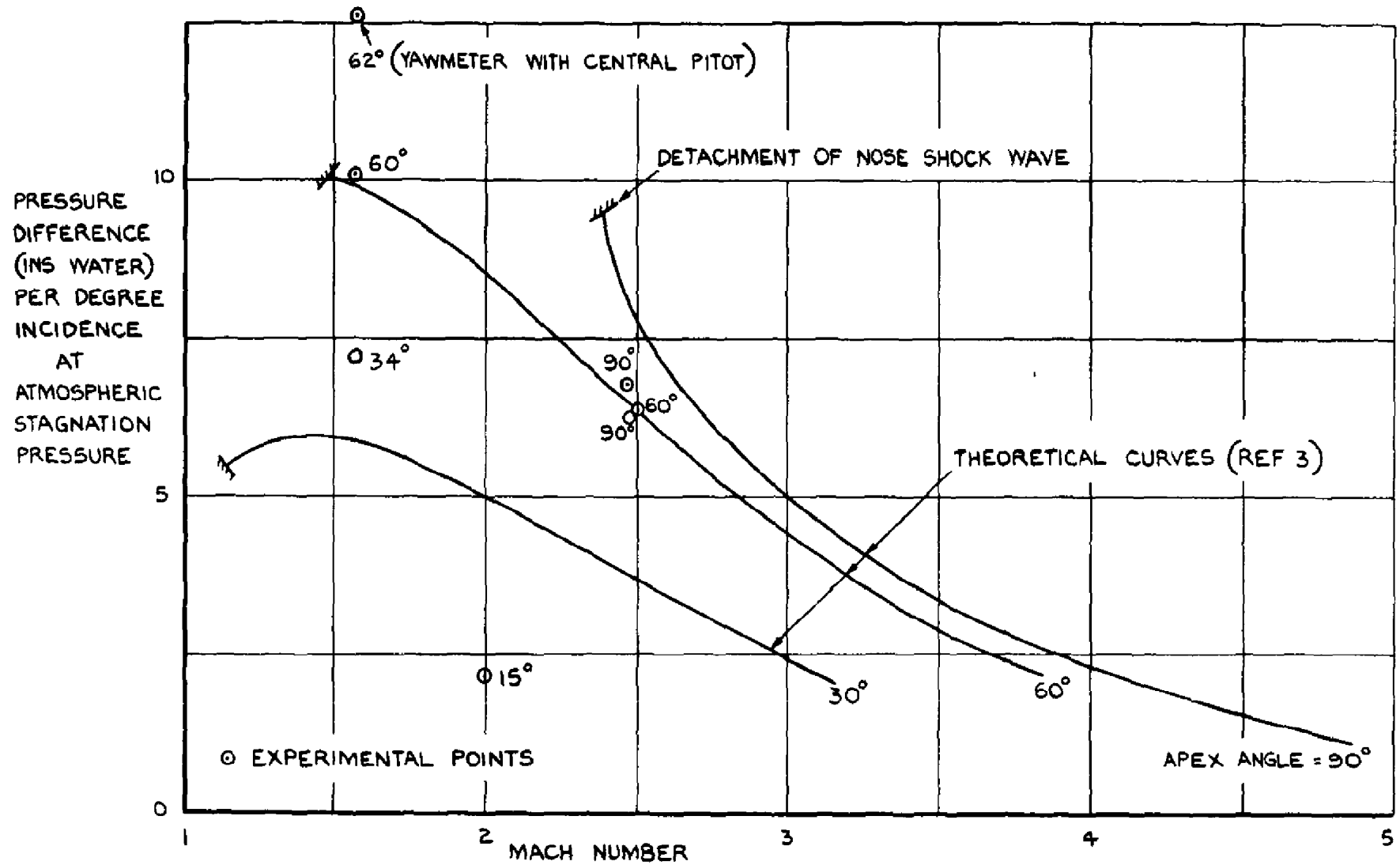
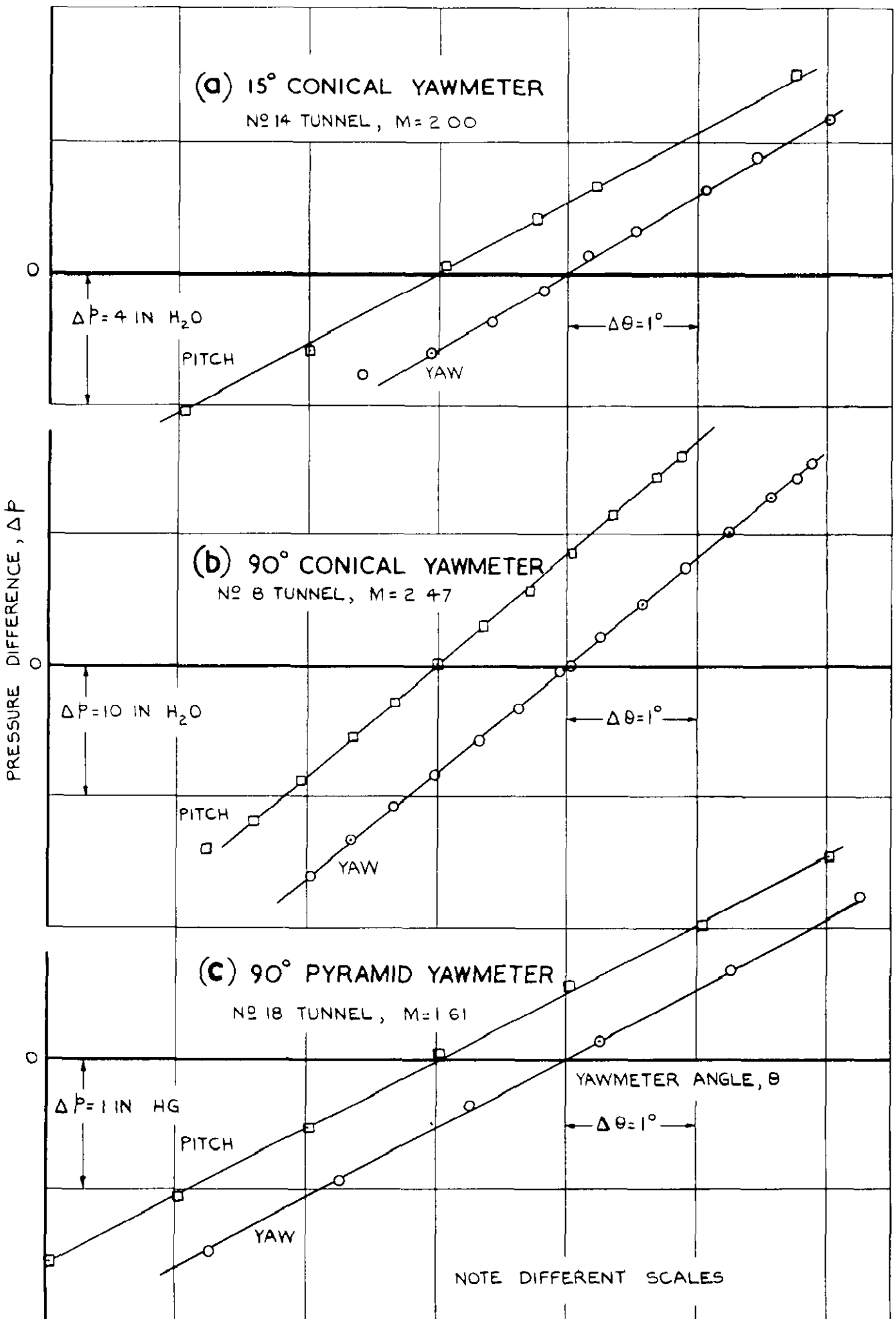
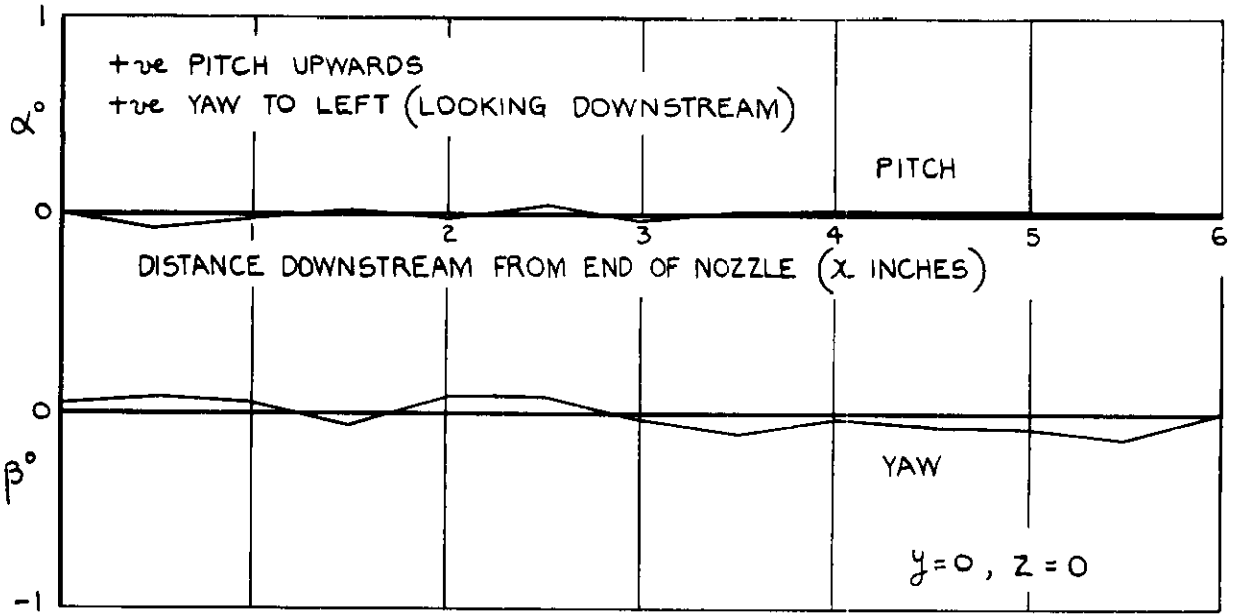


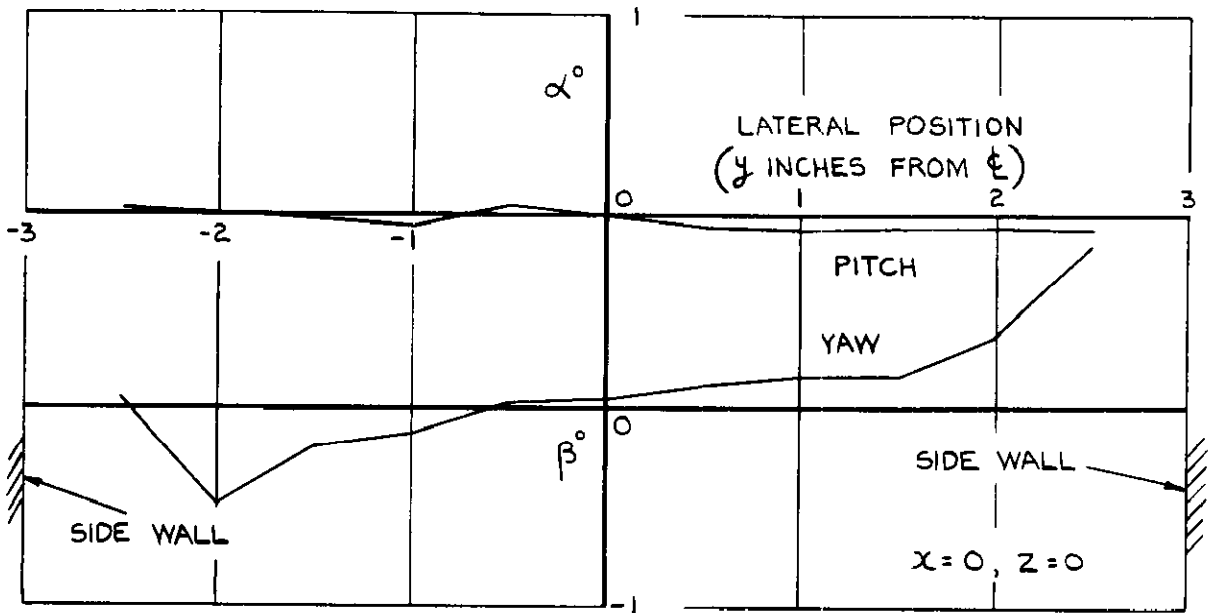
FIG. 3. SENSITIVITY OF CONICAL YAWMETERS.



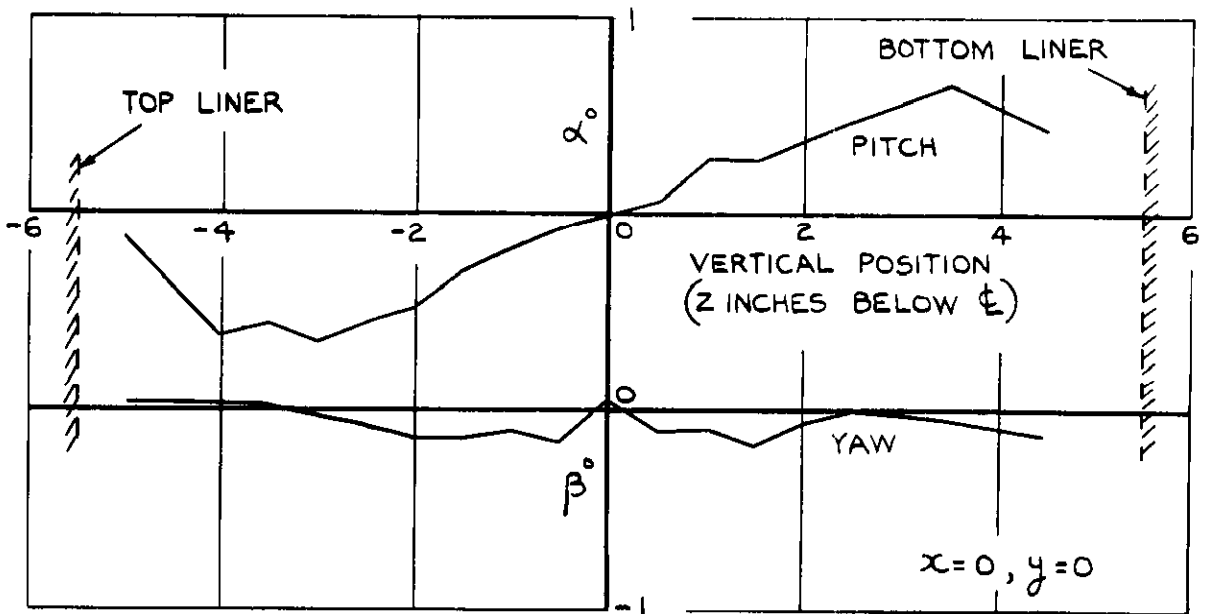
**FIG.4 (a-c) YAWMETER CALIBRATIONS.**  
 ATMOSPHERIC STAGNATION PRESSURE.



(a) AXIAL TRAVERSE ALONG TUNNEL  $\phi$ .



(b) LATERAL TRAVERSE AT END OF NOZZLE



(c) VERTICAL TRAVERSE AT END OF NOZZLE.

FIG.5.(a-c). FLOW DIRECTION MEASUREMENTS IN THE R.A.E. NO.6 (6"x11") TUNNEL AT  $M = 2.50$ .

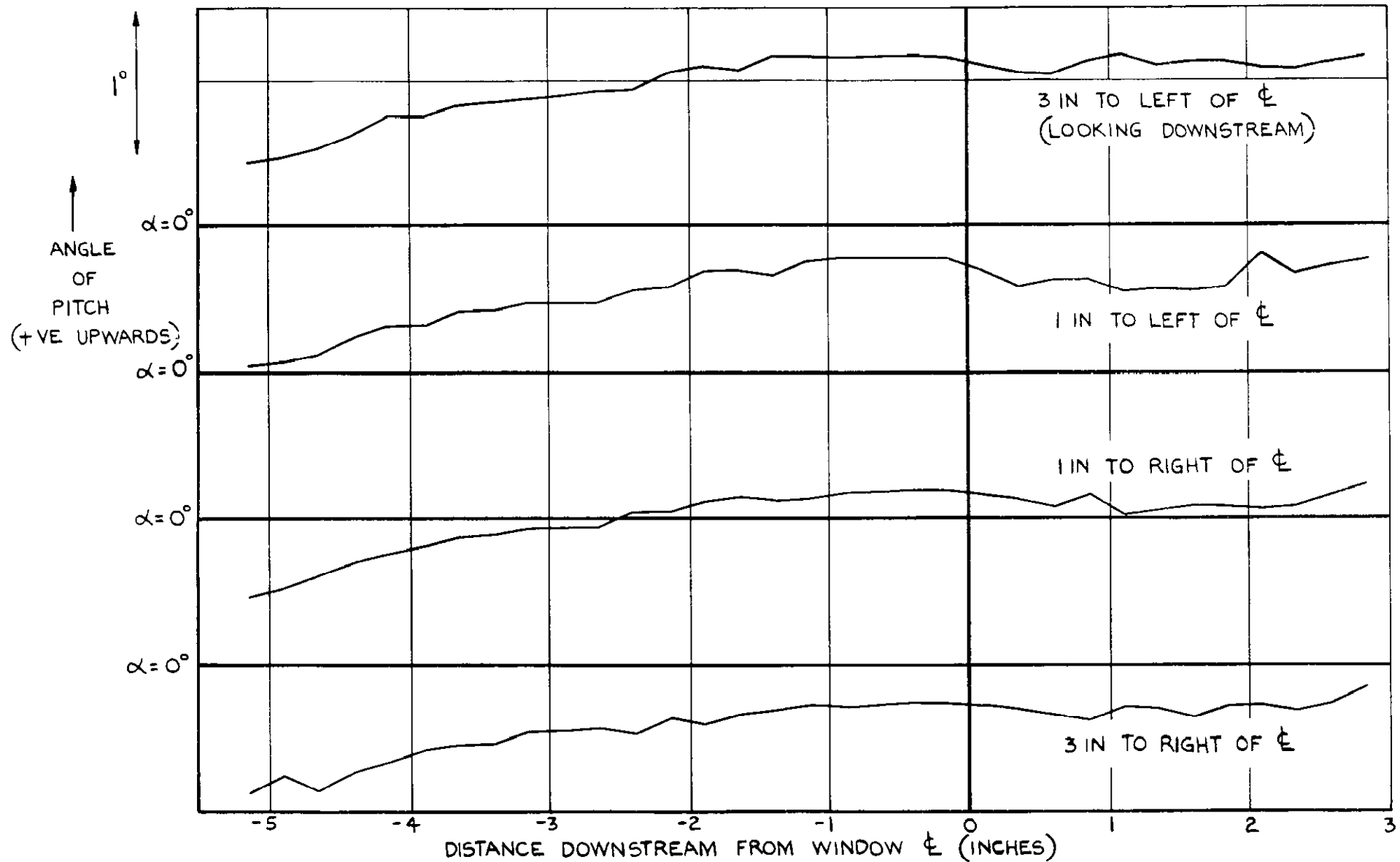


FIG.6. FLOW DIRECTION MEASUREMENTS IN THE R.A.E. NO. 18 (9" x 9") TUNNEL;  $M=1.61$ .  
 ANGLE OF PITCH IN HORIZONTAL PLANE THROUGH TUNNEL  $\phi$



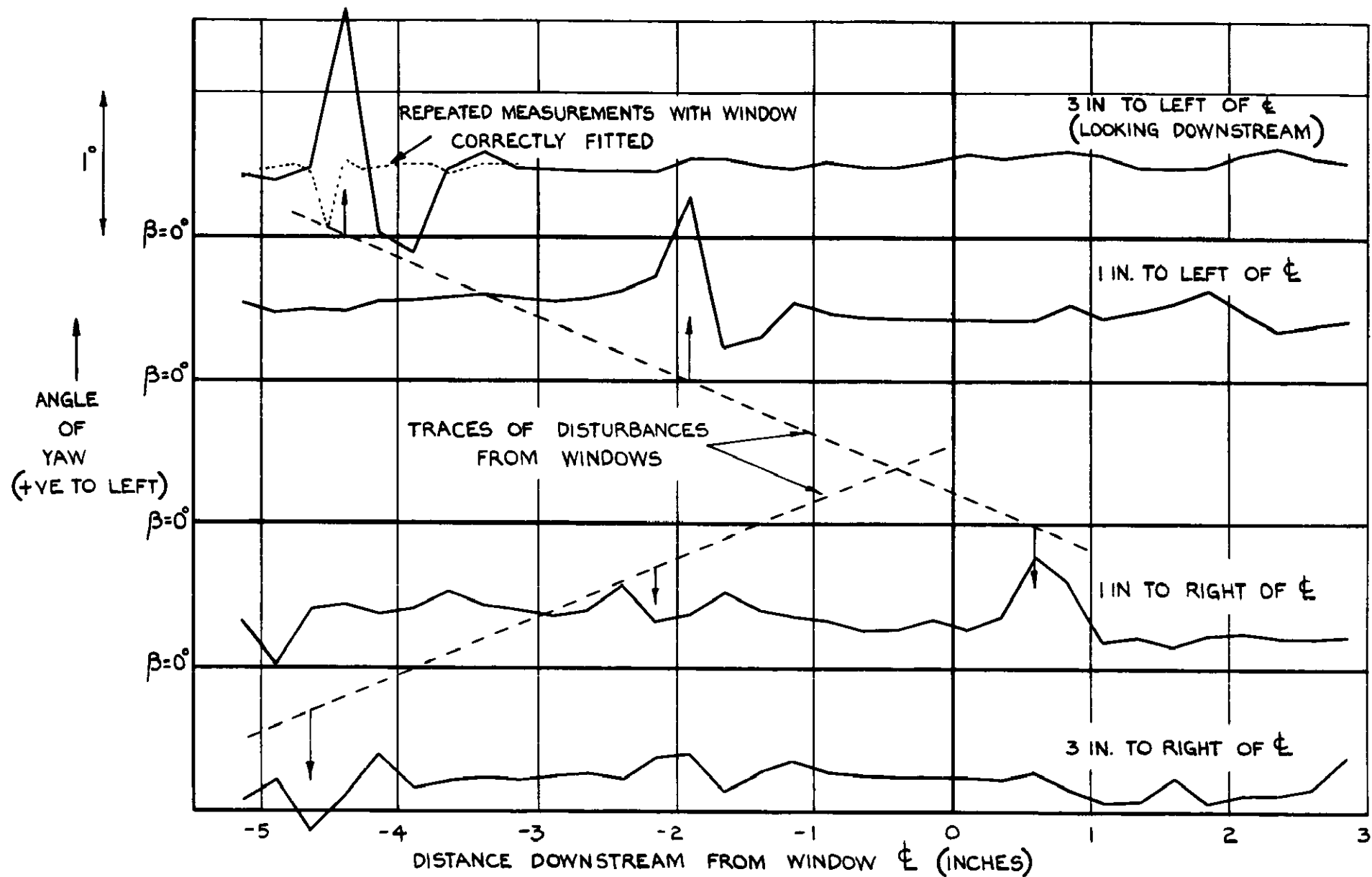


FIG.7. FLOW DIRECTION MEASUREMENTS IN THE R.A.E. NO.18 (9" x 9") TUNNEL;  $M=1.61$ .  
 ANGLE OF YAW IN HORIZONTAL PLANE THROUGH TUNNEL  $\phi$ .

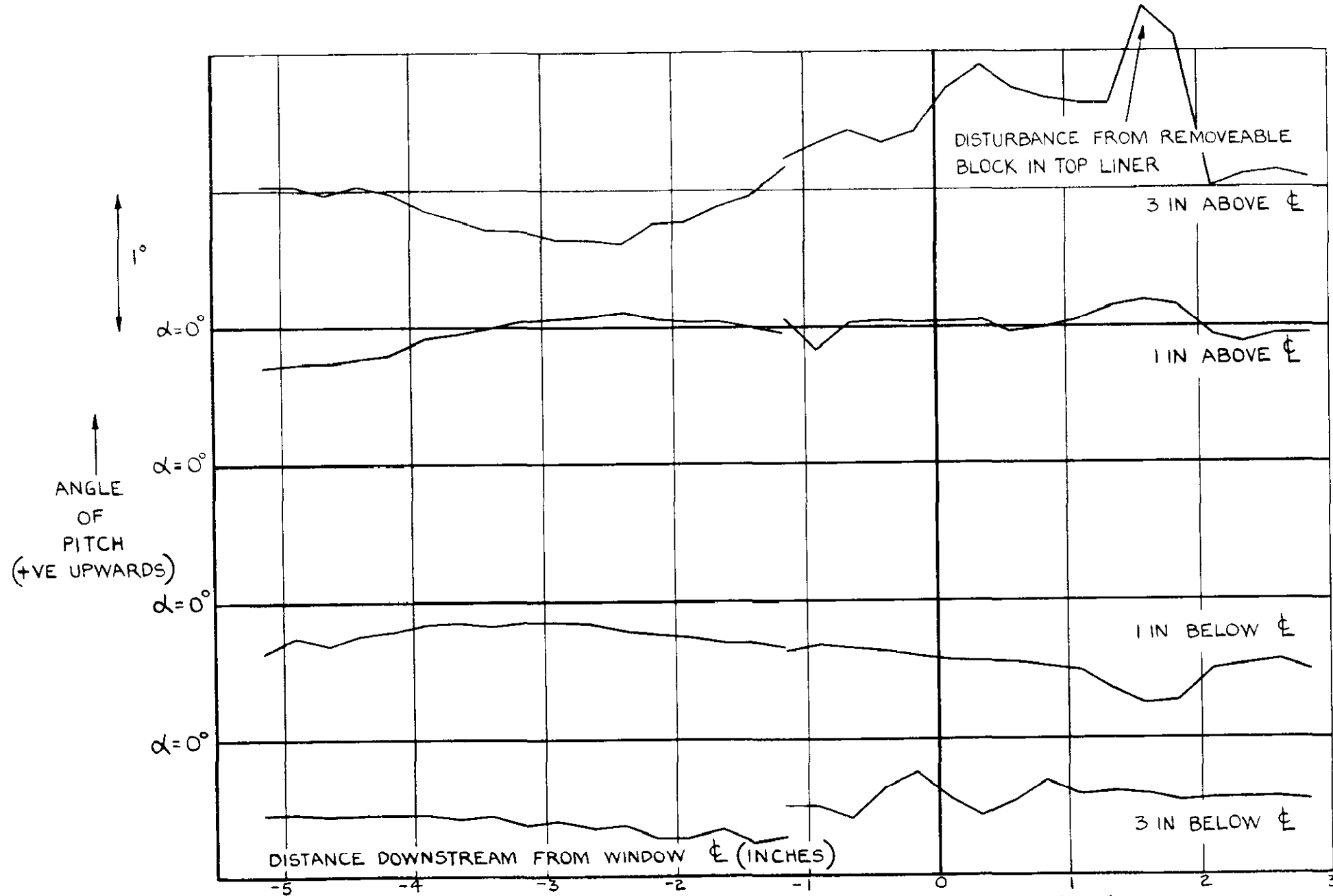
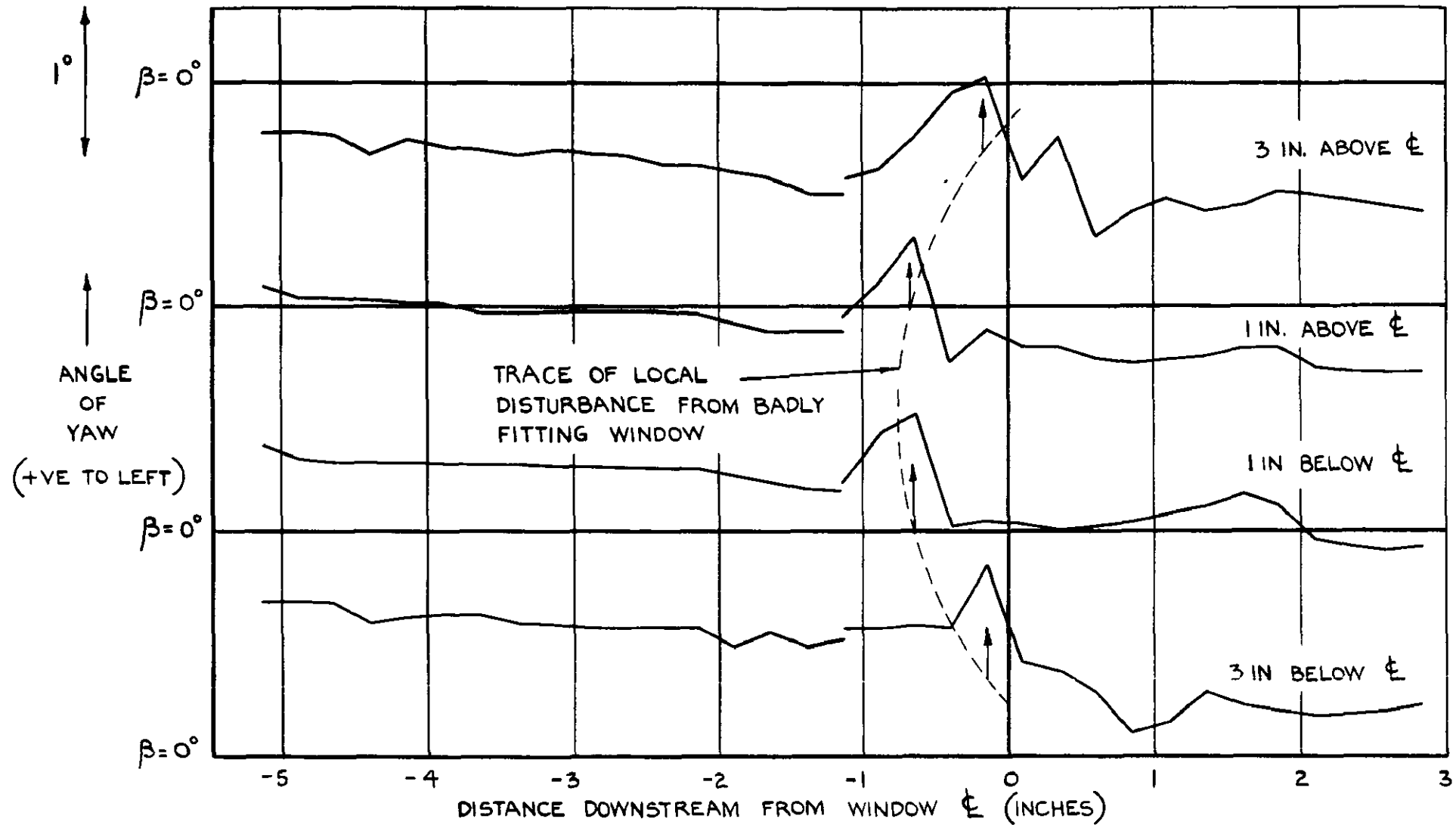
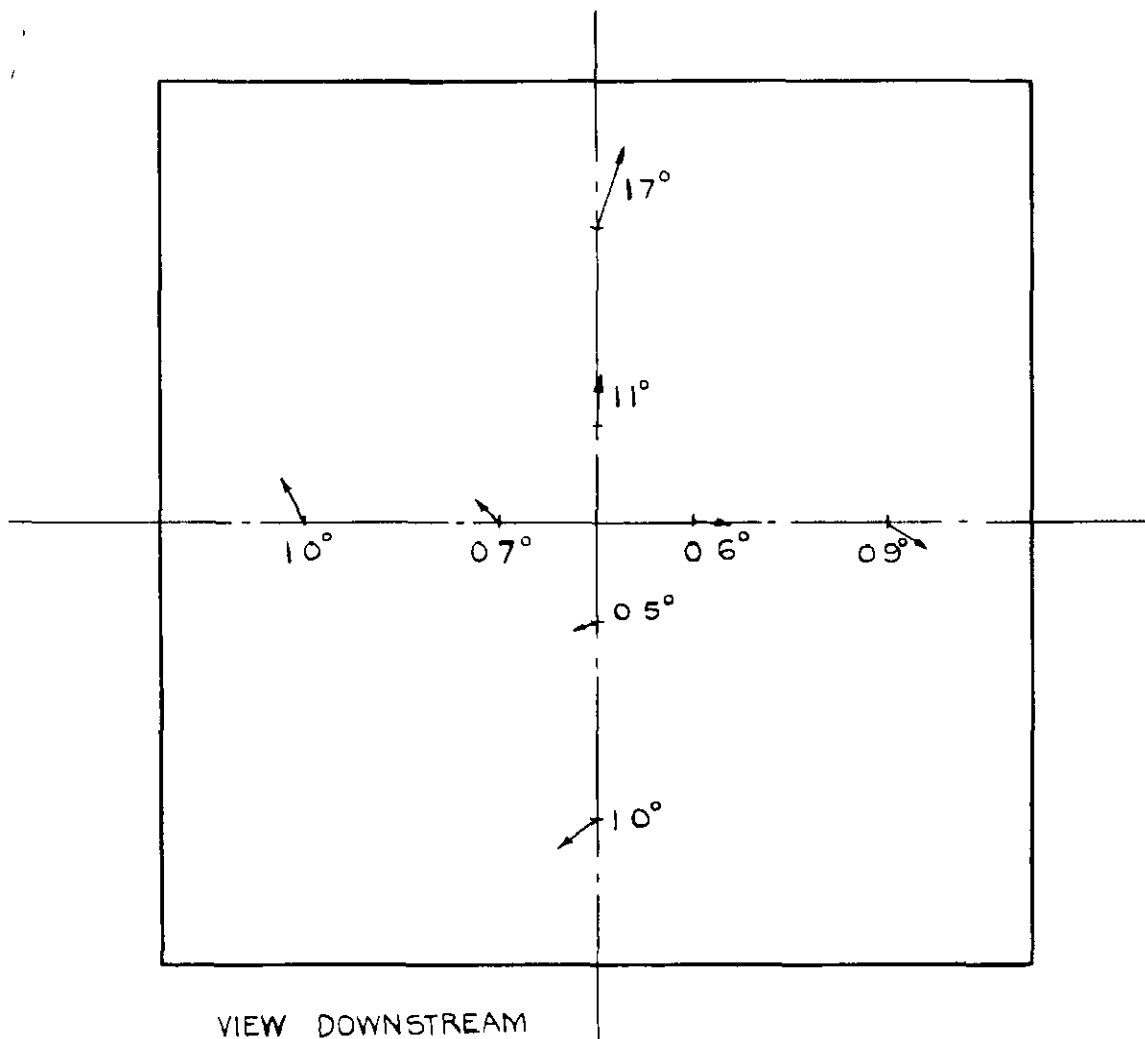


FIG.8. FLOW DIRECTION MEASUREMENTS IN THE R.A.E. NO.18 (9" x 9") TUNNEL; M=1.61.  
 ANGLE OF PITCH IN VERTICAL PLANE THROUGH TUNNEL C



**FIG.9. FLOW DIRECTION MEASUREMENTS IN THE R.A.E. NO.18 (9" x 9") TUNNEL;  $M = 1.61$ .  
 ANGLE OF YAW IN VERTICAL PLANE THROUGH TUNNEL  $\zeta$ .**



VECTORS GIVE ANGULAR DEFLECTION OF AIRSTREAM FROM AXIAL DIRECTION

FIG.10. RESULTANT FLOW DIRECTION AT A SECTION THROUGH THE R.A.E. NO 18 (9"×9") TUNNEL.

2.9" UPSTREAM OF WINDOW  $\phi$ ,  $M = 1.61$ .





*Copyright reserved*

Published by  
HER MAJESTY'S STATIONERY OFFICE

To be purchased from  
York House, Kingsway London WC 2  
423 Oxford Street London W 1  
P.O. Box 309 London SE 1  
133 Castle Street, Edinburgh 2  
109 St. Mary Street, Cardiff  
39 King Street, Manchester 2  
Lower Lane, Bristol 1  
2 Edmund Street, Birmingham 3  
56 Chichester Street Belfast  
or through any bookseller

PRINTED IN GREAT BRITAIN