

NACA TN 4256 76501

0066795



TECH LIBRARY KAFB, NM

# NATIONAL ADVISORY COMMITTEE FOR AERONAUTICS

TECHNICAL NOTE 4256

WATER-IMPACT THEORY FOR AIRCRAFT EQUIPPED  
WITH NONTRIMMING HYDRO-SKIS MOUNTED  
ON SHOCK STRUTS

By Emanuel Schnitzer

Langley Aeronautical Laboratory  
Langley Field, Va.



Washington

September 1958

TECHNICAL LIBRARY  
SEP 2011



0066795

## NATIONAL ADVISORY COMMITTEE FOR AERONAUTICS

## TECHNICAL NOTE 4256

## WATER-IMPACT THEORY FOR AIRCRAFT EQUIPPED

## WITH NONTRIMMING HYDRO-SKIS MOUNTED

ON SHOCK STRUTS<sup>1</sup>

By Emanuel Schnitzer

## SUMMARY

Theoretical equations are derived for the motion of aircraft equipped with hydro-skis mounted on shock struts during take-off and landing operations on a water surface. The case considered involves a ski which is fixed in trim relative to the aircraft and which translates upward during impact and thus telescopes the shock strut. Two hydrodynamic force relations, one more accurate but more complex than the other, are considered. Incorporation of suitable shock-strut spring and damping approximations along with the simpler hydrodynamic-force term allows the equations to be written in nondimensional form for design-trend studies. Such trend-study solutions have been made for a broad range of practical water impacts and are presented as dimensionless plots. The equations involving the more accurate force term are usable only in the dimensional form as presented, but they allow any spring type, any exponential damping constant, and a variety of ski bottom shapes to be included in the solutions. Thus the trend-study solutions may be used for rough preliminary design and the more accurate solutions for final design. An appendix is included which gives a simple step-by-step procedure for solving any of the sets of equations derived in the paper.

## INTRODUCTION

This paper deals with theoretical methods for treating oblique water impacts of aircraft equipped with nontrimming hydro-skis mounted on shock struts. The shock-mounted hydro-ski has become of interest in recent years primarily as a landing device for high-performance aircraft capable of operation from water, snow, ice, or sod bases. In addition to softening the impacts encountered in operations from the solid-material runways, the shock strut allows a wider ski to be used on the water runways without increasing the loads over those encountered with the narrower rigidly

<sup>1</sup>Supersedes NACA Research Memorandum L54H10 by Emanuel Schnitzer, 1954.

mounted ski. Since the wider ski permits easier take-off because of its increased lift-drag ratio, the shock strut indirectly improves take-off performance without increasing the landing load.

Although several ways have been conceived to mount hydro-skis on shock struts, such as, for example, the translating ski mounting, the trimming ski mounting, and the varying-dead-rise ski mounting described in reference 1, this paper is concerned only with the simple translating ski mounting. This design (see fig. 1) incorporates a ski which is fixed in trim relative to the aircraft and which translates upward under load, telescoping the shock strut. It is the purpose of this paper to derive and solve theoretical equations for this case.

The theoretical equations derived in this paper employ the hydrodynamic-force terms of references 2 and 3 in combination with the shock-strut spring and damping terms. The equations employing the force term of reference 2 are simple enough so that with suitable spring and damping restrictions they can be solved and plotted in nondimensional form for use in design-trend studies. Such a study has been made for a broad, practical range of aircraft landing conditions and is included herein. The more accurate equations employing the force term of reference 3 were too complex for expression in dimensionless form and so are presented in the form suitable for dynamic calculations involving a wide range of bottom shapes, spring types, and damping exponents. These more accurate equations might be employed for final design calculations.

The paper is organized as follows: the equations of motion are derived for shock-strut damping proportional to an arbitrary power of the velocity, first for arbitrary spring force, then for constant spring force, and finally for linear spring force. The hydrodynamic-force term is next developed using reference 3 or planing data, and then using reference 2. Following this, the motion equations employing the force term of reference 2 are nondimensionalized for the arbitrary-, constant-, and linear-spring-force approximations and for damping proportional to the square of the strut compression velocity. A discussion of the trend-study solutions of the dimensionless linear spring-force equations is included. An appendix gives a simple step-by-step procedure for solving any of the sets of equations derived in this paper.

#### SYMBOLS

b            beam of ski

$C_{\Delta}$        beam-loading coefficient of ski,  $M/\rho b^3$

- $C_L$  planing lift coefficient based on ski beam,  $F_{V,P} \frac{\rho}{2} \dot{x}^2 b^2$
- $C_V$  speed coefficient,  $\dot{x} / \sqrt{gb}$
- $c$  damping constant of shock strut
- $F$  hydrodynamic force on ski
- $F_s$  spring force
- $f(\tau)$  trim function,  $\frac{0.006\tau^{1.1}}{\sin^{5/2}\tau \cos^2\tau}$ , where  $\tau$  is in degrees
- $g$  acceleration due to gravity
- $H$  constant shock-strut spring force
- $K$  spring constant
- $M$  effective mass of aircraft attached to each shock strut
- $n$  damping exponent
- $T$  nondimensional time variable,  $t \frac{\dot{z}_0}{\eta}$
- $t$  time after contact
- $u$  generalized displacement of ski normal to water surface relative to its position at water contact,  $z/\eta$
- $\dot{u}$  generalized velocity of ski normal to water surface,  $\frac{du}{dT} = \frac{\dot{z}}{\dot{z}_0}$
- $\ddot{u}$  generalized acceleration of ski normal to water surface,  

$$\frac{d^2u}{dT^2} = \ddot{z} \frac{\eta}{\dot{z}_0^2}$$
- $V$  resultant velocity of aircraft
- $\dot{x}$  forward velocity of ski parallel to undisturbed water surface

- $z$  vertical displacement of ski normal to undisturbed water surface relative to its position at water contact
- $\dot{z}$  vertical velocity of ski normal to undisturbed water surface
- $\ddot{z}$  vertical acceleration of ski normal to undisturbed water surface
- $\gamma$  flight-path angle relative to undisturbed water surface
- $\delta$  constant spring-force parameter,  $H \frac{\eta \cos \tau}{M \dot{z}_0^2}$
- $\xi$  displacement of ski keel normal to itself relative to its position at water contact
- $\xi_s$  displacement of ski-step normal to its keel relative to undisturbed water surface
- $\dot{\xi}$  velocity of ski normal to its keel,  $\frac{\dot{z} + \kappa \dot{z}_0}{\cos \tau}$
- $\ddot{\xi}$  acceleration of ski normal to its keel
- $\eta$  nondimensionalizing length,  $\left[ \frac{C_{\Delta} b^{3/2}}{f(\tau)} \right]^{2/3}$
- $\theta$  linear spring-force parameter,  $K \frac{\eta^2}{\dot{z}_0^2 M}$
- $\kappa$  approach parameter,  $\frac{\sin \tau}{\sin \gamma_0} \cos(\tau + \gamma_0)$
- $\lambda$  ratio of mean wetted length to beam for a flat rectangular plate based on undisturbed water surface,  $\frac{z}{b \sin \tau}$
- $\lambda_w$  ratio of mean wetted length to beam based on elevated water surface
- $\mu$  arbitrary spring-force parameter,  $\eta / \cos \tau$
- $\dot{\xi}$  forward velocity of ski parallel to its keel
- $\ddot{\xi}$  forward acceleration of ski parallel to its keel

- $\rho$  mass density of water  
 $\sigma$  ski cross-sectional shape factor  
 $\tau$  trim of ski relative to undisturbed water surface  
 $\phi$  arbitrary spring-force coefficient,  $\frac{\eta \cos \tau}{\dot{z}_0^2 M}$   
 $\psi$  strut damping parameter,  $c \frac{\eta \dot{z}_0^{n-2}}{M \cos^{n-1} \tau}$

## Subscripts:

- e at exit  
m maximum value  
N normal to ski keel  
o at water contact  
p planing  
v normal to water surface

## Superscript:

- ' referring to fuselage of aircraft instead of to ski

## THEORY FOR IMPACT OF SHOCK-MOUNTED HYDRO-SKI

## Equations of Motion

In the following derivation of the equations of motion for the hydrodynamic impact of shock-mounted hydro-skis, a system is considered in which the ski keel is oriented parallel to the plane of symmetry and normal to the axis of the shock strut (see fig. 1). The ski is assumed to remain fixed in trim and since its weight is usually less than 5 percent of the weight of the airplane, the ski mass is neglected. Since the beam-loading coefficient of hydro-skis is usually large, the force due to acceleration of the virtual mass of water is also neglected (ref. 3). In order to further simplify the problem, an additional idealization is made that the aircraft is rigid.

The selection of a shock absorber with desirable force characteristics is a difficult problem in view of the many variables involved in hydro-ski landing operations. The selection of the proper characteristics is therefore left open insofar as possible by writing the equations of motion first for a shock strut having a general type of springing as some arbitrary function of the strut telescoping displacement; two approximate forms for the spring-force function will be considered later. In the derivation the assumptions are made that the shock-strut damping force varies as some arbitrary power of the velocity of compression, that the wing lift of the aircraft is balanced by its weight, and that frictionless flow exists in the water impinging on the ski.

On the basis of the foregoing assumptions, the equation governing motion of a shock-mounted hydro-ski normal to its bottom and neglecting strut telescoping friction (see fig. 1) is

$$F_N = c_1(\dot{\zeta}' - \dot{\zeta})^n + f_1(\zeta_s' - \zeta_s) \quad (1a)$$

when the shock strut is compressing and

$$F_N = -c_2(\dot{\zeta} - \dot{\zeta}')^n + f_1(\zeta_s' - \zeta_s) \quad (1b)$$

when the shock strut is extending. In these equations  $F_N$  is the hydrodynamic force on the ski,  $f_1(\zeta_s' - \zeta_s)$  is the spring or air compression force in terms of the strut telescoping displacement  $\zeta_s' - \zeta_s$ ,  $c_1$  and  $c_2$  are the damping constants,  $n$  is the damping exponent, and  $\dot{\zeta}$  and  $\dot{\zeta}'$  are the normal velocities of the ski and aircraft, respectively. Although, for convenience, the full damping force is sometimes assumed to reverse on shock-strut extension so that  $c_1 = c_2$ , actually in practice a fluid-return dump valve might be employed so that the strut damping force would approach zero on shock-strut extension, and if the ski were in the water during this time the normal load extending the ski would approximate the spring force. Since the lower mass (ski and lower part of shock strut) is neglected, the hydrodynamic normal force of equations (1) is communicated directly to the aircraft fuselage, and since the wing lift is assumed equal to the weight of the aircraft the equation of motion of the fuselage is expressed by Newton's third law as

$$F_N + M\ddot{\zeta}' = 0 \quad (2)$$

where  $M$  is the mass of the aircraft and  $\ddot{\zeta}'$  is the acceleration of the fuselage normal to the keel. If equation (2) is substituted into equations (1), the following equations result:

$$M\ddot{\zeta}' \pm c(\pm\dot{\zeta}' \mp \dot{\zeta})^n + f_1(\zeta_S' - \zeta_S) = 0 \quad (3)$$

where the upper signs signify strut compression and the lower signs strut extension. Equations (2) and (3) may be rewritten in terms of the coordinate system normal to the water surface by means of the following substitutions (see velocity diagram in fig. 1):

$$\ddot{\zeta} = \frac{\ddot{z}}{\cos \tau} \quad (4a)$$

$$\dot{\zeta} = \frac{\dot{z} + \kappa \dot{z}_0}{\cos \tau} \quad (4b)$$

$$\zeta_S = \frac{z}{\cos \tau} \quad (4c)$$

where

$$\kappa = \frac{\dot{\xi} \sin \tau}{\dot{z}_0} = \frac{\sin \tau}{\sin \gamma_0} \cos(\tau + \gamma_0) \quad (4d)$$

and  $\dot{\xi}$  is taken equal to 0 because of the assumption of frictionless flow and no external force, thus rendering  $\xi$  a constant. The relationships between the primed quantities are expressed by similar equations. The substitution of equations (4a), (4b), and (4c) and the primed equivalents into equations (2) and (3) leads to the following expressions:

$$\ddot{z}' + \frac{F_V}{M} = 0 \quad (5)$$

and

$$\ddot{z}' \pm \frac{c}{M \cos^{n-1} \tau} (\pm \dot{z}' \mp \dot{z})^n + f_1 \left( \frac{z' - z}{\cos \tau} \right) \frac{\cos \tau}{M} = 0 \quad (6)$$

since  $\dot{z}'_0 = \dot{z}_0$ . In these equations  $F_V$  is the vertical component of the hydrodynamic force,  $\dot{z}$  and  $\dot{z}'$  are the vertical velocities of the ski and fuselage, respectively, and  $\ddot{z}'$  is the vertical acceleration



of the fuselage. Specific solutions of equations (5) and (6) can be effected, provided that suitable expressions for  $F_v$  and  $f_1$  are available and the constants  $M$ ,  $c$ ,  $n$ ,  $\tau$ , and  $\gamma_0$  are given.

### Spring Force

In some instances it is believed that a shock strut having a constant-force spring exerting a force of slightly greater than 1 g may be desirable. Such a strut would be extended between impacts and during planing. It would therefore make available its entire stroke for impact load reduction. For this case and for those cases where the spring force may be approximated by a constant with reasonable results, the spring term in equation (6) may be written

$$f_1 \left( \frac{z' - z}{\cos \tau} \right) = H \quad (7)$$

where  $H$  is defined as a constant spring force. It should, however, be remembered that when  $\ddot{z}' < \frac{H}{M} \cos \tau$  and  $\zeta_s' - \zeta_s = 0$ , equation (6) modified by equation (7) for constant spring force no longer applies, since the shock strut behaves as a rigid link  $z_s = z_s'$ ,  $\dot{z} = \dot{z}'$ , and  $\ddot{z} = \ddot{z}'$ . In this region, equation (5) and its integrated form will yield solutions for the acceleration of the aircraft.

The air springing force on some existing landing-gear shock struts may be roughly approximated by a straight-line force-deflection curve for some applications. For this approximation the force curve is assumed to intersect the origin of zero force and zero strut compression, although in the actual air-spring case a substantial force exists for negligible strut compressions which enables more rapid reextension of the strut for subsequent impacts. This linear springing reaction is defined as

$$f_1 \left( \frac{z' - z}{\cos \tau} \right) = K \left( \frac{z' - z}{\cos \tau} \right) \quad (8)$$

where  $K$  is the spring constant and  $z'$  and  $z$  are the respective displacements of the fuselage and hydro-ski normal to the undisturbed water surface.

## Hydrodynamic Force

The hydrodynamic impact force for use in solving the equations of motion can be obtained from theoretical or experimental high-speed planing data for the case of the usual heavily loaded hydro-ski under consideration in this paper. An empirical formula for the instantaneous planing lift may be derived from reference 2 or planing experiments, and a theoretical one from reference 3. The application of these formulas to the impact case is given in the subsequent sections following the expression of the impact force in terms of the planing reaction. Although the equations of motion involving the hydrodynamic force from reference 3 or planing experiments are believed to be more accurate than those using the hydrodynamic force from reference 2, the latter equations are simpler and so can be applied in nondimensional form to trend-study solutions.

In order to express the hydrodynamic impact force on a heavily loaded prismatic hydro-ski in terms of the planing reaction, this force, which is directed normal to the keel, is first written in the form

$$F_N = \rho b^2 \dot{\xi}^2 f_2 \left( \frac{z}{b}, \tau, \sigma \right) \quad (9)$$

where  $\rho$  is the mass density of the fluid,  $\sigma$  is the cross-sectional shape factor, and the effect of flight-path angle on the pressure distribution is considered secondary. The hydrodynamic-force term proportional to the normal acceleration of the ski is neglected since it is usually small for large beam loadings. The vertical component of the normal force can be expressed as

$$F_V = \rho b^2 \dot{\xi}^2 f_3 \left( \frac{z}{b}, \tau, \sigma \right) \quad (10)$$

or

$$F_V = \rho b^2 \frac{(\dot{z} + \kappa \dot{z}_0)^2}{\cos^2 \tau} f_3 \left( \frac{z}{b}, \tau, \sigma \right) \quad (11)$$

through the introduction of equation (4b) into equation (10).

The function  $f_3$  can be evaluated for the case of steady planing ( $\gamma = 0$ ) for which  $\dot{\xi} = \dot{x} \sin \tau$  (see fig. 1), where  $\dot{x}$  is the forward velocity parallel to the undisturbed water surface. Substitution of this expression for  $\dot{\xi}$  in equation (10) results in the equation

$$f_3\left(\frac{z}{b}, \tau, \sigma\right) = \frac{F_{V,P}}{\rho b^2 \dot{x}^2 \sin^2 \tau} \quad (12)$$

Hydrodynamic force from planing experiments or reference 3.- For the flat or V-bottom ski,  $f_3$  can be evaluated by means of the theoretical equations in reference 3 (see especially equation (11) in that reference), while for the prismatic bottom of arbitrary cross section experimental planing data obtained with a ski model may be used as in reference 4. In order to make specific solutions of shock-mounted hydro-ski landings, the force term defined by equation (11) is substituted into the equations of motion. Thus equation (5) is replaced by the equation of motion

$$\ddot{z} + \frac{(\dot{z} + \kappa \dot{z}_0)^2}{b C_\Delta} \frac{f_3\left(\frac{z}{b}, \tau, \sigma\right)}{\cos^2 \tau} = 0 \quad (13)$$

where the beam-loading coefficient  $C_\Delta = \frac{M}{\rho b^3}$ .

Solutions may be obtained, by any of the usual numerical methods, for equation (13) in combination with equation (6) for arbitrary spring force or with modifications of equation (6) which incorporate equation (7) for constant spring force or which incorporate equation (8) for linear spring force. One method of solution is illustrated in the appendix of this paper.

Hydrodynamic force from reference 2.- In order to obtain nondimensional solutions of the equations of motion, a simple expression for the vertical hydrodynamic force on an impacting rectangular flat plate must be derived for substitution into equation (13). This expression is obtained from the empirical equation for the planing lift coefficient given in reference 2 as

$$C_L = \frac{F_{V,P}}{\frac{\rho}{2} \dot{x}^2 b^2} = \tau^{1.1} \left[ 0.012 \lambda_w^{1/2} + 0.0095 \left( \frac{\lambda_w}{C_V} \right)^2 \right] \quad (14)$$

where  $\lambda_w$  is defined as the ratio of the mean wetted length to the beam of the model,  $C_V$  is the speed coefficient defined as  $\dot{x}/\sqrt{gb}$ , and  $\tau$  is expressed in degrees. Since values of  $C_V$  encountered in landing impact are usually large, the second term in equation (14) becomes quite small and may be neglected. The hydrodynamic planing force may therefore be expressed as

$$F_{v,p} = 0.006\rho\dot{x}^2b^2\tau^{1.1}\lambda_w^{1/2} \quad (15)$$

Since the equations of motion are written in terms of the time derivatives of  $z$ , it is desirable to write equation (15) in terms of these variables. If the water rise in front of the model is neglected, the error introduced will not be excessive for many applications (see ref. 3) and the mean length-beam ratio may be expressed as

$$\lambda_w \approx \lambda = \frac{z}{b \sin \tau} \quad (16)$$

A combination of equations (12), (15), and (16) yields the value of  $f_z(z/b, \tau, \sigma)$  which upon substitution into equation (11) gives the vertical hydrodynamic force

$$F_v = z^{1/2}(\dot{z} + \kappa\dot{z}_0)^2 \rho b^{3/2} \frac{0.006\tau^{1.1}}{\sin^{5/2}\tau \cos^2\tau}$$

or

$$F_v = z^{1/2}(\dot{z} + \kappa\dot{z}_0)^2 \rho b^{3/2} f(\tau) \quad (17)$$

where  $f(\tau) = \frac{0.006\tau^{1.1}}{\sin^{5/2}\tau \cos^2\tau}$  and  $\tau$  is expressed in degrees.

Substitution of equation (17) into equation (5) results in the equation of motion

$$\ddot{z}' + z^{1/2} (\dot{z}' + \kappa \dot{z}_0)^2 \frac{f(\tau)}{c_{\Delta b}^{3/2}} = 0 \quad (18)$$

Solutions may be obtained by numerical methods for equation (18) in combination with equation (6) for arbitrary spring force or with modifications of equation (6) which incorporate equation (7) for constant spring force or which incorporate equation (8) for linear spring force. One method of solution is illustrated in the appendix.

#### Nondimensional Equations of Motion

Nondimensionalizing the equations of motion allows a large number of specific solutions to be represented by a smaller number of nondimensional plots. In this section nondimensional variables are derived and in the following sections of the paper the arbitrary-, constant-, and linear-spring-force equations are nondimensionalized in that sequence through substitution therein of these new variables.

In the nondimensionalizing process, new dimensionless independent variables are formed through division of the basic independent variables of displacement  $z$  and time  $t$  by physical constants of like dimension. Thus, the nondimensional vertical displacement  $u$  is obtained through division of the displacement  $z$  by the constant  $\eta$  which has the dimension of length, or

$$u = \frac{z}{\eta} \quad (19)$$

and the nondimensional time  $T$  is obtained through division of the time  $t$  by the constant  $\eta/\dot{z}_0$  which has the dimension of time, or

$$T = \frac{t}{\eta/\dot{z}_0} \quad (20)$$

The nondimensional variables of higher order are obtained by taking successive derivatives of the nondimensional displacement with respect to the nondimensional time. Thus, the nondimensional vertical velocity is defined as

$$\dot{u} = \frac{du}{dT} = \frac{du}{dt} \frac{dt}{dT} \quad (21)$$

and the nondimensional vertical acceleration becomes

$$\ddot{u} = \frac{d\dot{u}}{dT} = \frac{d\dot{u}}{dt} \frac{dt}{dT} = \frac{d^2u}{dt^2} \left( \frac{dt}{dT} \right)^2 \quad (22)$$

Since  $\frac{du}{dt} = \frac{\dot{z}}{\eta}$  and  $\frac{dt}{dT} = \frac{\eta}{\dot{z}_0}$ , equation (21) for the vertical velocity can

be restated

$$\dot{u} = \frac{\dot{z}}{\dot{z}_0} \quad (23)$$

and since  $\frac{d^2u}{dt^2} = \frac{\ddot{z}}{\eta}$ , equation (22) for the vertical acceleration can be

restated

$$\ddot{u} = \frac{\ddot{z}\eta}{\dot{z}_0^2} \quad (24)$$

Equations (19), (20), (23), and (24) define the dimensionless variables of the problem which permit nondimensionalization of the equations of motion. An exactly parallel set of equations for  $u'$ ,  $\dot{u}'$ , and  $\ddot{u}'$  may be obtained in terms of the quantities  $z'$ ,  $\dot{z}'$ , and  $\ddot{z}'$ .

Arbitrary-spring-force equations.— Equations (6) and (18) are the equations of motion for the arbitrary-spring-force case. These equations are nondimensionalized through substitution therein of equations (19), (23), and (24) and the primed equivalent expressions. The resulting relations are, from equation (6):

$$\ddot{u}' \pm \psi(\pm \dot{u}' \mp \dot{u})^n + \phi f_1 \left[ \mu(u' - u) \right] = 0 \quad (25)$$

and from equation (18):

$$\ddot{u}' + u^{1/2}(\dot{u} + \kappa)^2 = 0 \quad (26)$$

if the arbitrary constant  $\eta$  is defined as

$$\left[ \frac{c_{\Delta} b^{3/2}}{f(\tau)} \right]^{2/3} \quad (27)$$

and where

$$\psi = c \frac{\dot{z}_0^{n-2}}{M \cos^{n-1} \tau} \quad (28)$$

$$\phi = \frac{\eta \cos \tau}{\dot{z}_0^2 M} \quad (29)$$

$$\mu = \frac{\eta}{\cos \tau} \quad (30)$$

and  $u$  and  $u'$  are functions of  $T$ . (Note, in these and the following generalized expressions, that  $\dot{z}_0 = \dot{z}_0'$ , that  $u_0, u_0', \dot{u}_0,$  and  $\dot{u}_0' = 0$ , and that  $\dot{u}_0 = \dot{u}_0' = 1$ .) Thus the nondimensional motion equations (25) and (26) completely define the time histories of the nondimensional variables  $u, \dot{u}, u', \dot{u}'$ , and  $\ddot{u}'$  in terms of the arbitrary parameters  $n, \eta, \kappa, \psi, \phi$ , and  $\mu$ .

Constant-spring-force equations.— Equations (6), (7), and (18) are the equations of motion for the constant-spring-force case. If equations (19), (23), and (24), the primed equivalents, and equation (27) are substituted into these motion equations the following relations are derived:

$$\ddot{u}' \pm \psi(\pm \dot{u}' \mp \dot{u})^n + \delta = 0 \quad (31)$$

and (eq. (26))

$$\ddot{u}' + u^{1/2}(\dot{u}' + \kappa)^2 = 0$$

where

$$\delta = H \frac{\eta \cos \tau}{M \dot{z}_0^2} \quad (32)$$

Equations (31) and (26) completely define the dimensionless time histories for the constant-spring-force case.

Linear-spring-force equations.— The equations of motion for the linear-spring-force case are nondimensionalized exactly as were the constant-spring-force equations, with the result that equations (6) and (8) become

$$\ddot{u}' \pm \psi(\pm \dot{u}' \mp \dot{u})^n + \theta(u' - u) = 0 \quad (33)$$

and equation (18) becomes equation (26):

$$\ddot{u}' + u^{1/2}(\dot{u}' + \kappa)^2 = 0$$

where

$$\theta = K \frac{\eta^2}{\dot{z}_0^2 M} \quad (34)$$

Equations (33) and (26) completely define the dimensionless time histories for the linear-spring-force case.

A numerical step-by-step procedure for obtaining solutions of any of the foregoing sets of equations of motion is described in the appendix.



## DISCUSSION OF NONDIMENSIONAL SOLUTIONS

In order to provide trend studies for use in preliminary design of shock-mounted hydro-skis, solutions were made of equations (26) and (33) on a Reeves Electronic Analog Computer for a wide range of parameters. The equations for the linear-spring-force case were chosen since they were easier to handle than the constant-spring-force equations and since preliminary solutions indicated that differences in the results between the linear- and constant-spring-force cases and the exact air-spring case were small in the practical region. The value of 2 was selected for the damping exponent  $n$ . In order to apply these solutions to a practical problem, a set of scale factors may be obtained by evaluating equation (27) in terms of the constants of the actual problem. New scales may be computed for any given aircraft and written in over the existing scales on the plots of figures 2, 3, 4, and 5. The parameters  $\kappa$ ,  $\psi$ , and  $\theta$  may be evaluated for the cases of interest by substitution of the appropriate approach conditions and design constants into equations (4d), (28), and (34).

Figure 2 presents nondimensional acceleration time histories for most of the region embraced by the values of  $\kappa$ ,  $\psi$ , and  $\theta$  from 0.1 to 100 and  $n$  equal to 2. These curves give the variation of the acceleration of the aircraft normal to the undisturbed water surface for different approach conditions and shock-strut spring and damping constants. The general trends which are apparent are as follows.

(a) The effect on the acceleration of varying the damping constant  $\psi$  becomes smaller as  $\theta$  increases, since the ratio of the spring force to damping force increases.

(b) The acceleration time history has the appearance of a combination of two separate curves. One, arising from the strut damping reaction, has an early peak, and the other, arising from the strut spring reaction, has a later peak. This is reasonable since the highest strut compression velocity occurs early in the impact, making for large damping force, while the maximum strut compression displacement occurs later in the impact, giving the large spring force. For intermediate spring and damping reactions the peaks approach equal heights, resulting in a flat-topped or rectangular force curve.

(c) As  $\kappa$  increases (approaching the planing condition) the effect on the acceleration of varying  $\psi$  is increased over that of varying  $\theta$ . This probably is the result of very small strut compression displacements at substantial compression velocities.

The maximum values of the dimensionless acceleration  $-\ddot{u}'$  are plotted against the damping parameter  $\psi$  in figure 3 for the different

values of spring parameter  $\theta$  and the approach parameter  $\kappa$ . The damping parameter rather than the spring parameter was chosen as the abscissa since damping is usually the more important factor in shock-strut design. For a given aircraft at a given trim and vertical velocity at contact, the scale values on the plots of figures 3, 4, and 5 can be used directly for depicting relative trends of the dimensional quantities, as their magnitudes bear the correct ratios to each other. For example, in figure 3 the acceleration is proportional to  $-\ddot{u}'$ , the spring constant to  $\theta$ , and the damping constant to  $\psi$ , while  $\kappa$  approximates  $\tau/\gamma_0$  for the low trim angles.

From this figure it is evident that, in general, the maximum acceleration increases with the spring constant and the damping constant and decreases with increasing flight-path angle. From a dimensional viewpoint this last result may be explained by assuming the above conditions of constant initial vertical velocity and trim, for which a reduction in  $\gamma_0$  would mean an increase in resultant velocity at contact with correspondingly larger loads.

The effect of variation of shock-strut and approach parameters on the vertical velocity at water exit, which affects the severity of subsequent impacts, may be observed from figure 4. It does not appear that any general comment can be made regarding the trends in this figure, although such trends would probably become more pronounced for a given aircraft with its more restricted practical range of  $\kappa$ ,  $\theta$ , and  $\psi$ .

An idea of the required shock-strut length for an aircraft may be obtained by means of figure 5. This figure presents the maximum strut stroke utilized in impacts for the ranges of  $\kappa$ ,  $\theta$ , and  $\psi$  covered by the previous figures. The general trends apparent from figure 5 are that the strut stroke decreases with increasing damping constant, spring constant, and initial flight-path angle. The decrease with increasing flight-path angle is probably a result of the lower loads arising from the reduction in horizontal velocity occurring at the higher flight-path angles. From the foregoing figures the designer may reach the best engineering compromise between a rectangular shock-strut force-time curve, minimum rebound velocity from the water surface, and shortest required strut stroke.

#### CONCLUDING REMARKS

Theoretical equations have been derived for treating oblique water impacts of an aircraft equipped with a flat-plate hydro-ski mounted on a shock strut. These equations were nondimensionalized and solved, and the results were plotted for the case of velocity-squared damping and a linear spring reaction for a wide range of design parameters. On these plots the following trends may be observed.

A tendency toward a double peak exists on the acceleration time histories, mainly because of shock-strut characteristics. The early peak results principally from the large damping force at high initial telescoping velocity while the later one results principally from the large spring force at large telescoping deflection.

The effect on the acceleration time history of varying the damping constant becomes smaller as the spring constant is increased.

The effect on the acceleration time history of variation of the damping constant becomes greater than the effect of variation of the spring constant as the initial flight-path angle is decreased.

For a given initial vertical velocity and trim, the maximum acceleration increases with the spring and damping constants and decreases with increasing flight-path angle. Also the required strut stroke decreases with increasing damping constant, spring constant, and initial flight-path angle.

Langley Aeronautical Laboratory,  
National Advisory Committee for Aeronautics,  
Langley Field, Va., July 27, 1954.

## APPENDIX

## NUMERICAL SOLUTION OF EQUATIONS OF MOTION

The equations of motion derived in the body of this paper may be solved by any of the standard numerical procedures (refs. 5 and 6). One such step-by-step process involving incremental linear extrapolation of vertical velocity with a correction to this velocity at each step is described below. In order to avoid duplication, any of the sets of equations proposed in this paper can be replaced by two equivalent expressions for which the numerical procedure is set up. These expressions are as follows:

$$\ddot{v}' + f_4(v)(\dot{v} + \kappa\dot{v}_0)^2 = 0 \quad (A1)$$

and

$$\ddot{v}' \pm A(\pm\dot{v}' \mp \dot{v})^n + f_5(v' - v) = 0 \quad (A2)$$

where  $v$  and  $v'$  are functions of some sort of time, say  $t$ , for example. In these equations  $v$ ,  $\dot{v}$ , and  $\ddot{v}$  are, respectively, the displacement, velocity, and acceleration of the ski normal to the water surface while the primed equivalents refer to the fuselage motions. These equations are used for illustrative purposes and the actual solutions should be carried out with the specific equations of the problem after the proper functions have been evaluated and substituted therein.

The step-by-step computation can be carried out by selecting several successive values of  $\dot{v}$  designated  $\dot{v}_a$ ,  $\dot{v}_b$ , and  $\dot{v}_c$  for values of time  $t$  separated by increments designated  $\Delta t$ . The values of  $\dot{v}_a$  and  $\dot{v}_b$  will be considered known from previous steps or from initial values of the variables. Since  $\ddot{v}_0 = 0$ , the velocity can be assumed to be constant over the first increment; hence  $\dot{v}_a = \dot{v}_b = \dot{v}_0$ . It is desired to obtain successive values of some of the derivatives of  $v$  and  $v'$  with respect to  $t$ , and especially accurate values of  $\dot{v}_c$  since this quantity is extrapolated. The equations selected to accomplish this are

$$\dot{v}_x = 2\dot{v}_b - \dot{v}_a \quad (A3)$$

$$v_c = v_b + \frac{\dot{v}_x + \dot{v}_b}{2} \Delta t \quad (A4)$$

$$\ddot{v}_c' = -f_4(v_c)(\dot{v}_x + \kappa\dot{v}_0)^2 \quad (A5)$$

$$\dot{v}_c' = \dot{v}_b' + \frac{\ddot{v}_c' + \ddot{v}_b'}{2} \Delta t \quad (A6)$$

$$v_c' = v_b' + \frac{\dot{v}_c' + \dot{v}_b'}{2} \Delta t \quad (A7)$$

$$\dot{v}_c = \dot{v}_c' \mp \left[ \frac{\mp \ddot{v}_c' \mp f_5(v_c' - v_c)}{A} \right]^{1/n} \quad (A8)$$

where  $x$  indicates a trial value at point  $c$  obtained through extrapolation, and the upper and lower signs refer, respectively, to strut compression and extension. A switch is made from the upper to the lower signs when  $\dot{v}'$  becomes equal to or less than  $\dot{v}$ .

The value of  $\dot{v}_c$  is the required accurate value which for the next increment becomes  $\dot{v}_b$ , the previous  $\dot{v}_b$  becoming  $\dot{v}_a$ . Although the operations carried out with equations (A3) to (A8) could be repeated for the same increment of time  $\Delta t$  with  $\dot{v}_c$  substituted for  $\dot{v}_x$ , one correction for each step is believed to be sufficient, provided a small enough incremental time is chosen. For many applications, it is believed advisable to select very small increments for the first four or five steps and larger increments from there on, although it must be remembered that in all cases the time increment from  $a$  to  $b$  must equal the time increment from  $b$  to  $c$ .

The correct increment size may be established by experience acquired in making several solutions for a given problem and using different increment sizes for each solution. The increment size may be increased until the point is reached where the solutions diverge from the more accurate curve obtained with a very small increment size. If a small-period oscillation is present in the curve, too large an increment size is also indicated. The values determined from the repeated application of equations (A3) to (A8) when plotted against  $t$  give the motions of the ski and fuselage throughout the impact.

If it is assumed that a dump valve exists in the shock absorber, then the damping on strut extension becomes considerably less than on compression. When this condition exists, the value of  $A$ , and possibly of  $n$  also, will become different during the extension part of the stroke.

## REFERENCES

1. Schnitzer, Emanuel: Estimation of Water Landing Loads on Hydro-Ski-Equipped Aircraft. NACA RM L53D29, 1953.
2. Korvin-Kroukovsky, B. V., Savitsky, Daniel, and Lehman, William F.: Wetted Area and Center of Pressure of Planing Surfaces. Preprint No. 244, S.M.F. Fund Paper, Inst. Aero. Sci. (Rep. No. 360, Project No. NRO62-012, Office Naval Res., Exp. Towing Tank, Stevens Inst. Tech., Aug. 1949.)
3. Schnitzer, Emanuel: Theory and Procedure for Determining Loads and Motions in Chine-Immersed Hydrodynamic Impacts of Prismatic Bodies. NACA Rep. 1152, 1953. (Supersedes NACA TN 2813.)
4. Smiley, Robert F.: The Application of Planing Characteristics to the Calculation of the Water-Landing Loads and Motions of Seaplanes of Arbitrary Constant Cross Section. NACA TN 2814, 1952.
5. Scarborough, James B.: Numerical Mathematical Analysis. Second ed., The Johns Hopkins Press (Baltimore), 1950.
6. Levy, H., and Baggott, E. A.: Numerical Solutions of Differential Equations. First Am. Ed., Dover Pub. Inc., 1950.

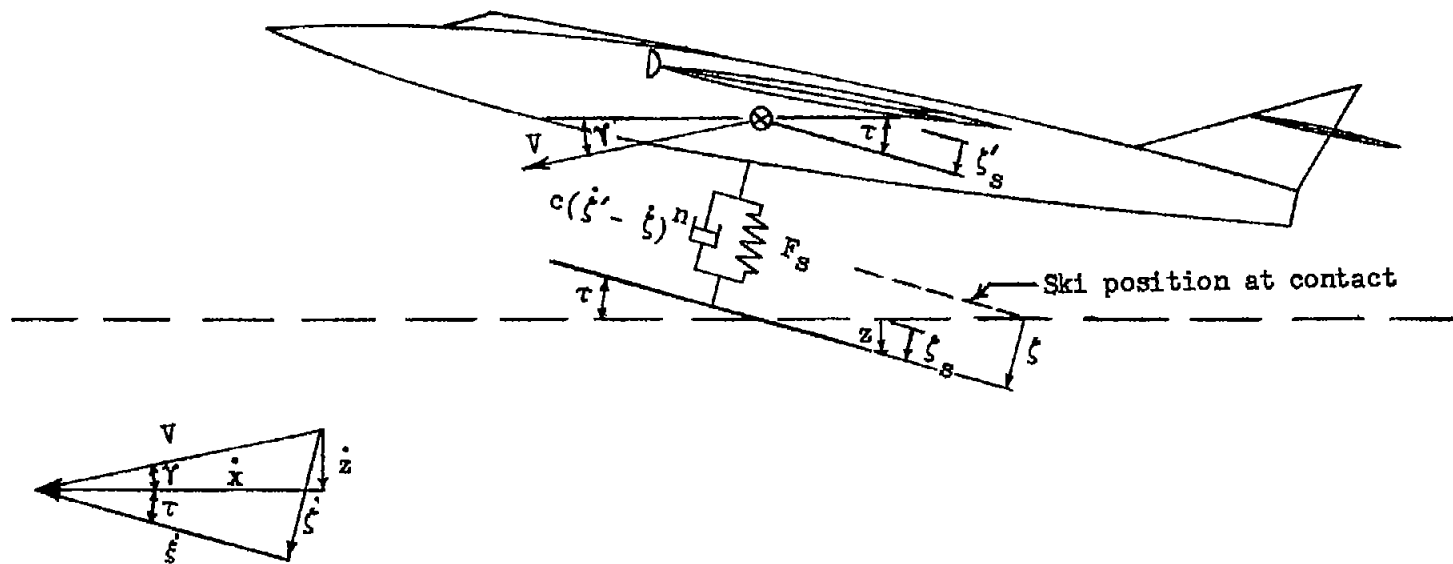

Velocity relations

Figure 1.- Impact geometry.

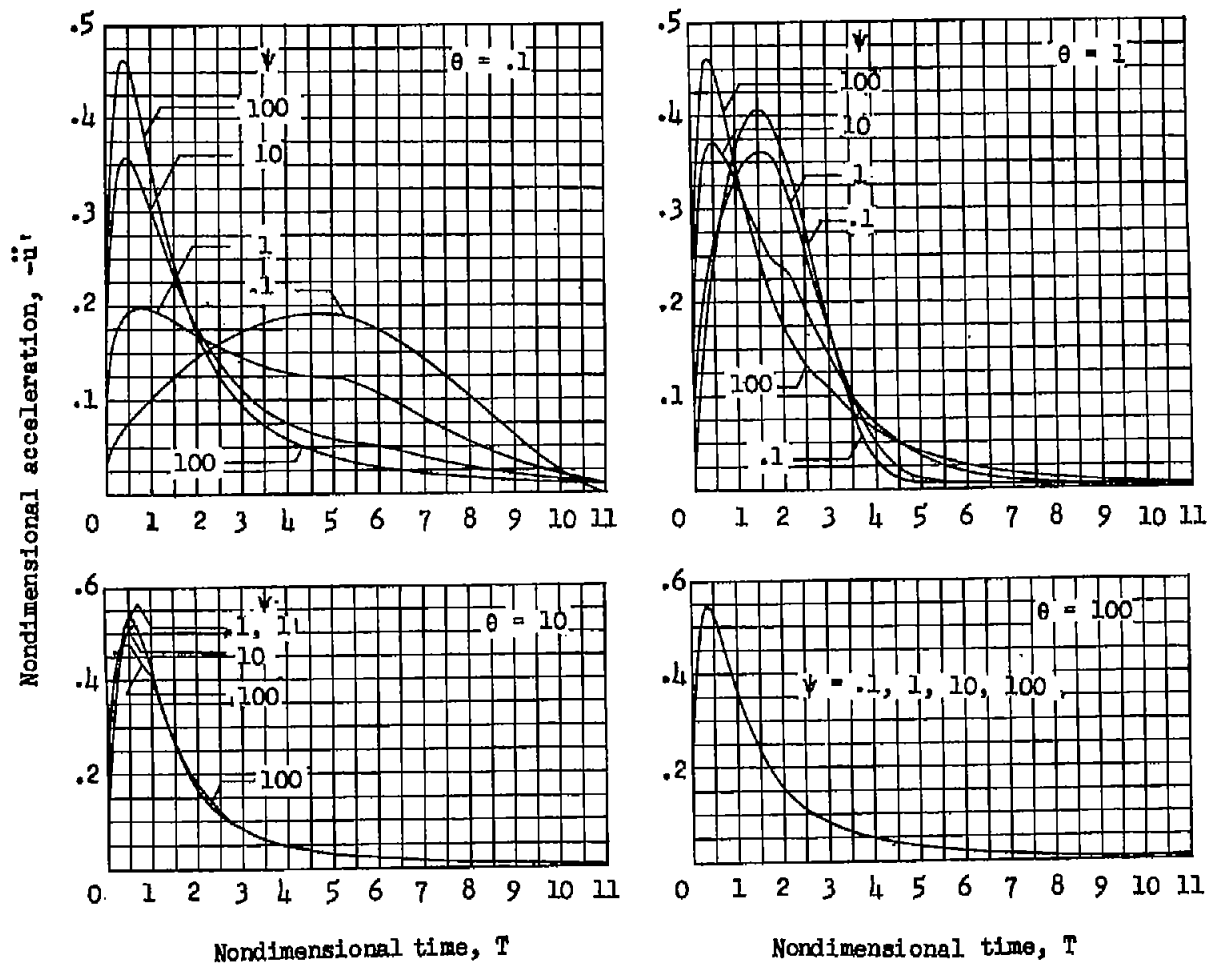

(a)  $\kappa = 0.1$ .

Figure 2.- Nondimensional acceleration time histories for various values of the spring parameter  $\theta$ , the damping parameter  $\psi$ , and the approach parameter  $\kappa$ , with the damping exponent  $n = 2$ .



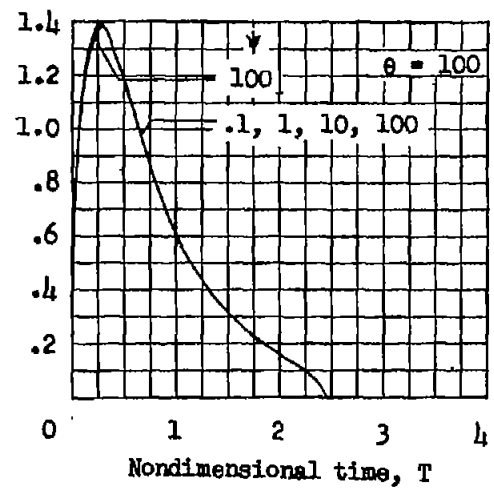
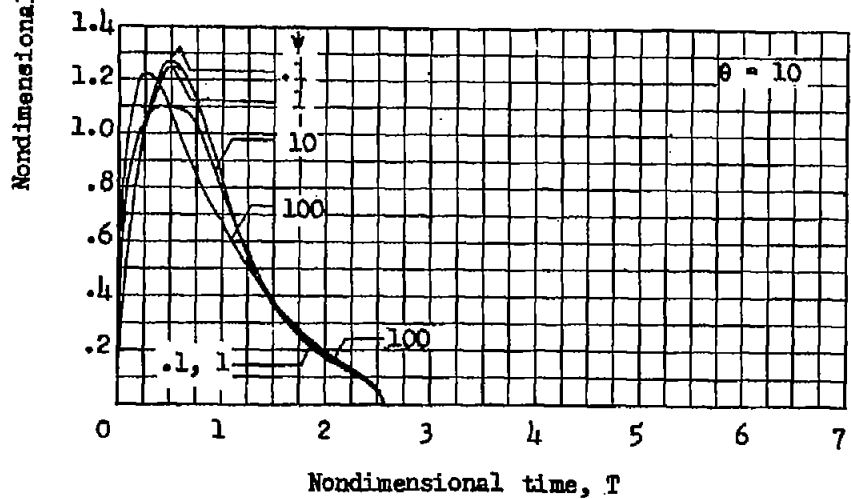
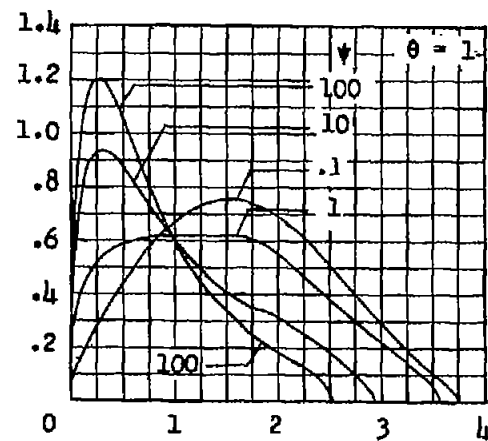
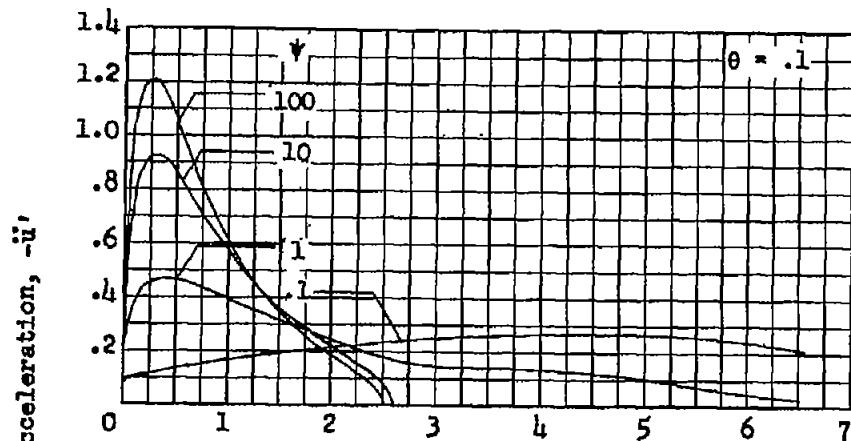

(b)  $\kappa = 1$ .

Figure 2.- Continued.

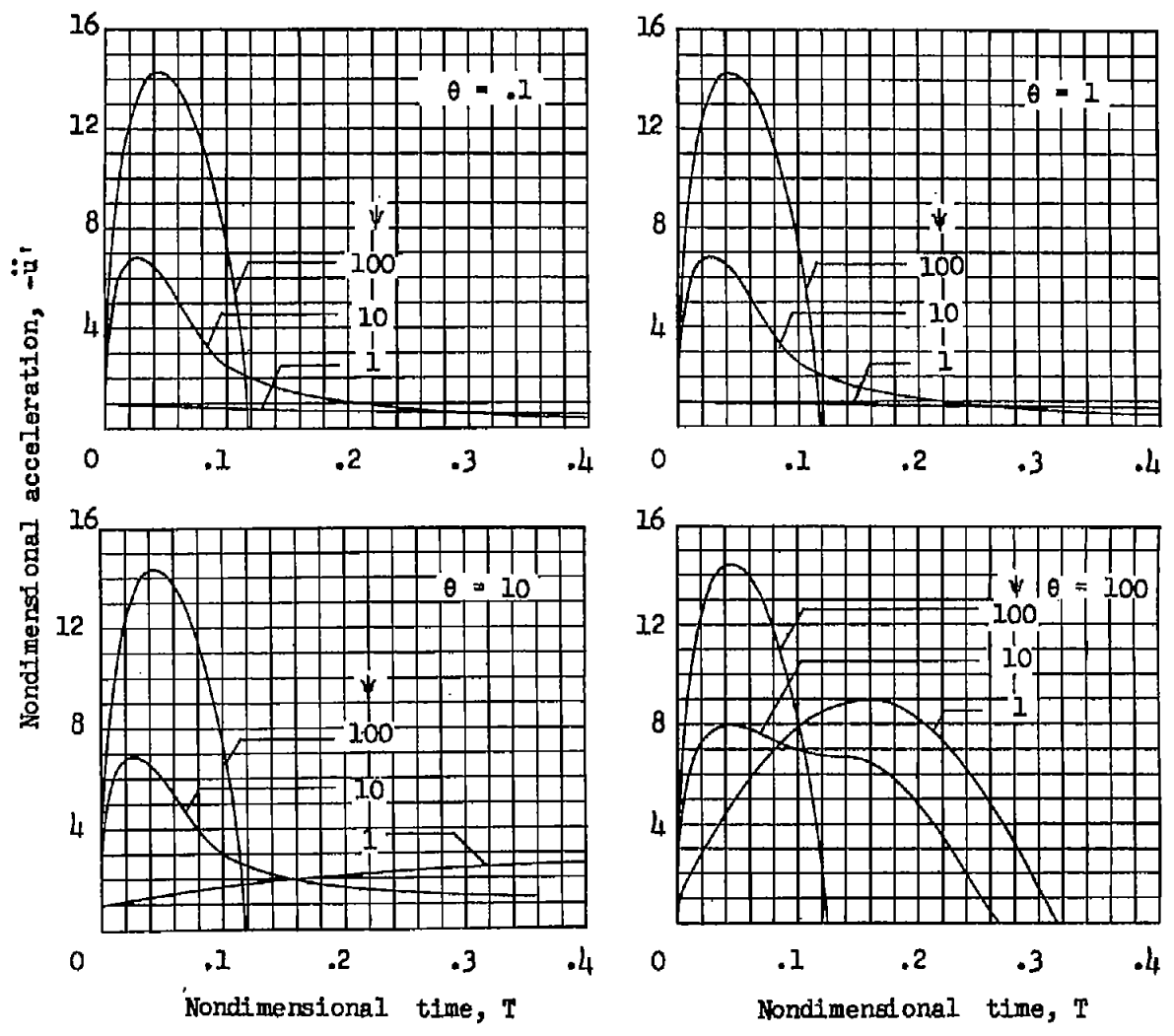

(c)  $\kappa = 10$ .

Figure 2.- Continued.

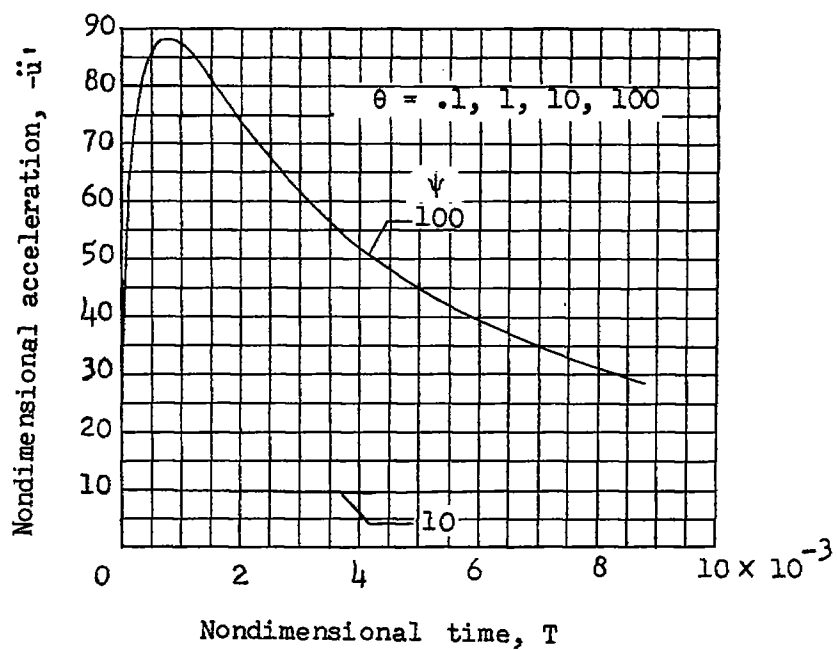

(d)  $\kappa = 100$ .

Figure 2.- Concluded.

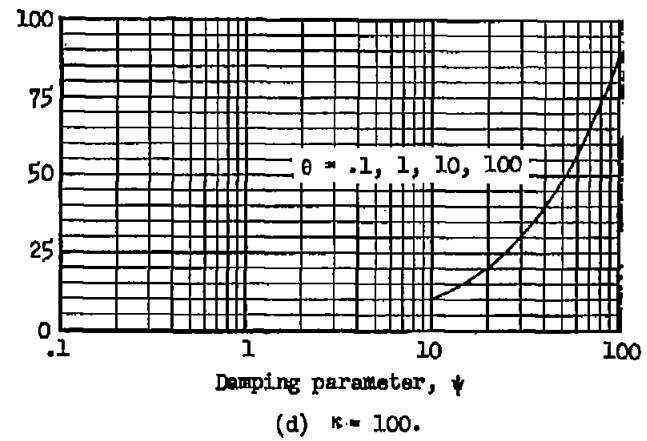
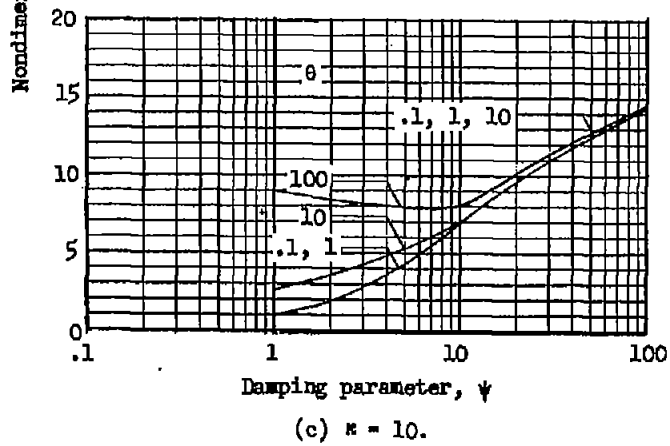
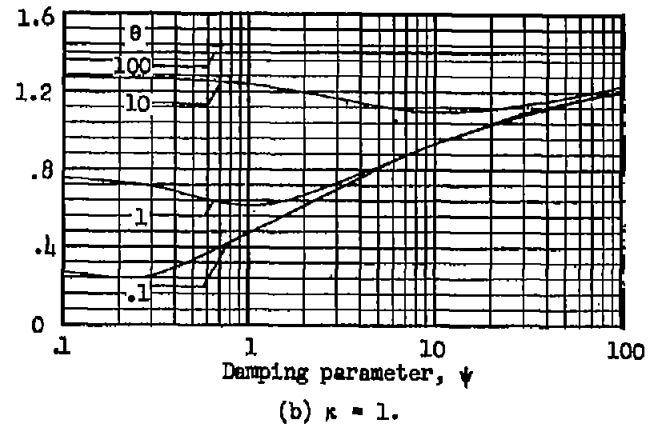
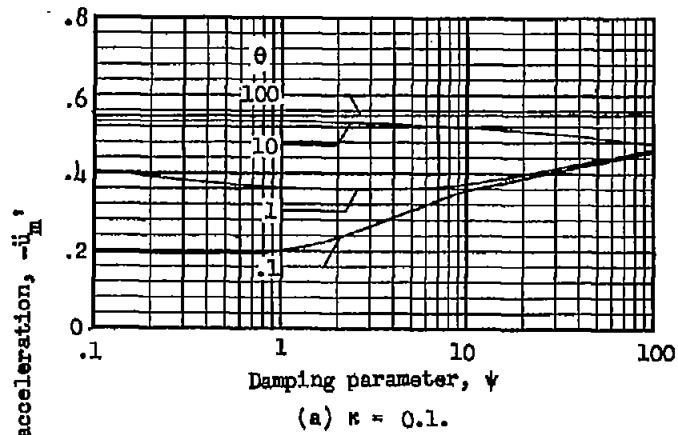

Figure 3.- Variation of maximum nondimensional acceleration with damping parameter  $\psi$  and spring parameter  $\theta$  for different values of the approach parameter  $\kappa$ , with the damping exponent  $n = 2$ .

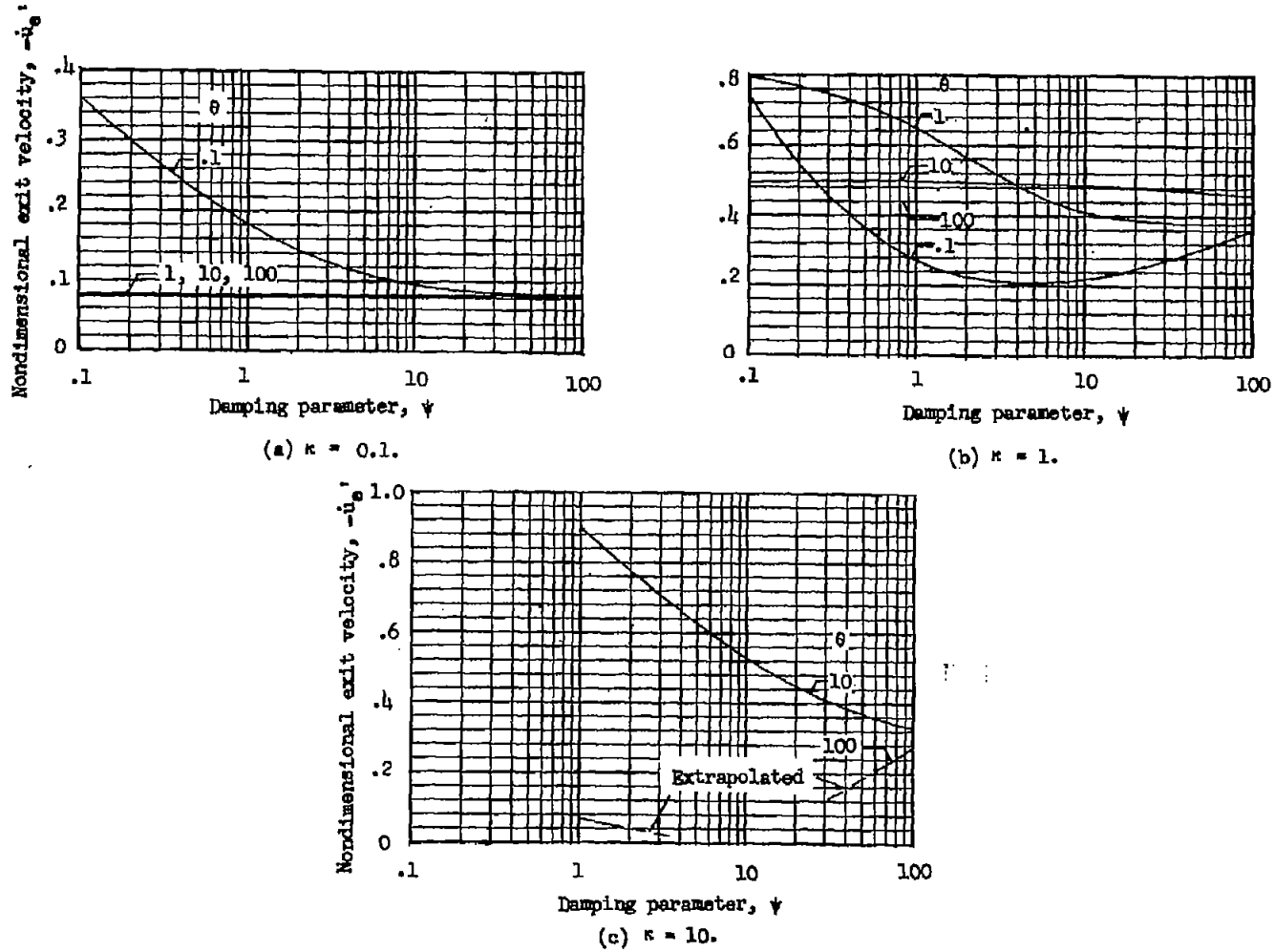

Figure 4.- Variation of nondimensional exit velocity with damping parameter  $\psi$  and spring parameter  $\theta$  for different values of the approach parameter  $\kappa$ , with the damping exponent  $n = 2$ .

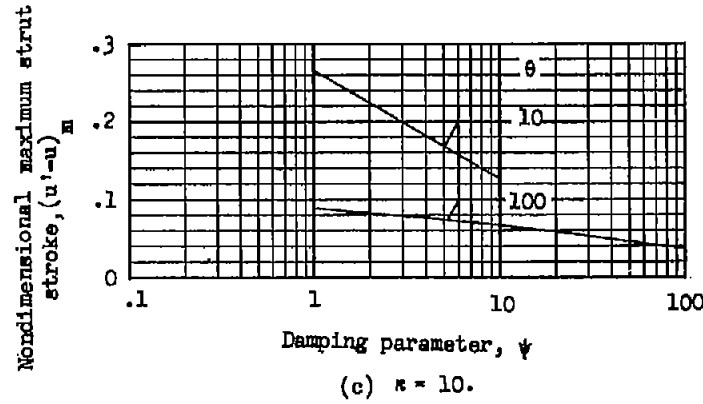
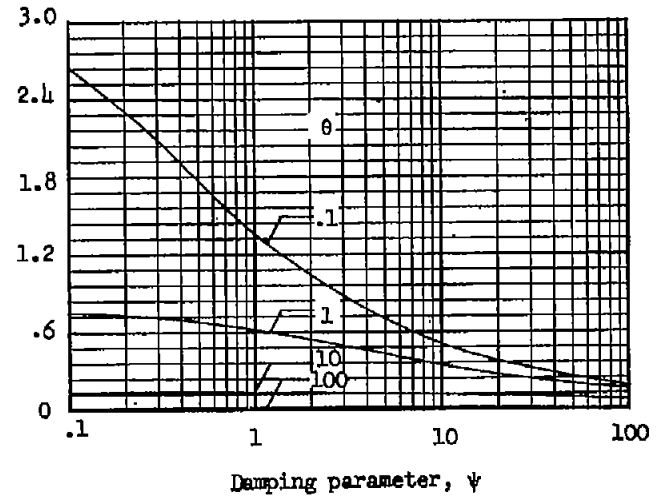
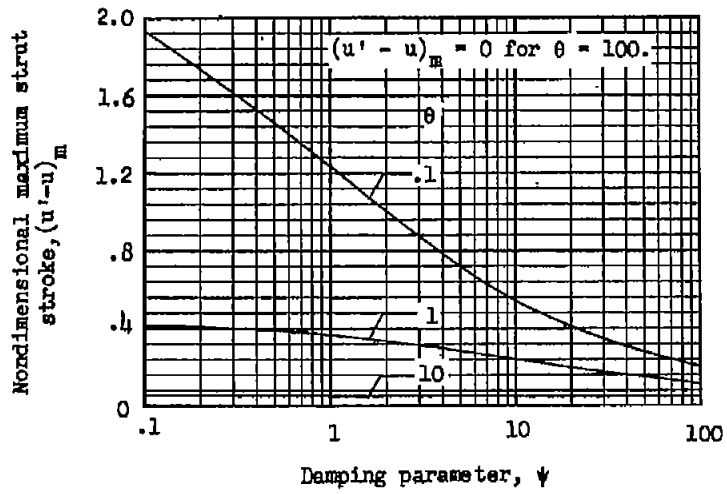

Figure 5.- Variation of nondimensional maximum strut stroke with damping parameter  $\psi$  for various values of the spring parameter  $\theta$  and the approach parameter  $\kappa$ , with the damping exponent  $n = 2$ .