

HDOI 4

~~CONFIDENTIAL~~

Copy 3
RM L5'

TECH LIBRARY KAFB, NM
DL44799

20 JAN 1958
1491
14771

NACA RM L57112

7804

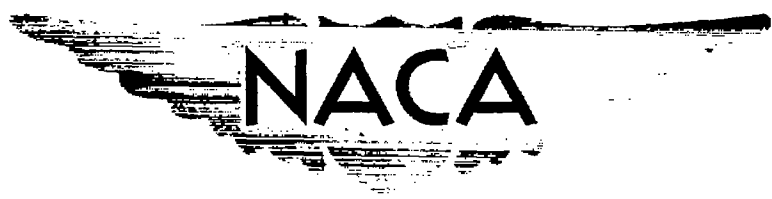

RESEARCH MEMORANDUM

LIMITED TESTS OF MOLYBDENUM COATED WITH MOLYBDENUM
DISILICIDE IN A SUPERSONIC HEATED-AIR JET
AND BRIEF DESCRIPTION OF THE
COATING FACILITY

By E. M. Fields and N. T. Wakelyn
Langley Aeronautical Laboratory
Langley Field, Va.

CLASSIFIED DOCUMENT

This material contains information affecting the National Defense of the United States within the meaning of the espionage laws, Title 18, U.S.C., Secs. 793 and 794, the transmission or revelation of which in any manner to an unauthorized person is prohibited by law.

NATIONAL ADVISORY COMMITTEE FOR AERONAUTICS

WASHINGTON
January 9, 1958

~~CONFIDENTIAL~~

no. 1 or changed to Unclassified)

of NASA Tech. Pub. Announcement #14
(OFFICER AUTHORIZED TO CHANGE)

By 3 Mar 60
NAME AND

NIC
(GRADE OF OFFICER MAKING CHANGE)

21 Feb. 61
DATE



0144799

Z NACA RM L57112

~~CONFIDENTIAL~~

NATIONAL ADVISORY COMMITTEE FOR AERONAUTICS

RESEARCH MEMORANDUM

LIMITED TESTS OF MOLYBDENUM COATED WITH MOLYBDENUM
DISILICIDE IN A SUPERSONIC HEATED-AIR JET
AND BRIEF DESCRIPTION OF THE
COATING FACILITY

By E. M. Fields and N. T. Wakelyn

SUMMARY

A laboratory-scale vapor-deposition coating facility has been constructed and used in basic research in the field of high-temperature coatings. The vapor-deposition coatings were produced by the hydrogen reduction of halides and not by vacuum plating methods.

A molybdenum disilicide coating applied to molybdenum by the vapor-deposition process has been tested at a Mach number of approximately 2 in a hot-air jet having a stagnation temperature of about 3,500° to 4,000° F. A coated model reached an equilibrium temperature of about 3,100° F and was undamaged after 470 seconds at this temperature in the jet, while an uncoated model was virtually destroyed in less than 6 seconds.

INTRODUCTION

A number of metallic materials that have high melting temperatures and considerable strength remaining at elevated temperatures are not suited to high-temperature use in air because of oxidation. One of the most promising of these high-temperature metals is molybdenum with a melting temperature of about 4,700° F, a 0.2-percent-offset yield strength of 20,000 to 30,000 pounds per square inch at 2,000° F (ref. 1), and limited machinability and formability (ref. 2). Molybdenum, however, oxidizes rapidly in air above 1,300° F (ref. 1) and thus is not suitable for high-temperature use in air unless a protective coating is used to prevent oxidation. Research into the high-temperature behavior of oxidation-protected molybdenum has been carried on for a number of

~~CONFIDENTIAL~~

years, particularly in the use of molybdenum in ram jets and turbines. (See, for example, refs. 3 to 8.)

A program is under way at the Langley Pilotless Aircraft Research Division for the study of vapor-deposition coating methods (hydrogen reduction process). The program is concerned with research in the field of high-temperature vapor-deposition coatings and the behavior of these coatings in high-temperature environments. A laboratory-scale vapor-deposition facility has been constructed and the first coating (molybdenum disilicide on molybdenum) was achieved in May 1957. The coating process and facility are described in a subsequent section of the present report.

One of the more notable protective coatings for molybdenum is molybdenum disilicide. Small molybdenum wires coated with MoSi_2 have lasted for as long as 100 hours at $3,000^\circ\text{F}$ in still air (ref. 9). The present report shows the results of limited tests of dime-sized molybdenum disks (uncoated and coated with molybdenum disilicide) at a Mach number of approximately 2 in a hot-air jet having a maximum stagnation temperature of about $4,000^\circ\text{F}$.

SYMBOLS

A	angstrom
H_2	hydrogen
HCl	hydrogen chloride
M	Mach number
Mo	molybdenum
MoSi_2	molybdenum disilicide
NaOH	sodium hydroxide
SiCl_4	silicon tetrachloride
T_s	stagnation temperature, $^\circ\text{F}$

MODELS, TESTS, AND TEST RESULTS

Models

The models were $\frac{21}{32}$ -inch-diameter disks punched from a 0.03-inch-thick sheet of sintered (99.9-percent pure) molybdenum. Figure 1 shows photographs and a sketch of the models before testing. The models were cemented to the zirconia holder with Sauereisen low-expansion cement (no. 29) and the entire assembly was cured at 250° F for 24 hours. One side of the molybdenum sheet, from which the models were punched, had been polished to a bright satin finish, and the coatings deposited on the polished side were tested.

Three coated models differing only in the coating time were prepared. As shown in table I and figure 2, the weight and thickness of the coated models increased with increased coating time. Since, in the MoSi₂ coating, the silicon atoms migrate into the molybdenum crystals (fig. 3), the measured coating thickness is not the true thickness. The models were coated on both sides and on the edges. The coatings on the edges were rougher (and appeared to be thicker) than the coating on the flat surfaces.

The MoSi₂ coating was formed on the molybdenum by mixing gaseous silicon tetrachloride with a suitable carrier and a reducing agent and flowing the mixture over the heated molybdenum. The resulting coating was identified as MoSi₂ through X-ray diffraction.

Tests

The tests were run in a laboratory-scale ceramic-heated air jet in which air is passed through a preheated bed of zirconia spheres and exhausted to the atmosphere as an $M \approx 2$ axisymmetric free jet (ref. 10). This heated free jet has an exit diameter of 0.78 inch and a stagnation pressure of approximately 100 pounds per square inch absolute. The stagnation (bed) temperatures for the present tests were about 4,000° F at the beginning and about 3,500° F at the end of each run. Each run lasted about 90 seconds. The typical variation of stagnation (bed) temperature with running time in the heated air jet is shown in reference 11.

The stagnation temperatures shown in the present report are the temperatures at the top of the bed of zirconia spheres. Limited measurements of the air stagnation temperatures up to 3,000° F have been

made and, in general, the air stagnation temperatures have been within 100° F of the temperatures of the top of the bed.

Figure 4 shows the temperature time history of run 1 of model 27 as measured with a platinum--platinum-rhodium thermocouple spot-welded to the back surface of the model. The model back-surface temperature began rising within 0.03 second after the model reached the center of the jet and reached an essentially steady-state temperature of 3,080° F in about 12 seconds.

Test Results

Four identical uncoated models and three coated models with different coating thicknesses were tested in the hot-air jet. The results of the tests are shown in figure 5 and table II. The cement used to attach one of the coated models (model 26) to the holder failed during the first run, and no data of significance were obtained for this model.

Uncoated models.- The four uncoated models were tested for different lengths of time in order to observe the surface conditions of the models at different times during the test. Model 4 was tested first to establish the time for major damage to the uncoated model and models 1, 2, and 3 were tested for shorter times as indicated in figure 5(a). After 3.0 and 3.3 seconds of testing (models 1 and 2, respectively), visual examination of the surface did not show any detectable surface erosion but the surface was discolored with the characteristic blue-black of oxidized molybdenum. After 4.7 seconds of testing (model 3) considerable surface deterioration resulted, and after 5.7 seconds of testing (model 4) the uncoated molybdenum was virtually destroyed. Motion pictures of the tests show that, at 4.1 seconds, models 3 and 4 flared up with what appeared to be a shower of sparks and incandescent gases, and model destruction proceeded at a very rapid rate accompanied by a steady shower of incandescent small particles.

The apparent "melting" of the uncoated molybdenum, at a jet stagnation temperature considerably lower than the melting temperature of molybdenum, is probably due to oxidation of the molybdenum. Other investigators have reported low-temperature "melting" of molybdenum (ref. 11, for example).

Coated models.- The results of tests for the coated models are shown in figures 5(b) and 5(c) and table II. The models were tested in runs of about 90 seconds each. The 90-second run duration was chosen in order to limit the stagnation temperature drop to about 500° to 600° F during the run and to insure an uninterrupted camera record of each run. The time between runs was usually about 20 to 30 minutes and the model cooled naturally to near room temperature between runs.

Models 25 and 27 were nominally identical except for coating thickness. By using the total measured thickness gain (both sides; see table I) and assuming that both sides had about the same coating thickness, it was estimated that the thickness of the coating on one side was approximately 0.0015 to 0.0020 inch for model 25 and approximately 0.0010 to 0.0015 inch for model 27.

The total test times of approximately 285 seconds for model 27 and approximately 632 seconds for model 25 shown in figure 5 represent the total time in the jet and include the transient heating time at the beginning of each run. Table II includes additional test results. Motion pictures of the tests show that model 27 began to burn vigorously at one point on the edge at 7 seconds of run 4 (277 seconds testing time) and was flaming steadily over about one-half its area in 8 more seconds (285 seconds testing time). Model 25 was undamaged as determined from visual inspection at the end of run 6 (541 seconds testing time) and the motion pictures of run 7 do not show when the first damage occurred. At the end of run 7 (632 seconds testing time) visual inspection revealed the hole burned through the model at the stagnation point. Model 25 did not exhibit the usual flaming destruction of molybdenum at any time during run 7.

Figure 5(c) shows that the surface of model 25 appears to be blistered over part of the undamaged area. These "blisters" are small particles of zirconia powder thrown out by the jet during the testing of model 25. The jet is normally clean and not contaminated with foreign particles until several hours of testing time have been accumulated. As soon as it is determined that foreign particles are contaminating the jet because of partial breakup of the zirconia burner-inlet blocks, the facility is partially dismantled and cleaned. Model 25 was tested immediately prior to dismantling of the facility for cleaning.

A thermocouple record of run 1 of model 27 (see fig. 4) showed that the model took about 12 seconds to reach an essentially steady-state temperature of about 3,100° F during the run. Thus, model 27 was at about 3,100° F for approximately 234 seconds of the 285-second testing time and model 25 was at about 3,100° F for at least 470 seconds of the 632-second testing time without apparent damage (run 7 of model 25 not considered). These times compare favorably with approximately 4 seconds for the uncoated models before destruction began.

~~CONFIDENTIAL~~

DESCRIPTION OF THE VAPOR-DEPOSITION PROCESS AND FACILITY

General

Vapor-deposited coatings of many of the simple refractory materials (including molybdenum disilicide) have been known for many years. (See ref. 9.) In the vapor-deposition process the coating material, in vapor form, is brought into contact with a heated base material, and a chemical reduction or a thermal decomposition of the coating material, occurring at the surface of the base, produces the coating.

A laboratory-scale vapor-deposition facility (see fig. 6) has been constructed at the Langley Pilotless Aircraft Research Division, and the first coating MoSi_2 was achieved in May 1957. The function of this facility is to aid in research into the nature of vapor-deposited high-temperature coatings and the behavior of these coatings in high-temperature environments.

Formation of Molybdenum Disilicide

Hydrogen reduction of the halide, silicon tetrachloride, was used to produce the molybdenum disilicide coating. The reduction reaction which deposits silicon upon the surface of a molybdenum model and the subsequent diffusion of the silicon into the molybdenum to produce the disilicide coating may be represented as follows:

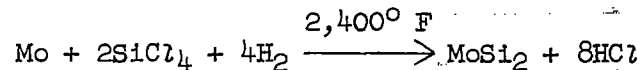

Necessary chemicals and their preparation.- A molybdenum model, a gaseous reducing agent, an inert carrier gas, and a low-boiling silicon halide were used in the formation of the molybdenum disilicide coating. The reducing agent and the carrier gas were hydrogen and argon, respectively, and were chosen because of their purity and availability. Hydrogen is not used as the carrier since it would cause deposition of the silicon before the coating mixture reached the model. Silicon tetrachloride was used as a source of silicon because it is readily reduced by hydrogen, is commercially available in sufficiently pure form, and its vapor pressure at room temperatures is high enough for it to be entrained easily by the argon carrier.

It is stated in reference 9 that porous and brittle deposits result from the presence of oxygen and water vapor in the gases. The hydrogen gas was purged of oxygen by means of a Deoxo Hydrogen Purifier (see fig. 6) which employs a palladium catalyst so that any oxygen present

~~CONFIDENTIAL~~

reacts with the hydrogen to produce water. Downstream of the Deoxo unit is a desiccating column filled with Drierite (anhydrous calcium sulfate). The argon gas was purged of oxygen with a Fisher-Milligan Gas Washer (see fig. 6) filled with a basic solution of pyrogallol. This oxygen purger is also followed by a desiccating column of Drierite. The silicon tetrachloride was technical grade and was used without further purification.

Formation of the reaction mixture.- The two gases arrive at the vaporizer unit (fig. 6) purged of oxygen and water vapor. This unit, which contains the silicon tetrachloride, is a 100-ml triple-necked distilling flask with standard-taper ball-and-socket joints. The argon gas enters the vaporizer unit and bubbles through the silicon tetrachloride. The mixture of argon and silicon tetrachloride vapor thus formed flows through the middle neck of the vaporizer unit to a three-way Teflon valve (experience has indicated that glass and metal valves "freeze" in the presence of SiCl_4) in a T-tube where it joins the hydrogen stream. The reactants were thus combined just before entering the reaction tube (fig. 6(b)), which contained the heated molybdenum model.

Deposition temperature.- Molybdenum disilicide can be formed at model temperatures from approximately $1,800^\circ$ to $3,300^\circ$ F (refs. 1 and 9). At the beginning of the project a carbon-tube furnace, capable of attaining a temperature of over $4,000^\circ$ F, was used to produce the temperature environment necessary for the deposition of silicon and for its diffusion into the molybdenum. Although coatings were obtained with the use of this furnace, evidence of carbon contamination in the molybdenum disilicide coating was discovered. Because of this carbon contamination, an induction-type heater ($3\frac{1}{2}$ kilovolt-amperes) was used for the subsequent coatings.

Several sizes and shapes of load coils were tried. Some were able to heat the models up to about $2,600^\circ$ F, but with the passage of hydrogen over the model, the temperature of the model fell below the coating limit. A coil shaped around a specially formed quartz reaction tube (fig. 7) proved capable of heating the dime-sized molybdenum models to temperatures higher than $3,200^\circ$ F; upon passage of hydrogen through the apparatus, a drop in model temperature to approximately $2,400^\circ$ F was experienced. This temperature is well within the coating limit.

The model temperatures were measured with both a platinum-platinum-rhodium thermocouple and an optical pyrometer. During the later runs it was found that temperature measurements made with the optical pyrometer were sufficiently accurate to be relied upon exclusively.

The coating process.- On the average, 1.8 liters of argon and 7.8 liters of hydrogen per minute were used. The silicon tetrachloride-argon-hydrogen reaction mixture entered the shaped quartz tube and flowed over the heated molybdenum model. The flow up to the model and the reaction products were essentially colorless although slight discoloration of the reaction tube was observed downstream from the model during and after a coating run.

Coating Results

Three models were coated, with coating times of 10, 15, and 20 minutes. The coatings seemed hard and tightly bonded to the molybdenum since they could not be scraped off with a knife blade. When magnified at 200 diameters they appeared bright grey-silver, fine grained, and continuous. Considerable build-up of the coating on the edge of the model was observed. The coatings were identified as MoSi_2 by X-ray diffraction.

The weights and thicknesses of the models were measured before and after coating. The results of these measurements are shown plotted against coating time in figure 2.

CONCLUDING REMARKS

A laboratory-scale vapor-deposition coating facility (utilizing the hydrogen reduction process) has been constructed and put into operation to aid in research in the field of high-temperature coatings.

A molybdenum disilicide coating applied to molybdenum in the previously described facility has been tested in a supersonic hot-air jet at jet stagnation temperatures of about $3,500^\circ$ to $4,000^\circ$ F. A coated model reached an equilibrium temperature of about $3,100^\circ$ F and was undamaged after 470 seconds at this equilibrium temperature in the jet, while an uncoated model was vitually destroyed in less than 6 seconds.

Langley Aeronautical Laboratory,
National Advisory Committee for Aeronautics,
Langley Field, Va., August 30, 1957.

~~CONFIDENTIAL~~

REFERENCES

1. Northcott, L.: Molybdenum. Academic Press, Inc. (New York), 1956.
2. Anon.: Fansteel Tungsten and Molybdenum. Fansteel Metallurgical Corp., c.1954.
3. Maxwell, W. A.: Properties of Certain Intermetallics as Related to Elevated-Temperature Applications. I - Molybdenum Disilicide. NACA RM E9G01, 1949.
4. Long, Roger A.: Fabrication and Properties of Hot-Pressed Molybdenum Disilicide. NACA RM E50F22, 1950.
5. Maxwell, W. A.: Oxidation-Resistance Mechanism and Other Properties of Molybdenum Disilicide. NACA RM E52A04, 1952.
6. Maxwell, W. A.: Some Factors Affecting Fabrication and High-Temperature Strength of Molybdenum Disilicide. NACA RM E52B06, 1952.
7. Long, Roger A., and Freche, John C.: Preliminary Investigation of the Heat-Shock Resistant Properties of Molybdenum Disilicide Blades Under Centrifugal Load. NACA RM E52A17, 1952.
8. Maxwell, W. A.: Some Stress-Rupture and Creep Properties of Molybdenum Disilicide in the Range 1600° to 2000° F. NACA RM E52D09, 1952.
9. Powell, C. F., Campbell, I. E., and Gonser, B. W.: Vapor-Plating. John Wiley & Sons, Inc., 1955.
10. Purser, Paul E., and Hopko, Russell N.: Exploratory Materials and Missile-Nose-Shape Tests in a 4,000° F Supersonic Air Jet. NACA RM L56J09, 1956.
11. Hopko, Russell N., and Trout, Otto F., Jr.: Exploratory Tests of the Behavior of Several Materials in a Supersonic Air Jet at 4,000° F. NACA RM L57E24, 1957.
12. Anon.: Refractory Molybdenum Silicides. Chem. Data Ser. Bull. Cdb-6, Climax Molybdenum Co., Jan. 1956.

~~CONFIDENTIAL~~

TABLE I

WEIGHTS AND THICKNESSES OF MODELS BEFORE TESTING

(a) Uncoated

Model	W, oz	t, in.
1	0.0565	0.0295
2	.0565	.0295
3	.0565	.0295
4	.0565	.0295

(b) Coated

Model	Coating time, min	W, before coating, oz	ΔW , oz	t, before coating, in.	Δt , in. (a)
25	15	0.0568	0.00212	0.0295	0.0032
26	20	.0565	.00282	.0295	.0035
27	10	.0565	.00176	.0295	.0020

^aTotal for both sides:

W model weight, oz
 t model thickness, in.
 ΔW increase in weight, oz
 Δt increase in thickness, in.

~~CONFIDENTIAL~~

TABLE II

TEST RESULTS FOR COATED MODELS

Model	Run	Duration of run, sec	Cumulative test time, sec	Cumulative time at steady-state model temp., sec*	Remarks
27	1	90.0	90.0	78	No apparent damage
27	2	90.6	180.6	157	No apparent damage
27	3	89.6	270.2	234	No apparent damage
27	4	15.0	285.2	234	Started burning at 7 seconds of run 4
25	1	91.0	91.0	79	No apparent damage
25	2	91.0	182.0	158	No apparent damage
25	3	89.6	271.6	236	No apparent damage
25	4	89.9	361.5	314	No apparent damage
25	5	91.0	452.5	392	No apparent damage
25	6	88.9	541.4	469	No apparent damage
25	7	90.8	632.2	548	First damage occurred sometime during run 7

*Estimate based on the temperature time history of model 27 shown in figure 4.



(a) Photograph of typical uncoated model before mounting on holder.

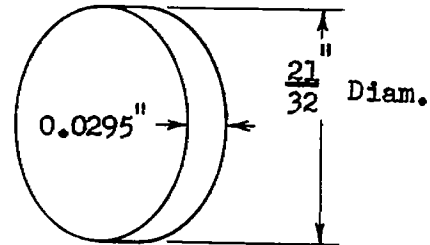

(b) Sketch of typical model, showing dimensions in inches.

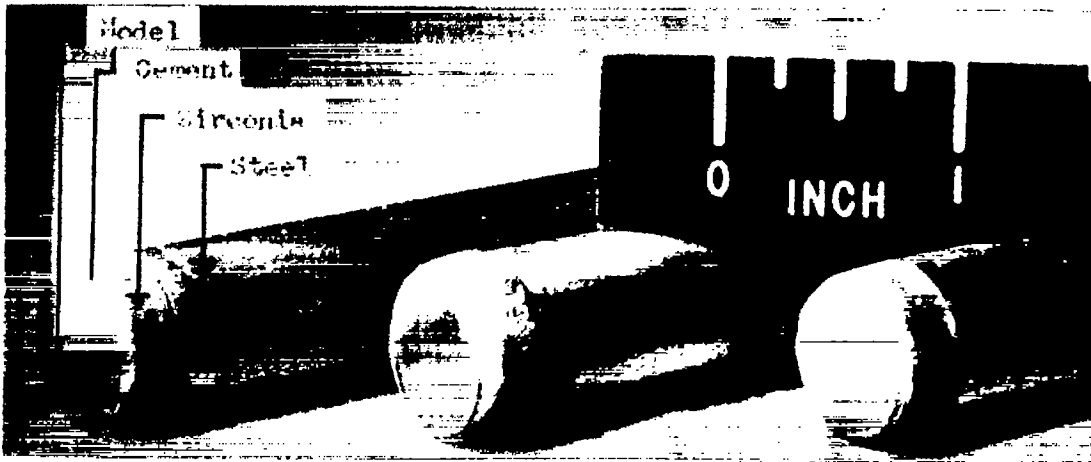

Model 25
(15 minute coating)

Model 27
(10 minute coating)

Model 26
(20 minute coating)

(c) Photograph showing coated models mounted on holders for testing.
Uncoated models were mounted in same manner.

Figure 1.- Photographs and sketch of typical models before testing. L-57-2751

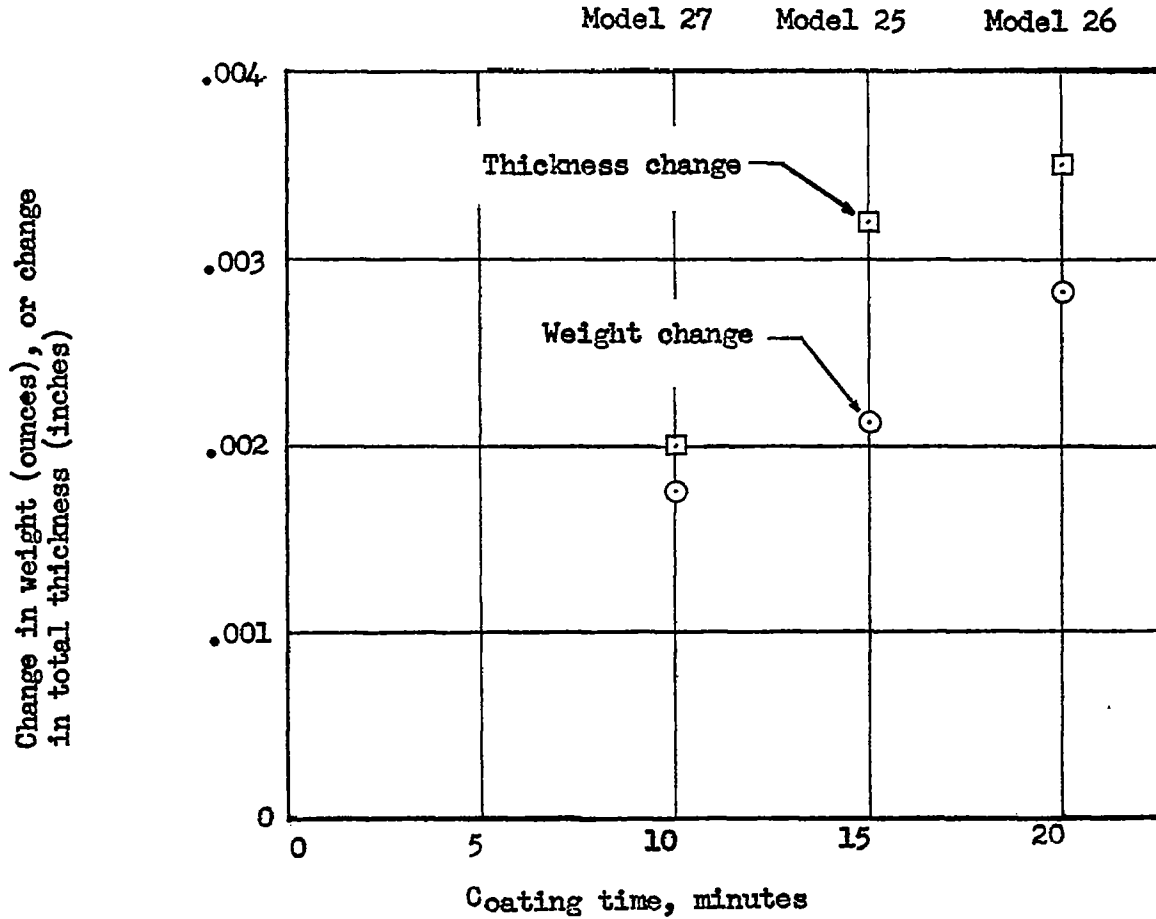
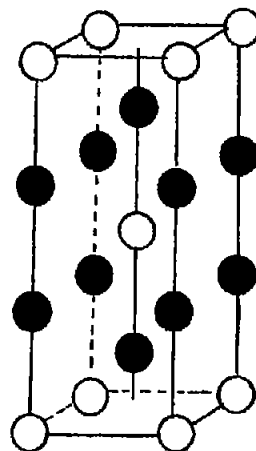
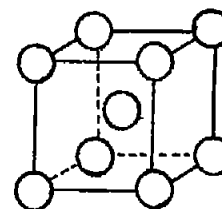

Figure 2.- Change in weight and thickness plotted against coating time.

MoSi₂ has a body-centered tetragonal structure. It consists of interpenetrating hexagonal nets of silicon atoms, with each silicon atom being a part of two such nets at right angles to each other. These nets divide the space into polyhedra, square prisms with pyramidal ends, the faces of each polyhedron being four squares and eight triangles. A molybdenum atom lies at the center of each polyhedron, surrounded by ten silicon atoms at 2.617 Å. Each silicon atom is bonded to five molybdenum and five silicon atoms, also at 2.617 Å. (ref. 12).



Body-centered tetragonal structure of MoSi₂



Body-centered cubic structure of Mo

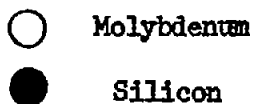

Figure 3.- Crystal structure of molybdenum disilicide (ref. 8).

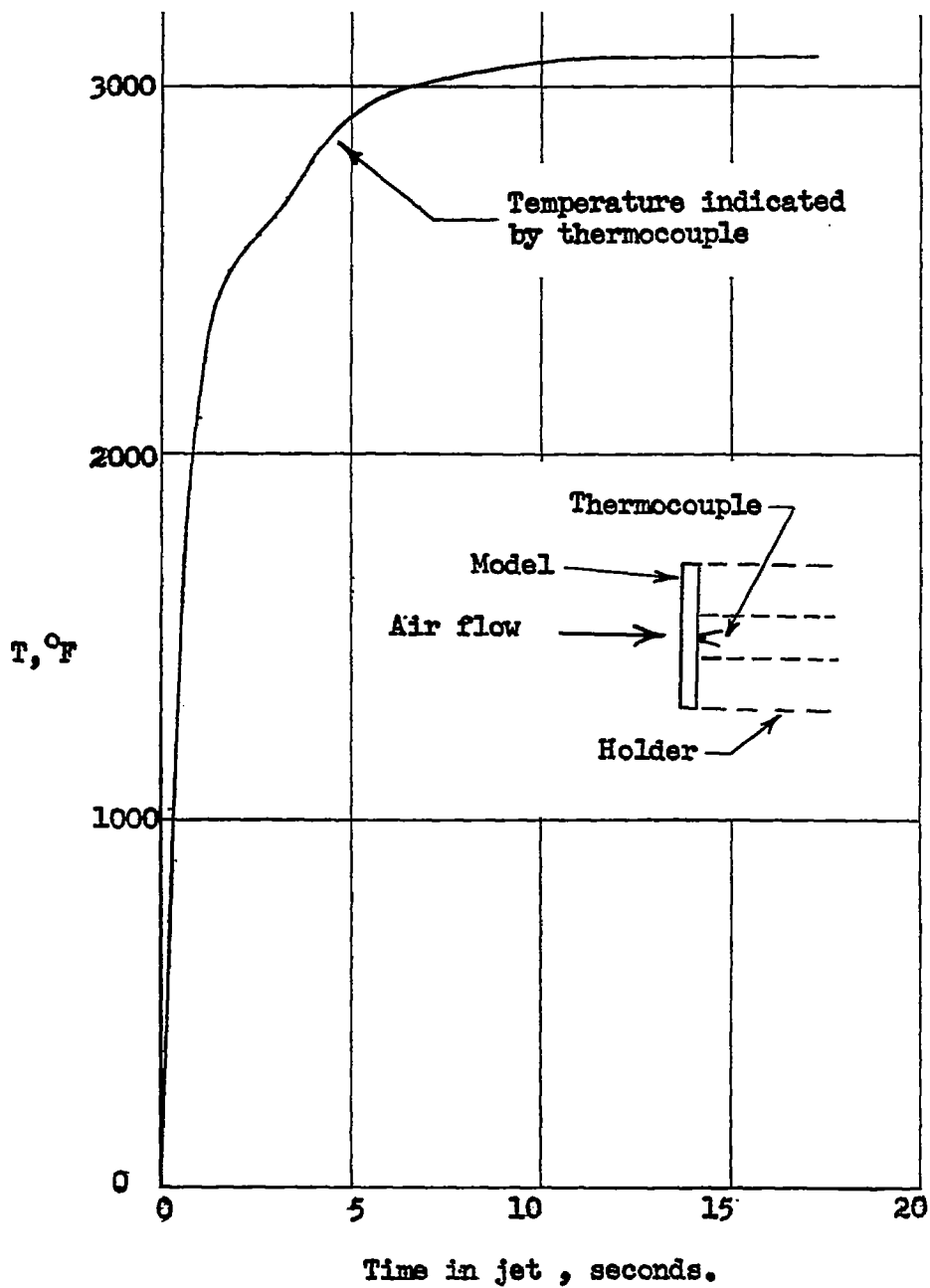

Figure 4.- Typical temperature time history of coated models.

Typical
uncoated
model
before
testing

Model 1
4070-3750 °F

Model 2
4080-3780 °F

Model 3
4080-3760 °F

Model 4
4080-3730 °F

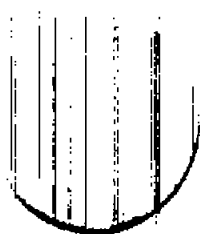

3.0 sec

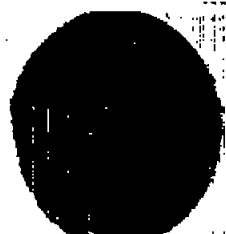

3.3 sec



4.7 sec



5.7 sec



(a) Uncoated models.

L-57-2312

Figure 5.- Test results for molybdenum models in ceramic-heated air jet. Temperatures shown are stagnation (bed) temperatures at beginning and end of run. Times shown are time in jet.

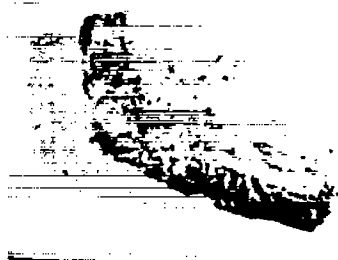

$\approx 4000-3300$ °F

- (b) Model 27 (10 minute coating)
after 285 seconds testing time.
Destruction began at 277 seconds.

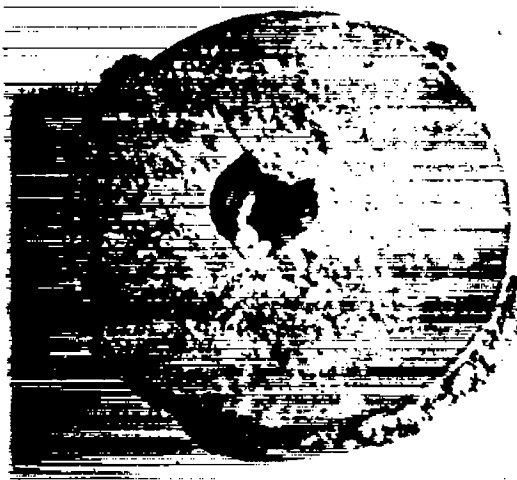

$\approx 4050-3400$ °F

- (c) Model 25 (15 minute coating)
after 632 seconds testing time.
Destruction began at some time
after 541 seconds.

Figure 5.- Concluded. L-57-2752

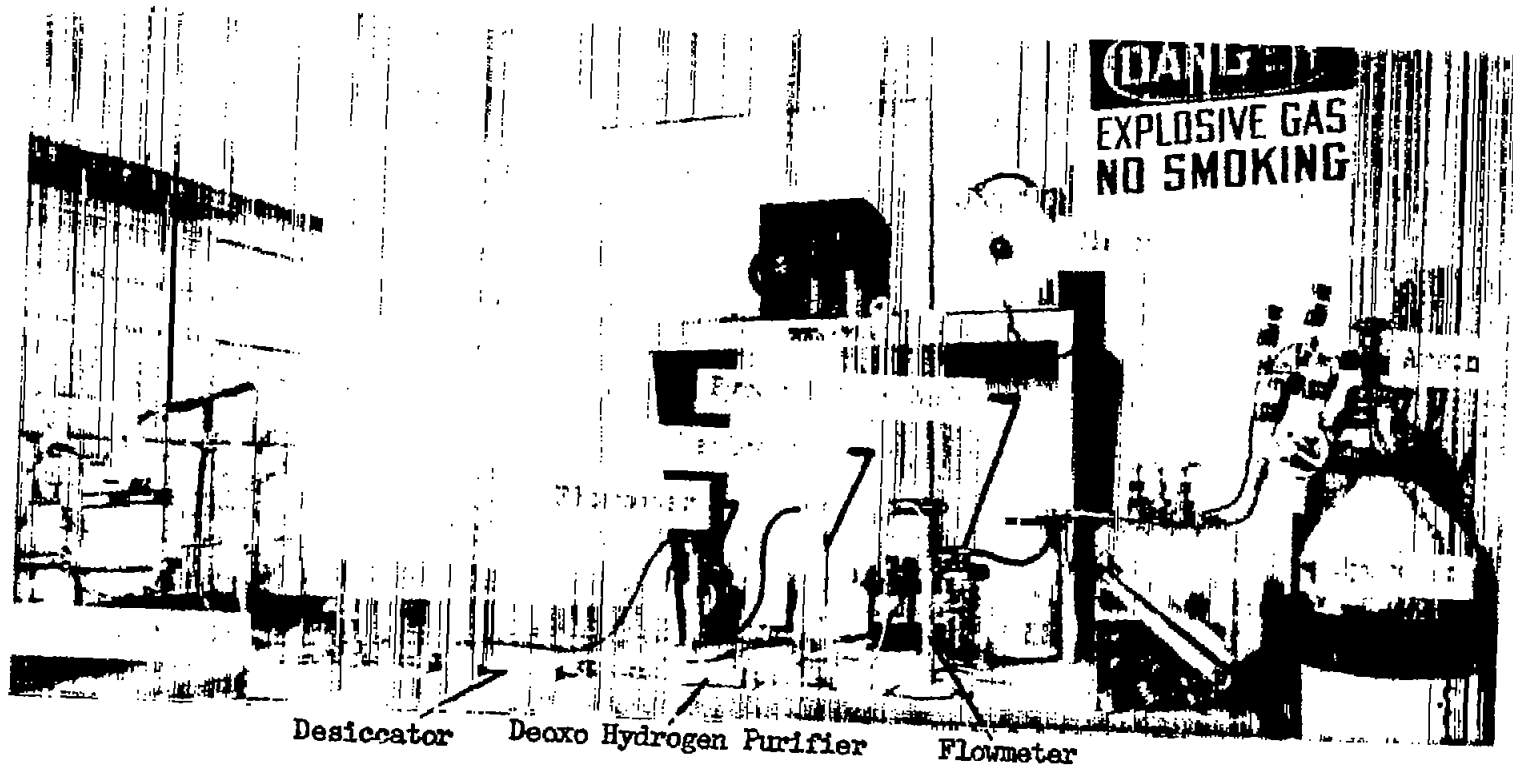

(a) Chemical purification and mixing. L-57-2272

Figure 6.- Laboratory-scale vapor-deposition apparatus.

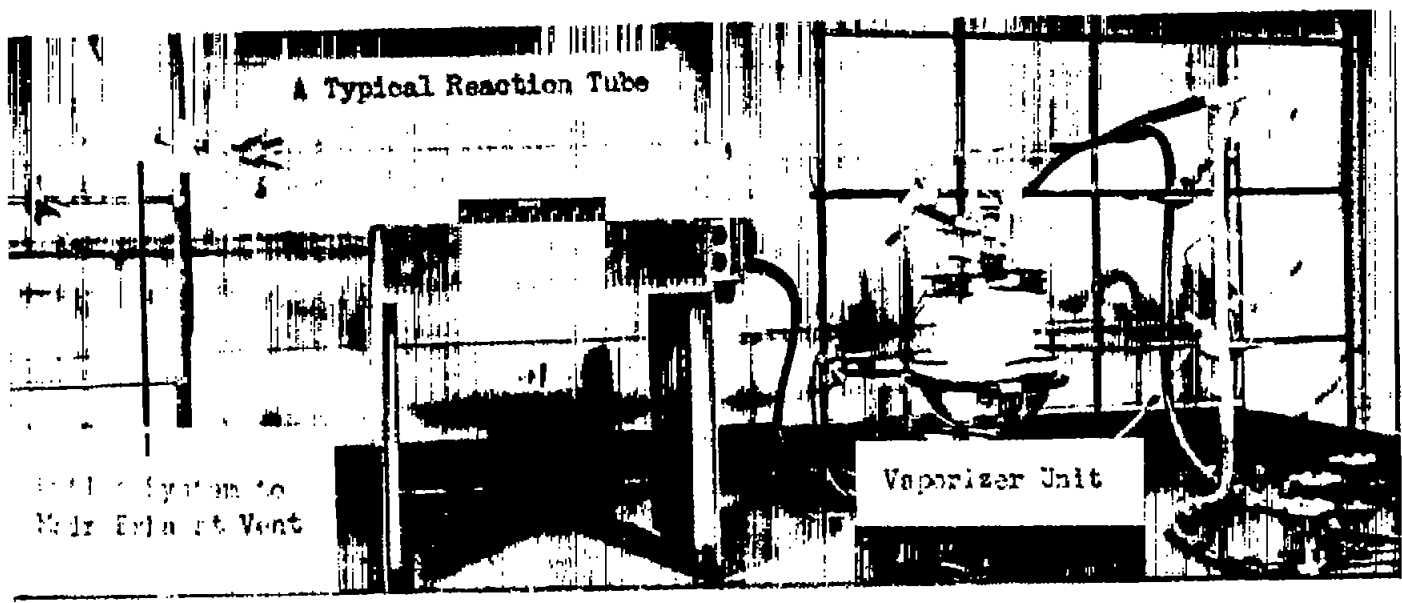

L-57-2753

(b) Reaction tube, without heating coil or model.

Figure 6.- Continued.

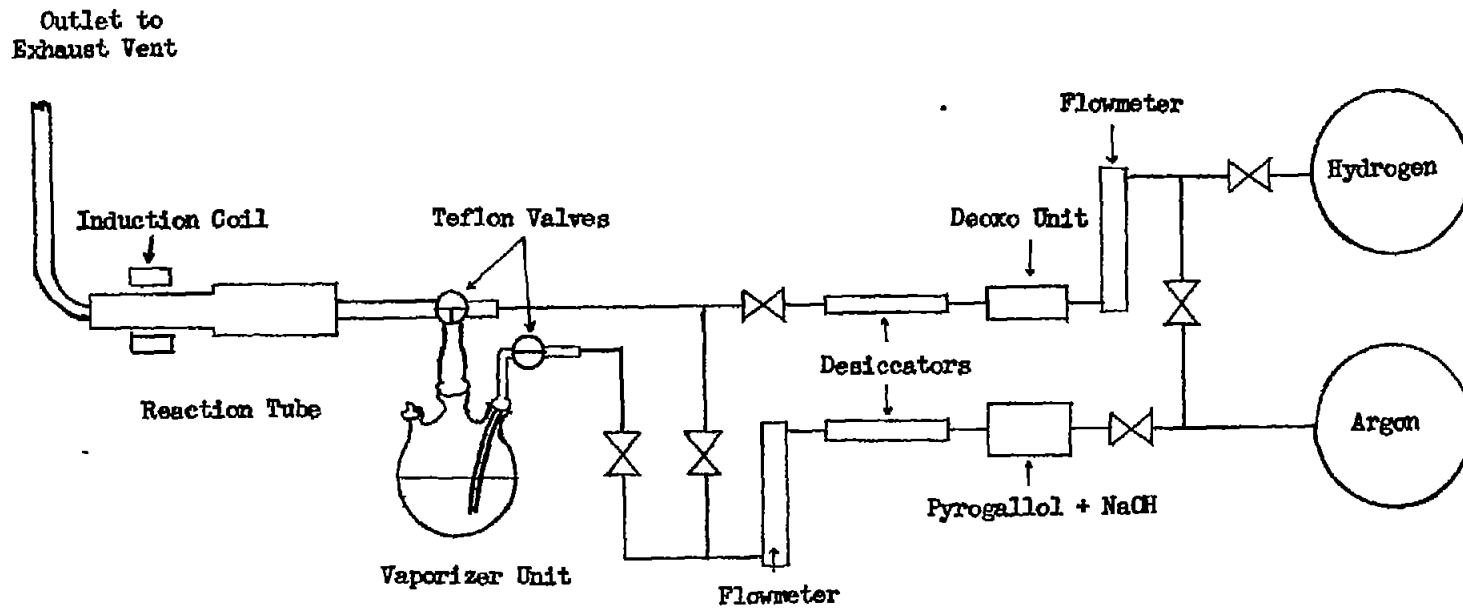

(c) Flow sheet of molybdenum disilicide coating system.

Figure 6.- Concluded.

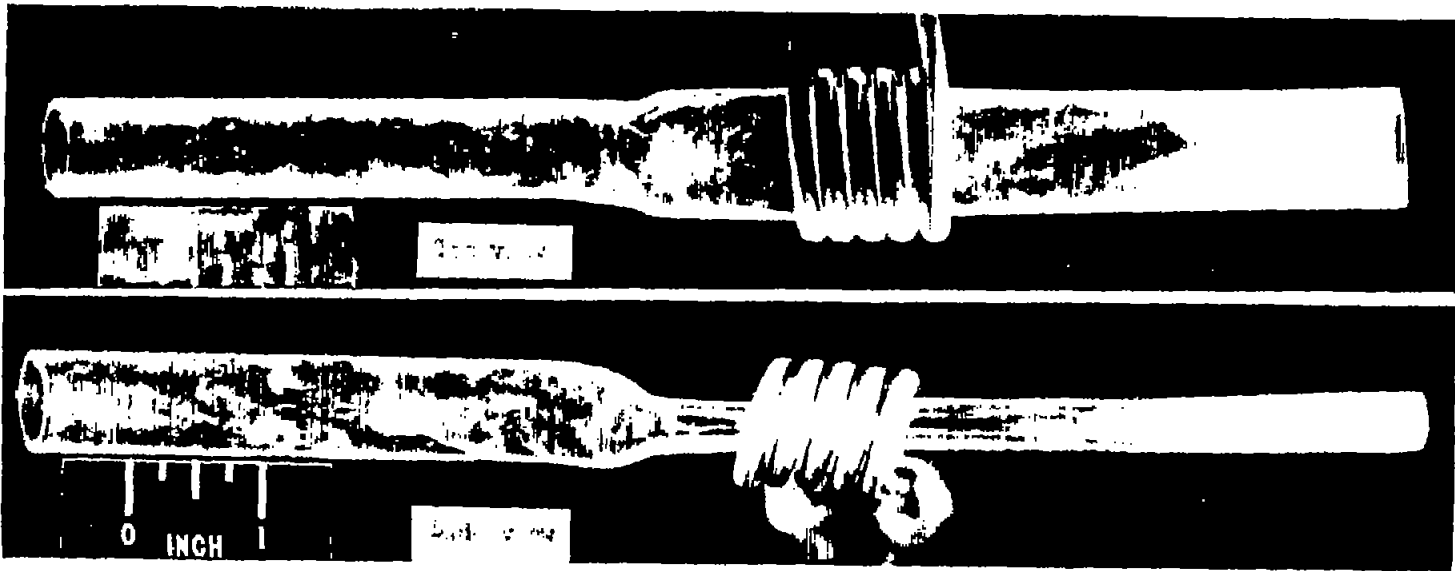

L-57-2754

Figure 7.- Quartz reaction tube and shaped induction coil (model not included).