

~~CONFIDENTIAL~~

Copy 191
RM L53G03

NACA RM L53G03

744

TECH LIBRARY KAFB, NM
0144392



RESEARCH MEMORANDUM

PRELIMINARY INVESTIGATION OF THE EFFECTS OF BODY
CONTOURING AS SPECIFIED BY THE TRANSONIC AREA RULE ON
THE AERODYNAMIC CHARACTERISTICS OF A DELTA WING-BODY
COMBINATION AT MACH NUMBERS OF 1.41 AND 2.01

By Harry W. Carlson

Langley Aeronautical Laboratory
Langley Field, Va.

CLASSIFIED DOCUMENT

This material contains information affecting the National Defense of the United States within the meaning of the espionage laws, Title 18, U.S.C., Secs. 793 and 794, the transmission or revelation of which in any manner to an unauthorized person is prohibited by law.

NATIONAL ADVISORY COMMITTEE FOR AERONAUTICS

WASHINGTON
September 22, 1953

~~CONFIDENTIAL~~



NATIONAL ADVISORY COMMITTEE FOR AERONAUTICS

RESEARCH MEMORANDUM

PRELIMINARY INVESTIGATION OF THE EFFECTS OF BODY
CONTOURING AS SPECIFIED BY THE TRANSONIC AREA RULE ON
THE AERODYNAMIC CHARACTERISTICS OF A DELTA WING-BODY
COMBINATION AT MACH NUMBERS OF 1.41 AND 2.01

By Harry W. Carlson

SUMMARY

An investigation has been performed in the Langley 4- by 4-foot supersonic pressure tunnel to determine the effects of body contouring (indentation) as specified by the transonic drag-rise area rule on the aerodynamic characteristics of a delta wing-body combination at Mach numbers of 1.41 and 2.01.

Body contouring reduced the zero-lift drag of a delta wing-body combination from that of the basic wing-body combination without contouring by 18 percent at a Mach number of 1.41 and 6 percent at a Mach number of 2.01. However, the amount of this drag reduction due to contouring and the amount due to the change in fineness ratio cannot be determined. The maximum lift-drag ratio was increased from 6.30 to 6.95 at a Mach number of 1.41. Little effect was noticed on the slope of the lift curve, the pitching moment, or the drag due to lift. In the practical applications of contouring, the drag advantages must be weighed against volume and frontal-area changes.

INTRODUCTION

Considerable work has been done and is being done to establish the validity of the transonic drag-rise area rule (see refs. 1, 2, and 3). For wing-body combinations it has been shown that, by proper reduction of body area in the vicinity of the wing, the transonic drag rise can be reduced as much as 60 percent and the drag-rise Mach number can be increased as much as 0.05. Sufficient data have heretofore not been available to determine whether the drag reduction realized at transonic speeds would persist to any extent at higher speeds. This preliminary

investigation has been conducted to determine whether any of this effect is apparent at Mach numbers 1.41 and 2.01.

For the purposes of this test, a delta wing-body combination was designed to have the same total area at any station as a body of revolution presented in reference 4 as an optimum body of given length, maximum diameter, and base diameter. In this case, the area rule was applied to sections normal to the body axis. It is recognized that this transonic area rule as applied here might not be the optimum technique for supersonic speeds and that consideration should be given to application of the area rule to sections parallel to the Mach lines. However, the primary purpose of this investigation was to test transonic designs at supersonic speeds.

SYMBOLS

M	free-stream Mach number
C_L	lift coefficient, L/qS
C_D	drag coefficient, D/qS
C_{D0}	drag coefficient at zero lift
C_m	pitching-moment coefficient, $M'/qS\bar{c}$
L	lift
D	drag
L/D	lift-drag ratio
M'	pitching moment about 0.275 \bar{c} station
S	wing plan-form area to center line of model
\bar{c}	wing mean aerodynamic chord
q	free-stream dynamic pressure, $\rho V^2/2$
ρ	free-stream density
V	free-stream velocity
α	angle of attack

APPARATUS AND METHODS

Models and Installation

Dimensional details of the configurations tested are shown in figure 1, and photographs of typical models are shown as figure 2. Figure 3 shows the variation with model station of the total cross-sectional area for the various wing-body configurations. Dimensional data not shown in the figures are presented in table I.

The interceptor-type body configuration is representative of current design practice for delta-wing interceptors in the aircraft industry.

The wing had a modified delta plan form with 4-percent-thick NACA 65A004 airfoil sections parallel to the model plane of symmetry. The internal strain-gage balance and sting were attached directly to the wing. As can be seen in the photographs, the wing was used with fences in place; however, previous unpublished results on a similar interceptor-type configuration have shown that at supersonic speeds the fences have negligible effect on the aerodynamic characteristics.

Two additional bodies were designed to be used on the same wing. One body, designated the full body, was a body of revolution presented in reference 4 as an optimum body of given length, maximum diameter, and base diameter. A second alternate body, called the contoured body, was constructed according to the area rule so that the total cross-sectional area of the wing-body combination at any station was the same as that of the full body alone.

Fourth and fifth configurations were obtained by adding an afterbody extension to the full and contoured bodies to reduce their base area to approximately that of the interceptor-type body.

The interceptor-type body was used as a guide in designing the contoured body. The contoured body without the extension has the same length as the interceptor body and approximately the same volume. The contoured body with extension has the same fineness ratio and base diameter as the interceptor-type body.

Test Conditions and Accuracy

The tests were performed in the Langley 4- by 4-foot supersonic pressure tunnel with the flexible nozzle walls set for nominal Mach numbers of 1.41 and 2.01.

The nominal conditions for the test were:

Mach number	1.41	2.01
Reynolds number based on \bar{c}	4.8×10^6	3.9×10^6
Stagnation dewpoint, °F	< -25	< -25
Stagnation pressure, psi	14	14
Stagnation temperature, °F	100	100

From the static calibration and reproducibility of the data the measured parameters were estimated to be accurate within the following limits:

C_L	± 0.005
C_D	± 0.0005
C_m	± 0.002

Corrections for sting and model deflections due to aerodynamic loads have been applied and the angles are estimated to be accurate within $\pm 0.1^\circ$.

DISCUSSION OF RESULTS

It must be emphasized that comparisons of the drag levels of the interceptor-type configuration and the other configurations should be avoided because of the inconsistency of the body shape variables and the presence of the faired inlets on the interceptor-type body. However, it is felt that a cautious comparison of the characteristics other than drag will aid in ascertaining the secondary effects of contouring.

Characteristics at Zero Lift

The primary purpose of body contouring is to decrease the drag at zero lift. An indication of the effectiveness of this method can be gained from an inspection of table II. This table presents zero-lift total drag coefficients, base pressure-drag coefficients, and forebody drag coefficients obtained by subtracting base drag from total drag. Data are given at Mach numbers of 1.41 and 2.01 for the five wing-body combinations and for the full body alone. Unless stated otherwise, the use of the term drag coefficient will be understood to mean forebody drag coefficient; and use of the terms full body, contoured body, and so forth will be understood to refer to the corresponding wing-body combinations.

Table II(a) shows the drag coefficients based on wing area. At a Mach number of 1.41 the full-body drag coefficient was 0.0167 and that of the contoured body was 0.0137, representing a drag reduction of 18 per-

cent. However, contouring the full body produced a drag reduction of less than 6 percent at a Mach number of 2.01. When the bodies were fitted with extensions, the contoured body showed 12 percent less drag at a Mach number of 1.41 and 3 percent at the higher Mach number.

In view of the relatively small reductions in drag and the sizable reductions in frontal area and volume brought about by contouring, it is interesting to compare drag coefficients when based on frontal area and on volume. The coefficients in table II(b) are nondimensionalized with respect to the body frontal area. Here there is little difference between the full and contoured bodies at a Mach number of 1.41, but at a Mach number of 2.01 the full body shows 16 percent less drag than the contoured body. With coefficients based on volume to the $2/3$ power (table II(c)) the contoured body shows 7 percent less drag than the full body at $M = 1.41$ and 7 percent more drag at the higher Mach number.

In general, it appears that contouring or body indentation permits drag reductions through the transonic range and into the low supersonic Mach number range (less than 2) with the favorable effects decreasing with an increase in Mach number. In the practical applications of contouring the drag advantages must be weighed against volume and frontal-area changes. Furthermore, the amount of this drag reduction due to contouring and the amount due to the change in fineness ratio cannot be determined. The need for further research along these lines is apparent.

Characteristics for the Lifting Condition

In figure 4 lift coefficient, drag coefficient, and lift-drag ratio have been plotted against angle of attack for the five configurations and for two Mach numbers. Figure 5 presents pitching-moment coefficient plotted against angle of attack and in figure 6 drag due to lift has been plotted against lift coefficient squared.

Lift.- Differences in the lift-curve slope for the five configurations are slight at both Mach numbers. The slope of the lift curve for all configurations is approximately 0.043 at a Mach number of 1.41 and is 0.031 at a Mach number of 2.01.

Lift-drag ratio.- As shown in figure 4, at a Mach number of 1.41 the contoured body had a maximum lift-drag ratio of 6.95, the highest of any of the configurations tested. The full body had a maximum lift-drag ratio of 6.30 at this Mach number.

At the higher Mach number, the differences in the lift-drag ratios of the various configurations are less evident. However, it should be noted that the full body has improved relative to the contoured body.

Pitching moment.- Pitching-moment coefficient for the various bodies is shown plotted against angle of attack in figure 5. At a Mach number of 1.41 the contoured body, which has the greatest exposed wing area behind the quarter-chord station, showed the greatest negative value of $\partial C_m / \partial \alpha$ of 0.0104. The interceptor-type body showed the lowest value of 0.009. The addition of the extensions did not appreciably affect the pitching-moment coefficient.

Drag due to lift.- From figure 6 it is seen that the curves of drag due to lift plotted against lift coefficient squared are essentially linear. The full body, with and without an extension, shows slightly greater incremental drag than the others, because a higher angle of attack is necessary to produce a given lift coefficient, due primarily to the smaller exposed wing area.

CONCLUDING REMARKS

Body contouring as specified by the transonic area rule reduced the zero-lift drag of a delta wing-body combination from that of the basic wing-body combination without contouring by 18 percent at a Mach number of 1.41 and 6 percent at a Mach number of 2.01. However, the amount of this drag reduction due to contouring and the amount due to the change in fineness ratio cannot be determined. The maximum lift-drag ratio was increased from 6.30 to 6.95 at a Mach number of 1.41.

The contouring had little effect on the slope of the lift curve, the pitching moment, or the drag due to lift.

In general, it appears that contouring or body indentation using the transonic area rule permits drag reductions through the transonic range and into the low supersonic Mach number range (less than 2), with the favorable effects decreasing as the Mach number increases. In the practical application of contouring, drag advantages must be weighed against volume and frontal-area changes.

Langley Aeronautical Laboratory,
National Advisory Committee for Aeronautics,
Langley Field, Va., June 12, 1953.

~~CONFIDENTIAL~~

REFERENCES

1. Whitcomb, Richard T.: A Study of the Zero-Lift Drag-Rise Characteristics of Wing-Body Combinations Near the Speed of Sound. NACA RM L52H08, 1952.
2. Robinson, Harold L.: A Transonic Wind-Tunnel Investigation of the Effects of Body Indentation, As Specified by the Transonic Drag-Rise Rule, on the Aerodynamic Characteristics and Flow Phenomena on a 45° Sweptback-Wing—Body Combination. NACA RM L52L12, 1953.
3. Carmel, Melvin M.: Transonic Wind-Tunnel Investigation of the Effects of Aspect Ratio, Spanwise Variations in Section Thickness Ratio, and a Body Indentation on the Aerodynamic Characteristics of a 45° Sweptback Wing-Body Combination. NACA RM L52L26b, 1953.
4. Adams, Mac C.: Determination of Shapes of Boattail Bodies of Revolution for Minimum Wave Drag. NACA TN 2550, 1951.

~~CONFIDENTIAL~~

TABLE I
MODEL DIMENSIONAL DATA

Configuration	Length, in.	Body frontal area, sq in.	Base area, sq in.	Volume, cu in.	Wing area, sq in.	Body fineness ratio
Interceptor-type body	30.25	10.05	5.10	255	234	8.46
Full body	30.25	15.92	8.95	300	234	6.72
Contoured body	30.25	12.65	8.95	249	234	7.55
Full body plus extension	33.37	15.92	5.04	322	234	7.42
Contoured body plus extension	33.37	12.65	5.04	271	234	8.32

 NACA
~~CONFIDENTIAL~~

TABLE II
 DRAG COEFFICIENTS AT ZERO LIFT FOR THE SEVERAL
 WING-BODY COMBINATIONS TESTED

(a) Coefficients based on wing area

Configuration	M = 1.41			M = 2.01		
	Total C_D	C_D of base	C_D of forebody	Total C_D	C_D of base	C_D of forebody
Contoured body	0.0200	0.0063	0.0137	0.0189	0.0056	0.0133
Full body	.0217	.0050	.0167	.0190	.0049	.0141
Contoured body with extension	.0179	.0008	.0171	.0170	.0016	.0154
Full body with extension	.0197	.0003	.0194	.0173	.0014	.0159
Full body, no wing	.0116	.0038	.0078	.0105	.0041	.0064
Full body with extension, no wing	.0100	.0005	.0095	.0094	.0010	.0084
Interceptor-type body	.0208	.0016	.0192	.0194	.0022	.0172

NACA

CONFIDENTIAL

CONFIDENTIAL

TABLE II.- Continued
 DRAG COEFFICIENTS AT ZERO LIFT FOR THE SEVERAL
 WING-BODY COMBINATIONS TESTED

(b) Coefficients based on body frontal area

Configuration	M = 1.41			M = 2.01		
	Total C_D	C_D of base	C_D of forebody	Total C_D	C_D of base	C_D of forebody
Contoured body	0.370	0.117	0.253	0.350	0.104	0.246
Full body	.318	.073	.245	.279	.072	.207
Contoured body with extension	.331	.015	.316	.314	.030	.285
Full body with extension	.289	.004	.285	.254	.020	.234
Full body, no wing	.170	.056	.114	.156	.060	.094
Full body with extension, no wing	.146	.007	.139	.138	.015	.123
Interceptor-type body	.485	.037	.448	.452	.051	.401

NACA

TABLE II.- Concluded
 DRAG COEFFICIENTS AT ZERO LIFT FOR THE SEVERAL
 WING-BODY COMBINATIONS TESTED

(c) Coefficients based on (body volume)^{2/3}

Configuration	M = 1.41			M = 2.01		
	Total C_D	C_D of base	C_D of forebody	Total C_D	C_D of base	C_D of forebody
Contoured body	0.1183	0.0372	0.0811	0.1119	0.0331	0.0788
Full body	.1130	.0260	.0870	.0989	.0255	.0734
Contoured body with extension	.0990	.0044	.0946	.0942	.0089	.0853
Full body with extension	.0974	.0015	.0959	.0855	.0069	.0786
Full body, no wing	.0604	.0198	.0406	.0546	.0213	.0333
Full body with extension, no wing	.0495	.0025	.0470	.0464	.0049	.0415
Interceptor-type body	.1208	.0093	.1115	.1128	.0128	.1000

NACA

CONFIDENTIAL

CONFIDENTIAL

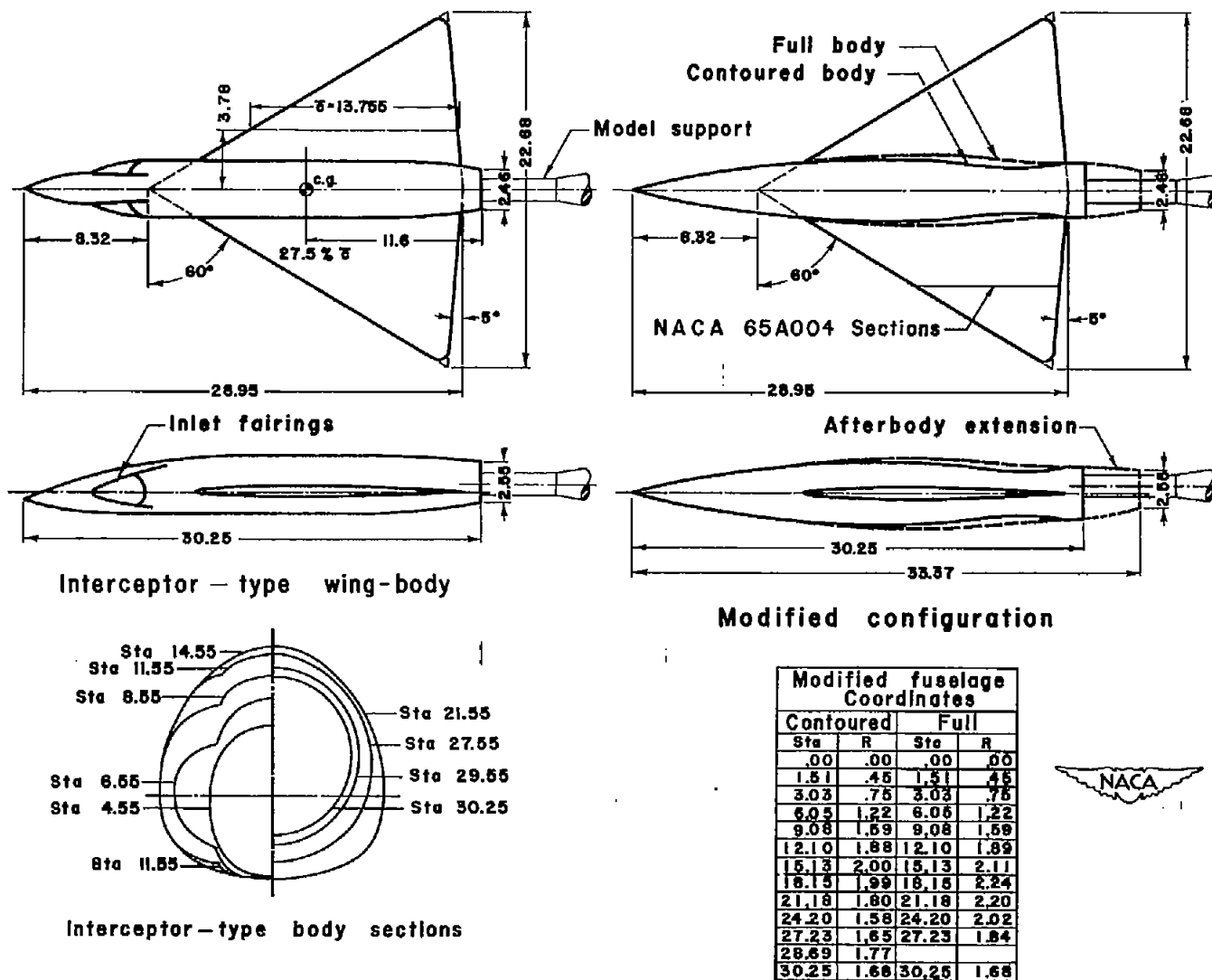
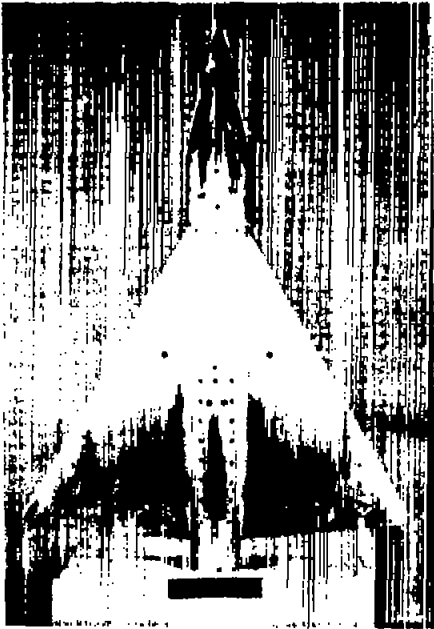
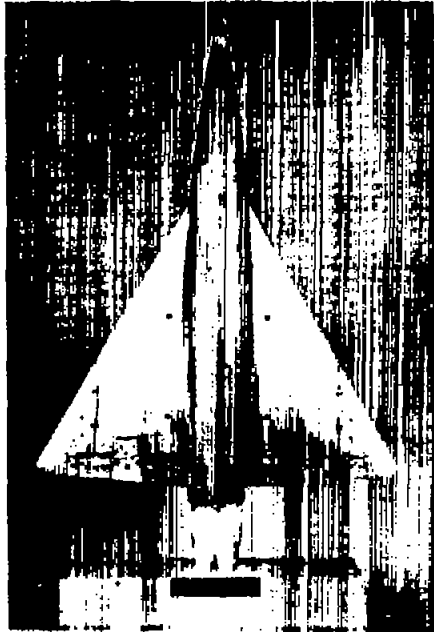

Figure 1.- Test models. All dimensions are in inches unless otherwise noted.



(a) Interceptor-type body.



(b) Full body with extension.

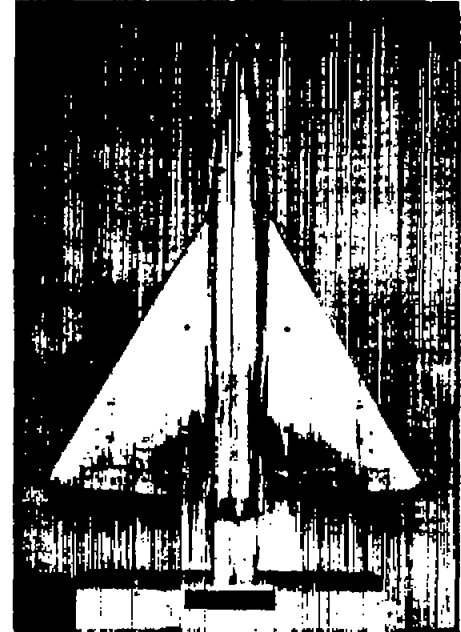

(c) Contoured body with extension.

L-80211

Figure 2.- Photographs of typical models.

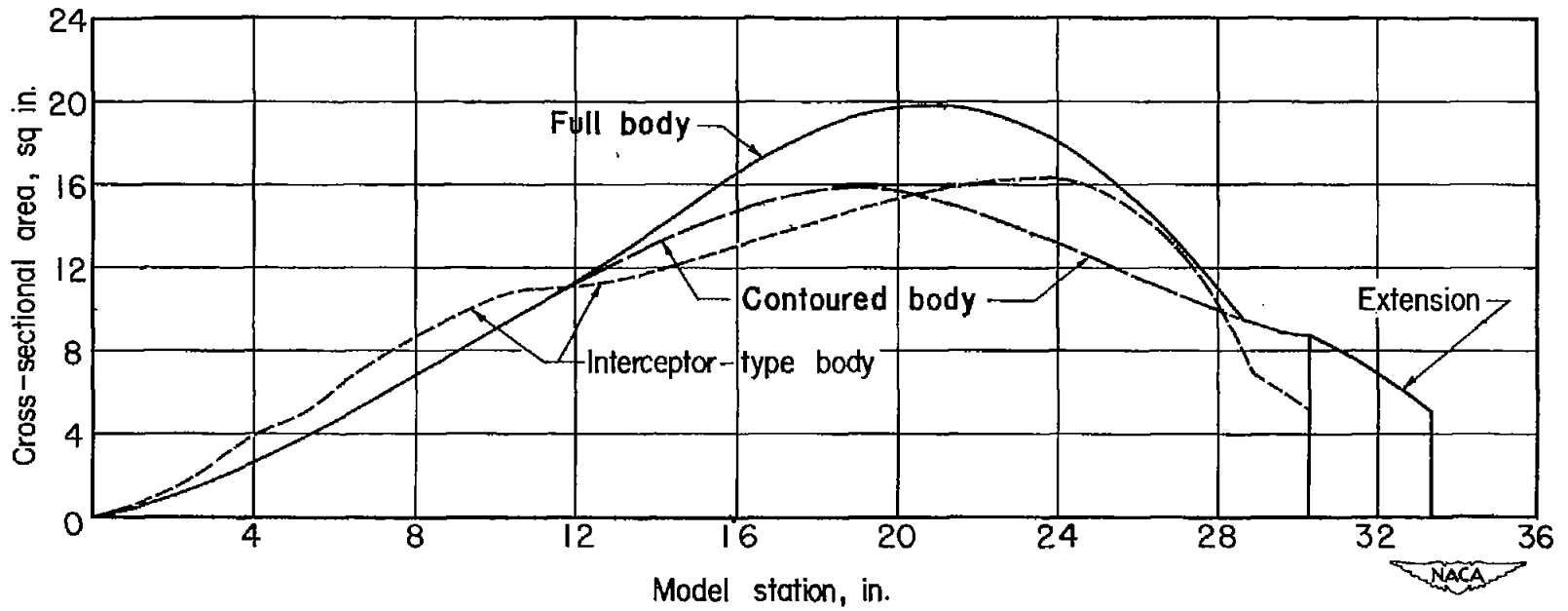
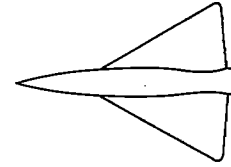
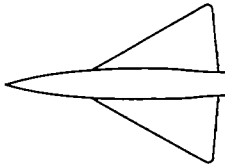
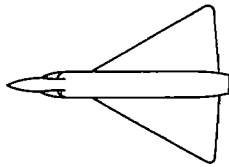

Figure 3.- Variation of total cross-sectional area with length for the several wing-body combinations.

Configurations



□ Interceptor-type body

○ Full body

△ Contoured body

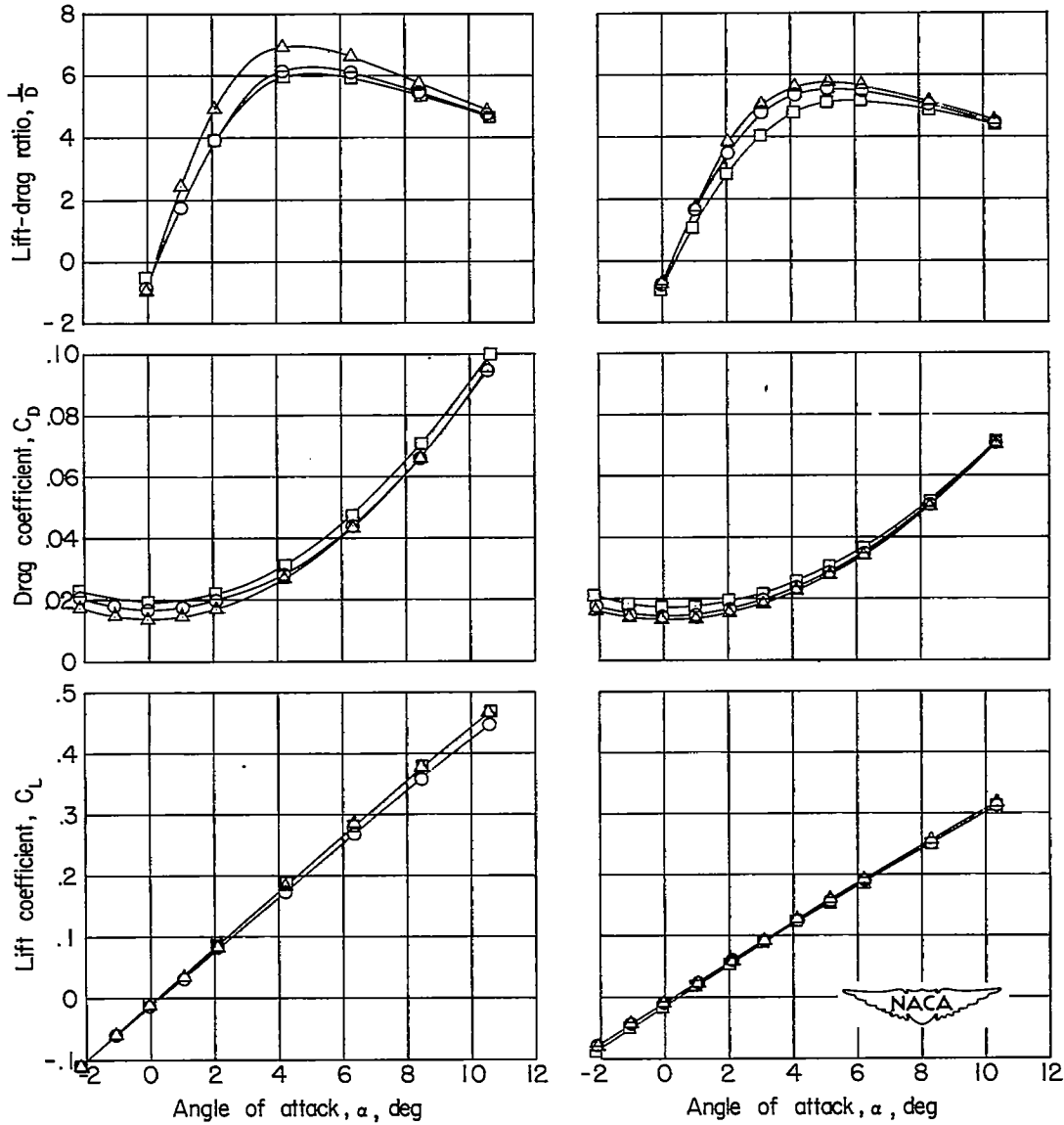

(a) $M = 1.41$.

(b) $M = 2.01$.

Figure 4.- Variation of lift coefficient, drag coefficient, and lift-drag ratio with angle of attack for the various wing-body combinations.

Configurations

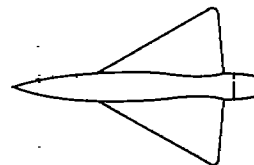
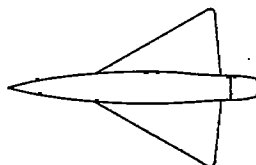
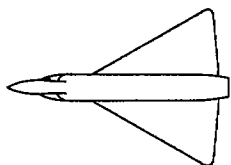

□ Interceptor-type body

□ Full body with extension

○ Contoured body with extension

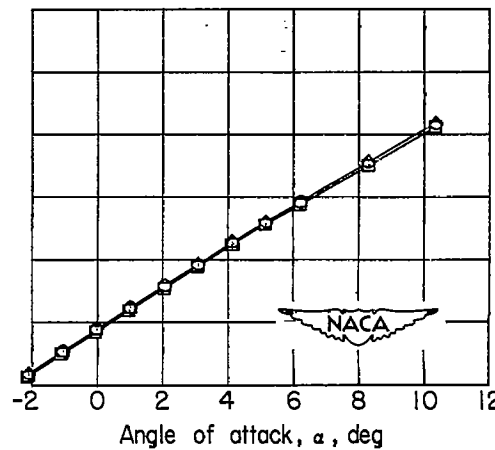
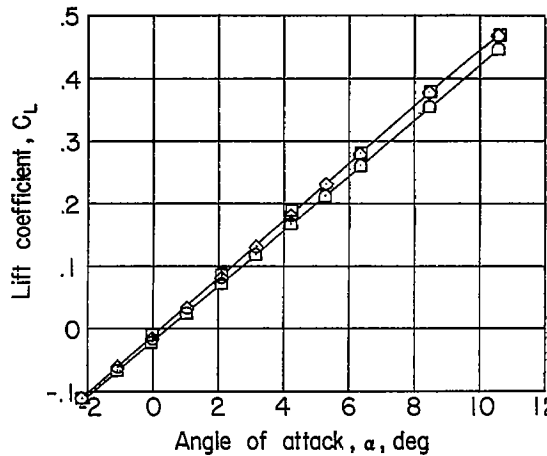
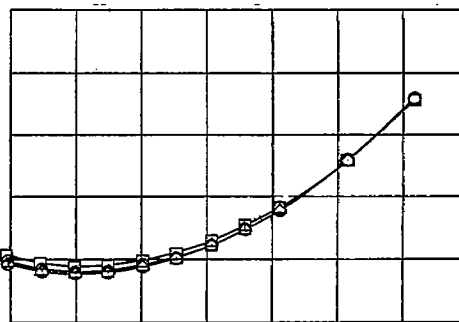
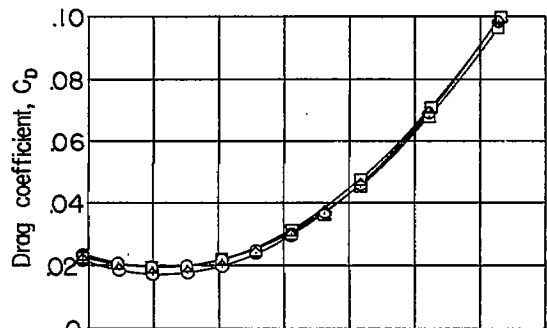
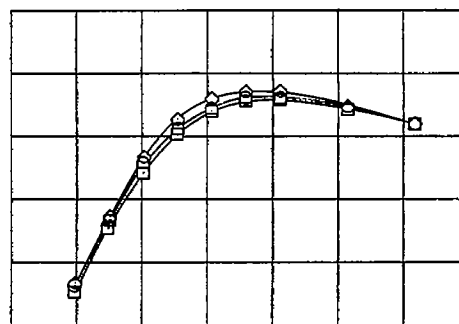
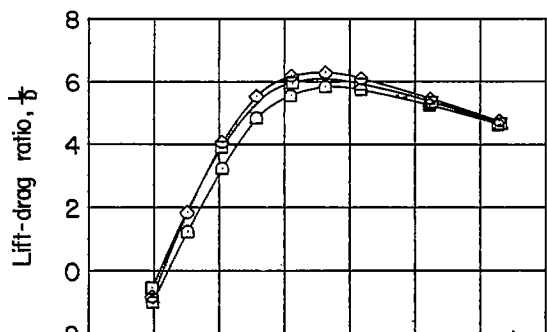

(a) Concluded.

(b) Concluded.

Figure 4.- Concluded.

Configurations

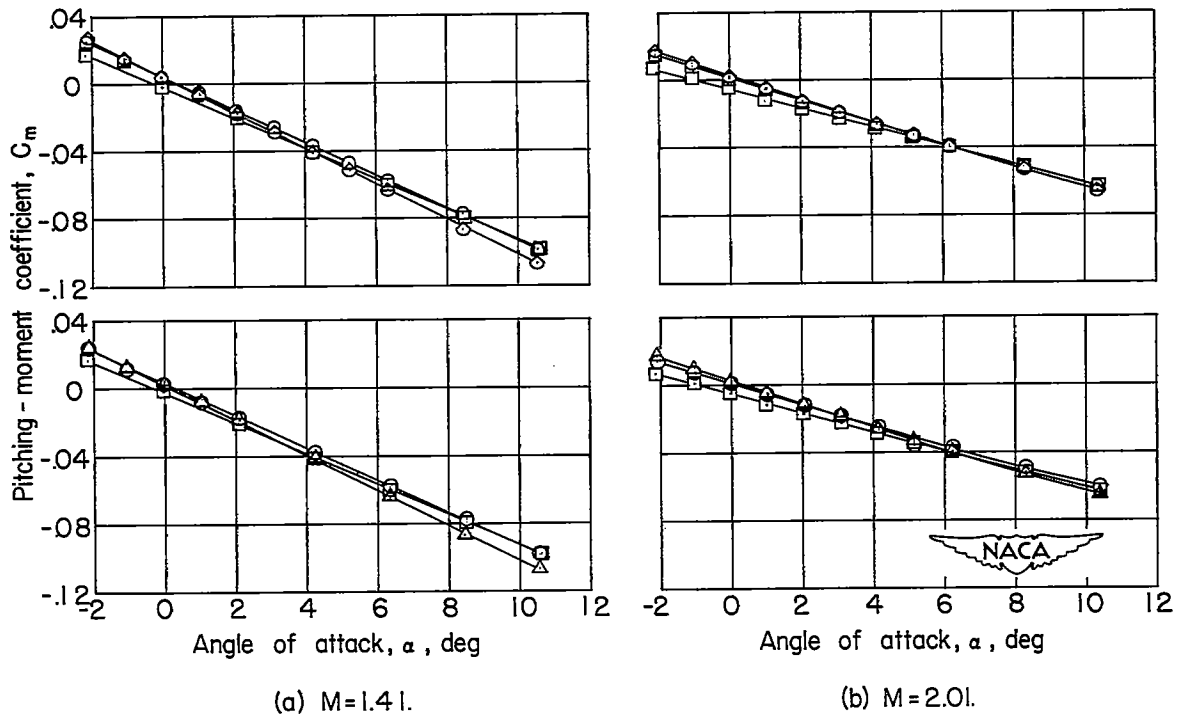
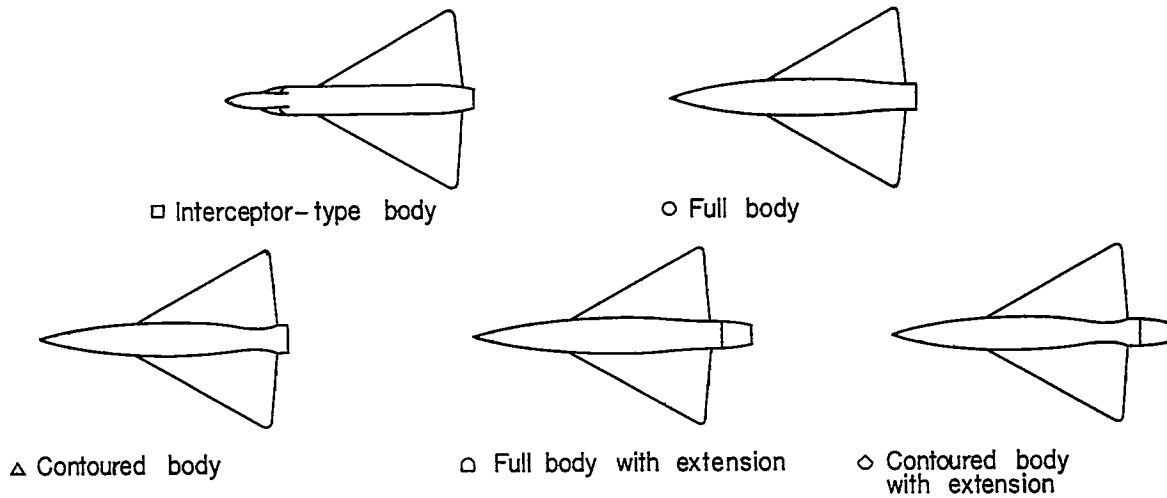
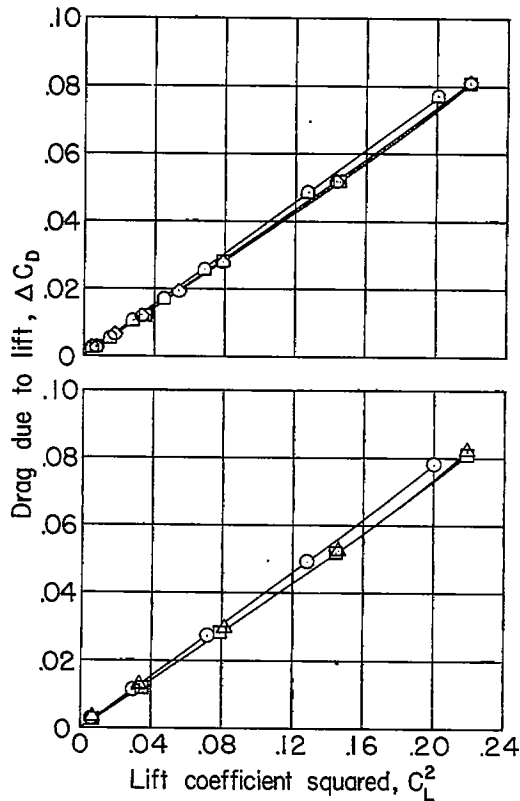
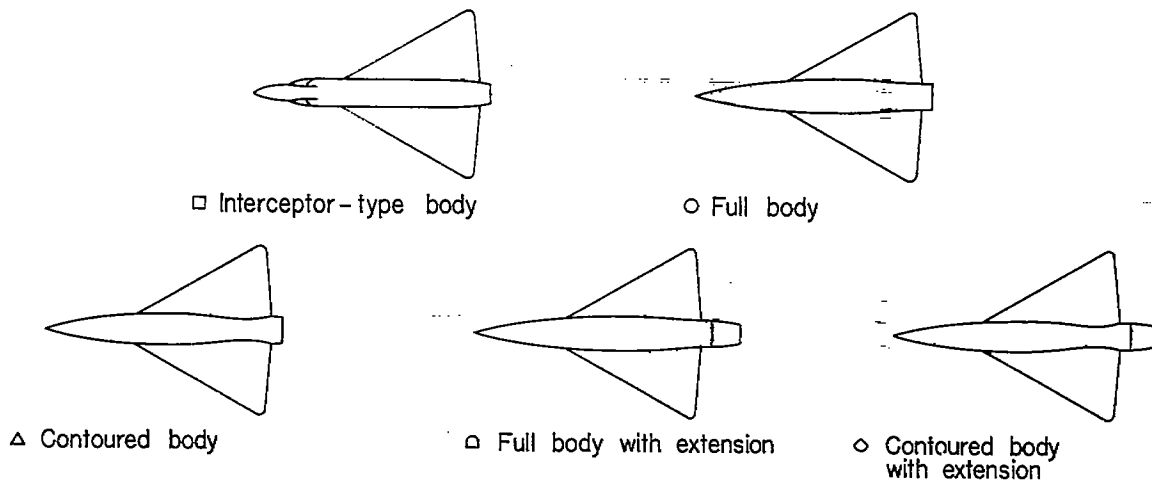
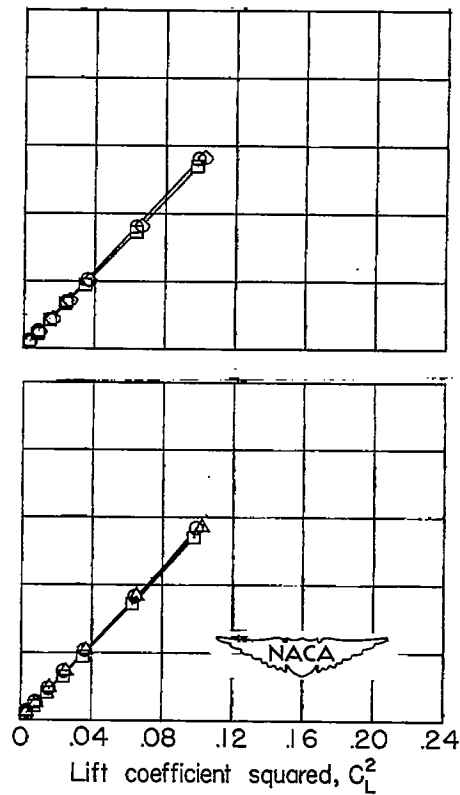

Figure 5.- Variation of pitching-moment coefficient with angle of attack for the various wing-body configurations.

Configurations



(a) M=1.41.



(b) M=2.01.

Figure 6.- Variation of drag due to lift with lift coefficient squared for the various wing-body configurations.