

NACA RM L53B03

7407

TECH LIBRARY KAFB, NM
0344394

NACA

RESEARCH MEMORANDUM

THE INFLUENCE OF A CHANGE IN BODY SHAPE ON THE EFFECTS
OF TWIST AND CAMBER AS DETERMINED BY A TRANSONIC
WIND-TUNNEL INVESTIGATION OF A 45° SWEEPBACK
WING-FUSELAGE CONFIGURATION

By Daniel E. Harrison

Langley Aeronautical Laboratory
Langley Field, Va.

NATIONAL ADVISORY COMMITTEE
FOR AERONAUTICS

WASHINGTON
August 14, 1953

CONFIDENTIAL



NATIONAL ADVISORY COMMITTEE FOR AERONAUTICS

RESEARCH MEMORANDUM

THE INFLUENCE OF A CHANGE IN BODY SHAPE ON THE EFFECTS
OF TWIST AND CAMBER AS DETERMINED BY A TRANSONIC
WIND-TUNNEL INVESTIGATION OF A 45° SWEEPBACK
WING-FUSELAGE CONFIGURATION

By Daniel E. Harrison

SUMMARY

An investigation has been made in the Langley 8-foot transonic tunnel to determine the influence of a change in body shape on the effects of twist and camber. The basic cylindrical fuselage was indented in the region of the wing on the basis of the transonic drag-rise rule. The wing had 45° sweepback at the 0.25-chord line, an aspect ratio of 4, a taper ratio of 0.6, and NACA 65A-series sections with 6-percent-thickness distribution parallel to the plane of symmetry. The twist and camber used was designed to obtain a uniform load distribution at a Mach number of 1.2 and a lift coefficient of 0.4.

Twist and camber greatly improved the maximum lift-drag ratios of the wing—modified-fuselage configuration throughout the speed range whereas twist and camber reduced the ratios for a wing—curved-fuselage configuration at Mach numbers between 0.84 and 0.99. The increases in the maximum lift-drag ratios of the wing—modified-fuselage configuration varied from 24 percent to 11 percent through the Mach number range. Up to a lift-coefficient value of 0.6 and a Mach number of 1.05, the increases in the lift-drag-ratio values due to twist and camber were considerably greater for the modified-fuselage than for the curved-fuselage configuration. For all test Mach numbers, the drag reductions caused by the use of twist and camber occurred at lower lift-coefficient values for the modified-fuselage than for the curved-fuselage configuration. The variations of the pitching-moment coefficients of the twisted and cambered wing-fuselage configuration with Mach number were greatly reduced by the use of the modified fuselage.

INTRODUCTION

The results of reference 1 indicated that the drag characteristics of a 45° sweptback wing-fuselage configuration could be improved at moderate and high lift coefficients by twisting and cambering the wing; however, at the lower lift coefficients and high subsonic Mach numbers, the twist and camber adversely affected the drag characteristics of the configuration as a result of increased wing-body interference. The results of reference 2 showed that the interference between a 45° sweptback wing and a fuselage could be greatly reduced by the use of a cylindrical afterbody and an extended forebody. The results of reference 3 also indicated that a favorable interference effect could be obtained at transonic speeds between a sweptback wing and a fuselage by indenting the fuselage in the region of the wing on the basis of the transonic drag-rise rule. It might be expected that the loss in effectiveness of twist and camber at high subsonic Mach numbers shown in reference 1 could be eliminated through the use of a cylindrical body indented on the basis of the area rule.

In order to determine the influence of such a change in body shape, the 45° twisted and cambered wing of reference 1 has been tested in combination with the modified fuselage of reference 4 in the Langley 8-foot transonic tunnel. The wing was twisted and cambered to obtain a uniform loading at a Mach number of 1.2 and a lift coefficient of 0.4. It should be noted that the relative high lift coefficient, 0.4, was chosen to improve the characteristics of the wing in the maneuver as well as in the cruise conditions of flight. The model was tested through a continuous Mach number range from 0.80 to 1.10 and at angles of attack from -3° to 12° . The results are compared herein with the results for the comparable plane wing-fuselage configuration of reference 4.

In addition to indentation, the fuselages compared in the present investigation differed in size and afterbody shape. It was realized that these differences would tend to distort the advantages or disadvantages of indentation; however, it was believed that any major differences in the two sets of data would be due primarily to indentation. The results of this investigation would then direct the path to future investigations of the transonic area-rule phenomenon.

SYMBOLS

b	wing span, in.
C_D	drag coefficient, D/qS
C_L	lift coefficient, L/qS

C_m	pitching-moment coefficient, $\frac{M_{\bar{c}}/4}{qS\bar{c}}$
c	local chord of wing, in.
\bar{c}	mean aerodynamic chord of wing, in.
D	drag, lb
L	lift, lb
$(L/D)_{\max}$	maximum lift-drag ratio
M	Mach number
$M_{\bar{c}}/4$	pitching moment of aerodynamic forces about lateral axis which passes through 0.25 point of mean aerodynamic chord of wing, in-lb
P_b	base pressure coefficient, $\frac{P_b - P_o}{q}$
P_o	free-stream static pressure, lb/sq ft
P_b	static pressure at model base, lb/sq ft
q	dynamic pressure, $\frac{1}{2}\rho V^2$, lb/sq ft
R	Reynolds number based on \bar{c}
S	wing area, sq ft
V	velocity, ft/sec
x	distance measured from leading edge of wing along local chord, in.
y	spanwise distance from plane of symmetry, in.
z	camber, in.
α	angle of attack of body center line, deg
ρ	air density, slugs/cu ft
e	angle of wing twist measured relative to fuselage reference line (fig. 1), deg

APPARATUS AND METHODS

The tests were conducted in the Langley 8-foot transonic tunnel which is a dodecagonal slotted-throat, single-return wind tunnel. The use of the longitudinal slots along the test section permitted the testing of the models through the speed of sound without the usual choking effects found in the conventional closed-throat tunnel. A complete description of the Langley 8-foot transonic tunnel can be found in reference 5.

Configurations

Except for twist and camber, the wing investigated was identical to the plane wing of reference 4. The plane wing as well as the twisted and cambered wing had 45° sweepback of the 0.25-chord line, an aspect ratio of 4, a taper ratio of 0.6, and NACA 65A-series airfoil sections with 6-percent-thickness distribution parallel to the plane of symmetry. A plan-form drawing of the wing-fuselage configuration is presented in figure 1.

The twisted and cambered wing investigated was designed to obtain a uniform load distribution at a lift coefficient of 0.4 and a Mach number of 1.2. The resulting twist and camber values are presented in figure 2. As shown in this figure, the angle of twist varied from 4.5° at the root to -0.2° (washout) at the tip. Twist was measured from the longitudinal axis of the fuselage.

The modified fuselage used in the present investigation (fig. 1) was basically cylindrical from the leading edge of the wing root section to behind the trailing edge. The fuselage was indented at the wing location such that the area removed from the body at each longitudinal station was equal to the exposed wing cross-sectional area at the same station normal to the airstream. The maximum diameter of the modified fuselage is somewhat greater than the curved fuselage of reference 1. Fuselage coordinates for both bodies are given in table I. The fineness ratio of the modified and the curved fuselages shown in figure 1 was 11.5 and 9.8, respectively.

Measurements and Accuracy

Lift, drag, and pitching moments were measured by an electrical strain-gage balance. The accuracy of the resulting coefficients is as follows:

C_L	± 0.010
C_D	± 0.001
C_m	± 0.004

The base pressure coefficients were determined by means of two static orifices located on the sides of the sting support in the plane of the model base. The drag data have been adjusted for base pressures such that the drag corresponds to conditions for which the body base pressure is equal to the free-stream static pressure. No corrections have been made to the base pressures for sting interference effects (ref. 6).

Local deviations from the average free-stream Mach numbers in the region of the model were no larger than 0.003 at subsonic speeds; with increases in Mach number above 1.00, the deviations increased but did not exceed 0.010 at a Mach number of 1.13.

The angle of attack was measured by an electrical strain gage mounted in the nose of the model. A complete description of the angle-of-attack measuring system is given in reference 7, and, as reported therein, the measurements are believed to be accurate to within ± 0.1 .

The effects of wall-reflected disturbance on the drag results have been essentially eliminated at all Mach numbers except those near a value of about 1.05. This effect has been accomplished by displacing the model from the tunnel center line and by correcting for the base-pressure variations. No results were obtained for Mach numbers near 1.05.

RESULTS

The basic aerodynamic data (angle of attack, drag coefficient, and pitching-moment coefficient against lift coefficient) are presented in figure 3 for the configuration with twisted and cambered wing and modified fuselage. Comparisons of the basic data for the various configurations are shown in figure 4. The base pressure coefficients for the twisted and cambered wing and the plane wing--modified-fuselage configurations are shown in figure 5. Variations of maximum lift-drag ratios with Mach number for the wing-fuselage configurations are presented in figure 6. The maximum lift-drag ratios presented as a function of Mach number for the wing in the presence of the fuselage are shown in figure 7. The effects of twist and camber and body modifications on the lift-drag ratios of the configurations are presented in figure 8 for several lift coefficients. Comparisons of the variation of pitching-moment coefficient with Mach number are shown in figure 9 for several lift coefficients.

In order to facilitate presentation of the data, staggered scales have been used in many of the figures and care should be taken in identifying the zero axis for each curve. All the data presented herein are for wing-fuselage configurations with the exception of the wing-body interference maximum lift-drag ratios shown in figure 7. Reynolds numbers based on the mean aerodynamic chord varied from about 1.90×10^6 to 2.00×10^6 .

DISCUSSION

The incidence of the plane wing relative to the center line of the fuselage was zero, whereas the incidence of the root sections of the twisted and cambered wing was 4.5° . This degree of incidence was in accordance with the prescribed method of reference 8 for calculating twist and camber. Because of this arrangement, the incidence of the fuselage at zero lift coefficient was approximately 3° less for the cambered and twisted wing configuration than for the plane wing configuration.

Lift Characteristics

The changes in the lift curves of the wing—modified-fuselage configuration (fig. 4) due to replacing the plane wing with the twisted and cambered wing were similar to those reported in reference 1 for the wing—curved-fuselage configuration. The results presented in this figure also indicated that the lift-coefficient values of the twisted and cambered wing-fuselage configuration were not appreciably changed by the use of the modified fuselage.

Drag Characteristics

Throughout the Mach number range, the drag reductions caused by the use of twist and camber occurred at lower lift-coefficient values for the modified-fuselage configuration than for the curved-fuselage configuration. At a Mach number of 1.00, twist and camber reduced the drag-coefficient values of the modified-fuselage configuration above a lift-coefficient value of 0.15 as compared to a lift-coefficient value of 0.29 for the curved-fuselage configuration. Although the modified fuselage was considerably larger than the curved fuselage, the drag values of the twisted and cambered wing-fuselage configuration at zero lift were reduced above a Mach number of 0.95 by the use of the modified fuselage. Generally, this reduction was also true for the higher lift-coefficient values; however, the drag reductions were not so large.

The maximum lift-drag ratios presented in figure 6 indicated that the twist and camber greatly improved the $(L/D)_{\max}$ values of the wing-modified-fuselage configuration throughout the Mach number range whereas twist and camber reduced the $(L/D)_{\max}$ values of the wing-curved-fuselage configuration between the Mach numbers of 0.84 and 0.99. It was suggested in reference 1 that the lower $(L/D)_{\max}$ values of the curved-fuselage configuration at high subsonic speeds could have been caused by increases in wing-fuselage interference associated with the twist and camber. The study of the flow over the plane wing-curved-fuselage combination (ref. 9) indicated that a strong shock is produced behind the trailing edge of the inboard sections of the wing which travels outwardly across the outboard sections of the wing. This shock was probably also present for the twisted and cambered wing and may have produced greater amounts of separation on the outboard region of the twisted and cambered wing than on the plane wing. The results of reference 4 showed that indentation applied to a cylindrical body essentially eliminated the shock behind the trailing edge of the plane wing. The indentation probably also greatly reduced the strength of this shock and its adverse effects on the boundary layer of the outboard region for the twisted and cambered wing configuration. Increases in $(L/D)_{\max}$ values, caused by twisting and cambering the wing of the modified configuration, resulted from these effects. These increases varied from 24 percent to 11 percent through the Mach number range.

The variations of the maximum lift-drag ratios with Mach number for the wing in the presence of the fuselage are shown in figure 7. A cylindrical fuselage (ref. 4) with the same dimensions as the modified fuselage, except at the wing location, was used to determine the wing-body interference of the wing-modified-fuselage configuration. The modified fuselage was not used because the higher drag values of the fuselage, as compared to the cylindrical fuselage, would have shown erroneous advantages of indentation. Twist and camber increased the values for the wing in presence of the modified fuselage throughout the Mach number range whereas the twist and camber reduced the wing-interference ratios of the curved-fuselage configuration up to a Mach number of 1.0.

Comparisons of the ratios of the lift-drag values for the twisted and cambered wing and the plane wing

$$\frac{(L/D)_{\text{Twisted and cambered wing}}}{(L/D)_{\text{Plane wing}}}$$

presented in figure 8 for several lift coefficients indicated that up through a lift coefficient of 0.6 and a Mach number of 1.05, the increases in L/D values due to twist and camber were much greater for the wing-modified-fuselage configuration than for the wing-curved-fuselage configuration. As the lift coefficient was increased beyond 0.2, the advantages of the modified fuselage became less apparent.

Pitching-Moment Characteristics

The changes in the pitching-moment coefficients of the modified fuselage configuration (fig. 4) caused by the use of twist and camber were similar to those reported in reference 1 for the curved-fuselage configuration. The modified fuselage, however, delayed the unstable break in the pitching-moment curves of the twisted and cambered wing-fuselage configuration to a higher lift coefficient value up to a Mach number of 0.95. This effect is important since an increase in the lift-coefficient values at which the unstable break in the pitching-moment curves occurs may improve the performance of the airplane in the climb or maneuver condition of flight.

The variations of pitching-moment coefficients with Mach number presented in figure 9 for several lift coefficients indicated that twist and camber negatively displaced the pitching-moment curves of the modified configurations as for the curved-fuselage combination. Twist and camber reduced the changes of the pitching-moment coefficient with Mach number for the modified-fuselage configuration throughout the Mach number range whereas the reverse was true for the curved-fuselage configuration up to a lift-coefficient value of 0.6. It can be seen, also, that variations of the pitching-moment coefficient with Mach number for the twisted and cambered wing were greatly reduced by the use of the modified fuselage.

CONCLUSIONS

The results of a transonic wind-tunnel investigation to determine the influence of a body modification on the effects of twist and camber of a 45° sweptback wing-fuselage configuration at Mach numbers from 0.80 to 1.10 indicate the following conclusions:

1. Twist and camber greatly improved the maximum lift-drag ratios of the wing—modified-fuselage configuration throughout the speed range whereas twist and camber reduced the ratios for a wing—curved-fuselage configuration at high subsonic speeds. The increases in the maximum lift-drag ratios of the wing—modified-fuselage configuration varied from 24 percent to 11 percent through the Mach number range. Up to a lift coefficient of 0.6 and a Mach number of 1.05, the increases in the lift-drag-ratio values due to twist and camber were considerably greater for the modified-fuselage than for the curved-fuselage configuration.

2. Throughout the Mach number range, the drag reductions due to the use of twist and camber occurred at lower lift-coefficient values for the modified-fuselage configuration than for the curved-fuselage configuration.

3. The variations of the pitching-moment coefficients of the twisted and cambered wing-fuselage configuration with Mach number were greatly reduced by the use of the modified fuselage.

Langley Aeronautical Laboratory,
National Advisory Committee for Aeronautics,
Langley Field, Va., January 29, 1953.

REFERENCES

1. Harrison, Daniel E.: A Transonic Wind-Tunnel Investigation of the Characteristics of a Twisted and Cambered 45° Sweptback Wing-Fuselage Configuration. NACA RM L52K18, 1952.
2. Loving, Donald L., and Wornom, Dewey E.: Transonic Wind-Tunnel Investigation of the Interference Between a 45° Sweptback Wing and a Systematic Series of Four Bodies. NACA RM L52J01, 1952.
3. Whitcomb, Richard T.: A Study of the Zero-Lift Drag-Rise Characteristics of Wing-Body Combinations Near the Speed of Sound. NACA RM L52H08, 1952.
4. Robinson, Harold L.: A Transonic Wind-Tunnel Investigation of the Effects of Body Indentation, as Specified by the Transonic Drag-Rise Rule, on the Aerodynamic Characteristics and Flow Phenomena of a 45° Sweptback-Wing-Body Combination. NACA RM L52L12, 1953.
5. Wright, Ray H., and Ritchie, Virgil S.: Characteristics of a Transonic Test Section With Various Slot Shapes in the Langley 8-Foot High-Speed Tunnel. NACA RM L51H10, 1951.
6. Osborne, Robert S., and Mugler, John P., Jr.: Aerodynamic Characteristics of a 45° Sweptback Wing-Fuselage Combination and the Fuselage Alone Obtained in the Langley 8-Foot Transonic Tunnel. NACA RM L52E14, 1952.
7. Williams, Claude V.: A Transonic Wind-Tunnel Investigation of the Effects of Body Indentation, as Specified by the Transonic Drag-Rise Rule, on the Aerodynamic Characteristics and Flow Phenomena of an Unswept-Wing-Body Combination. NACA RM L52L23, 1953.
8. Jones, Robert T.: Estimated Lift-Drag Ratios at Supersonic Speeds. NACA TN 1350, 1947.
9. Whitcomb, Richard T., and Kelly, Thomas C.: A Study of the Flow Over a 45° Sweptback Wing-Fuselage Combination at Transonic Mach Numbers. NACA RM L52D01, 1952.

TABLE I.- COORDINATES OF MODIFIED AND CURVED FUSELAGES

Modified fuselage		Curved fuselage	
Station, in.	Radius, in.	Station, in.	Radius, in.
0	0	0	0
.225	.104	.200	.092
.338	.134	.300	.119
.563	.193	.500	.171
1.125	.325	1.000	.289
2.250	.542	2.000	.482
3.375	.762	3.000	.645
4.500	.887	4.000	.788
6.750	1.167	6.000	1.037
9.000	1.391	8.000	1.236
11.250	1.559	10.000	1.386
13.500	1.683	12.000	1.496
15.750	1.770	14.000	1.573
18.000	1.828	16.000	1.625
20.250	1.864	18.000	1.657
22.500	1.875	20.000	1.667
23.125	1.875	22.000	1.652
24.125	1.842	24.000	1.610
25.125	1.787	26.000	1.537
26.125	1.710	28.000	1.425
27.125	1.641	30.000	1.251
28.125	1.592	32.000	1.010
29.125	1.560	34.000	.741
30.125	1.572		
31.125	1.611		
32.125	1.640		
33.125	1.656		
34.125	1.688		
35.125	1.740		
36.125	1.802		
37.125	1.850		
38.125	1.874		
38.375	1.875		
43.000	1.875		

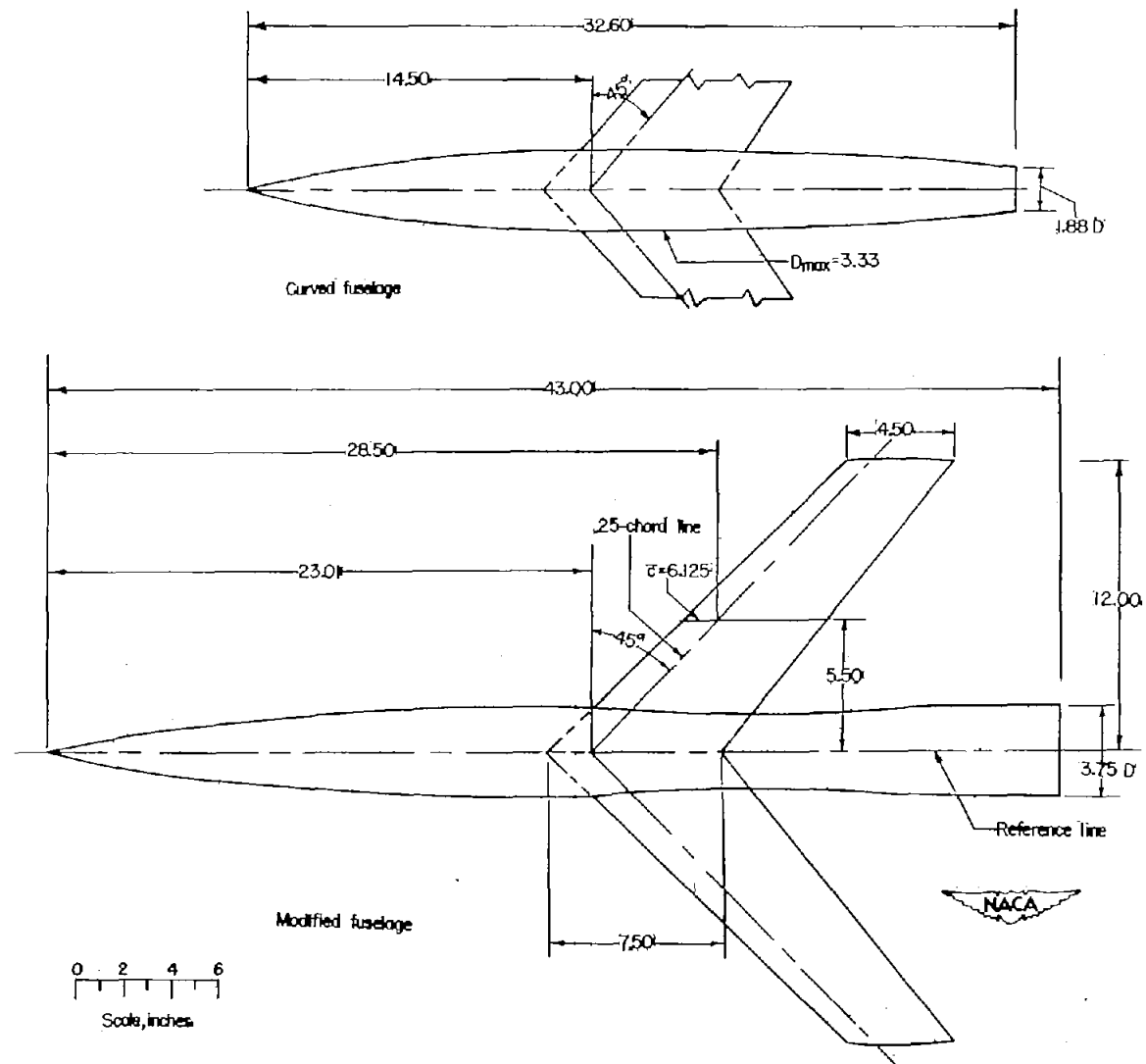

Figure 1.- Wing-fuselage configurations. All dimensions are in inches.

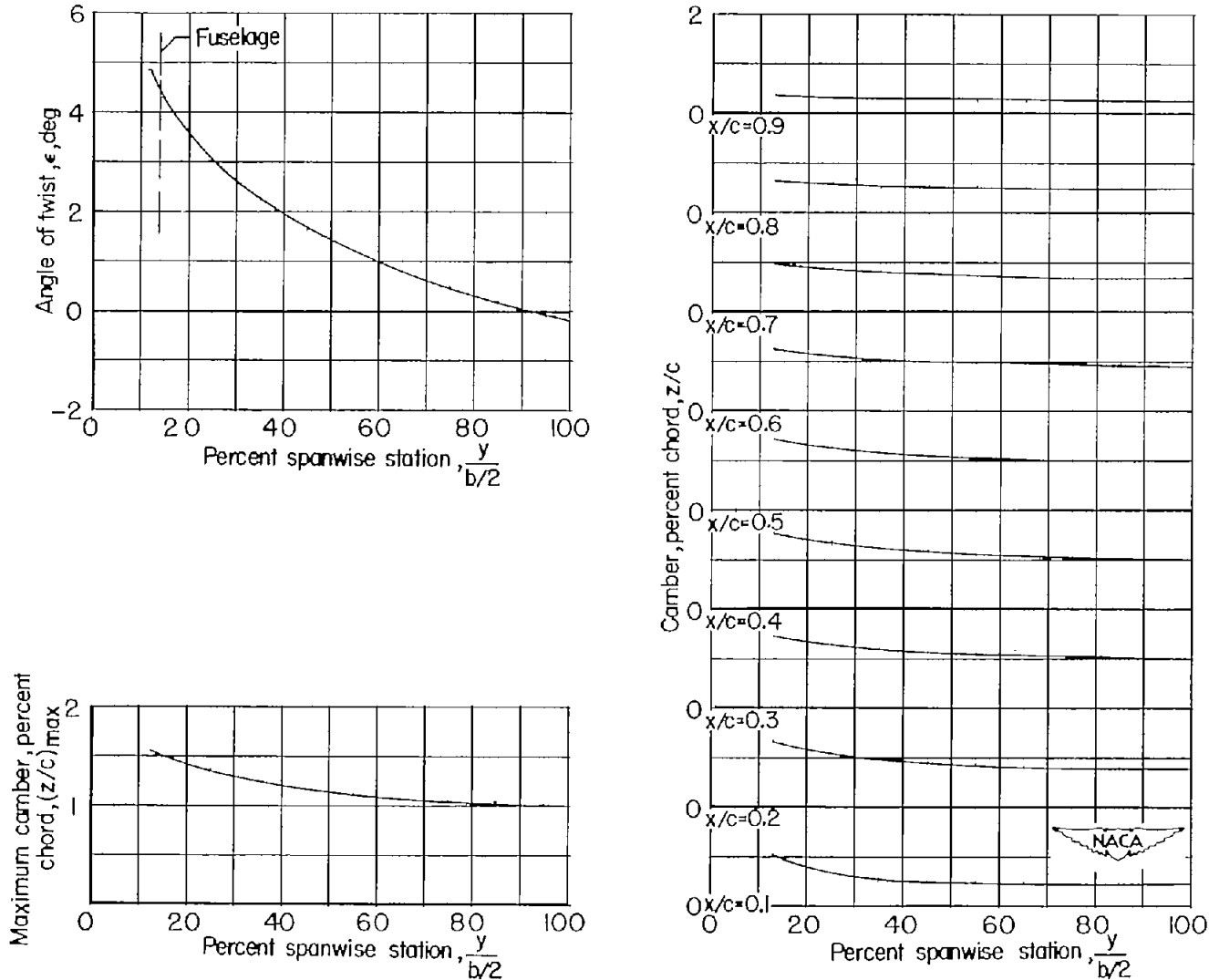
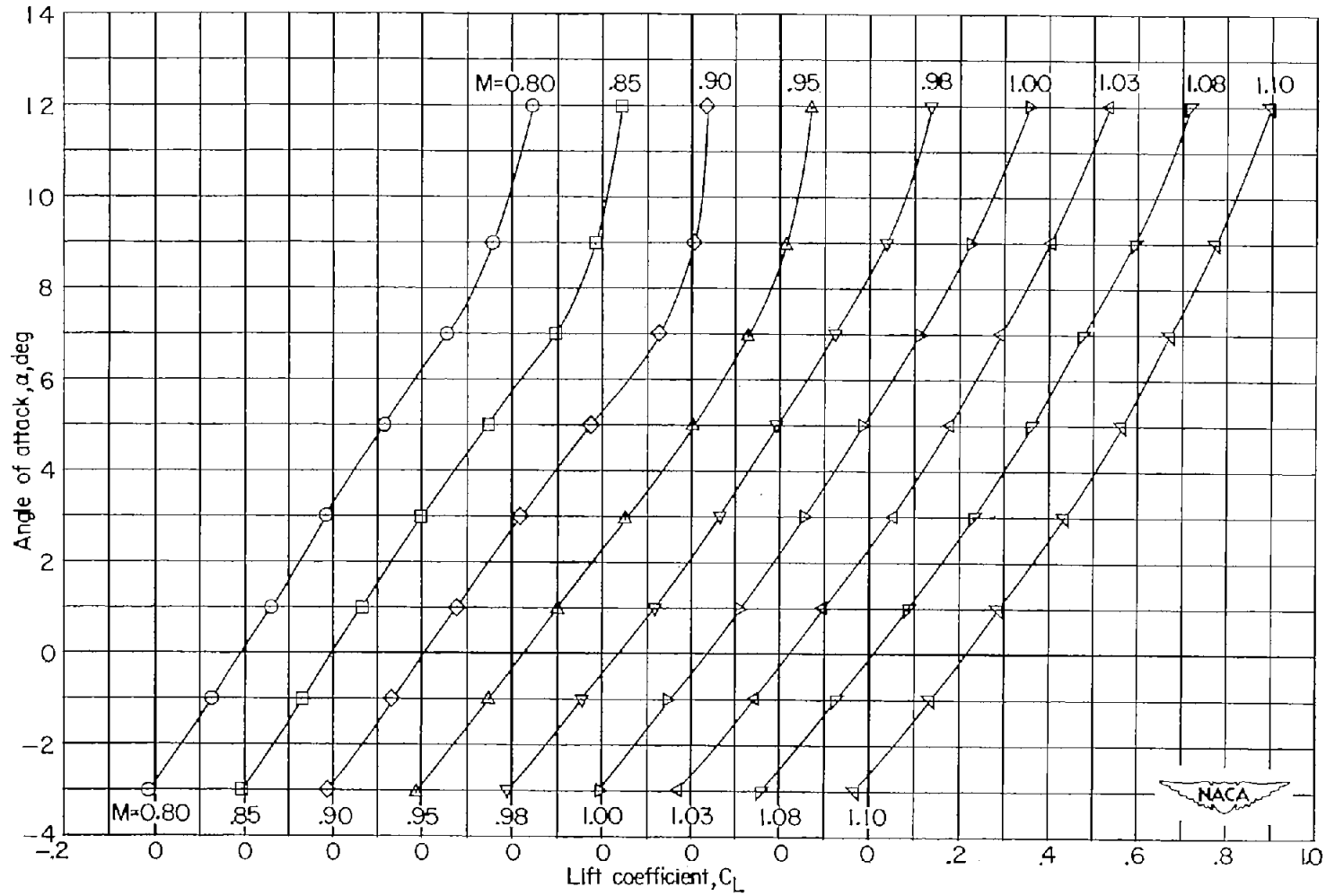
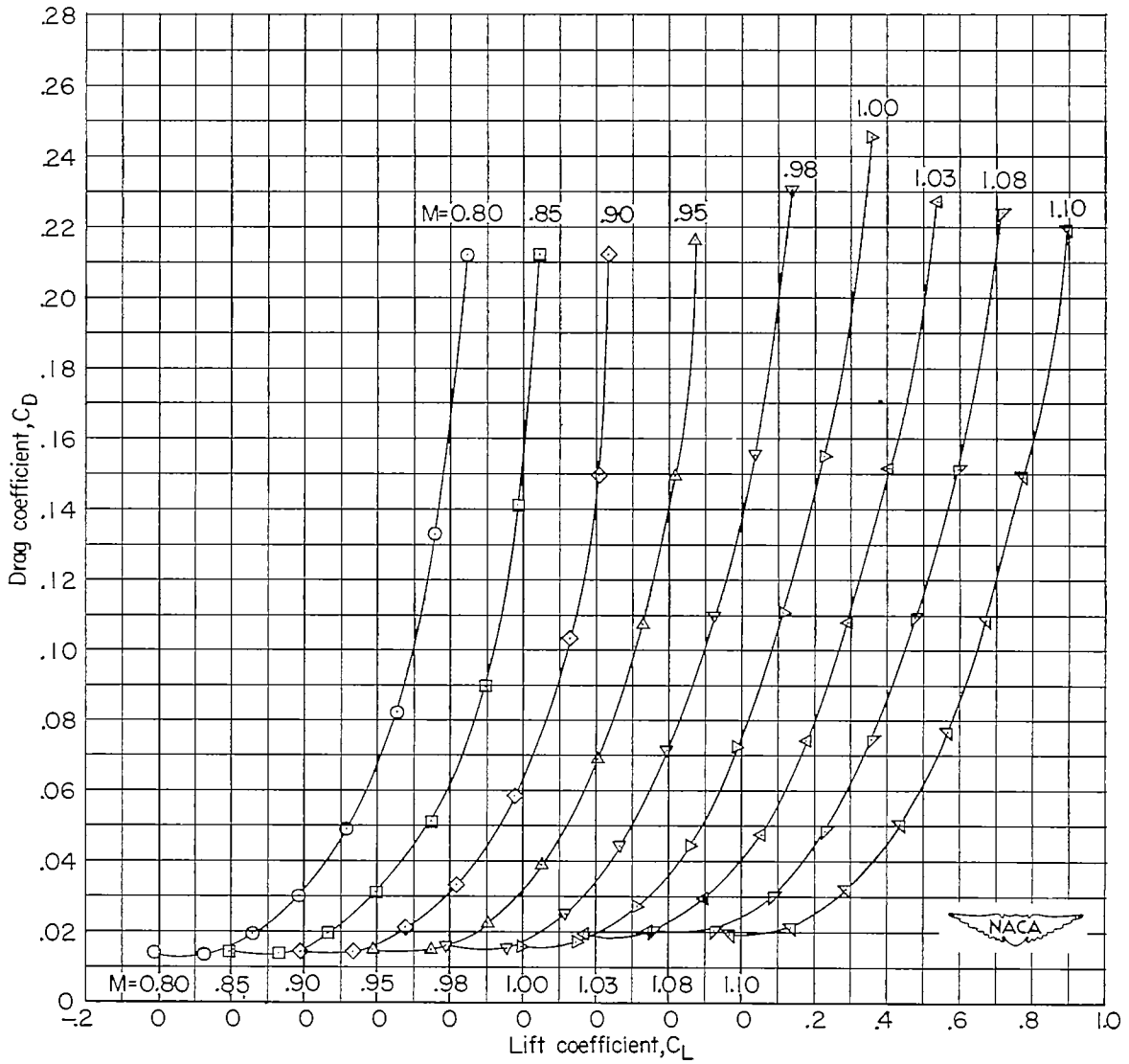

Figure 2.- Spanwise variation of the twist and camber of the twisted and cambered wing.



(a) Angle of attack.

Figure 3.- Variation with lift coefficient of the aerodynamic characteristics for the twisted and cambered wing--modified-fuselage configuration.



(b) Drag coefficient.

Figure 3.- Continued.

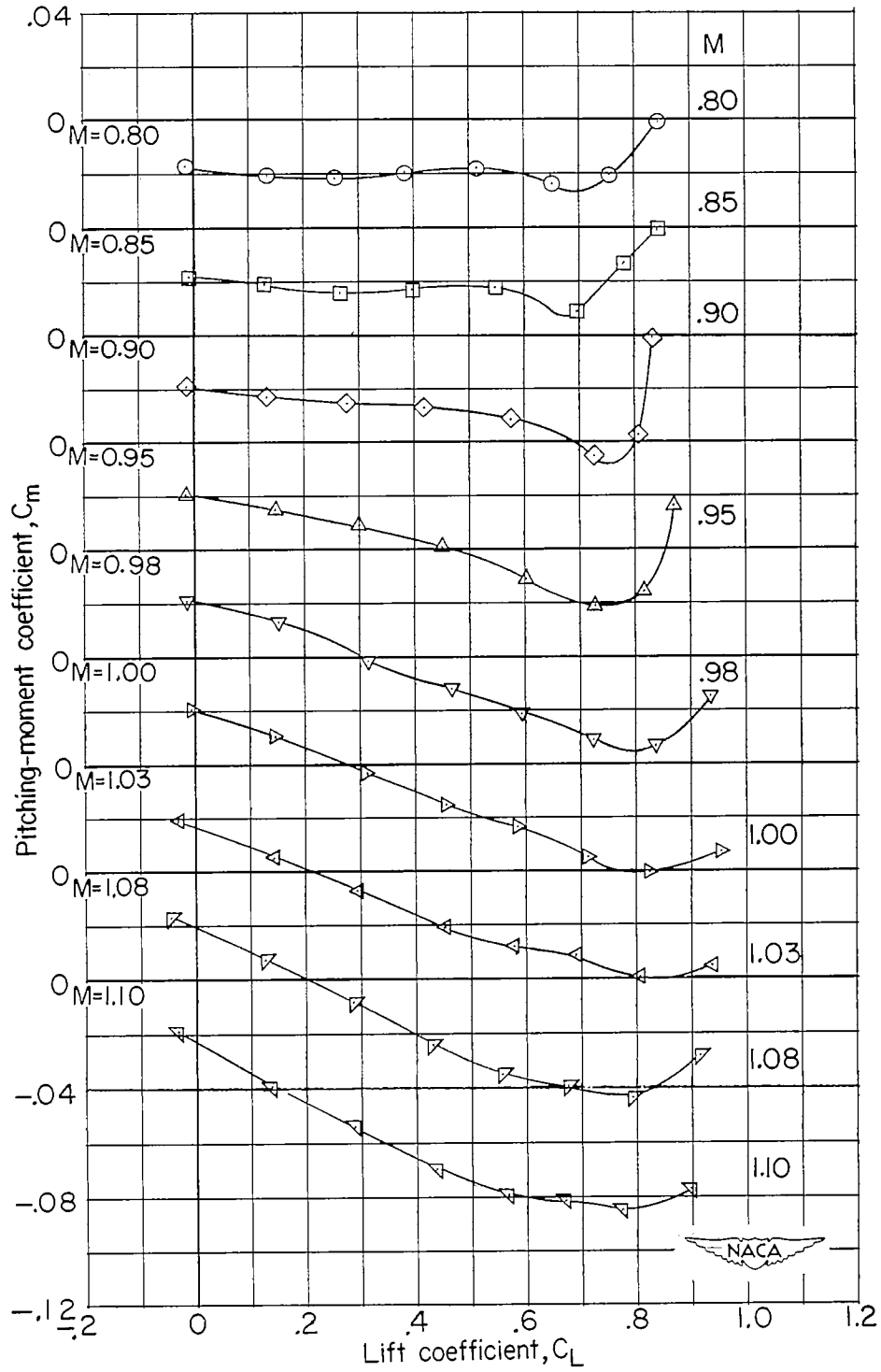

(c) Pitching-moment coefficient.

Figure 3.- Concluded.

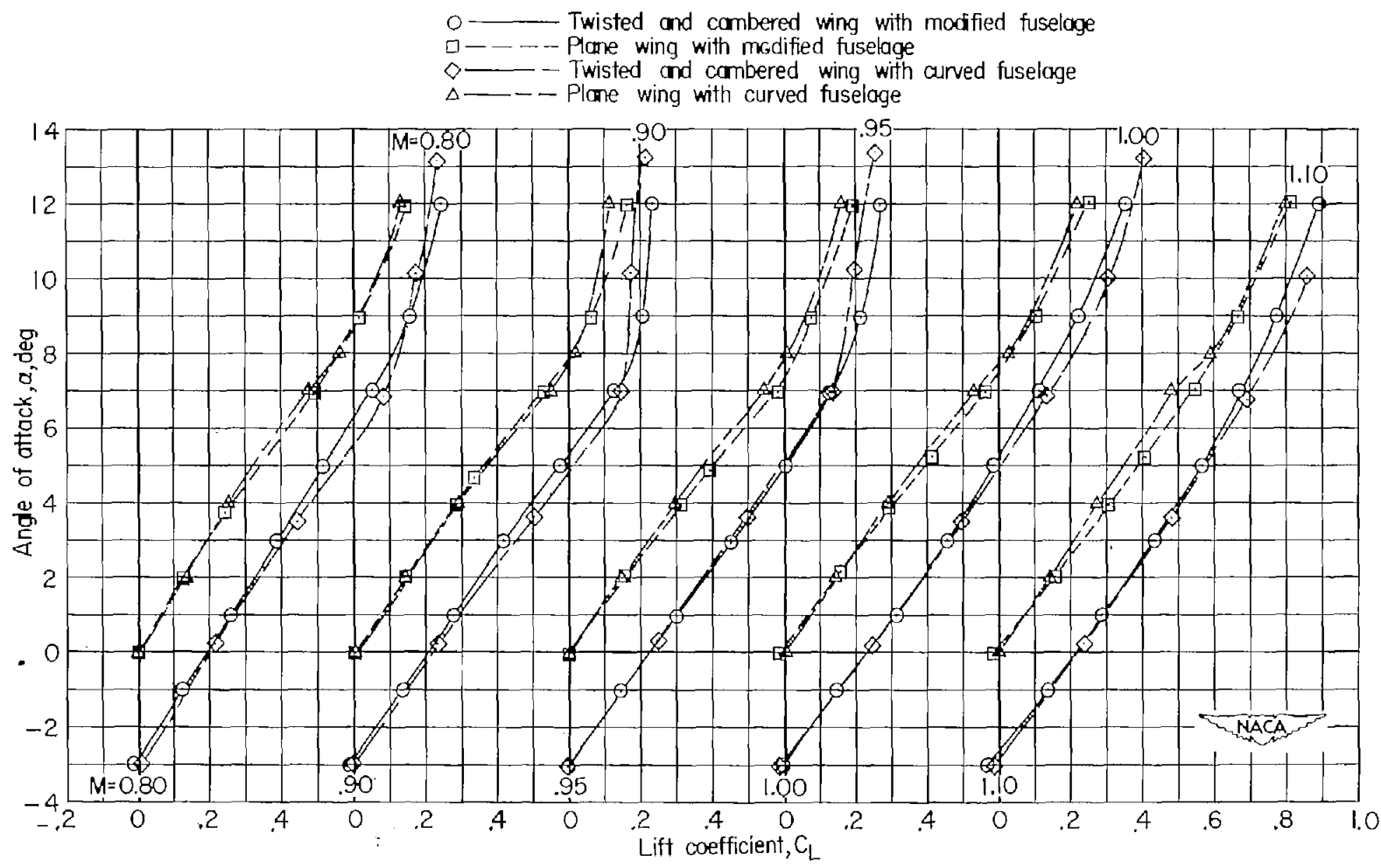

(a) Angle of attack.

Figure 4.- A comparison of the variations with lift coefficient of the aerodynamic characteristics for the twisted and cambered wing-fuselage configurations and the plane wing-modified-fuselage configuration.

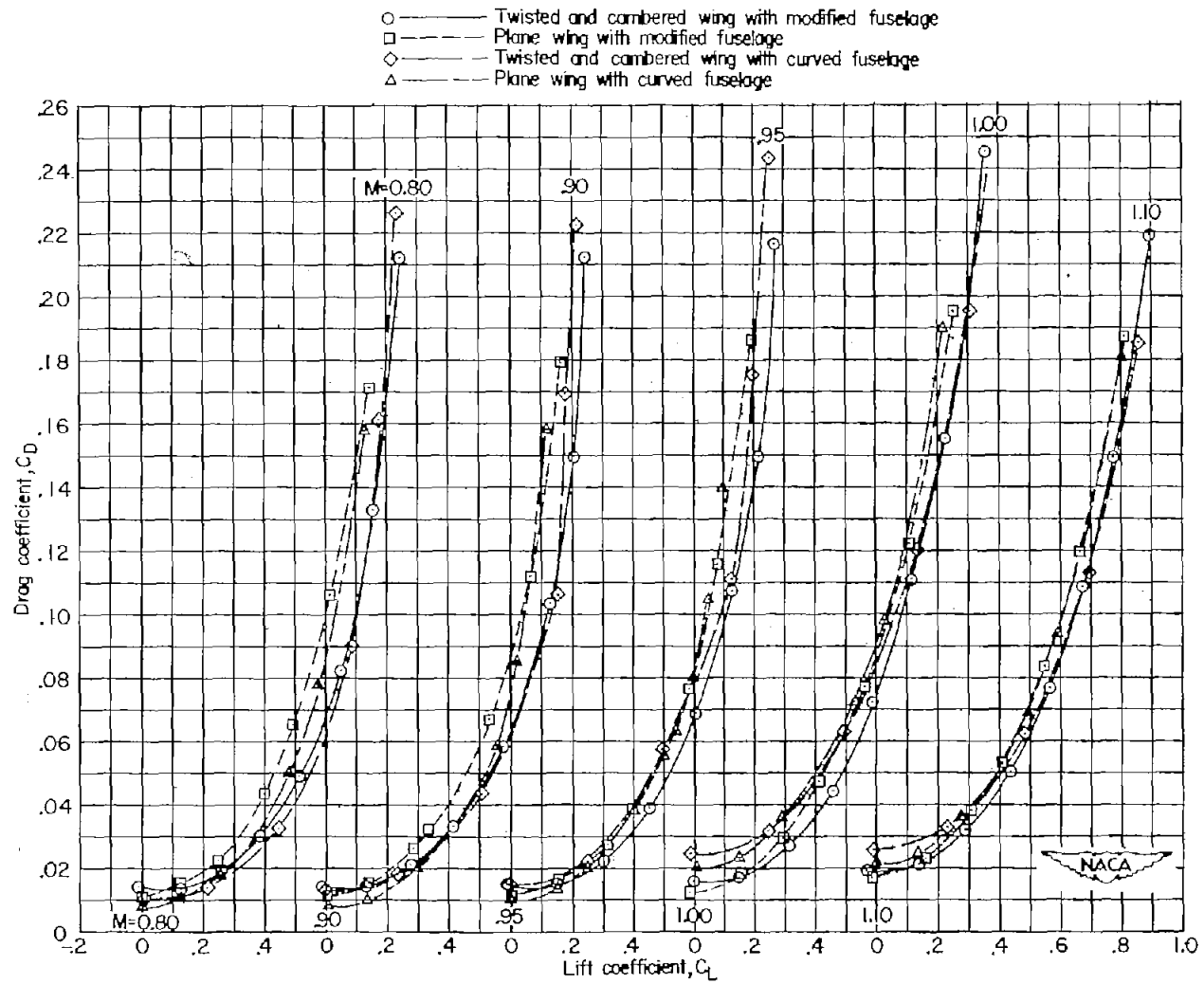

(b) Drag coefficient.

Figure 4.- Continued.

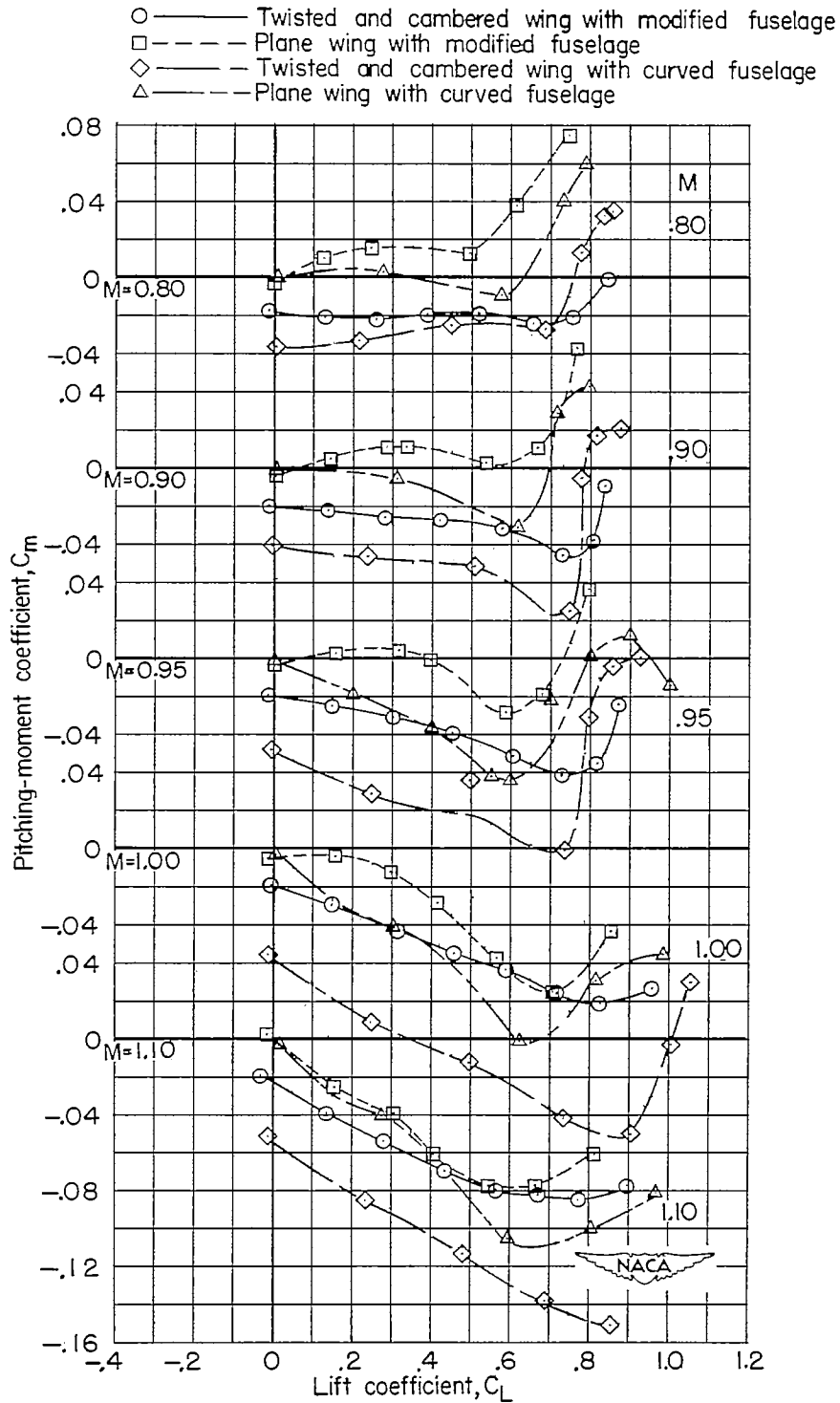

(c) Pitching-moment coefficient.

Figure 4.- Concluded.

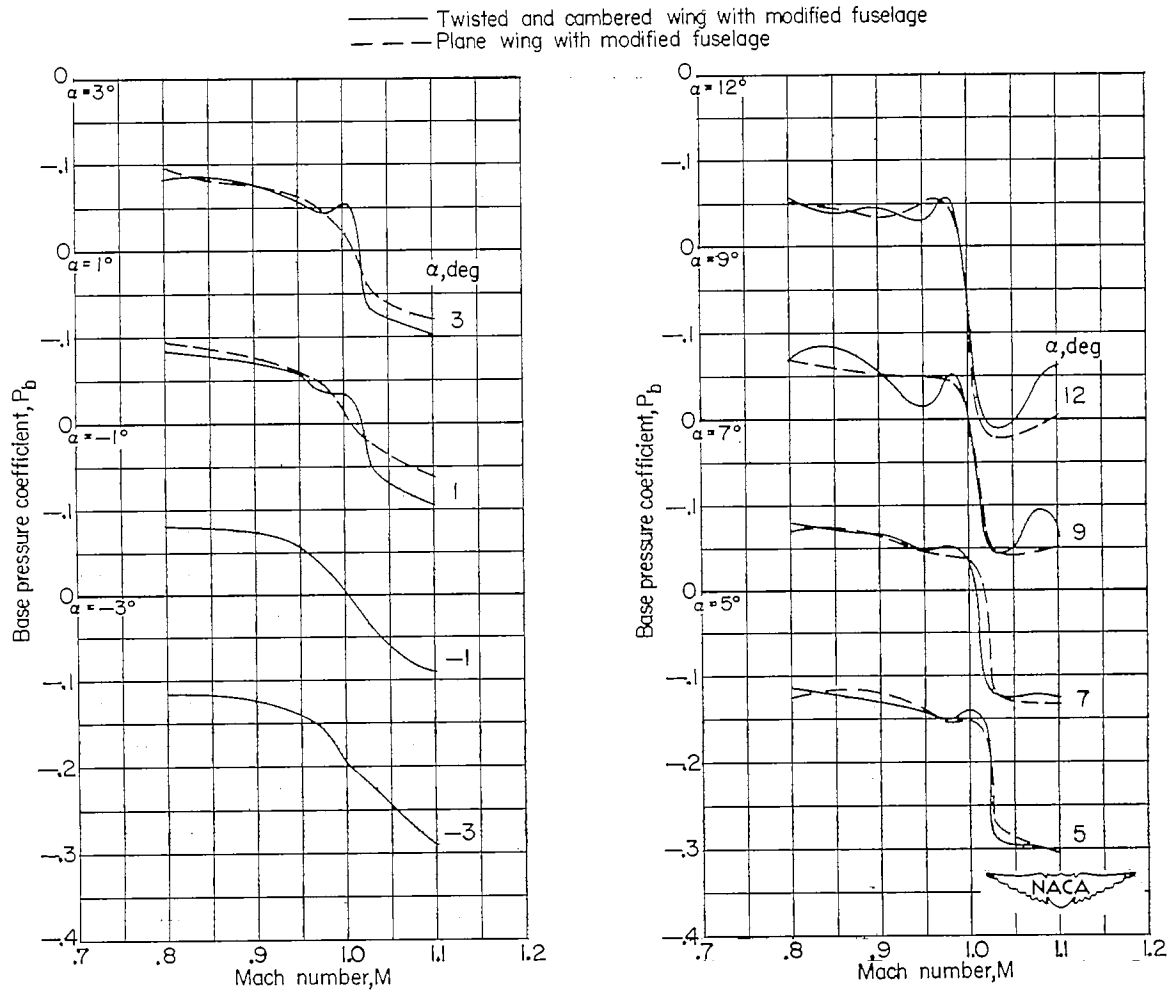

Figure 5.- Variation with Mach number of the base pressure coefficients for the twisted and cambered wing--modified-fuselage and the plane wing--modified-fuselage configurations.

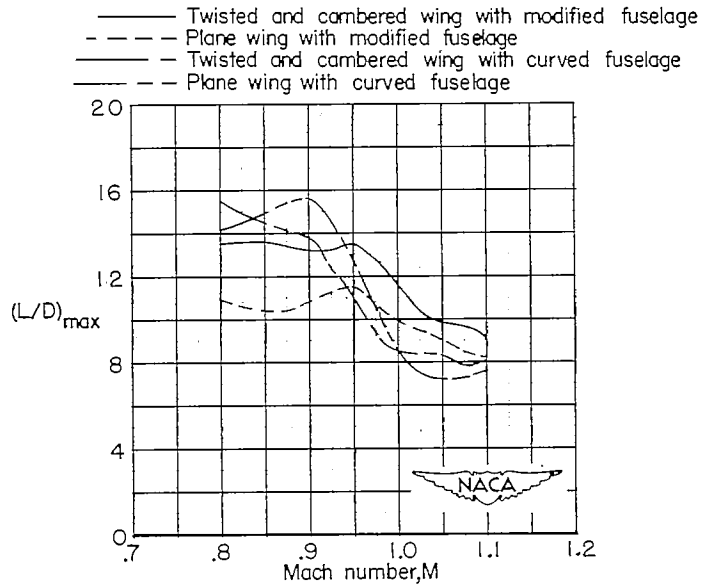

Figure 6.- The effects of twist and camber and fuselage modification on the variation of maximum lift-drag ratios with Mach number for the comparable wing-fuselage combinations.

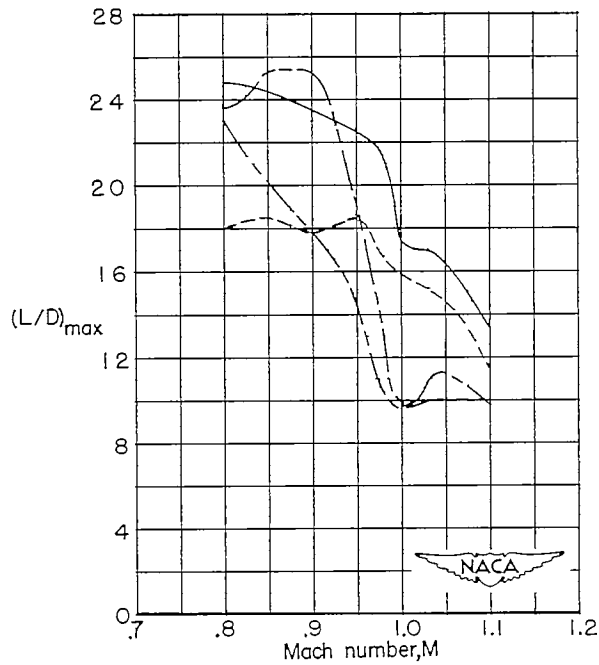

Figure 7.- The effects of twist and camber and fuselage modification on the variation of maximum lift-drag ratios with Mach number for the wing in the presence of the fuselage.

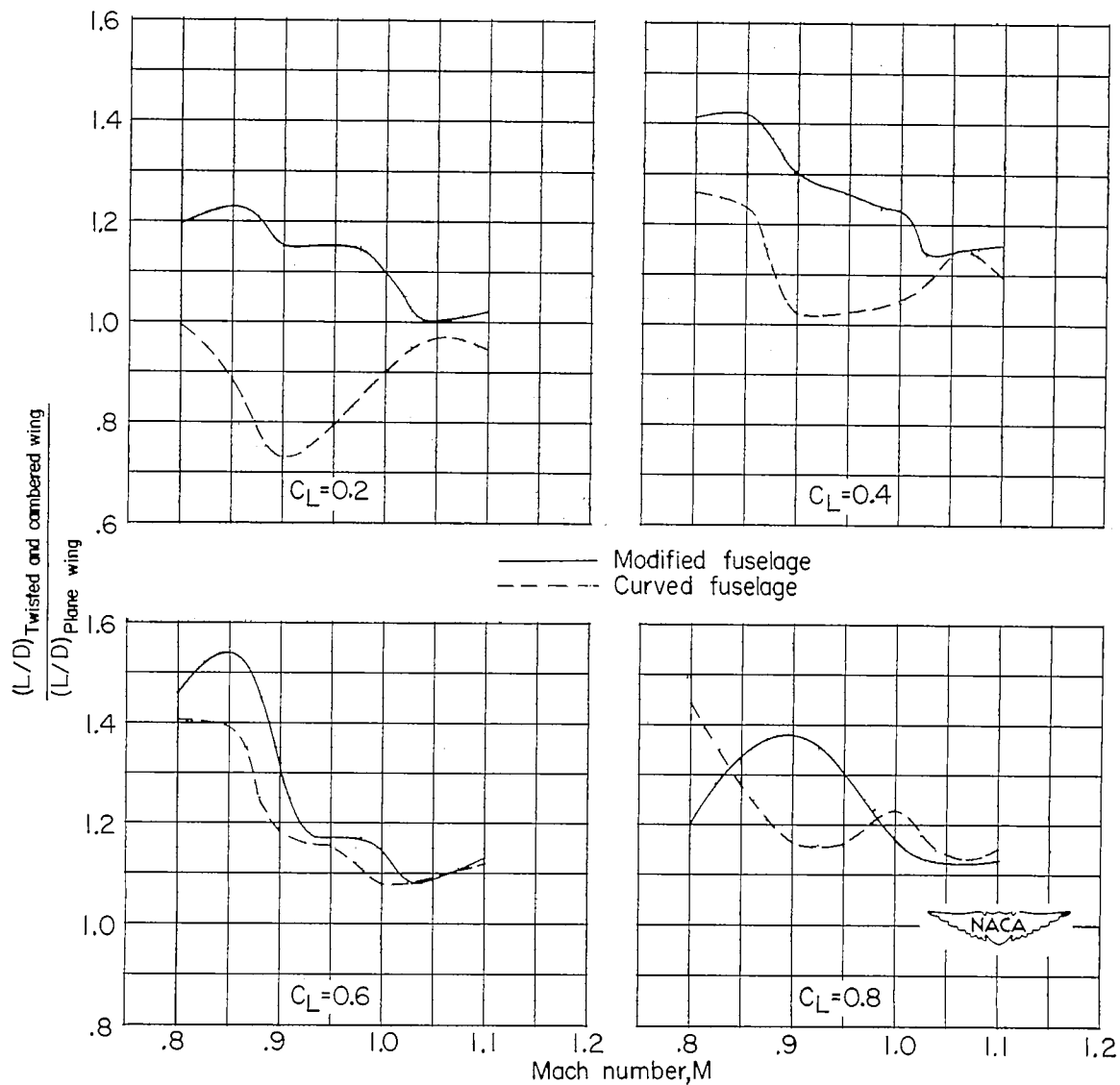

Figure 8.- The variations of increases in L/D values due to twist and camber with Mach number for the wing--modified-fuselage and the wing--curved-fuselage configurations at several lift coefficients.

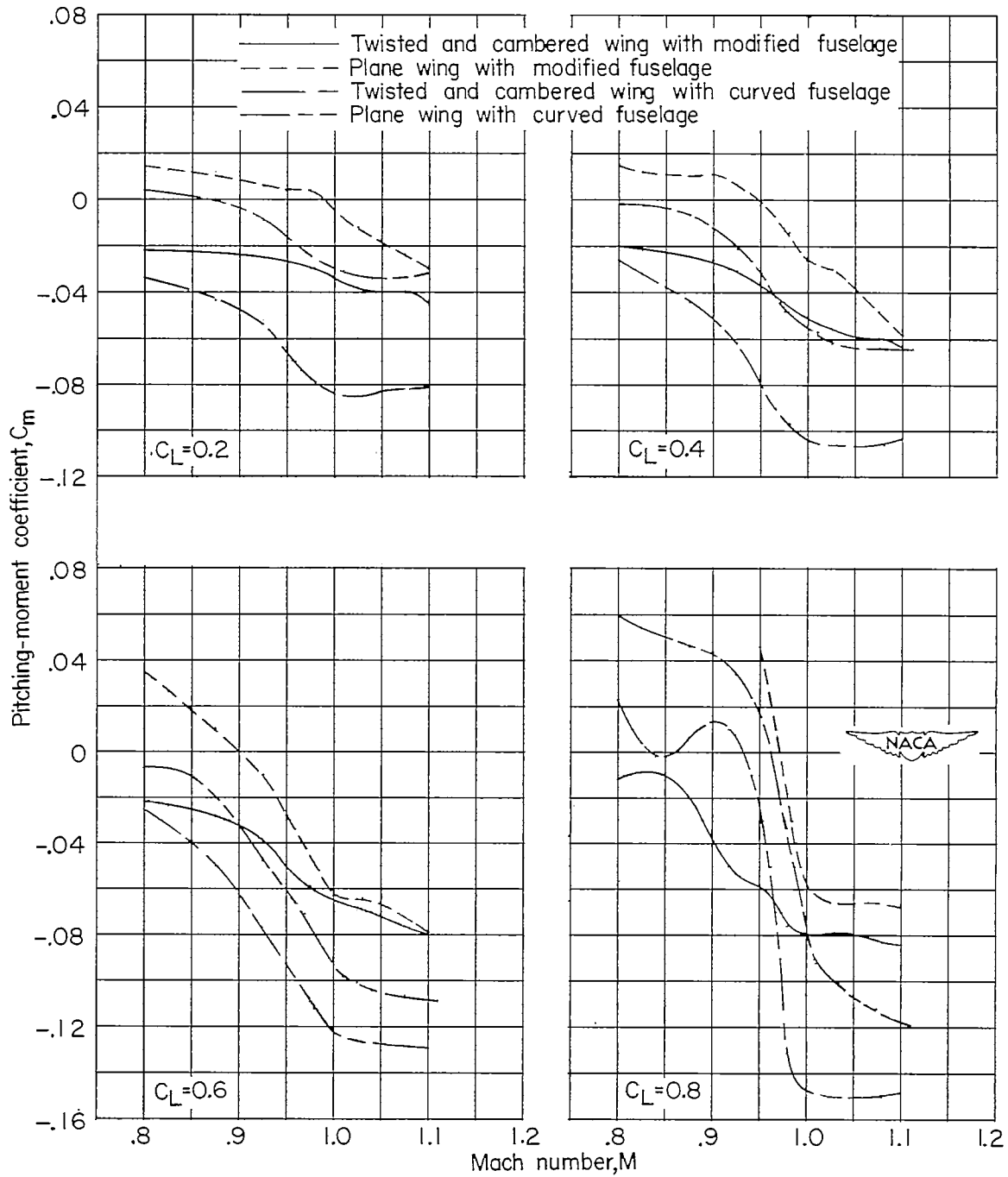

Figure 9.- Variation of pitching-moment coefficient with Mach number for the four comparable wing-fuselage configurations at several lift coefficients.