

NACA RM A53E21

11053



RESEARCH MEMORANDUM

INVESTIGATION OF THE USE OF A STICK FORCE PROPORTIONAL TO
PITCHING ACCELERATION FOR NORMAL-ACCELERATION WARNING

By Marvin Abramovitz, Stanley F. Schmidt,
and Rudolph D. Van Dyke, Jr.

Ames Aeronautical Laboratory
Moffett Field, Calif.

CLASSIFICATION CHANGED

To UNCLASSIFIED

By authority of NACA Res abs effective
PN-115 Date 5-8-57
at 5-23-57

CLASSIFIED DOCUMENT

This material contains information affecting the National Defense of the United States within the meaning of the espionage laws, Title 18, U.S.C., Secs. 793 and 794, the transmission or revelation of which in any manner to an unauthorized person is prohibited by law.

NATIONAL ADVISORY COMMITTEE FOR AERONAUTICS

WASHINGTON
August 14, 1953

NACA LIBRARY

AMES AERONAUTICAL LABORATORY
Moffett Field, Calif.



NATIONAL ADVISORY COMMITTEE FOR AERONAUTICS

RESEARCH MEMORANDUMINVESTIGATION OF THE USE OF A STICK FORCE PROPORTIONAL TO
PITCHING ACCELERATION FOR NORMAL-ACCELERATION WARNINGBy Marvin Abramovitz, Stanley F. Schmidt,
and Rudolph D. Van Dyke, Jr.

SUMMARY

The feasibility of modifying the transient portion of the stick force in abrupt maneuvers, in order to eliminate inadvertent normal-acceleration overshoots, is investigated both experimentally in flight and analytically. The modification consists of an additional stick force proportional to a quantity which leads the normal acceleration (e.g., pitching acceleration).

It is shown that the magnitude of force proportional to pitching acceleration which can be provided is severely limited by the dynamic stability characteristics of the control system. However, when enough lag is introduced so that the force is approximately in phase with rate of change of normal acceleration, very large forces can be provided without impairing the dynamic stability. The feel characteristics produced by the inclusion of such a force are considered to be very desirable by pilots. In addition to eliminating normal-acceleration overshoots, more precise maneuvers can be flown.

INTRODUCTION

Because of the increases in airplane size and speed and the attendant difficulties of aerodynamically balancing control surfaces, many designs now employ irreversible, powered controls with artificial feel. Although these devices provide satisfactory stick-force gradients in steady flight, they fail, in some cases, to furnish adequate stick-force characteristics in abrupt maneuvers, and thereby increase the danger of inadvertently overshooting the airplane load limit. (The required stick-force gradients in steady flight are specified in reference 1, but the nature of the transient stick force in abrupt maneuvers is mentioned only in a general way.)

This investigation is concerned with the feasibility of preventing the occurrence of these overshoots by modifying the transient portion of



the stick force to include an additional force which leads the normal acceleration. The pitching acceleration is a quantity that leads the normal acceleration, and its magnitude depends on both the rapidity and magnitude of the maneuver. It was felt that an additional stick force proportional to this quantity would warn the pilot of impending normal acceleration in time to take corrective action, if necessary, to prevent overshoots. For the investigation, an F-51H airplane equipped with a special torque servo, which produced an additional stick force proportional to a selected input quantity, was used as a test vehicle. The output of an angular accelerometer formed the input to the torque servo, thus producing the desired warning stick force.

NOTATION

a_z	normal acceleration, ft/sec ²
\bar{c}	wing mean aerodynamic chord, ft
$C_{h\alpha}$	rate of change of hinge-moment coefficient with angle of attack, per deg
$C_{h\dot{\theta}}$	rate of change of hinge-moment coefficient with pitching velocity, per radian per sec
$C_{L\alpha}$	airplane lift-curve slope, per radian
$C_{L\delta}$	elevator effectiveness, per deg
F_S	elevator stick force, lb
F_{S_H}	stick force due to elevator hinge moments, lb
F_{S_T}	stick-force output of torque servo, lb
g	acceleration of gravity, ft/sec ²
K	feedback gain, lb/radian/sec ²
K_H	steady-state value of δ/F_S , deg/lb
K_M	microsyn gearing, volts/deg
K_R	ram and amplifier gearing, deg/sec/volt
K_S	torque-servo gearing, lb/volt

K_{S_r}	ratio of stick deflection to elevator deflection for rigid control cables
K_T	torque-tube spring constant, lb stick force/deg
K_θ	steady-state value of $\dot{\theta}/\delta$, radians/sec/deg
p	variable introduced in the Laplace transformation
q	dynamic pressure, lb/ft ²
S	wing area, ft ²
T	lag-filter time constant, sec
T_S	torque-servo lag, sec
T_θ	airplane pitching lead term, sec
t	time, sec
$v_{\dot{\theta}}$	output of angular accelerometer, volts
V	flight speed, ft/sec
W	airplane weight, lb
δ	elevator angle, deg
ζ	airplane damping ratio in pitch
ζ_e	elevator damping ratio
θ	angle of pitch, radians
θ_R	torsion-bar rotation due to hydraulic ram deflection, deg
θ_S	control-stick deflection, deg
ω_n	airplane short-period natural frequency, radians/sec
ω_{n_e}	elevator natural frequency, radians/sec
ρ	air density, slugs/cu ft
$(\dot{\quad}), (\ddot{\quad})$	first and second time derivative, respectively

EQUIPMENT

Airplane

Figure 1 is a sketch of the test airplane. With the airplane normally loaded, the elevator-control-force characteristics are considered generally satisfactory in both steady and abrupt maneuvers. For the initial tests, the airplane was flown in the normal condition. However, for the final evaluation, ballast was added to the tail compartment to move the center of gravity aft in order to decrease the steady elevator-control-force gradients to values which vary from marginally acceptable to unacceptable, depending on the flight speed and altitude.

Torque Servo

Figure 2 is a sketch of the torque servo used to provide the additional force proportional to the pitching acceleration. The hydraulic ram is connected through the torsion bar to the stick linkage. The microsyn measures the torsion-bar twist and feeds a voltage proportional to this quantity back to the amplifier, which controls the ram velocity by means of the valve actuator. With no other input to the amplifier, the ram closely follows any stick movements. In order to provide a stick force proportional to pitching acceleration, the output of an angular accelerometer is fed to the amplifier. This added input causes the servo to maintain a torque on the torsion bar and, thus, a stick force proportional to the pitching acceleration.

Equipment Tests

Ground tests of the servo indicated satisfactory operation. With no angular-accelerometer input, the ram very closely followed even extremely rapid stick movements with negligible additional stick force. The stick-force output followed sudden electrical inputs with only small lag.

Initial flight tests to check out the servo operation in flight indicated that, although the servo performed satisfactorily, the usable system gain was severely limited by the stick-free dynamic stability. With the gain set to provide the amount of additional stick force initially estimated by pilots as being necessary for warning purposes (about 40 lb/radian/sec²), the system had oscillatory instability when the stick was released. Figure 3 is taken from flight records to illustrate the condition at a lower gain (13 lb/radian/sec²) where the system is still oscillatory. At even lower gains where the system was stable,



though poorly damped, the system oscillated for many cycles even in attempted stick-fixed maneuvers, and the pilot rated it unsatisfactory.

As a result of the initial tests, an analytical study was instituted to determine and eliminate the causes of the instability and still provide adequate normal-acceleration warning.

ANALYTICAL STUDY

Method of Analysis

The analytical study was carried out using a high-speed electronic simulator. With the torque servo feeding back a stick force proportional to the pitching acceleration, this acceleration being a quantity which depends on the stick-force input, the control system is a closed loop defined by the following equations:

$$\left. \begin{aligned} \text{or} \quad & F_S = F_{S_H} + F_{S_T} \\ & F_{S_H} = F_S - F_{S_T} \end{aligned} \right\} \quad (1)$$

in which $\ddot{\theta}$ depends on δ which is a function of F_{S_H} , and F_{S_T} is a function of $\ddot{\theta}$. A block diagram of the system appears in figure 4.

The complete aerodynamic equations of motion, including the control-free mode, are given in reference 2. However, for the purposes of this investigation, several simplifying assumptions can be made. Preliminary flight-test results indicated that the hinge moments depend primarily on the elevator deflection, so that terms which depend on the aerodynamic response ($C_{h\alpha}$, $C_{h\dot{\alpha}}$, etc.) may be neglected. In addition, the following assumptions, which are considered reasonable for the configuration being investigated, were made: (1) constant forward speed, (2) $C_{L\delta} = 0$, (3) rigid control cables, (4) system mass balanced. With these assumptions, the equations of motion can be considerably simplified and aerodynamic transfer functions of the following form can be determined:

$$\left. \begin{aligned}
 \frac{\ddot{\theta}}{\delta} &= \frac{K_{\theta}(1 + T_{\theta}p)p}{1 + (2\zeta/\omega_n)p + (1/\omega_n^2)p^2} \\
 \frac{a_z/g}{\delta} &= \frac{(V/g)K_{\theta}}{1 + (2\zeta/\omega_n)p + (1/\omega_n^2)p^2} \\
 \frac{\delta}{F_{S_H}} &= \frac{K_H}{1 + (2\zeta_e/\omega_{n_e})p + (1/\omega_{n_e}^2)p^2}
 \end{aligned} \right\} (2)$$

The torque-servo transfer function is derived in the appendix. Experimental data indicated that the portion of the stick force due to rate of stick movement was negligible, so that the simplified form of the transfer function was used in the analysis.

$$\frac{F_{S_T}}{v_{\delta}} = \frac{K_S}{1 + T_S p} \quad (3)$$

where $T_S = 0.02$.

The angular accelerometer was represented by a second-order transfer function with a natural frequency of 9 cycles per second and a damping ratio of 0.7 to correspond to the characteristics of the instrument used in flight.

The system defined by the previous equations was set up on the electronic simulator for conditions corresponding to the initial flight tests — an indicated airspeed of 200 miles per hour at an altitude of 10,000 feet with a normal center-of-gravity location (about 25-percent \bar{c}). The aerodynamic and control-system dynamic parameters were estimated theoretically and modified slightly to fit the flight data. Table I lists the aerodynamic and control-system dynamic parameters used.

In a combination force-and-position system such as the one investigated herein, three different modes of operation can be visualized: stick-free, in which the pilot frees the stick after an initial input; stick-fixed, in which the pilot holds a constant control position

regardless of stick-force variation; and constant force, in which the pilot varies the control position to maintain a constant stick force. For the stick-fixed condition, no instability can appear since the control is not allowed to oscillate. The three conditions above were approximated on the simulator by using a square pulse input in F_S for the stick-free case, opening the loop and forming $F_{S_H} + F_{S_T}$ for a step F_{S_H} input for the stick-fixed case, and using a step input in F_S to the closed-loop system for the constant-force case.

Results

Figure 5 is a simulated time history of elevator position in response to a pulse input in stick force with a gain of 15 pounds per radian per second squared. It is seen that, even with the large number of simplifications made above, the analytical solution approximates the flight result very closely. In order to determine what factors were limiting the usefulness of the system, several of the parameters were varied and the effects on the system response were observed. It was found that only small increases in the usable gain could be obtained when the servo lag was decreased and the control-system natural frequency increased. The latter could correspond to either less control-system inertia or to an irreversible, powered control system with spring feel and high-performance control servos. Also, the aerodynamic parameters were varied to simulate those of airplanes varying from a very large transport to a transonic fighter. There resulted little effect on the system characteristics. However, T_θ , the lead term in the pitching-acceleration transfer function, was found to have a large effect. When this term was reduced to zero, which could be accomplished experimentally by the use of a lag network with a time constant equivalent to T_θ , large increases in the gain could be tolerated. Note from equations (2) that this is equivalent dynamically to feeding back (\dot{a}_z/g) rather than δ .

The reason that T_θ has such a large effect can be appreciated by examination of the system frequency response. Figures 6(a) and 6(b), respectively, are the amplitude ratios and phase angles for both the complete-system open-loop response (F_{S_T}/F_{S_H}) and the airplane pitching-acceleration response ($\ddot{\delta}/\delta$). Because of the relatively large value of T_θ and the fact that the pitching-acceleration transfer function is a derivative function (i.e., p occurs as a factor in the numerator), large amplitude ratios result at high frequencies where the phase lag is increasing. When the servo- and control-system lags are added and the loop is closed, very small gains must be used or the system will become unstable due to these large amplitude ratios. In examining the transfer coefficients of a number of airplanes, it was noted that $T_\theta \left(\approx \frac{2(W/S)}{g\rho V C_{L\alpha}} \right)$ is relatively large, so that the same fundamental limitations on the usefulness of the δ signal probably exist for these airplanes.

In order to determine the effect of the time lag on the g warning characteristics of the system, a variable-time-constant filter was added to the setup. This filter altered the output of the angular accelerometer. In figure 7 appear the stick-fixed responses with several different values of gain, K , and filter time constant, T . The amount of gain was chosen so that the stick-free oscillations damped to $1/10$ amplitude in approximately one cycle. It is seen that as the filter lag is increased, the amount of warning stick force can be increased. However, the amount of lead of the warning stick force over the normal acceleration is decreased. It was felt that the suitability of the system with the reduced lead and the optimum settings could be determined only in flight from pilots' reactions and opinions.

FLIGHT EVALUATION

The test airplane was equipped with a filter network in the torque-servo amplifier, which would affect only the angular-accelerometer output, and with a time constant which could be conveniently varied in flight. In addition, ballast was added to the tail compartment to move the center of gravity aft to about 31-percent \bar{c} , for which condition the stick-force gradient varied from about 0 to 3 pounds per g over the speed and altitude range. It was felt that, with very low, steady stick-force gradients, the pilots could evaluate more realistically the usefulness of the additional force in preventing overshoots. The evaluation was carried out at two flight conditions: 20,000 feet and 200 miles per hour where T_{θ} is large, and at 10,000 feet and 350 miles per hour where T_{θ} is small. Figure 8 shows the computed variation of T_{θ} with speed and altitude.

The tests were flown by two different pilots and, in general, their opinions on the suitability of the servo as a g warning device and their selections of optimum settings were in agreement. At both flight conditions they selected filter time constants very nearly equal to T_{θ} in order to obtain sufficiently high gains (130 to 170 lb/radians/sec²), so that 30 to 50 pounds of additional stick force were present in abrupt pull-ups to 3g. However, at the low-speed condition, where T_{θ} equals approximately 0.9 second, the lag introduced by the filter was more noticeable, and they felt that a filter time constant slightly less than T_{θ} (between $0.8 T_{\theta}$ and $0.9 T_{\theta}$) might be more desirable, even though it meant reducing the amount of warning stick force in order to maintain satisfactory stability. It should be pointed out that gain values were chosen in rapid pull-ups and turn entries to 3g's and, for this reason, are probably higher than optimum values selected on a basis of the airplane load limit (about 7g's). However, because of the very small maneuver margin corresponding to the aft center-of-gravity location, it was not considered feasible to attempt rapid pull-ups to large accelerations.

Both pilots considered the feel introduced by the additional stick force to be desirable, even with the necessary filter lag included. In rapid pull-ups and turn entries to a given acceleration, overshoots, which almost invariably occurred with the device turned off, were largely eliminated, and the pilots felt that it was much easier to make precise maneuvers. In figure 9 are typical rapid pull-ups which illustrate the effect of the device on the acceleration overshoot. By comparison of figures 9(a) and 9(b) it is seen that an overshoot of about 35 percent is present with the device off, while with the device operating the overshoot is largely eliminated with only a small decrease in the rapidity of the maneuver. An additional advantage was also noted by the pilots during the tests. They found it very difficult to maintain a constant g maneuver with the device off, especially in rough air. However, with the device operating, a much more precise maneuver could be flown. Figures 10(a) and 10(b), taken from flight records in which rough air was encountered, illustrate this point.

CONCLUSIONS

The feasibility of modifying the transient portion of the stick force in abrupt maneuvers, in order to eliminate inadvertent normal-acceleration overshoots, was investigated both experimentally in flight and analytically. The modification consisted of an additional force proportional to a quantity which leads the normal acceleration (e.g., pitching acceleration). It was determined that:

1. It was not possible to use pitching acceleration directly as an input quantity because of the severe limitations imposed by the stick-free dynamic stability characteristics on the magnitude of force which could be provided.
2. If enough lag were provided to make the force approximately in phase with the rate of change of normal acceleration, very large forces could be provided.
3. The feel characteristics introduced by the inclusion of such a force were considered to be very desirable by pilots. In addition to almost completely eliminating normal-acceleration overshoots, more precise control in maneuvers was possible, especially in rough air.

Ames Aeronautical Laboratory
National Advisory Committee for Aeronautics
Moffett Field, Calif., May 21, 1953



APPENDIX A

TORQUE-SERVO EQUATIONS

With reference to figure 4, the following equations can be written describing the action of the torque servo:

$$\left. \begin{aligned} F_{S_T} &= K_T(\theta_R - \theta_S) \\ \theta_R &= \frac{K_R}{P} [v_{\dot{\theta}} - K_M(\theta_R - \theta_S)] \end{aligned} \right\} \quad (A1)$$

If we solve for F_{S_T} , the following transfer function can be derived:

$$F_{S_T} = \frac{(K_T/K_M)v_{\dot{\theta}}}{1 + P/K_R K_M} - \frac{(1/K_R)(K_T/K_M)\dot{\theta}_S}{1 + P/K_R K_M} \quad (A2)$$

These equations assumed no lag in the ram, valve, valve actuator, and amplifier. The added assumption (verified by experimental tests) can be made that the action of the ram is so rapid (i.e., K_R is so large) that the term defining the stick force due to the rate of stick movement can be neglected, so that

$$\frac{F_{S_T}}{v_{\dot{\theta}}} = \frac{K_T/K_M}{1 + P/K_R K_M} = \frac{K_S}{1 + T_{SP}P} \quad (A3)$$

REFERENCES

1. Anon.: Flying Qualities of Piloted Airplanes. U. S. Air Force Specification No. 1815-B, June 1, 1948.
2. Greenberg, Harry, and Sternfield, Leonard: A Theoretical Investigation of Longitudinal Stability of Airplanes with Free Controls Including Effect of Friction in Control System. NACA Rep. 791, 1944.

TABLE I.- AERODYNAMIC AND CONTROL-SYSTEM DYNAMIC STABILITY PARAMETERS
FOR AN ALTITUDE OF 10,000 FEET AND AN
INDICATED AIRSPEED OF 200 mph

K_{θ} , radians/sec/deg	-0.0474
T_{θ} , sec	0.80
ζ , dimensionless	0.455
ω_n , radians/sec	2.96
K_H , lb/deg	-0.25
ζ_e , dimensionless	0.50
ω_{ne} , radians/sec	40



NACA

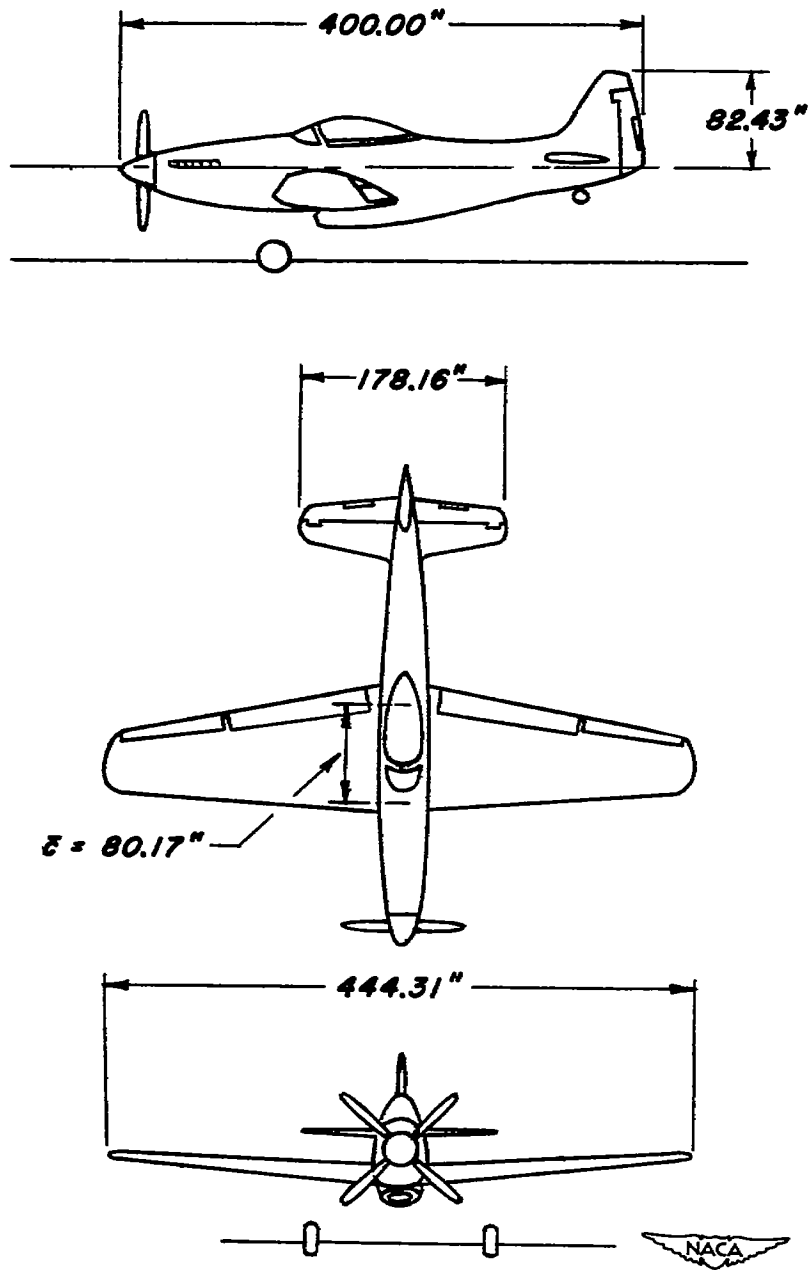

Figure 1.- Sketch of test airplane.

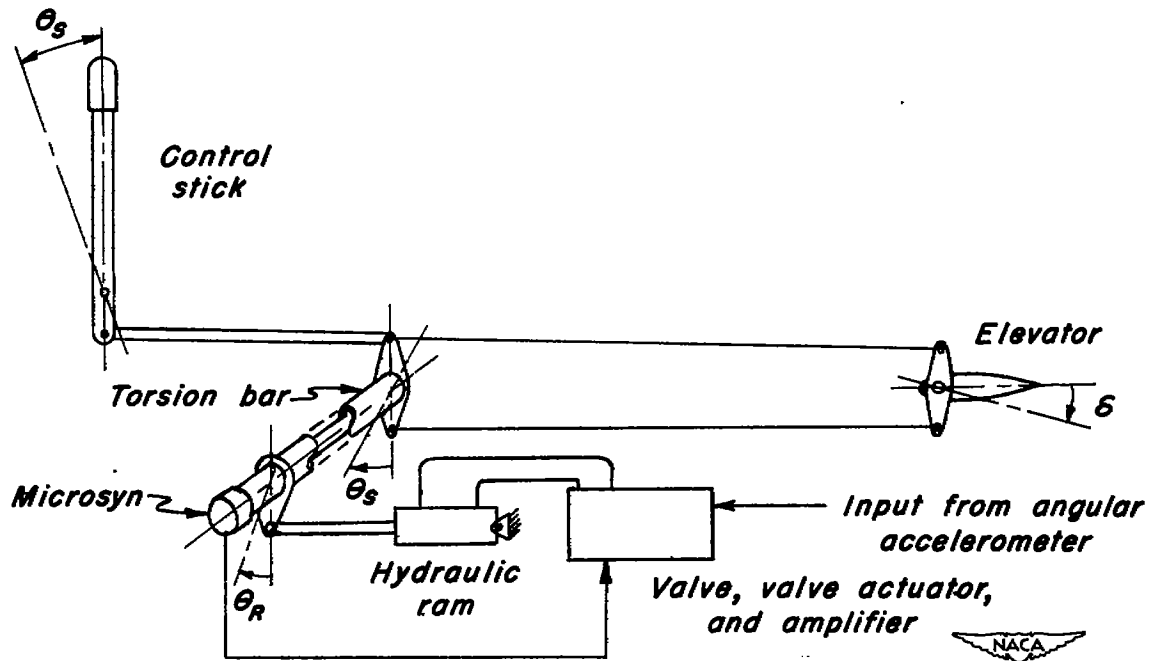

Figure 2.- Sketch of torque servo.

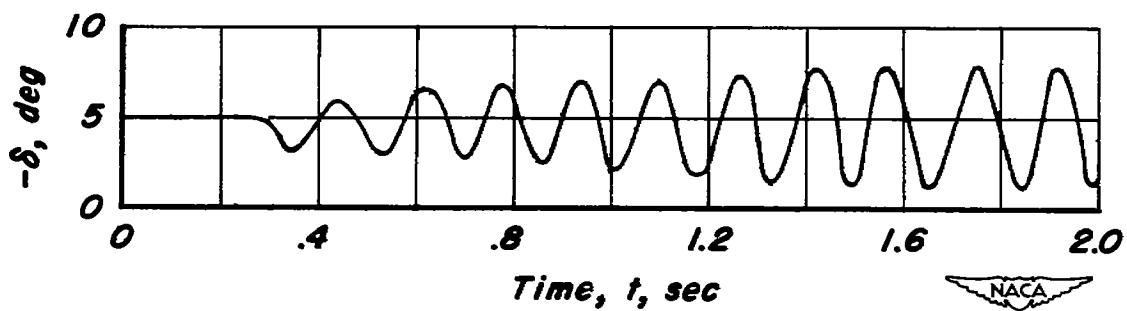

Figure 3.- Control-free elevator oscillation in flight
($K = 13 \text{ lb/radian/sec}^2$).

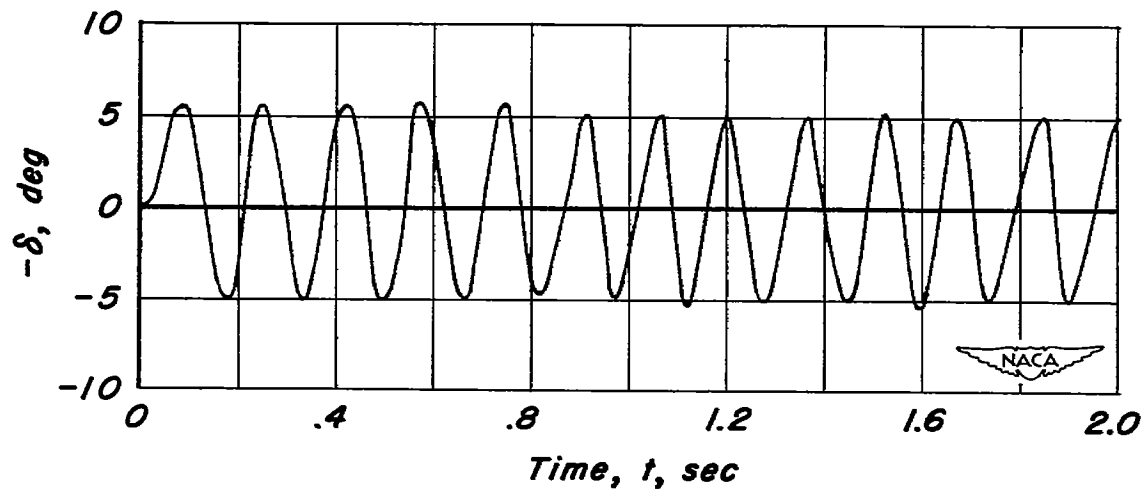
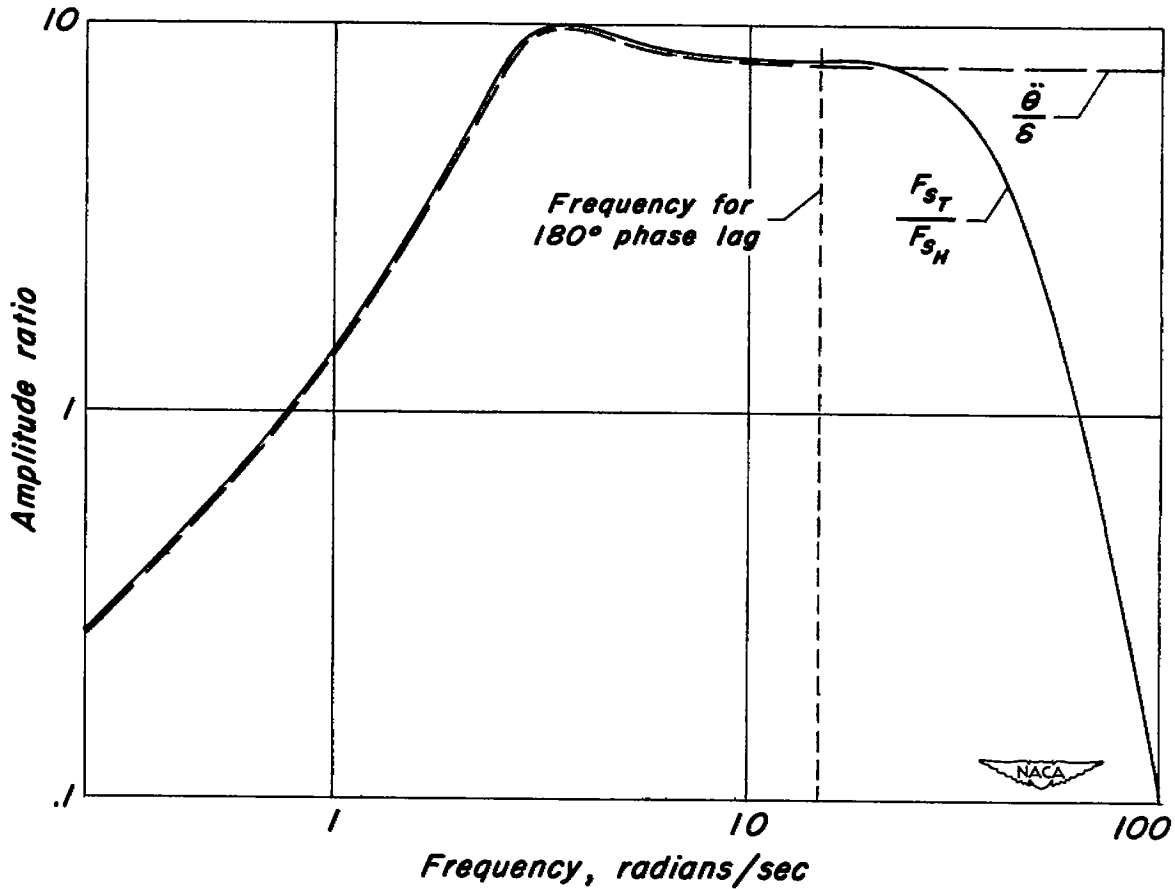
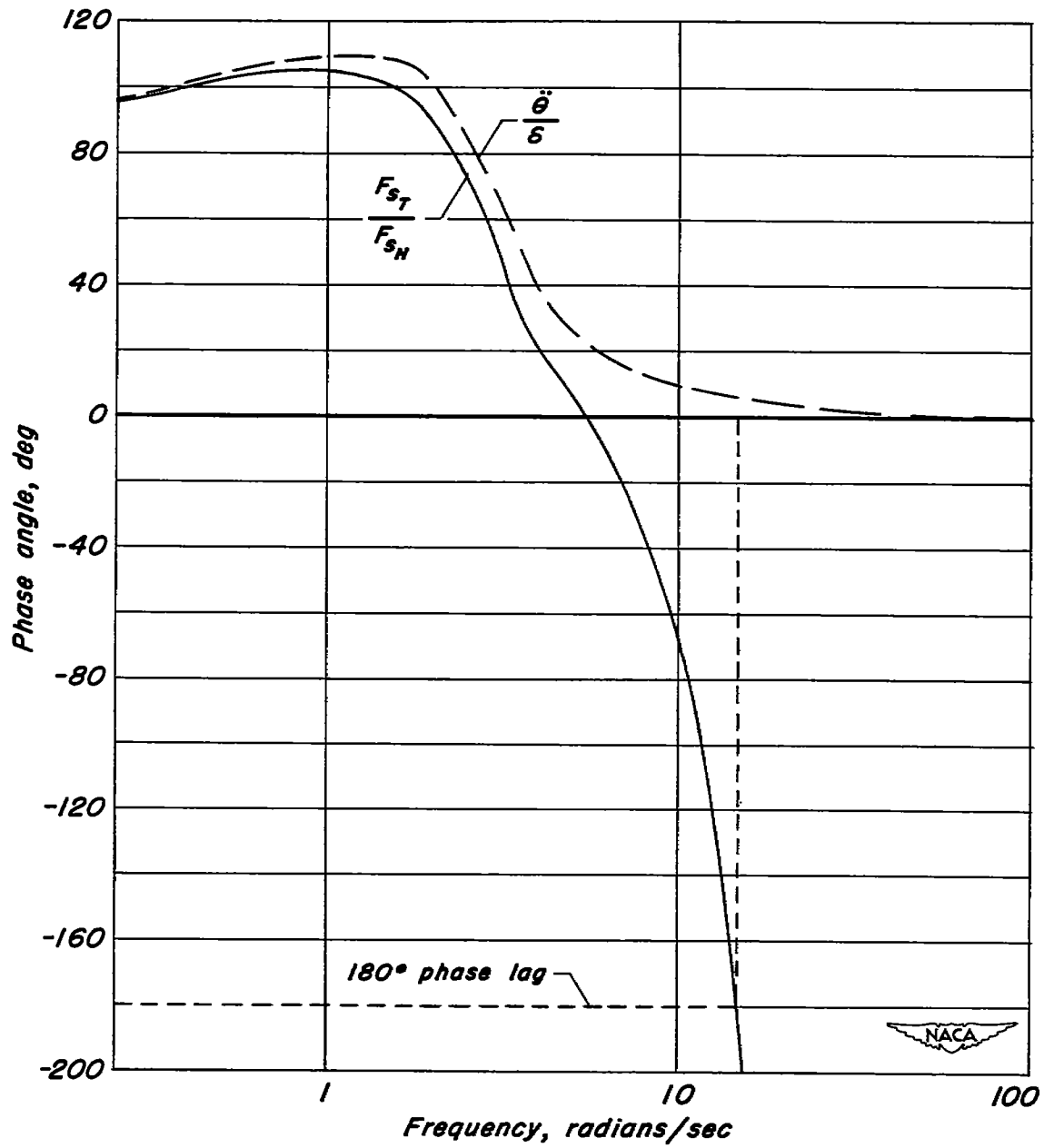

Figure 5.- Computed control-free elevator oscillation
($K = 15 \text{ lb/radian/sec}^2$).



(a) Amplitude ratios.

Figure 6.- Calculated airplane pitching acceleration and complete-system open-loop frequency responses for unity open-loop gain.



(b) Phase angles.

Figure 6.- Concluded.

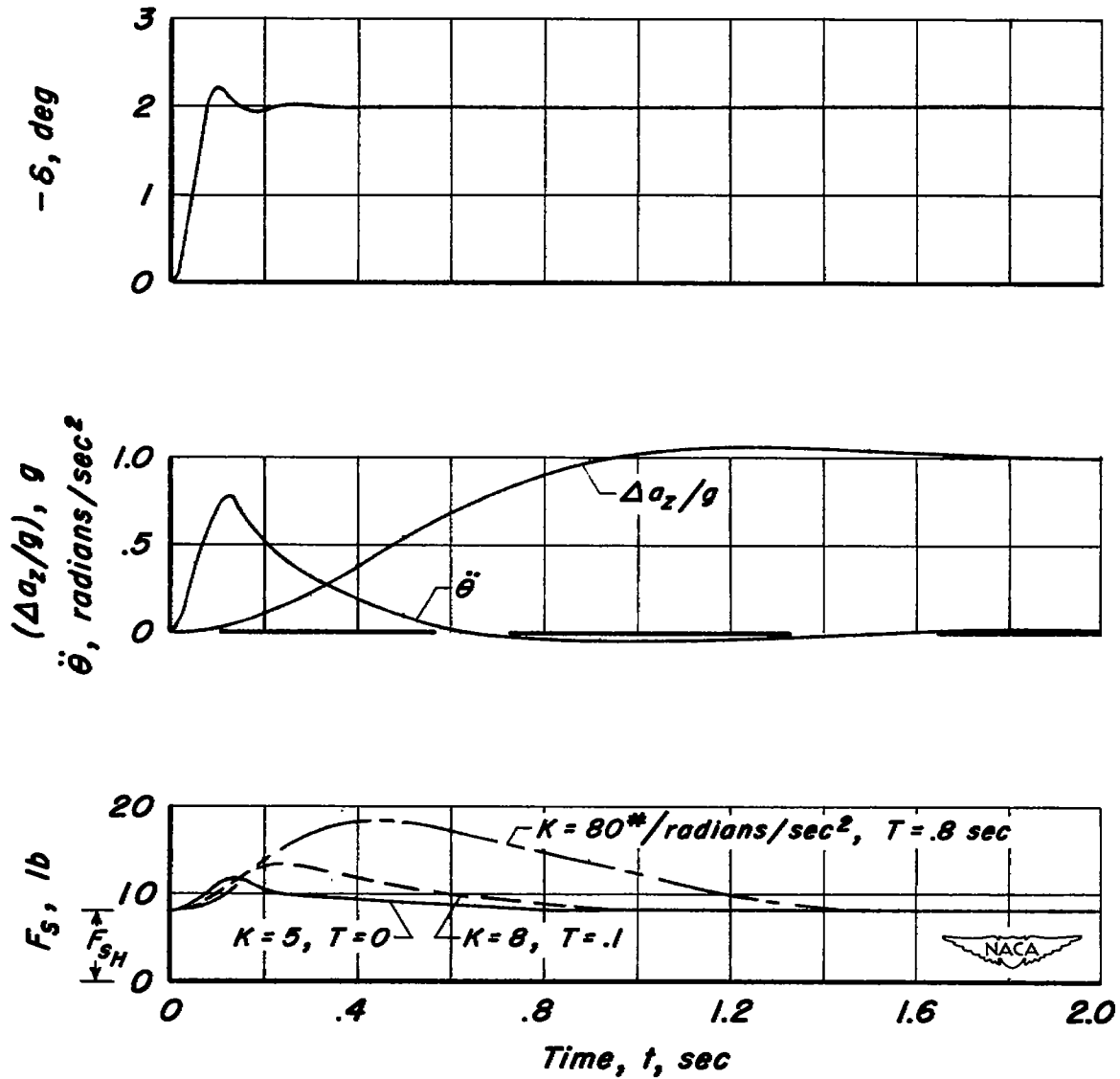

Figure 7.- Computed stick-fixed responses to a step in F_{SH} for different values of gain, K , and filter lag, T , which result in stick-free responses that damp to 1/10 amplitude in about 1 cycle.

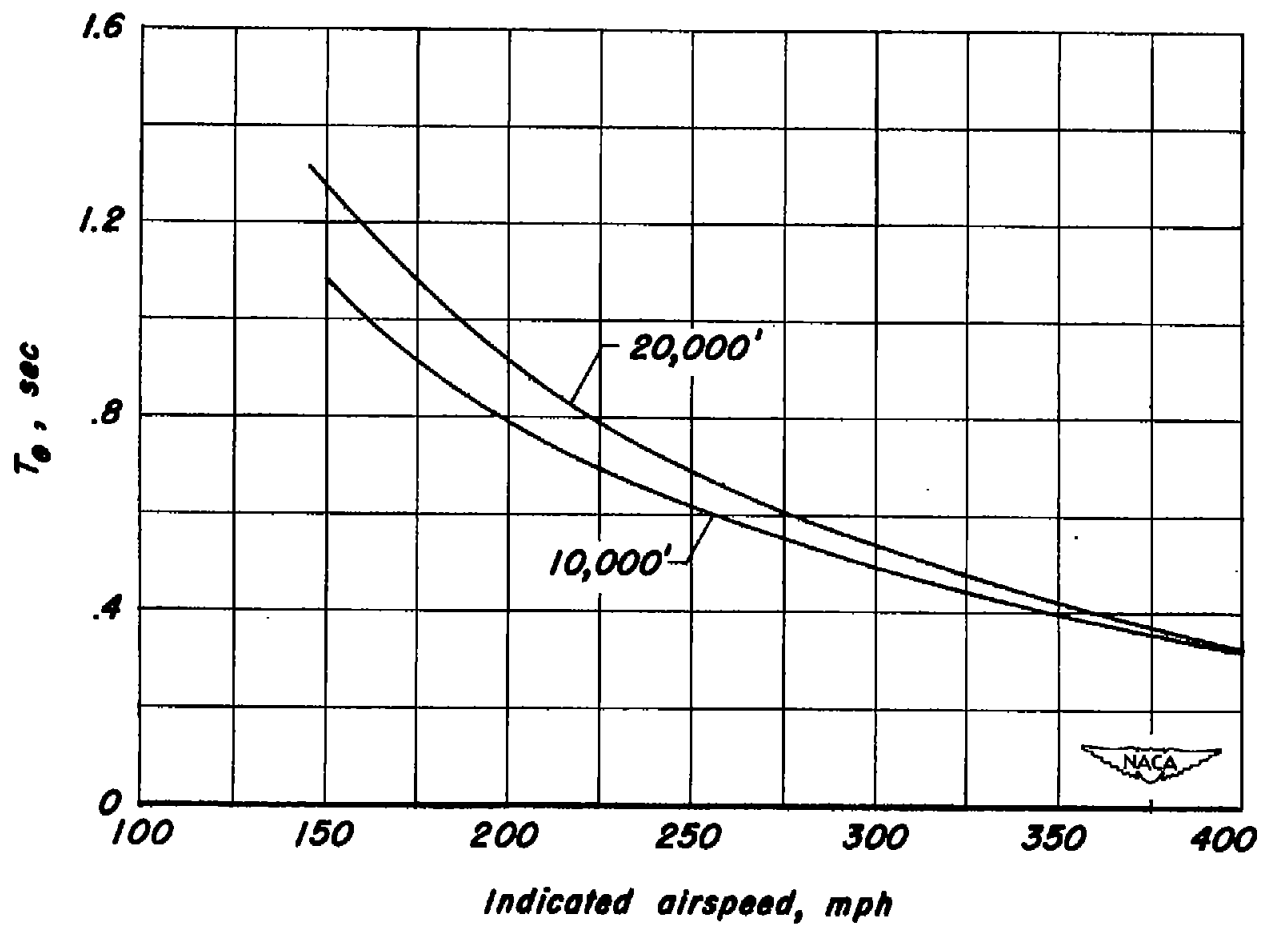
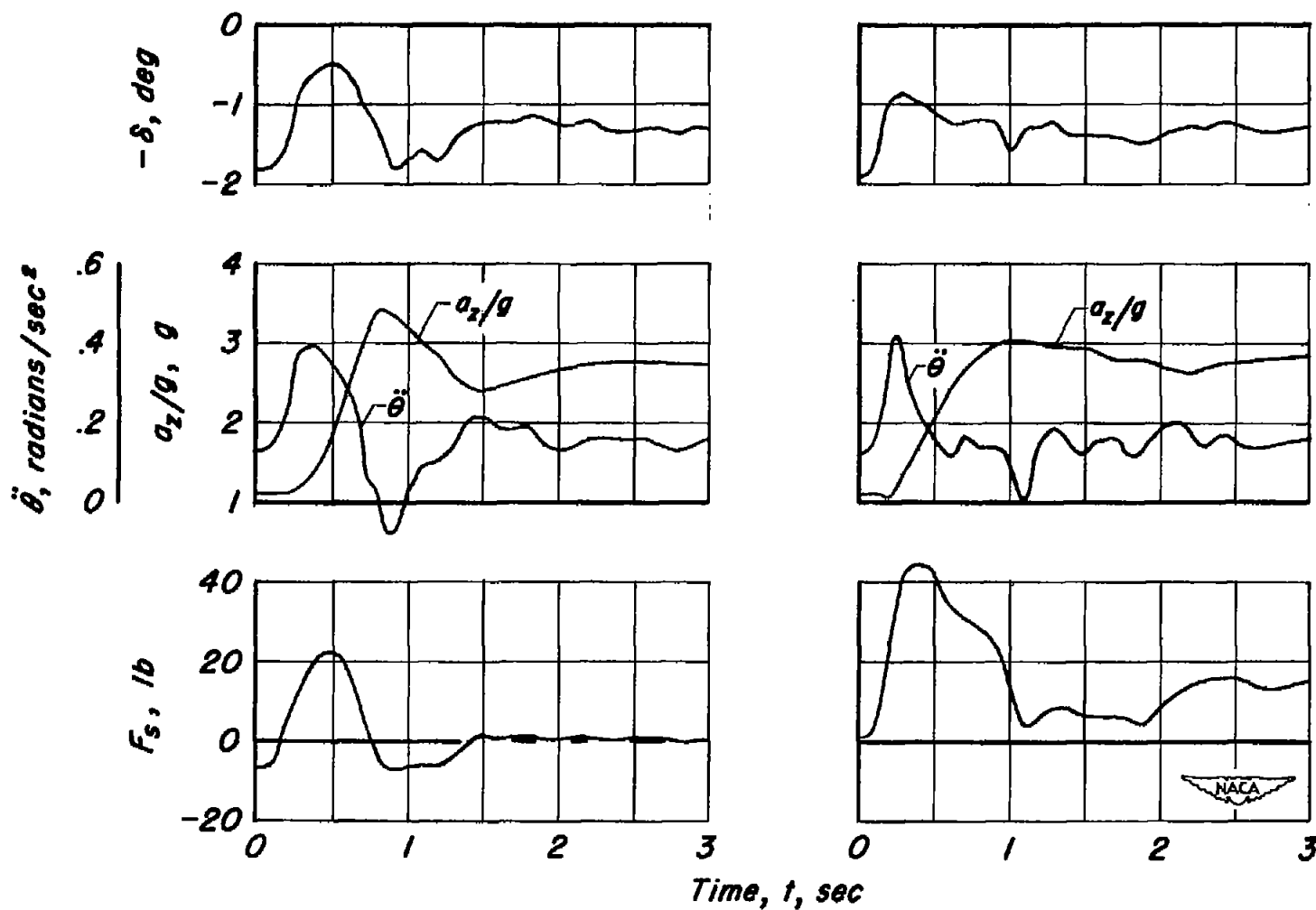

Figure 8.- Calculated variation of airplane pitching lead term T_0 with speed and altitude.



(a) Servo off.

(b) Servo on. $T = 0.4, K = 110$

Figure 9.- Time histories of rapid pull-ups at an altitude of 10,000 feet and an indicated air-speed of 350 mph.

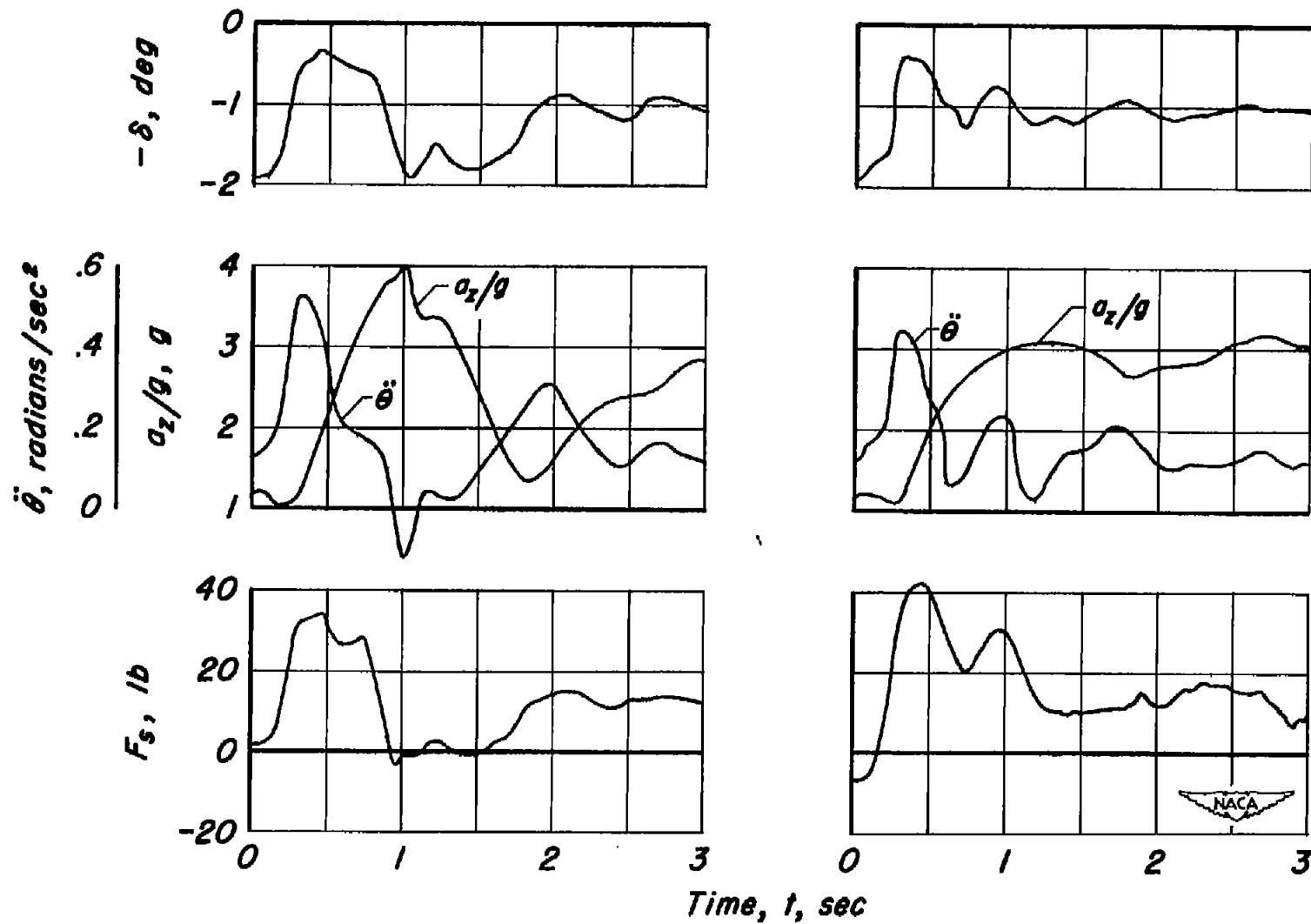

(a) Servo off.

(b) Servo on. $T = 0.9$, $K = 180$

Figure 10.- Time histories of rapid pull-ups at an altitude of 10,000 feet and an indicated air-speed of 350 mph in rough air.

SECURITY INFORMATION



3 1176 01434 8073

11/11/11

[REDACTED]

[REDACTED]