

# NATIONAL ADVISORY COMMITTEE FOR AERONAUTICS

TECHNICAL NOTE 2798

AN EXPERIMENTAL INVESTIGATION OF THE BEHAVIOR OF  
24S-T4 ALUMINUM ALLOY SUBJECTED TO  
REPEATED STRESSES OF CONSTANT AND  
VARYING AMPLITUDES

By Herbert F. Hardrath and Elmer C. Utley, Jr.

Langley Aeronautical Laboratory  
Langley Field, Va.



Washington  
October 1952

## TECHNICAL NOTE 2798

AN EXPERIMENTAL INVESTIGATION OF THE BEHAVIOR OF  
24S-T4 ALUMINUM ALLOY SUBJECTED TO  
REPEATED STRESSES OF CONSTANT AND  
VARYING AMPLITUDES

By Herbert F. Hardrath and Elmer C. Utley, Jr.

## SUMMARY

A device for adapting R. R. Moore rotating-beam fatigue testing machines for tests in which the amplitude of stress is continuously varied is described. Tests of 24S-T4 aluminum-alloy specimens subjected to stresses of constant amplitude and to stresses with amplitudes varying according to sinusoidal and exponential functions are reported. The results are analyzed by computing the summation of cycle ratios. The values obtained in this analysis were found to be influenced by the shape of the frequency-distribution curve.

## INTRODUCTION

A given part of an aircraft structure may be subjected to irregular stresses as a result of engine vibrations, gusts, maneuvers, and landings. Prediction of the life expectancy of such a part involves knowledge of the cumulative effect of successive applications of stresses which vary in amplitude.

Numerous investigators have performed tests in which the effects of varying the amplitude of stress were studied. Usually only two or three stress levels were used. Such simple loading sequences are rarely encountered in service. Few data have been accumulated for more complicated loading sequences and virtually no information regarding scatter in test results is available.

In order to gain a better background upon which to base cumulative-damage criterions and to provide information regarding scatter in tests involving stresses of varying amplitude, an experimental investigation was carried out in which 24S-T4 rotating-beam specimens were tested under constant and under continuously varying amplitudes of stress. The data and a simple analysis are presented.

## PREPARATION OF SPECIMENS

All test specimens were taken from 40 lengths of 24S-T4 aluminum-alloy extruded bar stock 1/2 inch in diameter. One tensile test specimen and one compressive test specimen were cut from surplus material at each end of each rod. Cylindrical tensile specimens with 0.3 inch diameter were prepared according to reference 1. Compressive test specimens were  $1\frac{1}{2}$  inches long with ends ground parallel and normal to the axis; the cylindrical surfaces were left as received.

Thirty fatigue-test specimen blanks  $3\frac{3}{4}$  inches long were cut from each rod and marked in the following sequence: A1, B1, C1, D1, E1, A2, B2, . . . C6, D6, E6. Each specimen was further identified with the rod from which it was cut by a number which precedes these designations.

The shape and dimensions of the machined rotating-beam specimens are shown in figure 1. Three finishing cuts were taken in machining the reduced section of each specimen to minimize work-hardening. First the specimen was mounted on centers in a duplicator lathe and machined until the minimum diameter was  $0.315 \pm 0.003$ . The next cut removed approximately 0.010 inch from the diameter and the final cut removed not more than 0.002 inch from the diameter. Machine errors were corrected by repeating the last finishing cut one or more times. Approximately 0.003 inch was removed from the diameter by polishing. The final specimen diameters varied between 0.285 and 0.301 inch.

The specimens were superfinished in alternately longitudinal and circumferential directions until all marks left by the last preceding step were removed. During the longitudinal polishing steps the specimen was rotated at 25 rpm while the oscillating head traveled through a  $\frac{3}{16}$ -inch stroke at 450 cycles per minute. The relative motion between the polishing head and the surface of the specimen was approximately  $4^\circ$  to the axis. During the circumferential polishing steps the specimen was rotated at 100 rpm while the polishing head was stationary. In all steps the polishing medium was supported against the specimen with a force of 2 pounds by means of the hydraulic loading system. A neutral mineral oil was poured over the specimen in all polishing steps. The following polishing agents were used in the indicated order:

- (1) Formed stone, 600 grit, longitudinal direction
- (2) Metallographic emery paper, grit 2/0 backed with wool felt, circumferential direction
- (3) Metallographic emery paper, grit 4/0 backed with wool felt, longitudinal direction

(4) Chromic oxide with particle size of 0.5 micron made into paste form by mixing with distilled water and applied on metallographic polishing broadcloth, circumferential direction

(5) Chromic oxide with particle size of 0.5 micron made into paste form by mixing with distilled water and applied on metallographic polishing broadcloth, longitudinal direction

This technique readily produced a uniform surface which was expected to be relatively free of work-hardening. Each specimen was carefully examined under a 25 power microscope. Specimens were discarded whose surfaces displayed circumferential scratches, deep longitudinal scratches, pits, or any irregularity which might produce a stress concentration. Surface profile measurements made with a Brush Surface Analyzer showed the surface finishes to be 2 to 4 microinches rms.

The diameter of each specimen was carefully measured by means of an optical micrometer with an accuracy such that any reading could easily be duplicated to within 0.0002 inch.

#### TESTING MACHINES

All fatigue tests were performed in R. R. Moore rotating-beam fatigue-testing machines. The mechanism shown in figure 2 was designed and built to adapt these machines for tests in which the amplitude of stress is varied according to a predetermined schedule. In this device the load applied to the rotating beam is supplied by a calibrated spring, S, which is stretched by a cam-actuated lever, B. The pivot point, P, of the lever can be adjusted to produce several values of extension in the spring for a given displacement at the cam. The cam, C, is driven by a motor and gear-train combination. The extension of the spring is indicated by the dial gage, G, to permit measurement of the applied load. An initial load can be introduced into the system by adjusting the turnbuckle, T. The weight of the bearing housings contributes to the effective load on the rotating beam and thus produces a minimum stress amplitude in the specimen. Counterweights, W, were attached to the bearing housings to reduce this minimum stress amplitude.

In these tests the cams were rotated at 1 rpm and the specimens were rotated at 10,000 rpm to produce the stress histories indicated in figure 3. Two cams were used: Cam A produced stress amplitudes which varied sinusoidally with time; cam B produced stress amplitudes which varied according to an exponential function for most of its travel. Departure from this exponential function of cam B occurred at high

stresses since a follower with a  $\frac{1}{2}$ -inch radius was used in the lever. This follower had the effect of rounding-off the sharp point in the cam.

#### TESTS

Tensile and compressive tests were performed to obtain stress-strain curves for 80 standard cylindrical tensile specimens and for 20 cylindrical compressive specimens. Strains for the tensile tests were measured with electromagnetic extensometers with 1-inch gage lengths, and for the compressive tests, with Tuckerman optical strain gages with  $\frac{1}{2}$ -inch gage lengths.

Constant-amplitude fatigue tests were performed on 100 specimens to establish the basic S-N curve for the material. Ten specimens were tested at each of six stress levels and twenty specimens at each of two other stress levels. The additional specimens at these two stress levels were used for check tests which were made on the superfinishing technique periodically throughout the test program to insure uniformity in the surface finish.

Tests were performed in which specimens were subjected to stresses that varied continuously between two predetermined limits to develop stress histories of the types shown in figure 3. The stress amplitudes fluctuated from a minimum to a maximum and back to the lower value once during 10,000 revolutions of the specimen. Each test was begun with the specimen subjected to the minimum stress amplitude. The tests were conducted by varying two parameters: (1) the minimum stress to which the specimen was subjected, and (2) the stress range, defined as the difference between the minimum and maximum stress amplitudes to which the specimen was subjected. The test program was composed of tests conducted under 13 combinations of minimum stress values and nominal stress ranges for each of the two stress patterns.

The stress ranges for individual specimens differed somewhat from the nominal values since specimen diameters differed by  $\pm 0.008$  inch from the mean and the variation in load produced by the loading device for each test condition was fixed. A group of 10 specimens was tested under each of the loading conditions with equal minimum stresses for each specimen within the group.

The frequency distribution of cam A was symmetrical about the midpoint of the stress range; the frequency distribution of cam B was unsymmetrical and produced approximately 6 times as many stress cycles in the lower half of the stress range as in the upper half.

## DISCUSSION OF RESULTS

The results of the tensile and compressive tests are given in table 1. The data from these tests show good agreement with standard values with the exception of material from rods 9, 19, and 21 which had low mechanical properties. Test results are also given which exclude the tests of material from rods 9, 19, and 21. The fatigue-test results of specimens from these three rods indicate that their fatigue lives did not differ consistently from lives obtained for specimens taken from other rods.

The data from individual constant-amplitude fatigue tests are presented in table 2. The S-N curve determined by these tests is plotted in figure 4. The plotted points represent the arithmetic means of fatigue lives and ticks indicate the minimum and maximum lives at each stress level. The dotted curve was plotted from data given in reference 2 for rotating-beam fatigue tests on 24S-T4. The agreement between the curves is seen to be excellent, and the scatter does not seem greater than might be expected when ten specimens are tested at each stress level.

The data from individual tests under stresses of variable amplitude are presented in table 3. The last column of table 3 presents an analysis of these data according to the frequently used summation of cycle ratios. The symbol  $\sum \frac{n}{N}$ , where  $n$  is the number of cycles applied at a given stress level and  $N$  is the number of cycles to failure at this stress level, is used in the following discussion to represent this sum. In the analysis of these data the number of cycles in the total frequency-distribution spectrum for each specimen was divided into 12 equal parts and  $\sum \frac{n}{N}$  was computed on the assumption that all stresses in each part were applied at the midpoint of each of the corresponding stress intervals. Sample calculations for typical tests with each cam are given in table 4.

The values of  $\sum \frac{n}{N}$  are plotted against the minimum stress amplitude in figure 5. The symbols represent the arithmetic means of 10 values and the ticks represent the maximum and minimum values. The horizontal dotted line represents the prediction according to a hypothesis proposed by Miner (ref. 3) which states that failure will occur when  $\sum \frac{n}{N} = 1$ .

The scatter of values of  $\sum \frac{n}{N}$  for each stress condition and the variation of mean values precludes the establishment of definite

conclusions on the basis of these tests. The scatter, however, does not appear to be much greater than that observed in the constant-amplitude tests. Specimens tested with a minimum stress amplitude of 25 ksi, a stress range of 6 ksi, and cam A exhibited the greatest scatter. These tests were repeated with no significant difference in results. (See table 3.) In an attempt to reduce the scatter in results

the  $\sum \frac{n}{N}$  was recalculated for the specimen with the shortest life in each group with the lower limit of the scatter in the S-N data of figure 4 as a basis. Similarly, the specimen with the longest life was compared with the upper limit of the scatter band of figure 4. The results of these calculations are plotted in figure 6 together with the mean values previously used in figure 5. The scatter in  $\sum \frac{n}{N}$  values is seen to be reduced appreciably.

Other calculations of  $\sum \frac{n}{N}$  for representative specimens in each group were made with 20 equal increments of stress instead of equal increments of life. The results were not significantly different.

Point-by-point comparison between  $\sum \frac{n}{N}$  values for tests at a given value of minimum stress and stress range and for each of the two cams reveals that in all but two cases (i.e., stress range, 6 ksi; minimum stress, 20 ksi and 23 ksi) the  $\sum \frac{n}{N}$  value for cam A is larger than for cam B. The over-all average value of  $\sum \frac{n}{N}$  is 0.92 for cam A and 0.62 for cam B. Although these values must be regarded as qualitative rather than quantitative, they support the conclusion obtained from the point-by-point comparison that the value of  $\sum \frac{n}{N}$  for tests in which the amplitude of stress varied was influenced by the shape of the frequency-distribution curve.

#### CONCLUDING REMARKS

Rotating-beam fatigue tests were performed on unnotched 24S-T4 aluminum-alloy specimens. The results of a minimum of 10 tests at each of eight stress levels produced an average S-N curve which agreed well with data given in ANC-5.

Other tests were performed in which the amplitude of stress was continuously varied according to a sinusoidal or an exponential law. Ten nominally identical tests were performed under each of 26 conditions. The scatter in results of these tests was found to be approximately as much as the scatter in results of constant-amplitude tests. The data were analyzed by computing the summation of cycle ratios

$\sum \frac{n}{N}$  with the result that tests in which the stress amplitude is varied sinusoidally produced values of  $\sum \frac{n}{N}$  higher than those produced in tests in which the stress amplitude was varied according to the exponential function. The average of all values of  $\sum \frac{n}{N}$  produced in tests where the stress varied sinusoidally was 0.92, and in tests where the stress varied exponentially it was 0.62. It appears, then, that the value of  $\sum \frac{n}{N}$  at failure was influenced by the shape of the frequency-distribution curve.

Langley Aeronautical Laboratory,  
National Advisory Committee for Aeronautics,  
Langley Field, Va., July 16, 1952.

#### REFERENCES

1. Anon.: Standard Methods of Tension Testing of Metallic Materials. A.S.T.M. Designation: E 8-46. Pt. 1 of 1949 Book of A.S.T.M. Standards Including Tentatives. A.S.T.M. (Philadelphia), 1950, pp. 1233-1244.
2. Anon.: Strength of Metal Aircraft Elements. ANC-5, Munitions Board Aircraft Committee, Dept. of Defense. Revised ed., June 1951.
3. Miner, Milton A.: Cumulative Damage in Fatigue. Jour. Appl. Mech., vol. 12, no. 3, Sept. 1945, pp. A-159 - A-164.



TABLE 1.- RESULTS OF TENSILE AND COMPRESSIVE  
TESTS ON 24S-T4 EXTRUDED ROD

	Tensile (80 Tests)	Compressive (20 Tests)
Yield stress, ksi:		
Minimum . . . . .	37.60	42.70
Average . . . . .	51.86	56.18
Maximum . . . . .	55.20	63.60
Yield stress excluding rods 9, 19, and 21, ksi:		
Minimum . . . . .	49.30	58.60
Average . . . . .	52.65	60.56
Young's modulus, E, ksi:		
Minimum . . . . .	$10.05 \times 10^3$	$10.58 \times 10^3$
Average . . . . .	$10.39 \times 10^3$	$10.78 \times 10^3$
Maximum . . . . .	$10.70 \times 10^3$	$11.00 \times 10^3$
Ultimate stress, ksi:		
Minimum . . . . .	56.60	-----
Average . . . . .	71.19	-----
Maximum . . . . .	74.50	-----
Ultimate stress excluding rods 9, 19, and 21, ksi:		
Minimum . . . . .	69.60	-----
Average . . . . .	71.96	-----
Elongation, percent		
Minimum . . . . .	11.5	-----
Average . . . . .	12.2	-----
Maximum . . . . .	12.8	-----

TABLE 2.- RESULTS OF CONSTANT-AMPLITUDE ROTATING-BEAM  
FATIGUE TESTS OF 24S-T4 ALUMINUM ALLOY

Specimen	Cycles to failure	Specimen	Cycles to failure
S = 50 ksi		S = 40 ksi	
39B3	28,000	24A4	171,000
34A4	26,000	23A4	163,000
35A4	24,000	28A4	161,000
37A4	22,000	22A4	159,000
23B3	20,000	25A4	146,000
6B2	20,000	9B2	141,000
36A4	18,000	27A1	135,000
30B3	18,000	27A4	121,000
21B3	18,000	26A4	114,000
21B2	15,000	4B2	89,000
Average:	20,900	Average:	140,000
S = 30 ksi		S = 25 ksi	
23A3	4,700,000	39A2	17,528,000
15A3	2,242,000	24A2	12,493,000
24A3	1,796,000	27A2	11,864,000
11A3	1,792,000	31C4	8,239,000
9A3	1,726,000	35A2	8,236,000
12A3	1,693,000	29A2	7,576,000
18A3	1,595,000	29C4	7,422,000
10A3	1,510,000	30C4	7,331,000
35C6	1,474,000	33C4	6,957,000
19A3	1,370,000	32A2	6,521,000
13A3	1,349,000	34C4	6,257,000
22A3	1,220,000	28A2	5,343,000
14A3	1,190,000	22A2	5,170,000
20A3	1,187,000	39C4	5,093,000
16A3	886,000	25A2	4,801,000
23C6	792,000	40C4	4,570,000
21A3	786,000	26D6	4,130,000
37C4	776,000	21A2	4,013,000
17A3	699,000	32C4	3,993,000
38C4	393,000	35D6	2,292,000
Average:	1,459,000	Average:	6,991,450

TABLE 2.- RESULTS OF CONSTANT-AMPLITUDE ROTATING-BEAM  
FATIGUE TESTS OF 24S-T4 ALUMINUM ALLOY - Concluded

Specimen	Cycles to failure	Specimen	Cycles to failure
S = 27 ksi		S = 22 ksi	
31A4	4,223,000	23A2	50,278,000
22A5	4,162,000	37A2	29,890,000
30A4	3,650,000	38A2	23,178,000
28A1	3,098,000	34A2	22,119,000
32A4	2,882,000	26A2	17,867,000
23A1	2,766,000	40A2	16,536,000
24A5	2,706,000	36A2	13,631,000
21A5	2,482,000	31A2	13,206,000
33A4	2,464,000	33A2	13,093,000
23A5	2,224,000	21A6	12,090,000
Average:	3,065,000	Average:	21,189,000
S = 20 ksi		S = 19 ksi	
35A6	317,912,000	15D2	<sup>a</sup> 602,000,000
38A6	270,169,000	9D3	<sup>a</sup> 598,847,000
25A6	118,000,000	3D2	<sup>a</sup> 598,847,000
30A6	117,843,000	1D2	516,414,000
23A6	106,542,000	8D2	489,637,000
22A6	100,725,000	6D2	247,310,000
40A6	90,265,000	5D2	183,979,000
28A6	89,681,000	30B5	91,034,000
29A6	63,674,000	7D2	53,962,000
34A6	33,740,000	21B5	47,425,000
26A6	19,082,000		
Average:	120,694,000	Average of specimens that failed:	
		232,823,000	

<sup>a</sup>Specimen did not fail.



TABLE 3.- RESULTS OF VARYING-AMPLITUDE ROTATING-BEAM

FATIGUE TESTS OF 24S-T4 ALUMINUM ALLOY

[Cam A, sinusoidal variation; cam B, exponential variation of stress amplitudes]

Cam A				Cam B			
Specimen	S <sub>max</sub> , ksi	Cycles to failure	$\sum \frac{n}{N}$	Specimen	S <sub>max</sub> , ksi	Cycles to failure	$\sum \frac{n}{N}$
S <sub>min</sub> = 17 ksi; S <sub>range</sub> = 18 ksi				S <sub>min</sub> = 17 ksi; S <sub>range</sub> = 18 ksi			
13D1	36.3	2,616,000	2.45	19D1	35.9	4,972,000	0.85
1D1	35.0	2,002,000	1.41	10D2	38.8	3,835,000	1.06
16D1	33.5	1,258,000	.64	10D1	39.1	3,139,000	.95
18D1	34.8	1,167,000	.79	8D1	39.0	2,709,000	.81
25D3	36.5	1,032,000	1.01	6D1	38.7	2,467,000	.70
9D2	37.2	606,000	.68	3D1	38.8	2,225,000	.60
7D1	37.1	523,000	.62	14D1	37.7	1,555,000	.37
4D1	37.4	483,000	.57	2D1	39.1	1,544,000	.47
9D1	37.2	445,000	.50	17D1	35.1	1,505,000	.21
21D3	36.5	425,000	.41	26D3	37.9	1,304,000	.38
11D1	36.8	377,000	.39	22D3	37.7	1,158,000	.21
Average:			994,000 0.86	Average:			2,401,000 0.59
S <sub>min</sub> = 18 ksi; S <sub>range</sub> = 6 ksi				S <sub>min</sub> = 18 ksi; S <sub>range</sub> = 6 ksi			
35D3	24.5	24,574,000	1.09	34D3	24.0	64,429,000	0.79
26D2	24.6	24,456,000	1.13	22D5	24.4	56,163,000	.71
31D3	24.5	23,186,000	1.03	35D5	24.5	47,717,000	.65
22C1	24.6	19,670,000	.91	21C1	24.2	40,983,000	.50
21D5	24.5	19,260,000	.86	32D3	24.6	39,360,000	.55
29C1	23.9	12,231,000	.44	37D3	24.1	35,247,000	.39
33D3	24.1	9,014,000	.35	34D2	24.4	28,510,000	.36
33D2	24.2	6,594,000	.26	23C1	24.5	22,354,000	.30
34D5	24.1	5,200,000	.20	27D2	24.7	18,783,000	.27
40D2	24.0	3,312,000	.12	36D3	24.4	18,540,000	.23
Average:			14,750,000 0.64	Average:			37,208,000 0.42



TABLE 3.- RESULTS OF VARYING-AMPLITUDE ROTATING-BEAM

FATIGUE TESTS OF 24S-T4 ALUMINUM ALLOY - Continued

[Cam A, sinusoidal variation; cam B, exponential  
variation of stress amplitudes]

Cam A				Cam B			
Specimen	$S_{max}$ , ksi	Cycles to failure	$\sum \frac{n}{N}$	Specimen	$S_{max}$ , ksi	Cycles to failure	$\sum \frac{n}{N}$
$S_{min} = 18$ ksi; $S_{range} = 12$ ksi				$S_{min} = 18$ ksi; $S_{range} = 12$ ksi			
30C1	31.1	6,787,000	2.02	31C1	31.2	5,864,000	0.44
38C1	30.8	4,666,000	1.30	21C4	30.6	5,656,000	.37
23C4	28.8	4,026,000	.65	24D6	30.6	5,614,000	.37
34C1	31.2	3,302,000	1.01	39C1	31.5	5,447,000	.42
26C4	30.8	3,138,000	.87	33C1	30.5	5,338,000	.34
35C4	28.9	2,879,000	.47	35C1	31.3	4,664,000	.36
22C3	31.2	2,028,000	.62	25C4	31.3	4,334,000	.33
40C1	28.7	1,704,000	.26	36C4	30.6	3,903,000	.25
36C1	29.6	1,330,000	.27	24C4	30.4	3,442,000	.22
32C1	30.0	597,000	.14	8D3	31.7	2,668,000	.22
Average:		3,046,000	0.66	Average:		4,693,000	0.33
$S_{min} = 18$ ksi; $S_{range} = 18$ ksi				$S_{min} = 18$ ksi; $S_{range} = 18$ ksi			
30D4	37.5	1,437,000	1.78	33D4	36.8	3,292,000	0.72
36D4	35.7	1,114,000	.94	25D4	37.1	2,899,000	.66
26D4	37.8	1,110,000	1.46	29D4	37.0	2,569,000	.58
38D4	38.4	1,069,000	1.58	24D3	37.1	2,248,000	.51
34D4	37.3	1,056,000	1.25	23D4	38.6	2,061,000	.54
24D4	35.7	885,000	.75	37D4	37.0	2,021,000	.49
23D3	35.8	782,000	.68	27D4	38.7	1,806,000	.57
32D4	35.6	689,000	.57	35D4	38.7	1,451,000	.46
28D4	35.6	652,000	.54	31D4	38.8	1,156,000	.36
22D4	37.8	334,000	.44	39D4	39.5	876,000	.30
Average:		913,000	1.00	Average:		2,038,000	0.52

TABLE 3.— RESULTS OF VARYING-AMPLITUDE ROTATING-BEAM

FATIGUE TESTS OF 24S-T4 ALUMINUM ALLOY - Continued

[Cam A, sinusoidal variation; cam B, exponential variation of stress amplitudes]

Cam A				Cam B			
Specimen	S <sub>max</sub> , ksi	Cycles to failure	$\sum \frac{n}{N}$	Specimen	S <sub>max</sub> , ksi	Cycles to failure	$\sum \frac{n}{N}$
S <sub>min</sub> = 20 ksi; S <sub>range</sub> = 6 ksi				S <sub>min</sub> = 20 ksi; S <sub>range</sub> = 6 ksi			
19B3	26.9	13,731,000	1.59	9B5	25.5	30,764,000	1.14
18B2	26.9	7,684,000	.89	7E2	26.0	28,810,000	1.17
8E5	26.0	5,920,000	.53	12B5	26.5	21,517,000	.97
14B4	26.9	5,830,000	.68	16B5	26.8	15,438,000	.73
20B3	26.8	2,632,000	.29	1B5	26.0	14,090,000	.57
15B2	26.2	2,057,000	.19	39A5	26.4	7,246,000	.32
1B2	26.2	1,555,000	.15	38A5	26.5	6,785,000	.30
10B3	26.7	1,389,000	.15	7B5	27.2	6,092,000	.31
14B3	25.7	1,360,000	.11	13B5	27.6	3,832,000	.21
9B4	26.2	1,190,000	.11	12A5	26.8	3,560,000	.17
Average:		4,334,000	0.47	Average:		13,813,000	0.59
S <sub>min</sub> = 20 ksi; S <sub>range</sub> = 12 ksi				S <sub>min</sub> = 20 ksi; S <sub>range</sub> = 12 ksi			
33A1	32.7	5,343,000	2.60	25A3	33.5	11,716,000	1.89
34A5	31.8	4,226,000	1.66	14A5	32.4	9,870,000	1.31
19A5	32.0	3,610,000	1.48	11A5	36.7	8,118,000	2.24
18A5	31.8	2,828,000	1.11	20A5	32.5	7,605,000	1.03
37A6	33.0	2,599,000	1.35	28A5	33.5	5,208,000	.84
17A5	32.5	2,599,000	1.21	36A5	34.0	4,545,000	.79
33A6	33.4	2,100,000	1.18	30A1	33.3	3,628,000	.57
27A6	32.3	1,997,000	.88	16A5	35.2	3,121,000	.52
30A5	32.7	1,673,000	.81	31A6	32.7	3,092,000	.43
32A6	33.1	1,526,000	.80	24A6	34.9	1,778,000	.36
Average:		2,850,000	1.24	Average:		5,868,000	1.00

TABLE 3.- RESULTS OF VARYING-AMPLITUDE ROTATING-BEAM

FATIGUE TESTS OF 24S-T4 ALUMINUM ALLOY - Continued

[Cam A, sinusoidal variation; cam B, exponential  
variation of stress amplitudes]

Cam A				Cam B			
Specimen	$S_{max}$ , ksi	Cycles to failure	$\sum \frac{n}{N}$	Specimen	$S_{max}$ , ksi	Cycles to failure	$\sum \frac{n}{N}$
$S_{min} = 23$ ksi; $S_{range} = 6$ ksi				$S_{min} = 23$ ksi; $S_{range} = 6$ ksi			
37C3	30.2	2,481,000	0.85	32D6	28.9	10,114,000	1.40
11D4	29.8	1,941,000	.60	18D4	29.7	8,076,000	1.25
11D2	30.4	1,771,000	.63	28D6	29.2	7,680,000	1.12
15D4	29.7	1,563,000	.48	7D4	29.6	6,882,000	1.06
3D4	29.5	1,465,000	.43	9D4	29.7	6,210,000	.96
14D6	29.6	1,152,000	.34	10D4	30.0	5,592,000	.90
4D4	29.6	1,084,000	.31	2D3	29.8	5,466,000	.84
24C3	29.5	988,000	.29	40C3	29.4	5,231,000	.78
38C3	29.9	714,000	.23	20D4	29.6	4,124,000	.63
22C3	29.8	643,000	.20	39C3	29.4	1,924,000	.29
Average: 1,380,000 0.43				Average: 6,130,000 0.92			
$S_{min} = 25$ ksi; $S_{range} = 6$ ksi				$S_{min} = 25$ ksi; $S_{range} = 6$ ksi			
28B6	31.4	5,776,000	2.98	27B6	32.2	4,097,000	1.31
39B6	32.2	4,371,000	2.64	36B6	32.3	2,679,000	.87
30C6	31.8	4,260,000	2.38	23B6	32.2	2,197,000	.70
39C6	31.8	3,441,000	1.92	30B6	31.2	1,879,000	.56
24B6	30.9	2,414,000	1.12	32C6	31.6	1,801,000	.54
33C6	31.2	2,041,000	1.02	38E5	31.8	1,497,000	.46
31C6	31.0	1,224,000	.58	38C6	31.7	1,442,000	.43
29B6	31.7	833,000	.46	25B6	32.2	1,302,000	.41
21B6	31.4	740,000	.38	40B6	31.6	1,255,000	.38
36B2	31.2	481,000	.24	36B1	31.4	541,000	.16
Average: 2,558,000 1.37				Average: 1,869,000 0.58			

TABLE 3.- RESULTS OF VARYING-AMPLITUDE ROTATING-BEAM

FATIGUE TESTS OF 24S-T4 ALUMINUM ALLOY - Continued

[Cam A, sinusoidal variation; cam B, exponential variation of stress amplitudes]

Cam A				Cam B			
Specimen	S <sub>max</sub> , ksi	Cycles to failure	$\sum \frac{n}{N}$	Specimen	S <sub>max</sub> , ksi	Cycles to failure	$\sum \frac{n}{N}$
S <sub>min</sub> = 25 ksi; S <sub>range</sub> = 12 ksi				S <sub>min</sub> = 25 ksi; S <sub>range</sub> = 12 ksi			
13B6	38.3	1,224,000	2.33	11B6	38.1	2,403,000	1.57
40A1	37.3	899,000	1.43	38A1	37.5	2,340,000	1.43
37A1	37.5	846,000	1.40	37A5	39.2	2,316,000	1.74
39A1	38.8	840,000	1.76	12B6	39.5	1,051,000	.83
26A5	38.7	835,000	1.72	10B6	37.5	1,049,000	.64
35A5	38.3	745,000	1.48	18B6	38.7	1,035,000	.73
40A5	36.1	734,000	.94	29A1	36.9	932,000	.53
31A5	39.4	650,000	1.51	27A5	40.0	928,000	.77
32A5	37.5	597,000	.99	36A1	35.9	860,000	.43
15B6	37.4	317,000	.52	34A1	37.8	772,000	.49
Average:			769,000 1.41	Average:			1,368,000 0.92
S <sub>min</sub> = 27 ksi; S <sub>range</sub> = 6 ksi				S <sub>min</sub> = 27 ksi; S <sub>range</sub> = 6 ksi			
22B3	33.4	1,483,000	1.33	20B4	33.3	2,505,000	1.33
37B2	33.7	1,161,000	1.09	9B1	33.6	1,943,000	1.06
24B3	34.0	1,074,000	1.06	4B1	33.4	1,133,000	.61
37B3	33.9	1,013,000	.99	14B1	33.6	1,057,000	.58
31B2	33.6	687,000	.63	3B5	33.7	996,000	.55
34B3	33.6	600,000	.56	20B1	33.4	842,000	.45
26B3	34.0	513,000	.51	11B1	34.4	824,000	.49
13B2	34.1	496,000	.50	1B1	34.3	667,000	.39
16B4	33.8	391,000	.37	13B1	34.6	665,000	.40
10B2	33.7	378,000	.35	2B1	34.0	606,000	.34
Average:			780,000 0.74	Average:			1,124,000 0.62





TABLE 3.- RESULTS OF VARYING-AMPLITUDE ROTATING-BEAM

FATIGUE TESTS OF 24S-T4 ALUMINUM ALLOY - Continued

[Cam A, sinusoidal variation; cam B, exponential  
variation of stress amplitudes]

Cam A				Cam B			
Specimen	S <sub>max</sub> , ksi	Cycles to failure	$\sum \frac{n}{N}$	Specimen	S <sub>max</sub> , ksi	Cycles to failure	$\sum \frac{n}{N}$
S <sub>min</sub> = 27 ksi; S <sub>range</sub> = 12 ksi				S <sub>min</sub> = 27 ksi; S <sub>range</sub> = 12 ksi			
20B6	39.7	698,000	1.88	17B3	41.4	659,000	0.84
31A1	40.9	505,000	1.67	17B4	40.0	468,000	.51
15B5	40.6	498,000	1.56	13B4	42.5	439,000	.63
5B5	40.6	383,000	1.20	12B3	41.2	391,000	.49
10B5	39.7	328,000	.88	8B4	41.3	368,000	.46
22A1	38.9	169,000	.40	11B4	39.6	328,000	.34
6B5	40.5	168,000	.51	13B3	39.8	306,000	.33
29A5	39.6	156,000	.41	2B4	41.5	258,000	.22
8B5	39.5	142,000	.37	16B3	40.0	252,000	.27
11B5	39.4	141,000	.36	16B2	40.2	217,000	.24
Average:		319,000	0.92	Average:		369,000	0.43
S <sub>min</sub> = 30 ksi; S <sub>range</sub> = 6 ksi				S <sub>min</sub> = 30 ksi; S <sub>range</sub> = 6 ksi			
26C6	36.4	704,000	1.40	32E4	35.4	838,000	0.93
24C6	36.8	651,000	1.32	7C5	37.2	811,000	1.04
28C6	36.3	587,000	1.09	2C5	36.8	516,000	.64
13C5	36.7	567,000	1.14	37C6	36.2	339,000	.46
12C5	36.7	543,000	1.09	34C6	36.8	317,000	.39
31C2	36.6	405,000	.80	38B6	37.1	275,000	.36
40C6	35.9	353,000	.60	32C2	36.0	263,000	.31
33C2	36.7	263,000	.53	34C2	37.9	259,000	.35
17C5	36.2	252,000	.46	29C6	36.4	225,000	.27
21C6	37.2	185,000	.40	32B6	37.4	210,000	.28
Average:		451,000	0.88	Average:		405,000	0.40

TABLE 3.- RESULTS OF VARYING-AMPLITUDE ROTATING-BEAM

FATIGUE TESTS OF 24S-T4 ALUMINUM ALLOY - Concluded

[Cam A, sinusoidal variation; cam B, exponential  
variation of stress amplitudes]

Cam A				Cam B			
Specimen	$S_{max}$ , ksi	Cycles to failure	$\sum \frac{n}{N}$	Specimen	$S_{max}$ , ksi	Cycles to failure	$\sum \frac{n}{N}$
$S_{min} = 30$ ksi; $S_{range} = 12$ ksi				$S_{min} = 30$ ksi; $S_{range} = 12$ ksi			
18B4	43.6	434,000	2.56	33B6	44.1	386,000	0.96
8B1	43.4	422,000	2.41	33B3	42.2	378,000	.78
3B1	42.9	320,000	1.70	8B2	43.3	323,000	.77
12B1	43.3	300,000	1.69	17B2	44.2	316,000	.79
16B1	42.7	272,000	1.40	29B3	43.3	276,000	.63
19B1	43.6	254,000	1.50	12B2	45.0	272,000	.74
20B5	42.1	138,000	.64	28B3	45.6	261,000	.76
5B1	42.5	120,000	.60	11B2	43.2	242,000	.55
10B1	42.6	113,000	.57	35B3	43.1	323,000	.50
15B4	42.4	110,000	.54	7B2	43.0	223,000	.50
Average:		248,000	1.36	Average:		300,000	0.70
$S_{min} = 25$ ksi; $S_{range} = 6$ ksi (a)							
1E5	29.9	6,758,000	2.62				
3E5	29.9	3,008,000	1.18				
22E5	33.5	2,235,000	1.74				
30E5	33.3	1,940,000	1.01				
25E5	33.3	1,915,000	1.44				
37E5	33.2	1,875,000	1.38				
27E5	30.4	1,845,000	.54				
1E2	30.3	1,592,000	.69				
40E2	33.0	969,000	.70				
36E5	30.2	938,000	.37				
Average:		2,307,000	1.17				

<sup>a</sup>Repeat tests to check scatter of data.

TABLE 4.- SAMPLE CALCULATIONS OF  $\sum \frac{n}{N}$  FOR A SPECIMEN SUBJECTED

TO STRESS OF VARYING AMPLITUDE

(a) SINUSOIDAL VARIATION, CAM A

[Specimen 40A5; minimum stress, 25 ksi; maximum stress, 36.1 ksi; life, 734,000 cycles]

Position of cam, deg	Stress factor, percent of range	Stress, ksi	Mean stress in increment, ksi	n	N	$\frac{n}{N}$
0	0	25.0	25.1	$0.0612 \times 10^6$	$6.3 \times 10^6$	0.00971
15	1.7	25.19	25.5	.0612	5.5	.01113
30	6.7	25.74	26.2	.0612	4.4	.01391
45	14.7	26.63	27.2	.0612	3.15	.01943
60	25.0	27.78	28.4	.0612	2.15	.02847
75	37.1	29.12	29.8	.0612	1.42	.04310
90	50.0	30.55	31.3	.0612	.97	.06309
105	63.0	32.10	32.7	.0612	.666	.09189
120	75.0	33.32	33.9	.0612	.509	.12024
135	85.4	34.46	34.9	.0612	.395	.15493
150	93.3	35.35	35.6	.0612	.34	.18000
165	98.3	35.90	36.00	.0612	.305	.20065
180	100	36.10				
$\sum \frac{n}{N} = 0.94$						



TABLE 4. - SAMPLE CALCULATIONS OF  $\sum \frac{n}{N}$  FOR A SPECIMEN SUBJECTED

TO STRESS OF VARYING AMPLITUDE - Concluded

(b) EXPONENTIAL VARIATION, CAM B

[Specimen 4B1; minimum stress, 27 ksi; maximum stress, 33.4 ksi; life, 1,133,000 cycles]

Position of cam, deg	Stress factor, percent of range	Stress, ksi	Mean stress in increment, ksi	n	N	$\frac{n}{N}$
0	0	27.00	27.05	$0.0944 \times 10^6$	$3.25 \times 10^6$	0.029046
15	2.2	27.14	27.20	.0944	3.15	.029968
30	4.8	27.31	27.40	.0944	2.9	.032552
45	7.2	27.46	27.6	.0944	2.75	.034327
60	10.4	27.67	27.80	.0944	2.58	.036589
75	13.6	27.87	28.00	.0944	2.45	.038531
90	17.8	28.14	28.30	.0944	2.20	.042909
105	22.4	28.43	28.6	.0944	2.05	.046049
120	28.2	28.80	29.0	.0944	1.81	.052155
135	35.4	29.26	29.6	.0944	1.52	.062105
150	45.8	29.93	30.5	.0944	1.20	.078667
165	63.8	31.08	32.2	.0944	.76	.124211
180	100	33.40				
$\sum \frac{n}{N} = 0.61$						



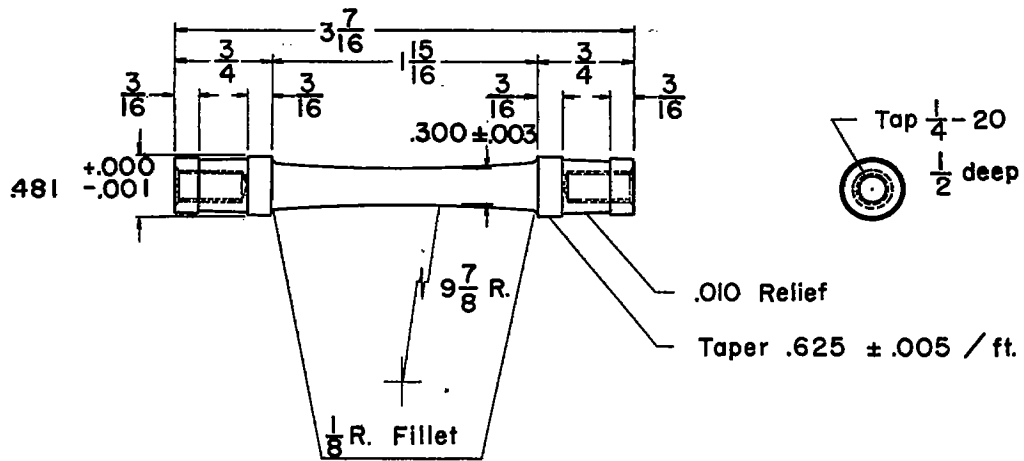

Figure 1.- Rotating-beam specimen.

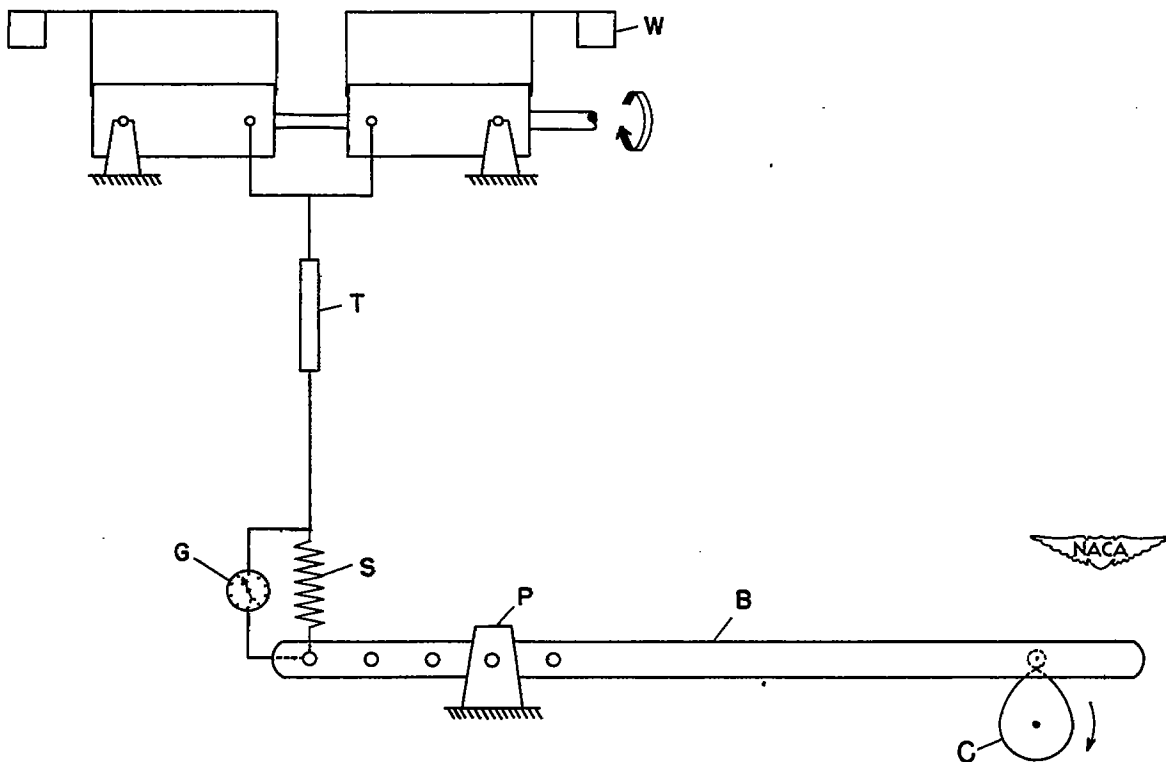

Figure 2.- Loading device for rotating-beam tests in which the amplitude varies continuously.

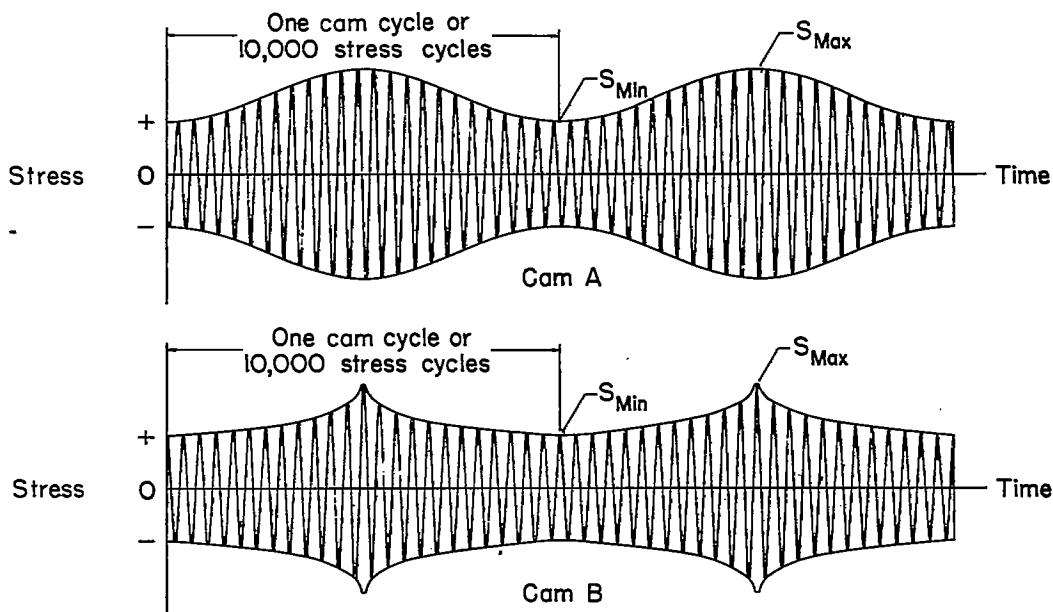

Figure 3.- Stress patterns for tests with variable stress amplitude.

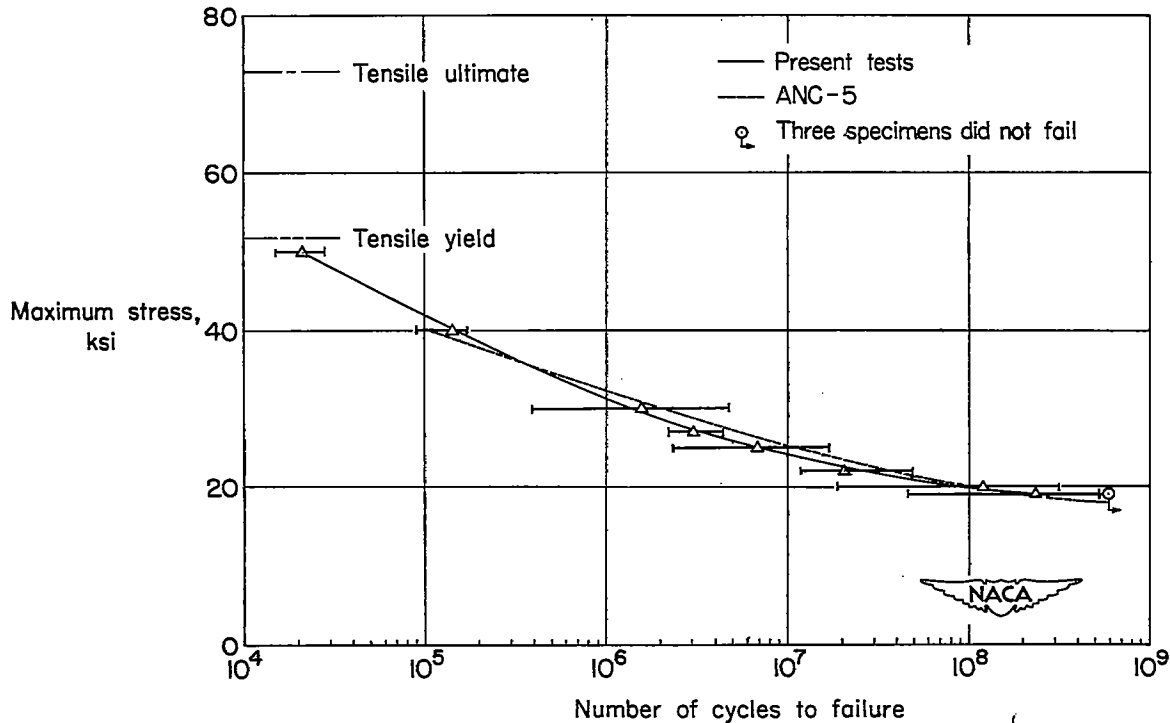

Figure 4.- S-N curves for tests of 24S-T4 rotating-beam specimens.

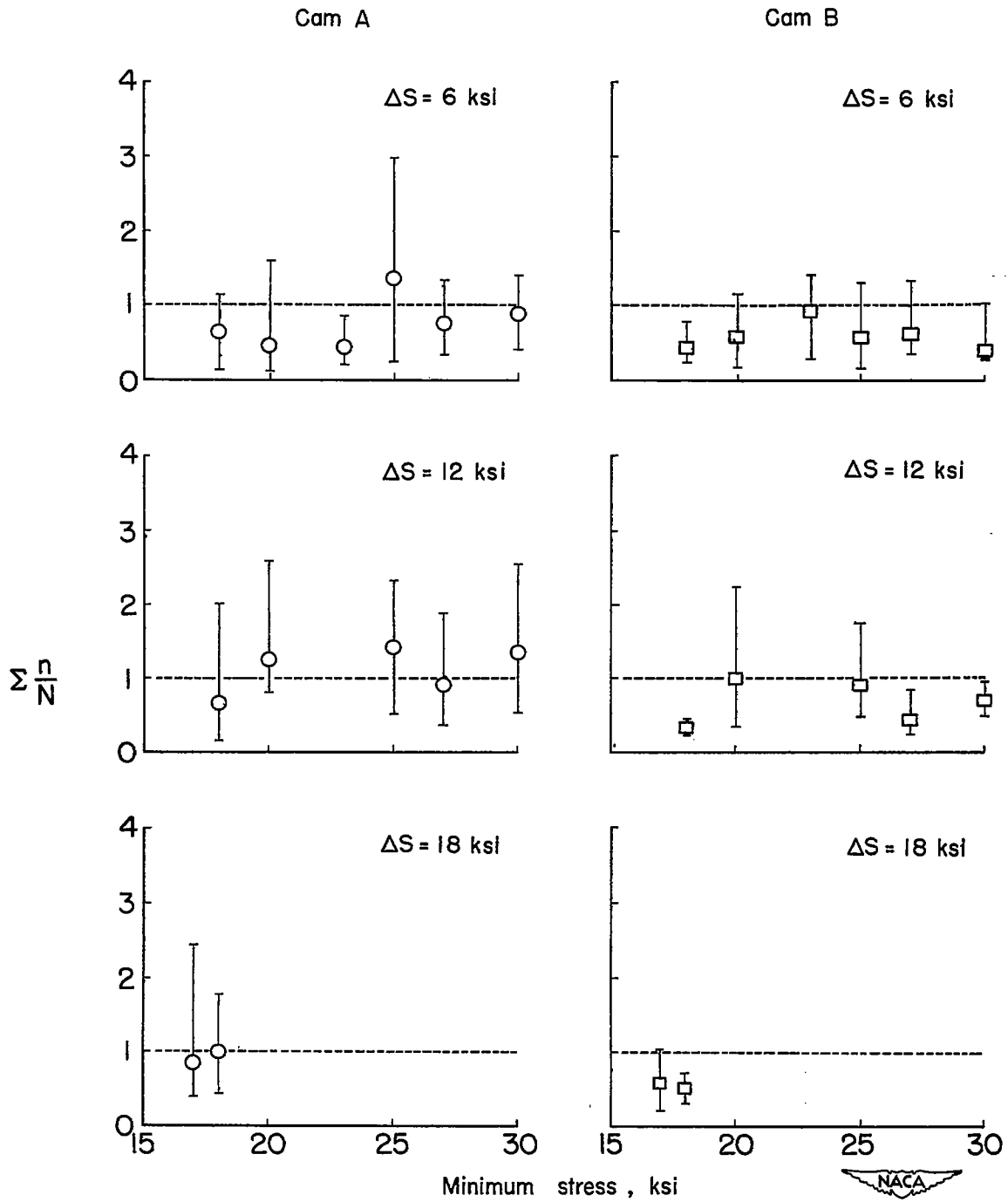

Figure 5.-  $\sum \frac{n}{N}$  for tests with variable stress amplitude.



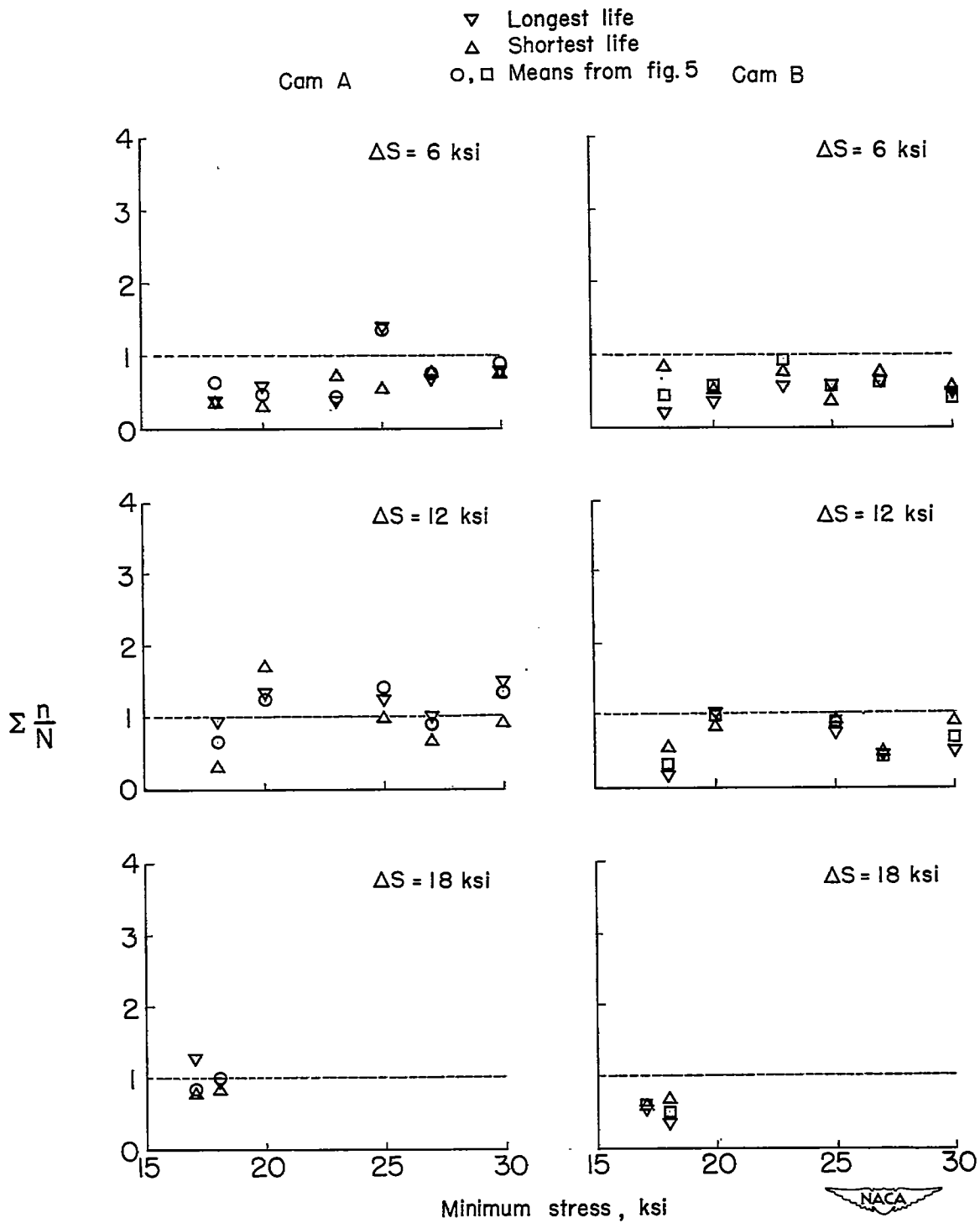

Figure 6.-  $\sum \frac{n}{N}$  computed for extreme values.