



NATIONAL ADVISORY COMMITTEE FOR AERONAUTICS

TECHNICAL NOTE 2762

AERODYNAMIC CHARACTERISTICS OF THREE DEEP-STEP PLANING-
TAIL FLYING-BOAT HULLS AND A TRANSVERSE-STEP HULL
WITH EXTENDED AFTERBODY

By John M. Riebe and Rodger L. Naeseth

Langley Aeronautical Laboratory
Langley Field, Va.



Washington

August 1952

AFMDC
TECHNICAL LIBRARY
AFL 2811



NATIONAL ADVISORY COMMITTEE FOR AERONAUTICS

TECHNICAL NOTE 2762

AERODYNAMIC CHARACTERISTICS OF THREE DEEP-STEP PLANING-
TAIL FLYING-BOAT HULLS AND A TRANSVERSE-STEP HULL
WITH EXTENDED AFTERBODY¹

By John M. Riebe and Rodger L. Naeseth

SUMMARY

An investigation was made to determine the aerodynamic characteristics in the presence of a wing of three deep-step planing-tail flying-boat hulls which differed only in the amount of step fairing. The hulls were derived by increasing the unfaired-step depth of a planing-tail hull of a previous aerodynamic investigation to a depth of about 92 percent of the hull beam. For the purpose of comparison, tests were also made of a transverse-step hull with an extended afterbody.

The investigation indicated that the transverse-step hull with extended afterbody had about the same minimum drag coefficient, 0.0066, as a conventional hull and an angle-of-attack range for minimum drag of 3° to 5°. The hull with a deep unfaired step had a minimum drag coefficient of 0.0057; which was 14 percent less than the transverse-step hull with extended afterbody; the hulls with step fairing had up to 44 percent less minimum drag coefficient than the transverse-step hull. Longitudinal and lateral instability varied little with step fairing and was about the same as for a conventional hull.

INTRODUCTION

In view of the requirements for increased range and speed in flying-boat designs, an investigation of the aerodynamic characteristics of flying-boat hulls as affected by hull dimensions and hull shape has

¹Supersedes the recently declassified NACA RM L8I27 entitled "Aerodynamic Characteristics of Three Deep-Step Planing-Tail Flying-Boat Hulls" by John M. Riebe and Rodger L. Naeseth, 1948, and NACA RM L6J23a entitled "Aerodynamic Characteristics of Langley Tank Model 203 with Extended Afterbody" by John M. Riebe and Rodger L. Naeseth, 1946.

been conducted at the Langley Aeronautical Laboratory of the National Advisory Committee for Aeronautics. The results of one phase of the investigation, presented in reference 1, have indicated that substantial drag reductions can be obtained for planing-tail flying-boat hulls if proper step fairings are incorporated in the hull. In the present investigation, exploratory tests were made to determine whether further drag reductions might be obtained on this type of hull by deepening the step and thereby reducing the skin area.

Results of tests in the Langley tank no. 2 (reference 2) have indicated that the three deep-step hulls of the present investigation would have satisfactory hydrodynamic characteristics.

Hydrodynamic tests (reference 3) have indicated that an extension of the sternpost of conventional flying-boat hulls to the aft perpendicular generally results in some improvement in landing behavior in rough water. In order to determine the effect of such a change on the aerodynamic characteristics of one of the hulls previously tested (model 203, reference 4) and for the purpose of comparison with the deep-step planing-tail hulls, tests of a transverse-step extended-afterbody hull were also made.

As in the previous aerodynamic investigations of flying-boat hulls (references 1, 4, and 5), all hull aerodynamic characteristics determined include the effect of interference of the support wing.

COEFFICIENTS AND SYMBOLS

The results of the tests are presented as standard NACA coefficients of forces and moments. Rolling-moment, yawing-moment, and pitching-moment-coefficients are given about the locations (wing 30-percent-chord point) shown in figures 1 and 2. Except where noted, the wing area, mean aerodynamic chord, and span used in determining the coefficients and Reynolds numbers are those of the flying boat described in reference 4. The data are referred to the stability axes, which are a system of axes having their origin at the center of moments shown in figures 1 and 2 and in which the Z-axis is in the plane of symmetry and perpendicular to the relative wind, the X-axis is in the plane of symmetry and perpendicular to the Z-axis, and the Y-axis is perpendicular to the plane of symmetry. The positive directions of the stability axes are shown in figure 3.

The coefficients and symbols are defined as follows:

C_L lift coefficient (Lift/qS)
 C_D drag coefficient (Drag/qS)

C_{D_V}	drag coefficient based on volume v of hull $\left(\frac{\text{Drag}}{qv^{2/3}}\right)$
C_{D_A}	drag coefficient based on maximum cross-sectional area A of hull (Drag/qA)
C_{D_W}	drag coefficient based on surface area W of hull (Drag/qW)
C_Y	lateral-force coefficient (Y/qS)
C_l	rolling-moment coefficient (L/qSb)
C_m	pitching-moment coefficient $(M/qS\bar{c})$
C_n	yawing-moment coefficient (N/qSb)

Lift = $-Z$

Drag = $-X$ when $\psi = 0$

X	force along X-axis, pounds
Y	force along Y-axis, pounds
Z	force along Z-axis, pounds
L	rolling moment, foot-pounds
M	pitching moment, foot-pounds
N	yawing moment, foot-pounds
q	free-stream dynamic pressure, pounds per square foot $(\rho V^2/2)$
S	wing area of $\frac{1}{10}$ -scale model of flying boat (18.264 sq ft)
\bar{c}	wing mean aerodynamic chord of $\frac{1}{10}$ -scale model of flying boat (1.377 ft)
b	wing span of $\frac{1}{10}$ -scale model of flying boat (13.971 ft)
V	air velocity, feet per second
ρ	mass density of air, slugs per cubic foot

α	angle of attack of hull base line, degrees
ψ	angle of yaw, degrees
R	Reynolds number, based on wing mean aerodynamic chord of $\frac{1}{10}$ - scale model of flying boat
$\frac{\partial C_m}{\partial \alpha}$	rate of change of pitching-moment coefficient with angle of attack
$\frac{\partial C_n}{\partial \psi}$	rate of change of yawing-moment coefficient with angle of yaw
$\frac{\partial C_Y}{\partial \psi}$	rate of change of lateral-force coefficient with angle of yaw
K_F	fuselage or hull moment factor, equivalent to $\frac{\partial C_m}{\partial \alpha}$, C_m based on hull beam and length and α measured in radians
$\frac{\partial C_{n_F}}{\partial \psi}$	rate of change of fuselage or hull yawing-moment coefficient with angle of yaw, yawing moment based on hull volume and measured about reference axis 0.3 hull length from nose
$\frac{\partial C_n}{\partial \beta}$	rate of change of yawing-moment coefficient with angle of sideslip β , yawing moment based on hull side area and length and measured about reference axis 0.3 hull length from nose and β in radians

Subscript:

min minimum

MODEL AND APPARATUS

The deep-step hull lines of Langley tank models 221E, 221G, and 221F were drawn by the Langley Hydrodynamics Division by increasing the step of hull 221B of reference 1 from a depth which was 23 percent of the hull beam to a depth 92 percent of the hull beam and by maintaining the same height at the sternpost. Dimensions of the hulls are given in figure 1 and tables I to III; drawings of the deep-step fairings are shown in figure 4. The transverse-step hull with extended afterbody (Langley tank model 203 with extended afterbody) was the same as Langley tank model 203 of reference 4 with the exception of sternpost location and afterbody angle of keel (fig. 5). Dimensions of the hull are given in figure 2 and table IV. General proportions for a step fairing for the transverse-step hull with extended afterbody are given in figure 6.

The test model was the same one used in the investigation of reference 1; transformation from one hull to another was facilitated by cutting the underpart of the model and by replacing interchangeable blocks corresponding to each step-fairing condition. The hull and interchangeable blocks were of laminated-mahogany construction and were finished with pigmented varnish.

The volumes, surface areas, maximum cross-sectional areas, and side areas for the hulls are compared in the following table:

Hull	Volume (cu in.)	Surface area (sq in.)	Maximum cross- sectional area (sq in.)	Side area (sq in.)
203 with extended afterbody	13,338	4857	182	1845
221E	10,354	4164	182	1512
221G	10,904	4217	182	1568
221F	11,502	4314	182	1636

The hull was attached to a wing which was mounted horizontally as shown in figure 7. The wing (which was the same as that of references 1, 4, and 5) was set at an angle of incidence of 4° on all models, had a 20-inch chord, and was of NACA 4321 airfoil section.

TESTS

Test Conditions

The tests were made in the Langley 300 MPH 7- by 10-foot tunnel. Test conditions are summarized in the following table:

q (lb/sq ft)	V (mph)	R	M
Tests with extended afterbody ^a			
25	100	1.25×10^6	0.13
170	275	2.95	.35
Tests with all hulls			
25	100	1.30×10^6	0.13
100	201	2.50	.26
170	274	3.10	.35

^aThese tests were made first with just the transverse-step hull with extended afterbody; subsequent tests were made with this hull and the three deep-step hulls.

Corrections

Blocking corrections have been applied to the wing-alone data and to the wing-and-hull data. The hull drag has been corrected for horizontal-buoyancy effects caused by a tunnel static-pressure gradient. Angles of attack have been corrected for structural deflections caused by aerodynamic forces.

Test Procedure

The aerodynamic characteristics of the hulls with interference of the support wing were determined by testing the wing alone and the wing-and-hull combinations under similar conditions. The hull aerodynamic coefficients were thus determined by subtraction of wing-alone coefficients from wing-and-hull coefficients.

Tests were made at several Reynolds numbers. The tests of the extended-afterbody hull with and without step fairing were made before the tests of the three deep-step hulls and were limited in angle-of-attack range because of structural limitations of the support wing. The subsequent tests with all the models were made with a reinforced wing. As a result of the reinforcement, the angle-of-attack range was increased and the angle of attack for minimum drag was reached at a Reynolds number of 2.5×10^6 with all the hulls.

In order to minimize possible errors resulting from transition shift on the wing, the wing transition was fixed at the leading edge by means of roughness strips of carborundum particles of approximately 0.008-inch diameter. The particles were applied for a length of 8 percent airfoil chord measured along the airfoil contour from the leading edge on both upper and lower surfaces.

Hull transition for all tests was fixed by a strip of 0.008-inch-diameter carborundum particles 1/2 inch wide and located at approximately 5 percent of the hull length aft of the bow. All tests were made with the support setup shown in figure 7.

RESULTS AND DISCUSSION

The aerodynamic characteristics of the deep-step planing-tail hulls in pitch are presented in figure 8; aerodynamic characteristics in yaw are given in figure 9. The aerodynamic characteristics of Langley tank model 203 with extended afterbody in pitch are presented in figures 10 and 11, and the aerodynamic characteristics in yaw are presented in figure 12.

Langley tank model 203 with extended afterbody had a minimum drag coefficient of 0.0066, which is about the same as for a conventional hull of the same over-all-length - beam ratio (reference 4); the angle-of-attack range for minimum drag extended from 3° to 5°. Although the angle of attack for minimum drag was not reached, extrapolation of the data of figure 11 indicated that incorporating a step fairing which extended nine times the depth of the step at the keel would result in a reduction of about 11 percent in minimum drag coefficient.

The hull with the unfaired deep step, model 221E, had a minimum drag coefficient of 0.0057 which was 14 percent less than the hull with extended afterbody or a conventional hull. Comparison of the drag results of hull 221E with those of hull 221B of reference 1 indicates that increasing the step from a depth 23 percent of the hull beam to 92 percent of the hull beam resulted in a drag-coefficient reduction of 12 percent. The hull with the fairing which had elements approaching straight lines, model 221F, had a minimum drag coefficient of 0.0037; according to reference 5 a streamlined body having approximately the same length and volume and the same wing interference had about 25 percent less minimum drag. The importance of proper step-fairing design in reducing aerodynamic drag on deep-step planing-tail hulls is shown by the larger value of drag coefficient, 0.0045, for hull 221G with the concave step fairing. The drag coefficient for this hull configuration was about 32 percent less than the hull with extended afterbody; whereas hull 221F with the fuller fairing was about 44 percent less.

Tuft studies of the step part of the planing-tail hulls (fig. 13) indicate that the lower drag for the hulls with step fairing results from the elimination of separation which occurs on the sides of the unfaired deep-step hull.

Minimum drag coefficients based on the volume to the two-thirds power $(C_{Dv})_{min}$, on maximum cross-sectional area $(C_{DA})_{min}$, and on surface area $(C_{DW})_{min}$ are presented in table V along with minimum drag coefficients based on wing area. These data indicate that hull 221F had the least drag for a unit volume and for unit surface areas.

It should be noted when the results of this paper are compared with the results of hulls tested alone that subtraction of wing-alone data from wing-and-hull data, the method used to determine the hull-and-wing interference data in this paper, results in a lower minimum drag coefficient because of negative wing interference drag. This characteristic results because an appreciable part of the support wing was enclosed by the hull and shielded from the air stream. Unless this favorable interference effect is considered when comparisons are made with other hull-drag or fuselage-drag data, the drag coefficients tabulated herein, especially $(C_{DW})_{min}$, may seem abnormally low.

As with the planing-tail hulls of a previous investigation (reference 1), the angle-of-attack range for minimum drag occurred from about 3° to 5° .

Longitudinal and lateral instability, as shown by the parameters $\partial C_m / \partial \alpha$, $\partial C_n / \partial \psi$, and $\partial C_Y / \partial \psi$ (table V), varied little with step fairing and was about the same as for a conventional hull or for a hull with extended afterbody.

In order to compare the results of these tests with results of investigations made of other hulls and fuselages, the parameters K_f , $\partial C_{n_f}' / \partial \psi'$, and $\partial C_n / \partial \beta$, as derived from references 6, 7, and 8, respectively, are also included in table V. The parameter K_f is a fuselage moment factor, in the form of $\partial C_m / \partial \alpha$ based on hull beam and length where α is in radians. The yawing-moment coefficient C_{n_f}' in $\partial C_{n_f}' / \partial \psi'$ is based on volume and is given about a reference axis 0.3 hull length from the nose. The parameter $\partial C_n / \partial \beta$ is based on hull side area and length, where the yawing moment is also given about a reference axis 0.3 hull length from the nose and β is given in radians. Instability as given by the parameters $\partial C_{n_f}' / \partial \psi'$ and $\partial C_n / \partial \beta$ agreed closely with values given in references 7 and 8.

CONCLUSIONS

The results of an investigation to determine the aerodynamic characteristics of three deep-step planing-tail flying-boat hulls which differed only in the amount of step fairing and, for the purpose of comparison, of a transverse-step hull with an extended afterbody indicated the following conclusions:

1. The transverse-step hull with extended afterbody had about the same minimum drag coefficient, 0.0066, as a conventional hull.
2. The planing-tail hull with a deep unfaired step had a minimum drag coefficient of 0.0057, about 14 percent less than the transverse-step hull with extended afterbody; the hulls with step fairing had up to 44 percent less minimum drag coefficient than the transverse-step hull.
3. The angle-of-attack range for minimum drag was generally between 3° and 5° for all planing-tail hulls tested.

4. Longitudinal and lateral instability was the same for all planing-tail hulls and was about the same as for the transverse-step hull with extended afterbody or for a conventional hull.

Langley Aeronautical Laboratory
National Advisory Committee for Aeronautics
Langley Field, Va., October 6, 1947

REFERENCES

1. Yates, Campbell C., and Riebe, John M.: Aerodynamic Characteristics of Three Planing-Tail Flying-Boat Hulls. NACA TN 1306, 1947.
2. Suydam, Henry B.: Hydrodynamic Characteristics of a Low-Drag, Planing-Tail Flying-Boat Hull. NACA TN 2481, 1952. (Supersedes NACA RM L7110.)
3. Kapryan, Walter J., and Clement, Eugene P.: Effect of Increase in Afterbody Length on the Hydrodynamic Qualities of a Flying-Boat Hull of High Length-Beam Ratio. NACA TN 1853, 1949.
4. Yates, Campbell C., and Riebe, John M.: Effect of Length-Beam Ratio on the Aerodynamic Characteristics of Flying-Boat Hulls. NACA TN 1305, 1947.
5. Riebe, John M., and Naeseth, Rodger L.: Aerodynamic Characteristics of a Refined Deep-Step Planing-Tail Flying-Boat Hull with Various Forebody and Afterbody Shapes. NACA TN 2489, 1952. (Supersedes NACA RM L8F01.)
6. Gilruth, R. R., and White, M. D.: Analysis and Prediction of Longitudinal Stability of Airplanes. NACA Rep. 711, 1941.
7. Pass, H. R.: Analysis of Wind-Tunnel Data on Directional Stability and Control. NACA TN 775, 1940.
8. Imlay, Frederick H.: The Estimation of the Rate of Change of Yawing Moment with Sideslip. NACA TN 636, 1938.

TABLE I
OFFSETS FOR LARKLEY TANK MODEL 221E

[All dimensions are in inches]

Station	Distance to F.P.	Keel above base line	Cove above base line	Upper chine above base line	Lower chine above base line	Lower chine half beam	Radius and half maximum beam	Height of hull at center line	Line of centers above base line	Angle of chine flare (deg)	Heights and half-breadths of bottom of hull for buttocks of								
											1/2 in.	1 in.	1 1/2 in.	2 in.	2 1/2 in.	3 in.	3 1/2 in.	4 in.	4 1/2 in.
F.P.	0	10.30			10.30	0	0	11.00	11.00										
1/2	2.13	5.49			8.30	2.30	2.30	14.29	11.98	10	6.48	7.49	8.14	8.32					
1	4.25	3.76			6.71	3.06	3.06	15.72	12.66	10	4.52	5.30	6.09	6.56					
2	6.50	1.83			4.59	3.86	3.86	17.36	13.50	10	2.40	2.96	3.53	4.01	4.38	4.60			
3	12.75	.80			3.24	4.32	4.32	18.41	14.08	10	1.21	1.64	2.06	2.49	2.85	3.10	3.25	3.28	
4	17.00	.27			2.36	4.61	4.61	19.12	14.52	10	.59	.92	1.25	1.58	1.89	2.14	2.33	2.42	2.38
5	21.25	.04			1.81	4.79	4.79	19.60	14.81	10	.29	.55	.80	1.04	1.30	1.52	1.70	1.82	1.85
6	25.50	0			1.51	4.89	4.89	19.88	14.99	5	.19	.40	.59	.78	.98	1.18	1.33	1.46	1.52
7	29.75	0			1.40	4.92	4.92	19.99	15.07	0	.18	.36	.55	.73	.92	1.09	1.23	1.33	1.40
8	34.00	0	10.29	10.29	1.40	4.925	4.925	20.00	15.08	0	.18	.36	.55	.73	.92	1.09	1.23	1.33	1.40
9	38.25	0	10.32	10.47	1.39	4.50	4.925	20.00	15.08			.36				1.09			
10	42.50	0	10.01	10.66	1.12	3.14	4.925	20.00	15.08						1.09				
11	46.75	0	9.33	10.85	.26	.73	4.925	20.00	15.08										
11 1/2 F	47.90	0	9.08	10.87	0	0	4.925	20.00	15.08										
11 1/2 A	47.90	9.08	9.08	10.87			4.925	20.00	15.08										
12	51.00	9.25		11.01			4.925	20.00	15.08										
13	55.25	9.40		11.19			4.91	20.00	15.09										
14	59.50	9.59		11.36			4.86	20.00	15.14										
15	63.75	9.78		11.51			4.75	20.00	15.25										
16	68.00	9.97		11.65			4.61	20.00	15.39										
17	72.25	10.16		11.77			4.43	20.00	15.57										
18	76.50	10.34		11.86			4.17	20.00	15.83										
19	80.75	10.53		11.94			3.87	20.00	16.13										
20	85.00	10.72		11.99			3.50	20.00	16.50										
21	89.25	10.91		12.03			3.08	20.00	16.92										
22	93.50	11.09		12.04			2.61	20.00	17.39										
23	97.75	11.28		12.06			2.15	20.00	17.85										
24	102.00	11.47		12.08			1.69	20.00	18.31										
25	106.25	11.66		12.10			1.22	20.00	18.78										
26	110.50	11.85		12.12			.76	20.00	19.24										
27	114.75	12.02		12.12			.31	20.00	19.69										
A.P.	116.65	12.12		12.12			.10	20.00	19.90										

NACA

TABLE II
OFFICERS OF LAWLEY TANK MODEL 2210

[All dimensions are in inches]

Sta- tion	Distance to F.P.	Keel above base line	Cove above base line	Upper chine above base line	Lower chine above base line	Lower chine half beam	Radius and half max- imum beam	Height of hull at center line	Line of cen- ters above base line	Angle of chine flare (deg)	Heights and half-breadths of bottom of hull														
											Buttocks (in.)				Water line (in.)										
											1	2	3	4	1	2	3	4	5	6	7	8	9	10	11
F.P.	0	10.30			10.30	0	0	11.00	11.00																
1 ₂	2.23	5.49			8.30	2.30	2.30	14.29	11.98	10	7.49	8.32													
1	4.25	3.76			6.71	3.06	3.06	15.72	12.66	10	5.30	6.56	6.72												
2	8.50	1.83			4.59	3.86	3.86	17.36	13.50	10	2.96	4.01	4.60												
3	12.75	.80			3.24	4.32	4.32	18.41	14.08	10	1.64	2.49	3.10	3.28											
4	17.00	.27			2.36	4.61	4.61	19.12	14.52	10	.92	1.58	2.14	2.42											
5	21.25	.04			1.81	4.79	4.79	19.60	14.81	10	.55	1.04	1.52	1.82											
6	25.50	0			1.51	4.89	4.89	19.88	14.99	5	.40	.78	1.18	1.46											
7	29.75	0			1.40	4.92	4.92	19.99	15.07	0	.36	.73	1.09	1.33											
8	34.00	0	1.50		1.40	4.925	4.925	20.00	15.08	0	.36	.73	1.09	1.33											
9	38.25	0	1.49		1.39	4.50	4.925	20.00	15.08	0	.36	.73	1.09	1.33	4.55	4.62	4.70	4.76	4.82	4.89					
10	42.50	0	1.22		1.12	3.14	4.925	20.00	15.08	0	.36	.73	1.09	1.33	3.35	3.60	3.83	4.08	4.31	4.55	4.75	4.88			
11	46.75	0	.36		.86	.73	4.925	20.00	15.08	0	1.07	3.34	5.55	7.80	.95	1.40	1.85	2.30	2.75	3.20	3.65	4.10	4.50	4.82	
11 ₂ F	47.90	0	.10		0	0	4.925	20.00	15.08	0	2.43	4.40	6.35	8.31	.34	.79	1.28	1.79	2.30	2.82	3.33	3.89	4.33	4.73	
11 ₄ A	47.90	0			0	0	4.925	20.00	15.08	0	2.43	4.40	6.35	8.31	.34	.79	1.28	1.79	2.30	2.82	3.33	3.89	4.33	4.73	
12	51.00	3.63					4.925	20.00	15.08	0	5.25	6.55	7.96	9.36											4.75
13	55.25	6.40					4.91	20.00	15.09	0	7.36	8.35	9.31	10.23											4.40
14	59.50	8.07					4.86	20.00	15.14	0	8.79	9.42	10.07	10.74			.84	.91	1.60	2.32	3.05	3.74	4.42	4.75	
15	63.75	9.10					4.75	20.00	15.25	0	9.59	10.10	10.62	11.11						.62	1.65	2.68	3.75	4.42	4.75
16	68.00	9.73					4.61	20.00	15.39	0	10.13	10.55	11.07	11.38											4.40
17	72.25	10.08					4.43	20.00	15.57	0	10.48	10.85	11.24	11.61											4.40
18	76.50	10.34		11.86			4.17	20.00	15.83	0	10.69	11.07	11.45	11.83											4.40
19	80.75	10.53		11.94			3.87	20.00	16.13	0	10.90	11.26	11.63												4.40
20	85.00	10.72		11.99			3.50	20.00	16.50	0	11.08	11.45	11.81												4.40
21	89.25	10.91		12.03			3.08	20.00	16.92	0	11.27	11.65	12.02												4.40
22	93.50	11.09		12.04			2.61	20.00	17.39	0															4.40
23	97.75	11.28		12.06			2.15	20.00	17.85	0															4.40
24	102.00	11.47		12.08			1.69	20.00	18.31	0															4.40
25	106.25	11.66		12.10			1.22	20.00	18.78	0															4.40
26	110.50	11.85		12.12			.76	20.00	19.24	0															4.40
27	114.75	12.02		12.12			.31	20.00	19.69	0															4.40
A.F.	116.65	12.12		12.12			.10	20.00	19.90	0															4.40



TABLE III
 OFFSETS FOR LANGLEY TANK MODEL 221F

[All dimensions are in inches]

Station	Distance to F.P.	Keel above base line	Cove above base line	Upper chine above base line	Lower chine above base line	Lower chine half beam	Radius and half maximum beam	Height of hull at center line	Line of centers above base line	Angle of chine flare (deg)	Heights and half-breadths of bottom of hull																
											Buttocks (in.)				Water line (in.)												
											1	2	3	4	1	2	3	4	5	6	7	8	9	10	11		
F.P.	0	10.30			10.30	0	0	11.00	11.00																		
1	2.13	5.49			8.30	2.30	2.30	14.29	11.98	10	7.49	8.32															
2	4.25	3.76			6.71	3.06	3.06	15.72	12.66	10	5.30	6.26	6.72														
3	8.50	1.53			4.59	3.86	3.86	17.36	13.50	10	2.96	4.01	4.60														
4	12.75	.80			3.24	4.32	4.32	18.41	14.08	10	1.64	2.49	3.10	3.28													
5	17.00	.27			2.36	4.61	4.61	19.12	14.52	10	.92	1.58	2.14	2.42													
6	21.25	.04			1.81	4.79	4.79	19.60	14.81	10	.55	1.04	1.52	1.82													
7	25.50	0			1.51	4.89	4.89	19.88	14.99	5	.40	.78	1.18	1.46													
8	29.75	0	1.50		1.40	4.92	4.92	19.99	15.07	0	.36	.73	1.09	1.33													
9	34.00	0	1.49		1.40	4.92	4.92	20.00	15.08	0	.36	.73	1.09	1.33													
10	38.25	0	1.22		1.39	4.92	4.92	20.00	15.08		.36	.73	1.09	1.33													
11	42.50	0	.36		1.12	3.14	4.92	20.00	15.08		.66	1.80	3.03	4.62	1.32	2.17	2.99	3.64	4.17	4.56	4.85	4.90					
11 ₁ F	47.90	0	.36		0	0	4.92	20.00	15.08		1.16	2.29	3.52	5.10	.86	1.75	2.60	3.33	3.95	4.41	4.72	4.86					
11 ₂ A	47.90	.10					4.92	20.00	15.08		1.16	2.29	3.52	5.10	.86	1.75	2.60	3.33	3.95	4.41	4.72	4.86					
12	51.00	1.42					4.92	20.00	15.08		2.45	3.54	4.73	6.27		.57	1.51	2.40	3.17	3.85	4.35	4.67	4.86				
13	55.25	3.15					4.91	20.00	15.09		4.14	5.20	6.32	7.75						1.82	2.74	3.50	4.13	4.56	4.85	4.90	
14	59.50	4.77					4.86	20.00	15.14		5.67	6.65	7.67	8.95							1.32	2.34	3.27	4.02	4.57	4.85	
15	63.75	6.26					4.75	20.00	15.25		7.07	7.91	8.84	9.93								.87	2.11	3.15	4.05	4.68	
16	68.00	7.58					4.61	20.00	15.39		8.29	9.05	9.84	10.71									.60	2.11	3.18	4.27	
17	72.25	8.71					4.43	20.00	15.57		9.33	9.97	10.62	11.29										.47	2.05	3.17	
18	76.50	9.62		11.86			4.17	20.00	15.83		10.12	10.66	11.17	11.71												2.70	
19	80.75	10.29		11.94			3.87	20.00	16.13		10.70	11.13	11.54													1.74	
20	85.00	10.71		11.99			3.50	20.00	16.50		11.08	11.45	11.81														.76
21	89.25	10.91		12.03			3.08	20.00	16.92																		
22	93.50	11.09		12.04			2.61	20.00	17.39																		
23	97.75	11.26		12.06			2.15	20.00	17.89																		
24	102.00	11.47		12.08			1.69	20.00	18.31																		
25	106.25	11.66		12.10			1.22	20.00	18.78																		
26	110.50	11.84		12.12			.76	20.00	19.24																		
27	114.75	12.02		12.12			.31	20.00	19.69																		
A 2	116.65	12.12		12.12			.16	20.00	19.94																		

NACA

TABLE IV
OFFSETS FOR LANGLEY TANK MODEL 203 WITH EXTENDED AFTERBODY

[All dimensions are in inches]

Station	Distance to F.P.	Keel above base line	Chine above base line	Radius and half beam at chine	Height of hull at center line	Line of centers above base line	Angle of chine flare (deg)	Forebody bottom, heights above base line for buttocks of											
								$\frac{1}{2}$ in.	1 in.	$1\frac{1}{2}$ in.	2 in.	$2\frac{1}{2}$ in.	3 in.	$3\frac{1}{2}$ in.	4 in.	$4\frac{1}{2}$ in.			
F.P.	0	10.30	10.30	0	11.00	11.00													
1	2.13	5.49	8.30	2.30	14.29	11.98	10	6.48	7.49	8.14	8.32								
2	4.25	3.76	6.71	3.06	15.72	12.66	10	4.52	5.30	6.09	6.56	6.77	6.72						
3	8.50	1.83	4.59	3.86	17.36	13.50	10	2.40	2.96	3.53	4.01	4.38	4.60	4.64					
4	12.75	.80	3.24	4.32	18.41	14.09	10	1.21	1.64	2.06	2.49	2.85	3.10	3.28	3.28				
5	17.00	.27	2.36	4.61	19.12	14.52	10	.59	.92	1.25	1.58	1.89	2.14	2.33	2.42	2.42			2.38
6	21.25	.04	1.81	4.79	19.60	14.81	10	.29	.55	.80	1.04	1.30	1.52	1.70	1.82	1.82			1.85
7	25.50	0	1.51	4.89	19.88	14.99	5	.19	.40	.59	.78	.98	1.18	1.33	1.46	1.46			1.52
8	29.75	0	1.40	4.92	19.99	15.07	0	.18	.36	.55	.73	.92	1.09	1.23	1.33	1.33			1.40
9	34.00	0	1.40	4.925	20.00	15.08	0	.18	.36	.55	.73	.92	1.09	1.23	1.33	1.33			1.40
10	38.25	0	1.40	4.925	20.00	15.08	0	.18	.36	.55	.73	.92	1.09	1.23	1.33	1.33			1.40
11	42.50	0	1.40	4.925	20.00	15.08	0	.18	.36	.55	.73	.92	1.09	1.23	1.33	1.33			1.40
12 F	46.75	0	1.40	4.925	20.00	15.08	0	.18	.36	.55	.73	.92	1.09	1.23	1.33	1.33			1.40
12 A	51.04	0	1.40	4.925	20.00	15.08	0	.18	.36	.55	.73	.92	1.09	1.23	1.33	1.33			1.40
13	51.04	1.16	2.95	4.925	20.00	15.08													
14	55.25	1.78	3.57	4.91	20.00	15.09													
15	59.50	2.41	4.18	4.86	20.00	15.14													
16	63.75	3.04	4.77	4.75	20.00	15.25													
17	68.00	3.66	5.34	4.61	20.00	15.39													
18	72.25	4.29	5.90	4.43	20.00	15.57													
19	76.50	4.92	6.44	4.17	20.00	15.83													
20	80.75	5.55	6.96	3.97	20.00	16.13													
21	85.00	6.17	7.44	3.50	20.00	16.50													
22	89.25	6.80	7.92	3.08	20.00	16.92													
23	93.50	7.43	8.38	2.61	20.00	17.39													
24	97.75	8.06	8.84	2.15	20.00	17.85													
25	102.00	8.69	9.31	1.69	20.00	18.31													
26	106.25	9.31	9.75	1.22	20.00	18.78													
27	110.50	9.94	10.22	.76	20.00	19.24													
A.P.	114.75	10.57	10.68	.31	20.00	19.69													
A.P.	116.65	10.85	10.89	.10	20.00	19.90													



TABLE V

DRAG COEFFICIENTS AND STABILITY PARAMETERS FOR LANGLEY TANK

MODELS 221E, 221G, 221F, AND 203 WITH EXTENDED AFTERBODY

[The drag coefficients are given for a Reynolds number
of about 2.50×10^6]

Model	$C_{D_{min}}$	$(C_{D_V})_{min}$	$(C_{D_A})_{min}$	$(C_{D_W})_{min}$	$\frac{\partial C_m}{\partial \alpha}$	K_f	$\left(\frac{\partial C_n}{\partial \psi}\right)_{\alpha=2^\circ}$	$\left(\frac{\partial C_{n_f'}}{\partial \psi'}\right)_{\alpha=2^\circ}$	$\left(\frac{\partial C_n}{\partial \beta}\right)_{\alpha=2^\circ}$	$\left(\frac{\partial C_Y}{\partial \psi}\right)_{\alpha=2^\circ}$
203 with extended afterbody	0.0066	0.031	0.095	0.0036	0.0050	1.10	0.0011	0.027	-0.098	0.0050
221E	.0057	.032	.082	.0036	.0050	1.10	.0010	.029	-.098	.0048
221G	.0045	.024	.065	.0028	.0050	1.10	.0010	.026	-.090	.0050
221F	.0037	.019	.053	.0023	.0050	1.10	.0010	.026	-.090	.0050



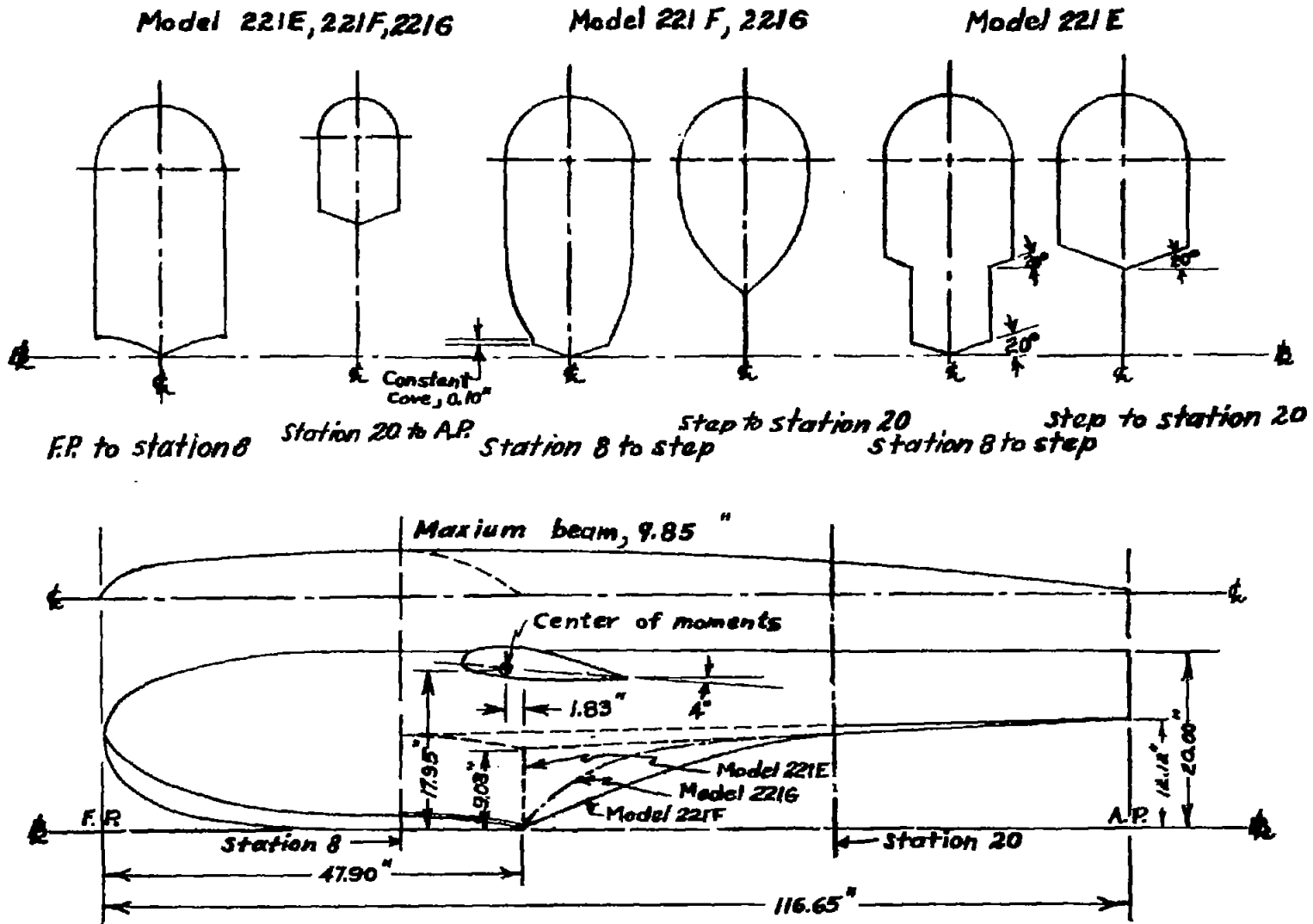

Figure 1.- Lines of Langley tank models 221E, 221G, and 221F.



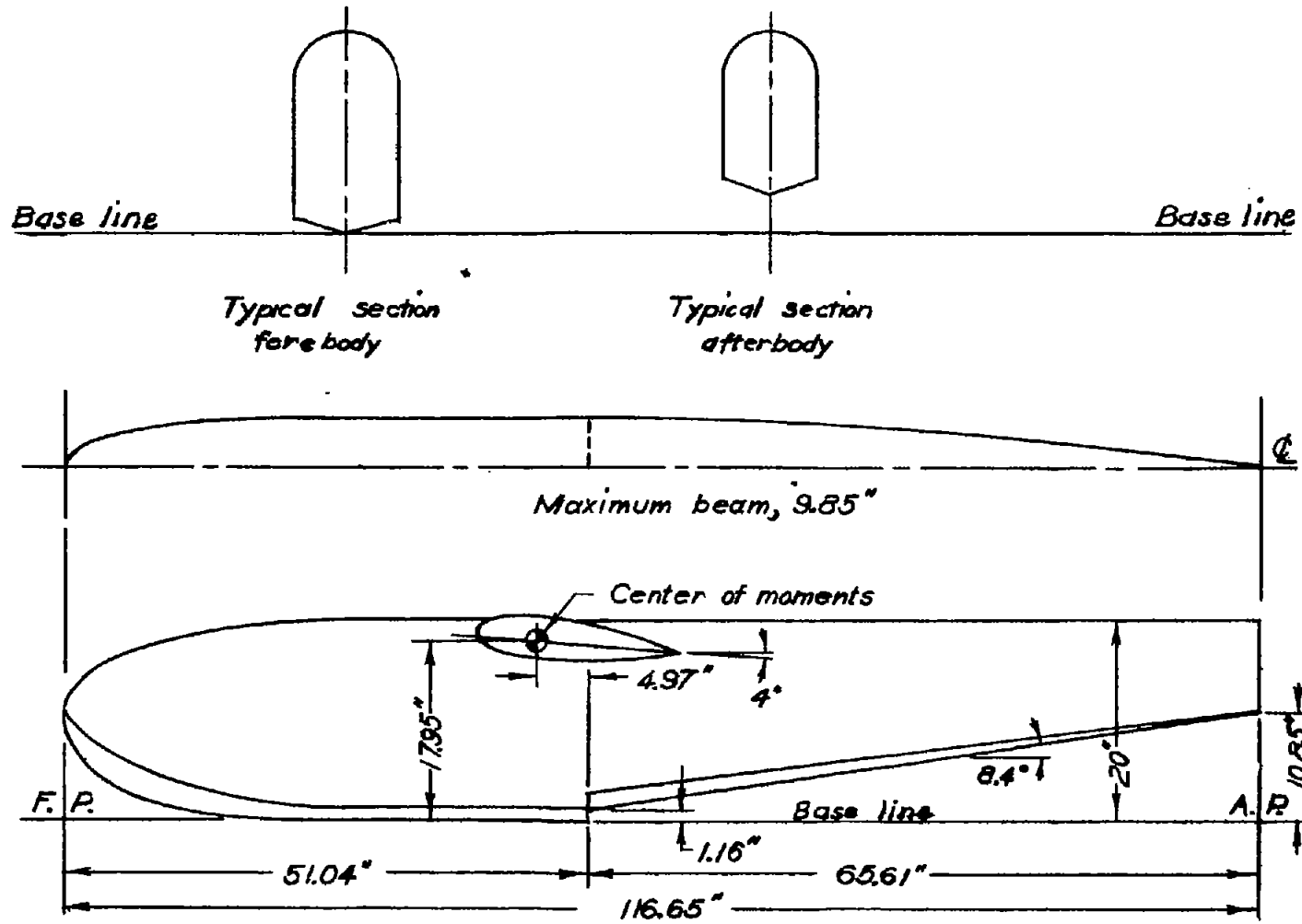

Figure 2.- Lines of Langley tank model 203 with extended afterbody.

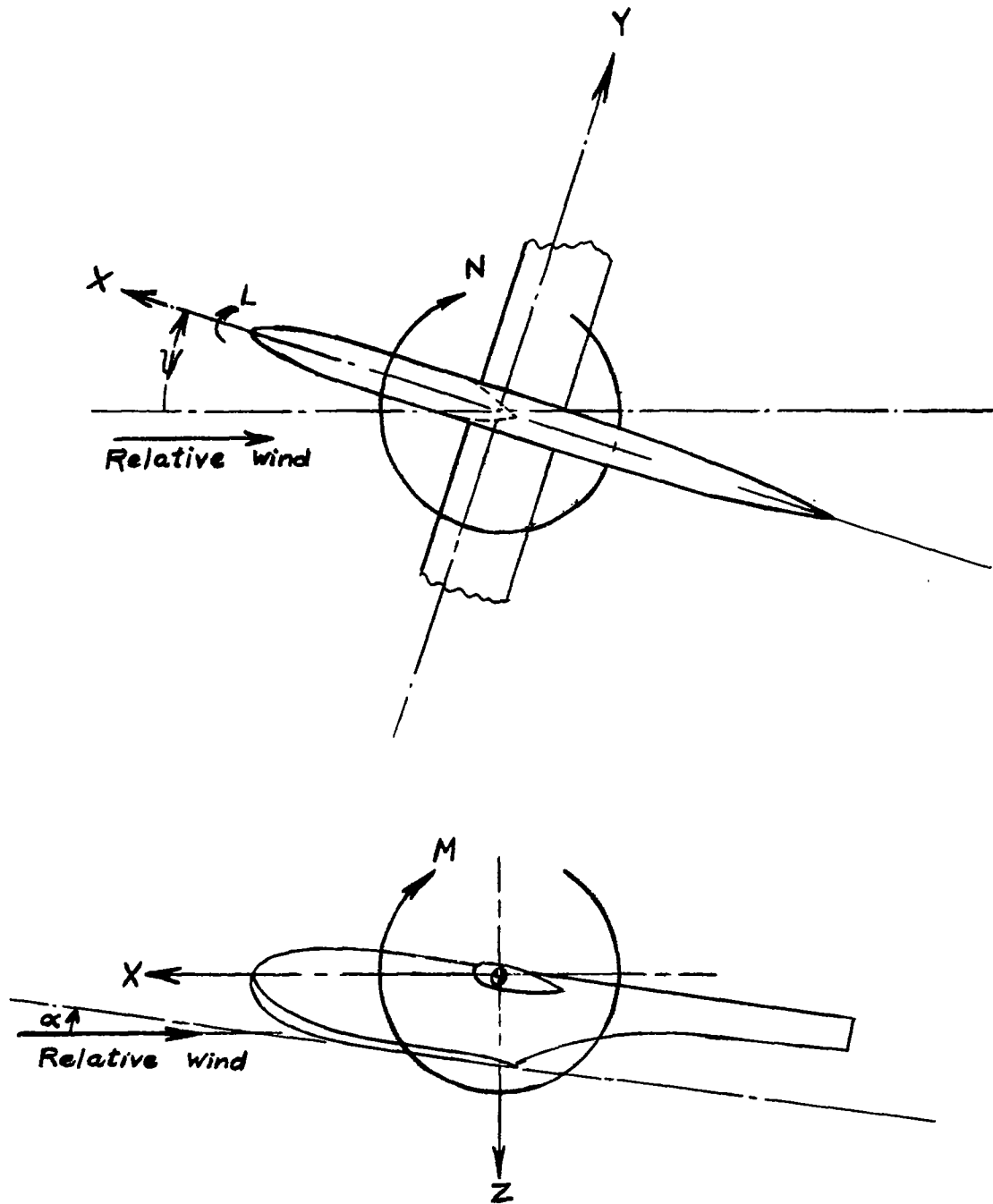

Figure 3.- System of stability axes. Positive values of forces, moments, and angles are indicated by arrows.

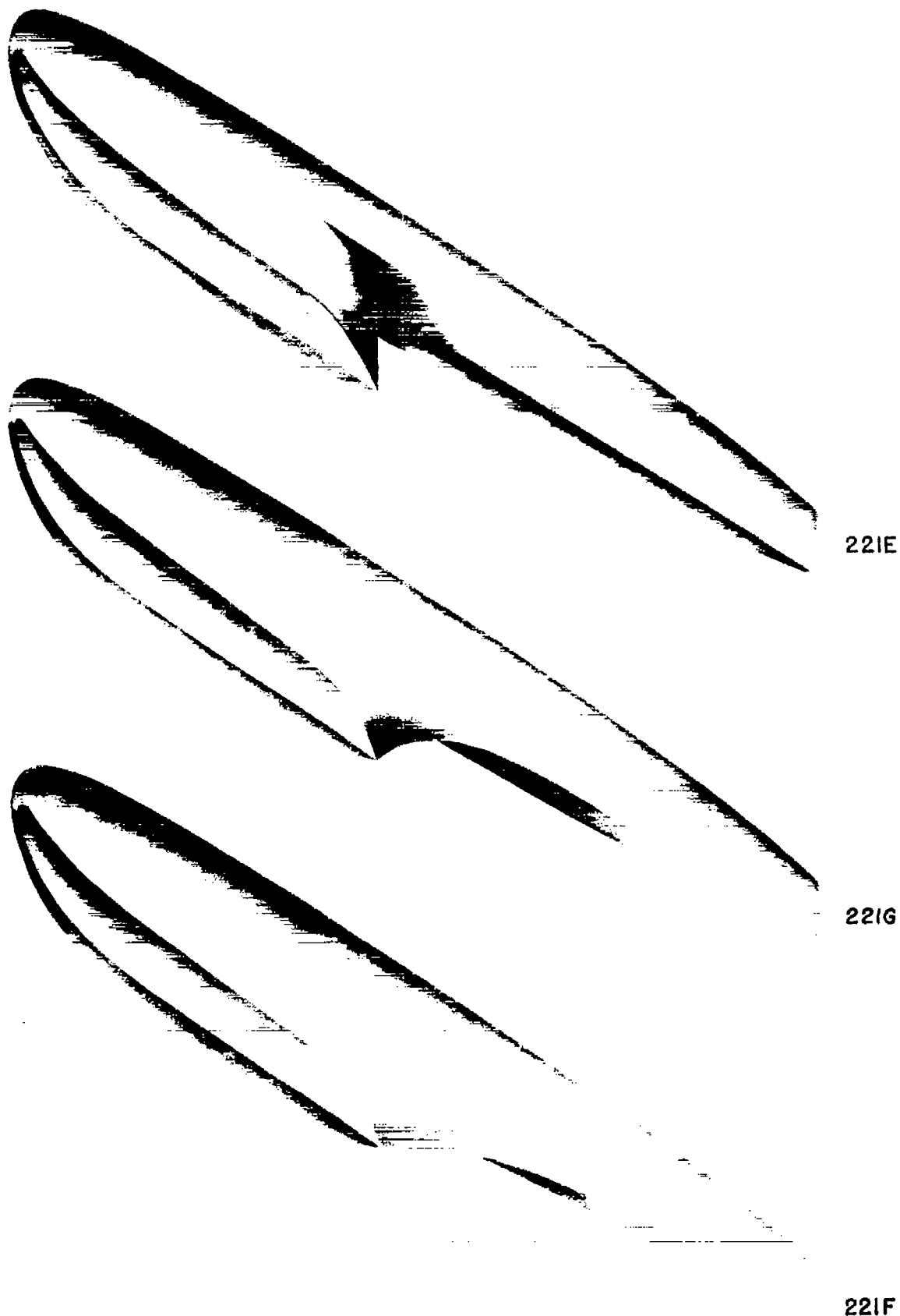

Figure 4.- Langley tank models 221E, 221G, and 221F tested in Langley 300 MPH 7- by 10-foot tunnel.



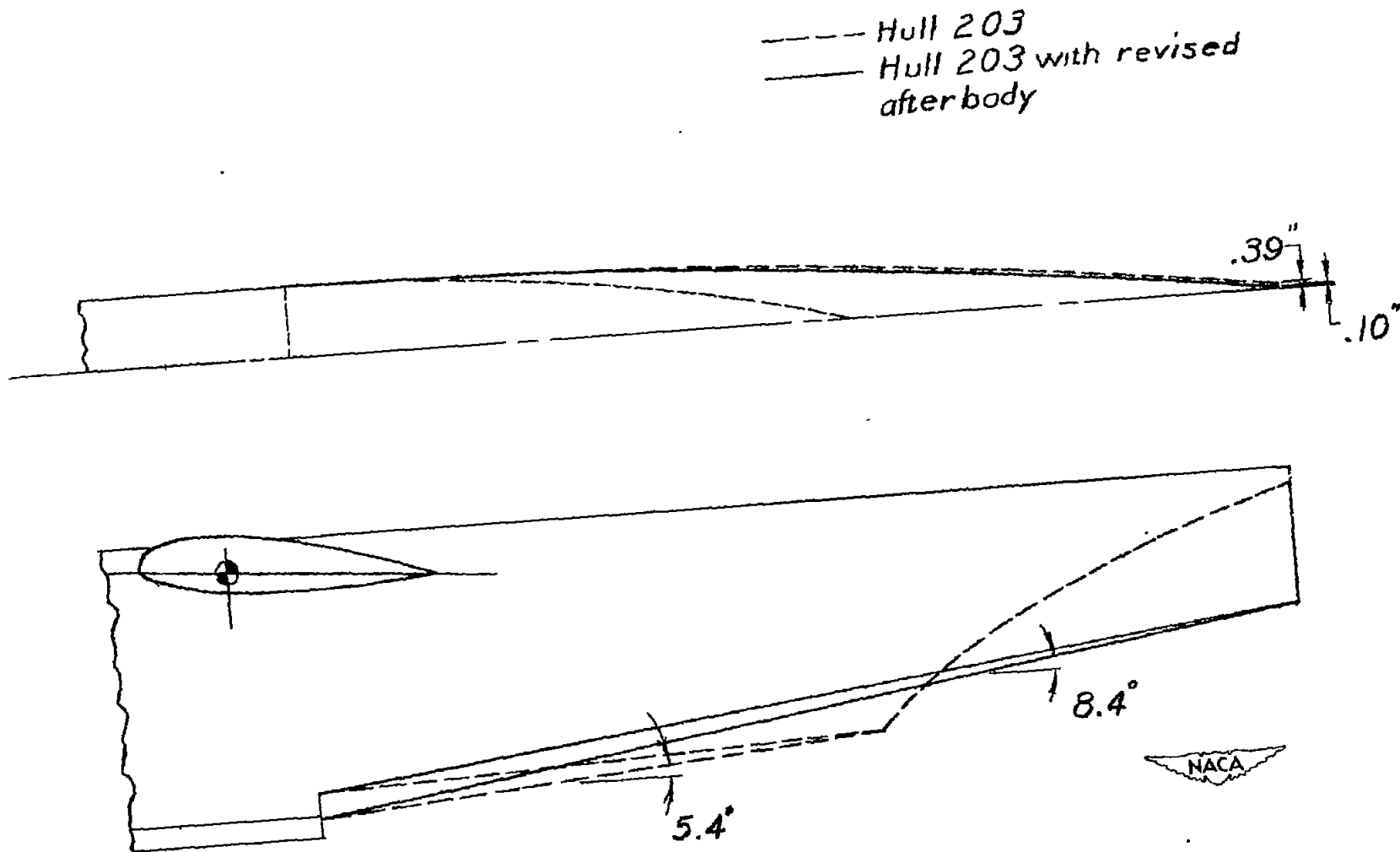

Figure 5.- Revisions to Langley tank model 203 afterbody.

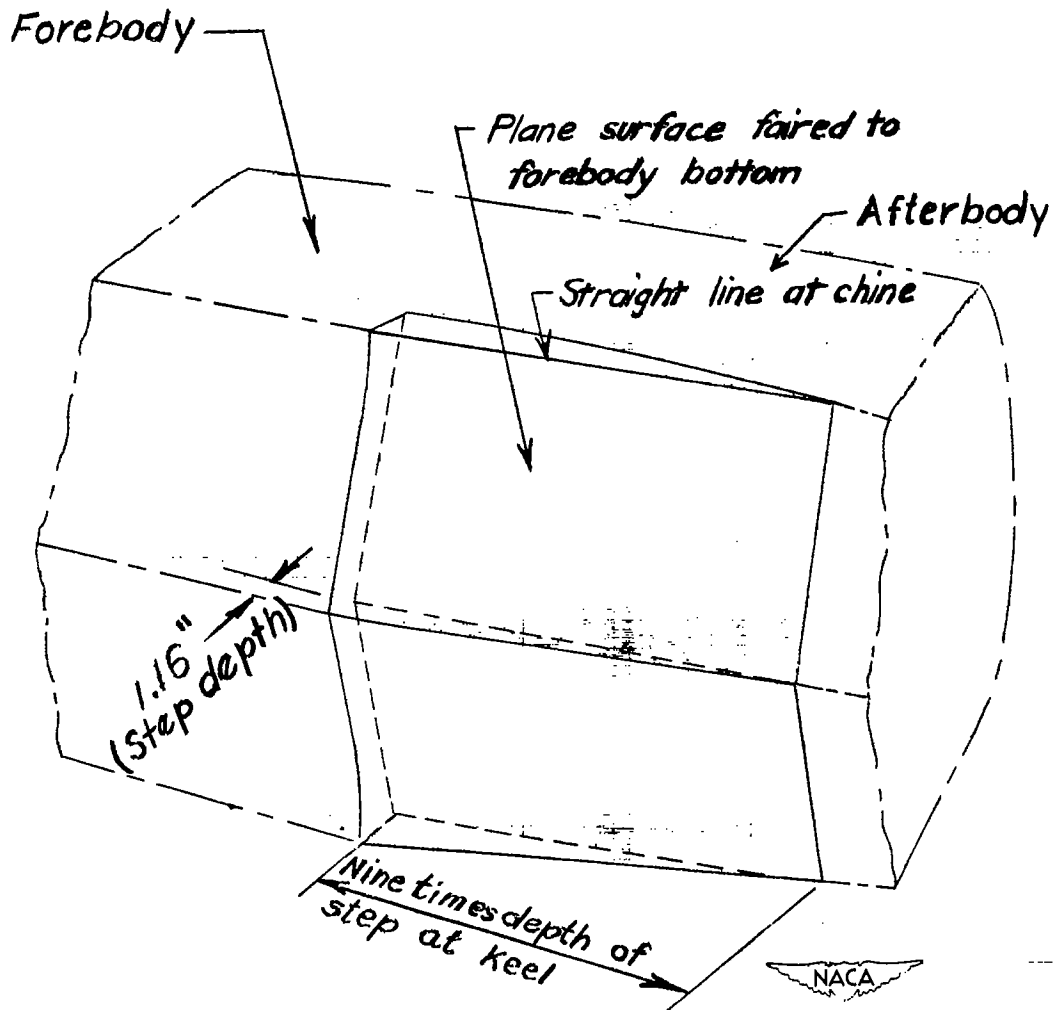

Figure 6.- General details of step fairing for transverse-step hull with extended afterbody. Bottom view of hull.

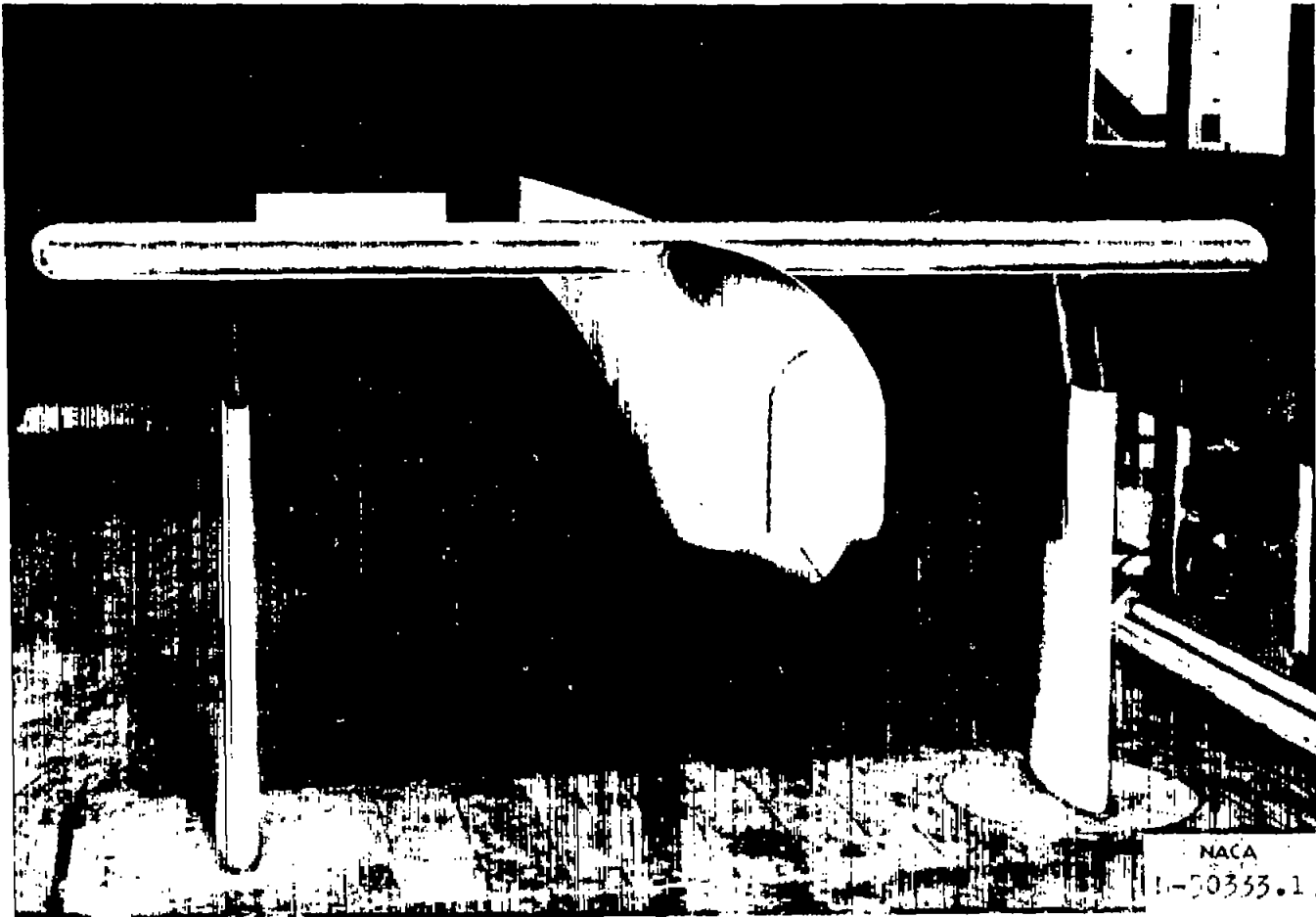
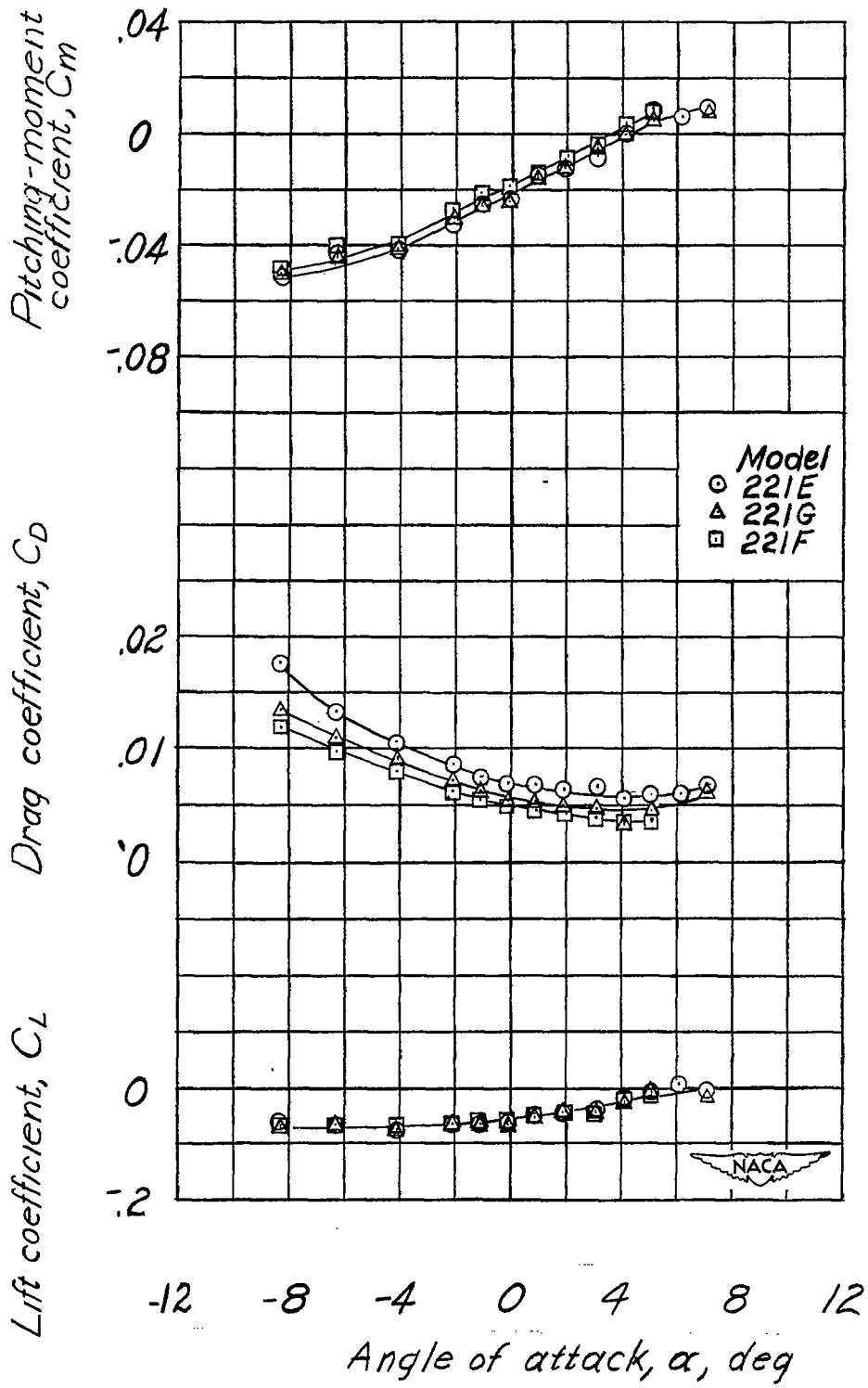
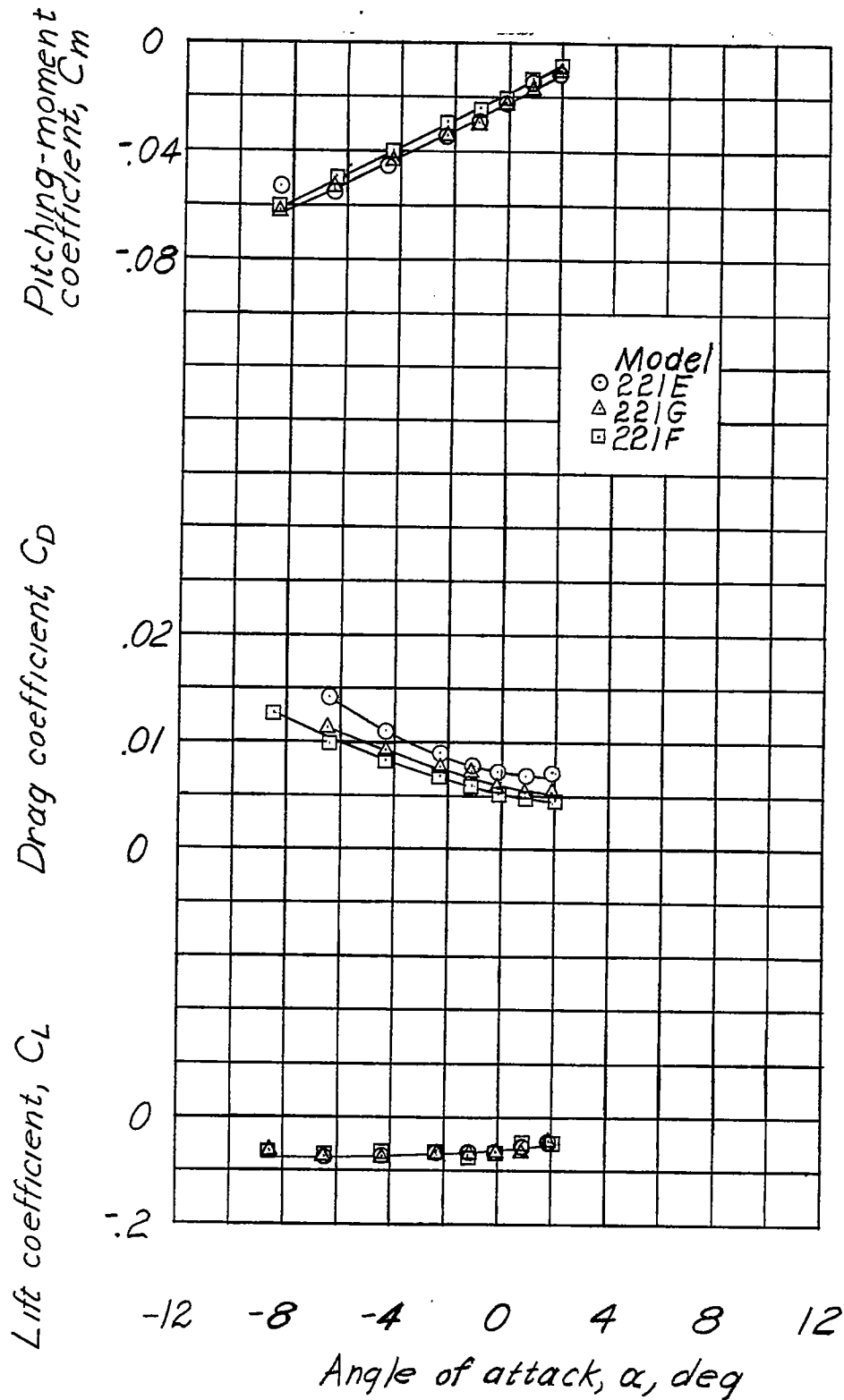

Figure 7.- Langley tank model 221F mounted in Langley 300 MPH
7- by 10-foot tunnel.



(a) $R \approx 2.5 \times 10^6$.

Figure 8.- Aerodynamic characteristics in pitch of Langley tank models 221E, 221G, and 221F.



(b) $R \approx 3.1 \times 10^6$.



Figure 8.- Concluded.

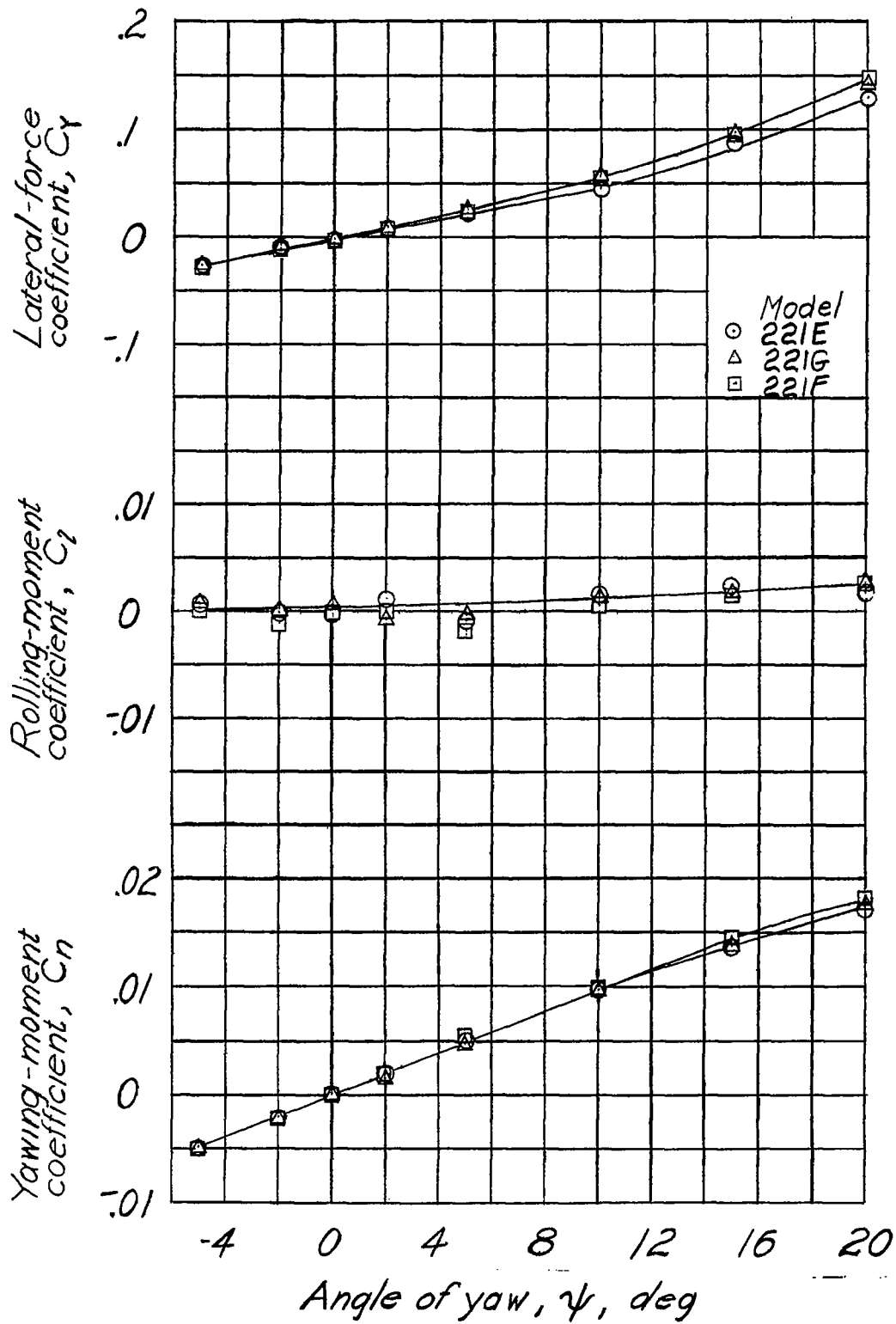

Figure 9.- Aerodynamic characteristics in yaw of Langley tank models 221E, 221G, and 221F. $\alpha = 2^\circ$; $R \approx 1.3 \times 10^6$.

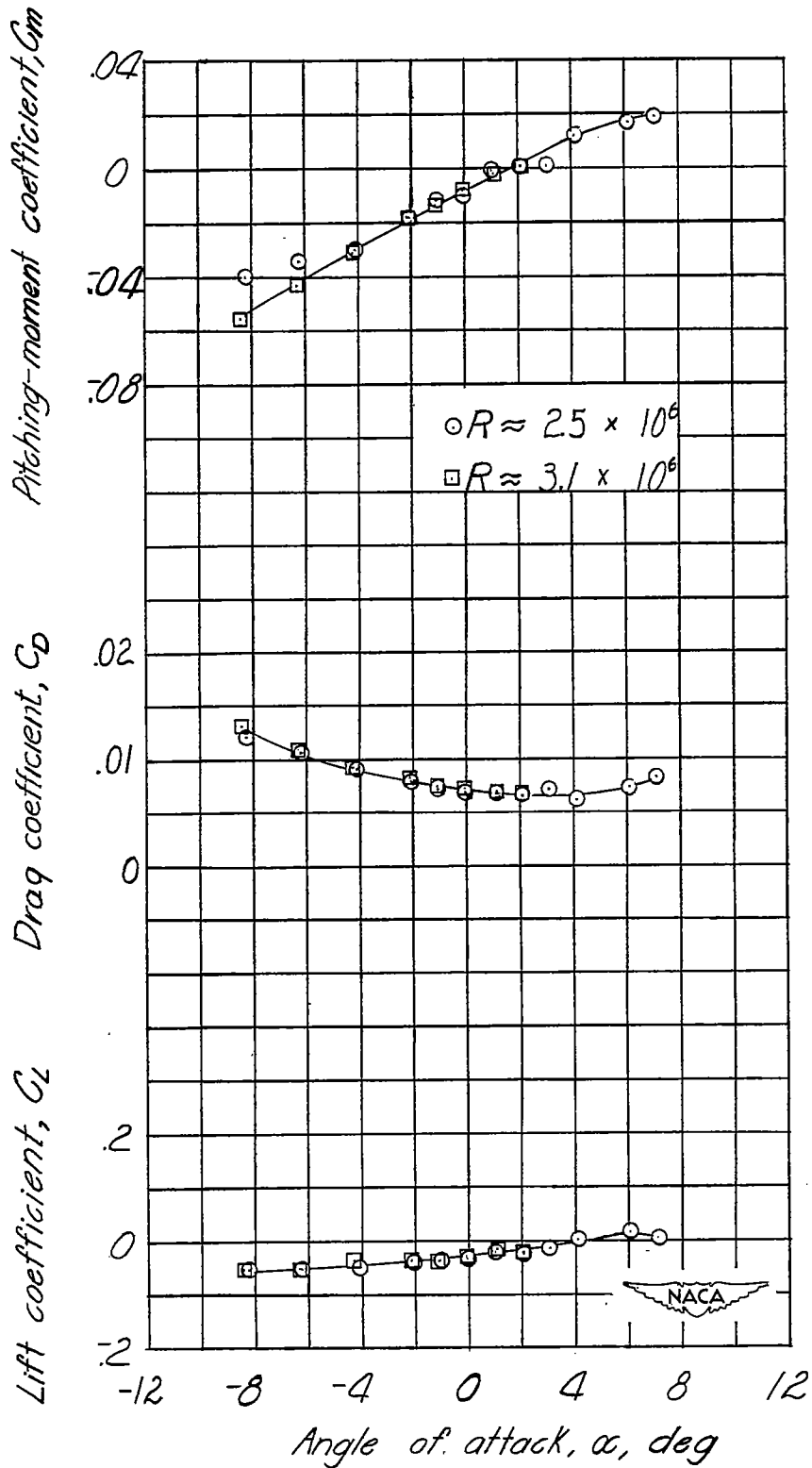

Figure 10.- Aerodynamic characteristics in pitch of Langley tank model 203 with extended afterbody without step fairing.

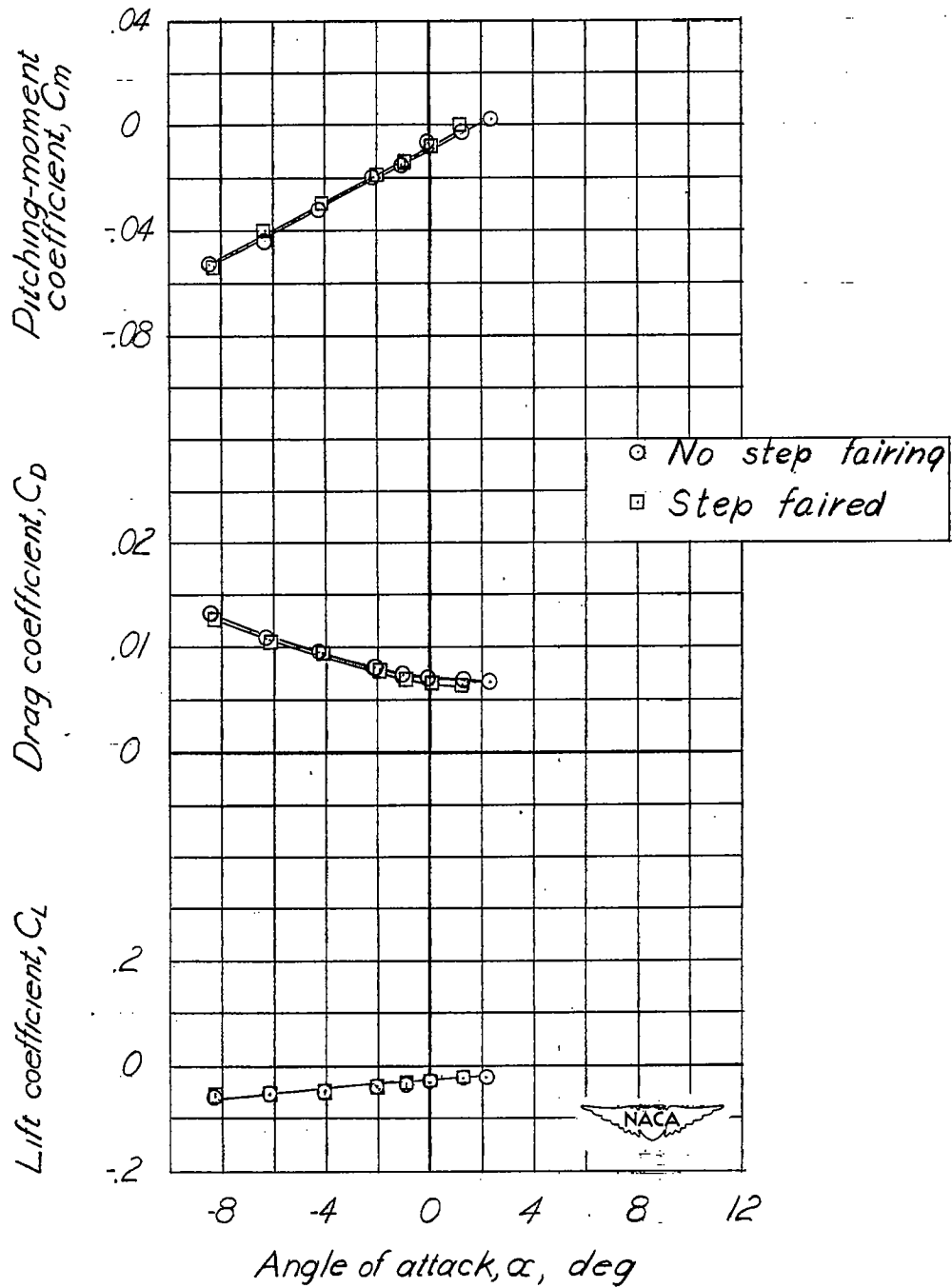

Figure 11.- Aerodynamic characteristics in pitch of Langley tank model 203 with extended afterbody with and without step fairing. $R \approx 2.95 \times 10^6$.

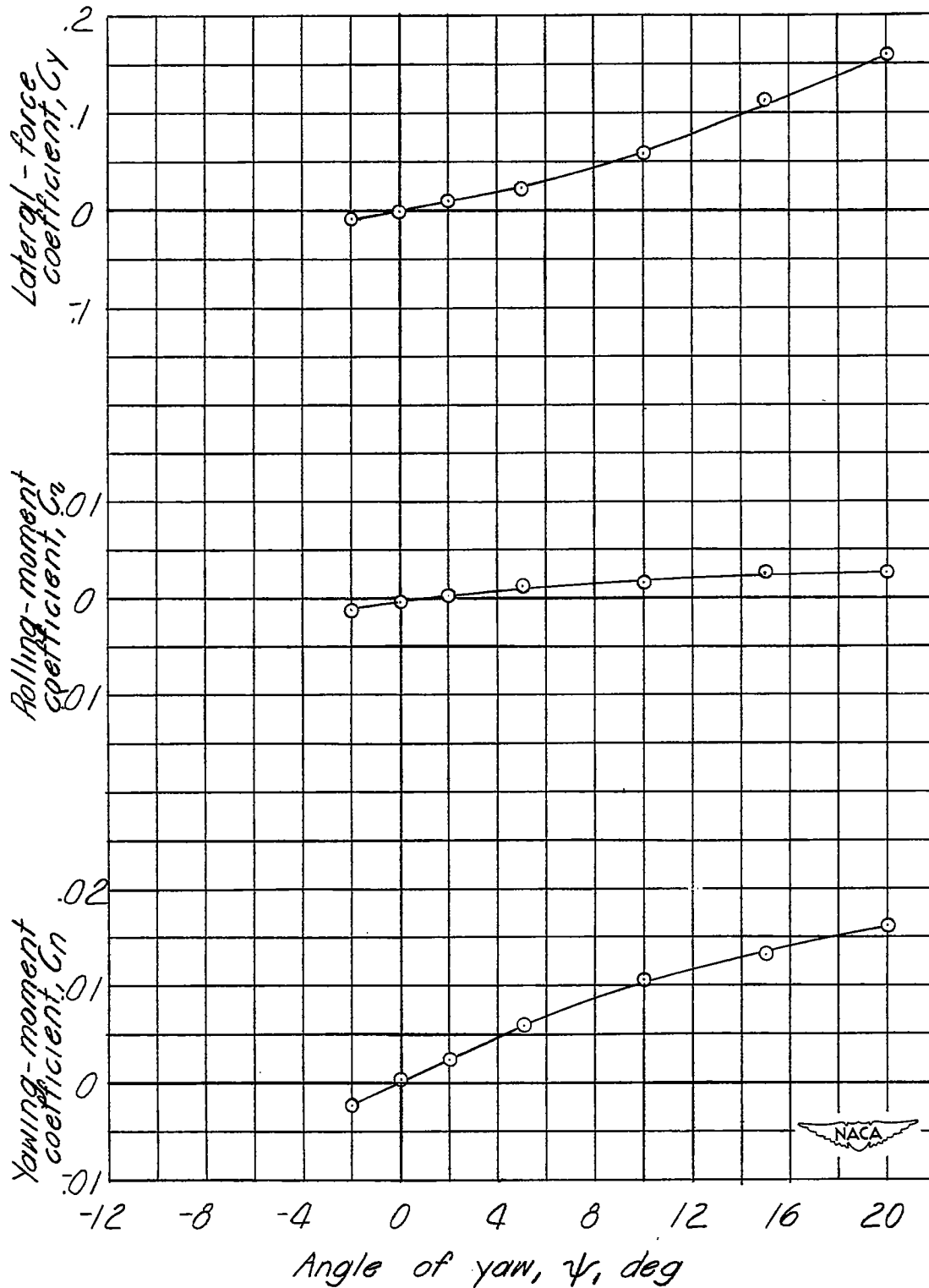
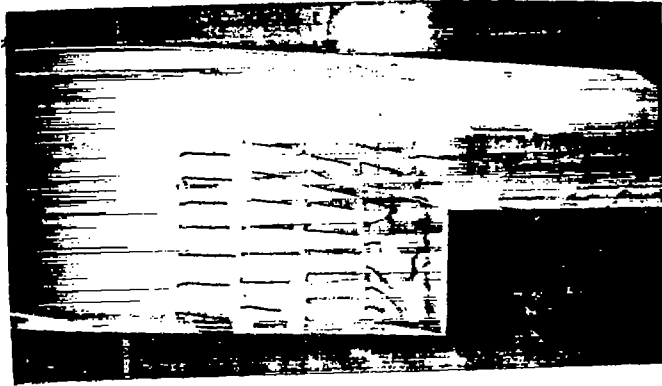
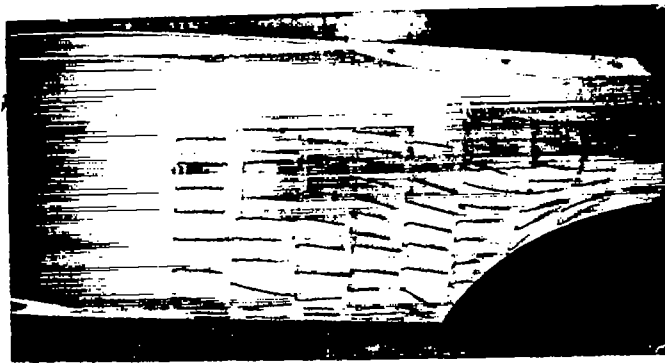

Figure 12.- Aerodynamic characteristics in yaw of Langley tank model 203 with extended afterbody without step fairing. $\alpha = 2^\circ$; $R \approx 1.3 \times 10^6$.



(a) Langley tank model 221E. $\alpha = 2^\circ$.



(b) Langley tank model 221G. $\alpha = 2^\circ$.

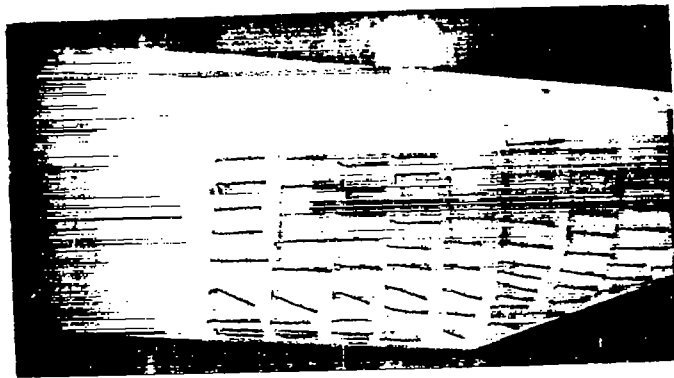

(c) Langley tank model 221F. $\alpha = 4^\circ$.

Figure 13. Tuft studies of Langley tank models 221E, 221G, and 221F.
Tests were made with models mounted on single strut support.

NACA