

NACA RM L52E13

7336



NACA

RESEARCH MEMORANDUM

EFFECT OF FUSELAGE INTERFERENCE ON THE DAMPING IN ROLL OF
DELTA WINGS OF ASPECT RATIO 4 IN THE MACH NUMBER
RANGE BETWEEN 0.6 AND 1.6 AS DETERMINED
WITH ROCKET-PROPELLED VEHICLES

By William M. Bland, Jr.

Langley Aeronautical Laboratory
Langley Field, Va.

319.94/13

CLASSIFIED DOCUMENT



NATIONAL ADVISORY COMMITTEE
FOR AERONAUTICS

WASHINGTON

July 15, 1952

*Receipt signature
required*

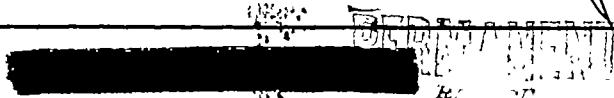



1A

NACA RM L52E13

~~CONFIDENTIAL~~

NATIONAL ADVISORY COMMITTEE FOR AERONAUTICS

RESEARCH MEMORANDUM

EFFECT OF FUSELAGE INTERFERENCE ON THE DAMPING IN ROLL OF

DELTA WINGS OF ASPECT RATIO 4 IN THE MACH NUMBER

RANGE BETWEEN 0.6 AND 1.6 AS DETERMINED

WITH ROCKET-PROPELLED VEHICLES

By William M. Bland, Jr.

SUMMARY

An experimental investigation employing rocket-propelled vehicles in free flight has been made to determine the effect of the fuselage-diameter - wing-span ratio on the damping-in-roll characteristics of delta wings of aspect ratio 4 with 4-percent-thick symmetrical double-wedge airfoil sections in the Mach number range between 0.6 and 1.6. Results of this investigation show that the damping-in-roll derivative was decreased when the fuselage-diameter - wing-span ratio was increased from 0 to 0.4 and then to 0.6. Furthermore, it was shown that the changes noted in the experimental damping-in-roll derivative when the fuselage-diameter - wing-span ratio was changed agreed with the changes predicted by theory for wings with subsonic, sonic, and supersonic leading edges.

INTRODUCTION

Most of the theory describing the damping-in-roll characteristics of various wing plan forms in the Mach number region above 1.0 has been derived for wings without fuselages. Inasmuch as most airplane and missile configurations consist of a wing in combination with a fuselage, a method of determining the fuselage effect and applying it to the wing-alone results is essential. Theoretical results showing the variation of damping in roll with fuselage diameter for various wings, including delta wings, are presented for wings with subsonic leading edges in reference 1 and for wings with supersonic leading edges in reference 2. In order to investigate this problem further, the Langley Pilotless Aircraft Research Division has conducted an investigation to determine the effect of fuselage-diameter - wing-span ratio on the damping-in-roll

~~CONFIDENTIAL~~~~CONFIDENTIAL~~

characteristics of delta wings of aspect ratio 4 with 4-percent-thick symmetrical double-wedge airfoil sections parallel with the free-stream direction. In this investigation, tests were conducted in the high-subsonic, transonic, and supersonic speed ranges with a testing technique (ref. 3) which utilized rocket-propelled vehicles in free flight. During this investigation, experimental data were obtained in the Mach number range between 0.6 and 1.6 and in the Reynolds number range between 0.9×10^6 and 5.2×10^6 (based on the wing-center-line chord). All flight tests were conducted at the Langley Pilotless Aircraft Research Station at Wallops Island, Va.

SYMBOLS

C_{l_p}	damping-in-roll derivative, $\frac{\partial C_l}{\partial \left(\frac{pb}{2V}\right)}$
C_l	rolling-moment coefficient, $\frac{L}{qSb}$
$\frac{pb}{2V}$	wing-tip helix angle, radians
L	rolling moment, ft-lb
q	dynamic pressure, lb/sq ft
S	total included wing area, obtained by extending leading and trailing edges of each semispan wing to the center line, sq ft
b	wing span, ft
A	aspect ratio, b^2/S
d	maximum fuselage diameter, ft
d/b	fuselage-diameter - wing-span ratio
p	rolling velocity, radians/sec
V	flight-path velocity, ft/sec
M	Mach number

$$\frac{C_{l_p}}{(C_{l_p})_w}$$
 ratio of the damping-in-roll derivative of a configuration to the damping-in-roll derivative of a configuration with same wing and $\frac{d}{b} = 0$

$$\beta = \sqrt{M^2 - 1}$$

CONFIGURATIONS TESTED

The configurations tested during this investigation had geometrically similar planar delta wings of aspect ratio 4, leading-edge sweep-back angles of 45° , and 4-percent-thick symmetrical double-wedge airfoil sections parallel to the free-stream direction. Configuration 1 did not have a fuselage ($\frac{d}{b} = 0$) and configurations 2 and 3 had pointed cylindrical fuselages ($\frac{d}{b} = 0.4$ and 0.6 , respectively) as shown in the photographs presented in figure 1. In figure 2 are presented the more important geometric details of the configurations tested. The wings were carefully ground and polished after being machined from steel plate and the fuselages were fabricated from an aluminum alloy.

TEST PROCEDURE

Each configuration tested during this investigation was attached to the sting-like forward section of a test vehicle (fig. 3). This forward section contained a torsion balance to measure the rolling moment generated by the test configuration as it was forced to roll by the test vehicle which had twisted stabilizing fins. During flight, time histories of the rolling moment, rolling velocity, and flight-path velocity were obtained by telemetry, radio, and radar and were used in conjunction with radiosonde measurements of atmospheric conditions encountered to permit evaluation of the damping-in-roll derivative as a function of Mach number. A description of this testing procedure may be found in reference 3.

ACCURACY

The maximum possible systematic errors, due to limitations of the measuring and recording systems, in the values of C_{l_p} presented for

configuration 1, which was tested earlier than configurations 2 and 3, are estimated to be within the following limits:

M	Error in C_{l_p}
0.8	± 0.041
1.2	± 0.017
1.6	± 0.010

However, in reference 3 the results obtained for nearly identical configurations show better agreement than the estimated maximum possible errors indicate. The measuring system employed during the tests of configurations 2 and 3 was improved; accordingly, the maximum possible systematic errors in the values of C_{l_p} presented for these configurations are estimated to be within the following limits:

M	Error in C_{l_p}
0.8	± 0.011
1.2	± 0.010
1.4	± 0.008

The maximum possible error in Mach number is estimated to be ± 0.01 .

RESULTS AND DISCUSSION

Experimental results showing the effect of the fuselage-diameter - wing-span ratio on the variation of the damping-in-roll derivative with Mach number for configurations with delta wings of aspect ratio 4 are presented in figure 4. All the configurations, which had wings with 4-percent-thick symmetrical double-wedge airfoil sections parallel with the free-stream direction, are geometrically similar, differing only in the fuselage-diameter - wing-span ratio. In figure 4, the data obtained for these configurations show that the damping in roll was decreased in the subsonic and supersonic regions when d/b was increased from 0 to 0.4. Also, it is shown that a much greater decrease in damping in roll

was obtained throughout the Mach number range investigated when d/b was increased to 0.6.

Also shown in figure 4 are C_{L_p} values that have been calculated by applying the $C_{L_p}/(C_{L_p})_w$ ratios presented in reference 1 ($\frac{\beta A}{4} \rightarrow 0$) and in reference 2 ($\frac{\beta A}{4} \geq 1$) to the experimental results obtained for the wing alone ($\frac{d}{b} = 0$). The experimental results obtained for configuration 2 ($\frac{d}{b} = 0.4$) and configuration 3 ($\frac{d}{b} = 0.6$) show good agreement with the calculated values. The value $\frac{\beta A}{4} \rightarrow 0$ refers to some velocity at which the wing leading edges are highly sweptback relative to the Mach cone, taken to be $M = 1.05$ in this paper. It is interesting to note the good agreement between the experimental results and the values predicted by the linearized theory at this transonic Mach number. The value $\frac{\beta A}{4} = 1$ refers to the velocity at which the wing leading edges become sonic, $M = 1.414$ for all the wings included in this investigation. When the Mach cone is swept back more than the wing leading edges, $\beta A/4$ becomes greater than 1. A value of $\frac{\beta A}{4} = 1.1$, equivalent to $M = 1.485$, which is near the maximum Mach number for which data were obtained for configurations 2 and 3, was used as the condition for comparing the damping-in-roll values obtained for wings with supersonic leading edges.

Curves, predicted by theory, showing the manner in which the ratio of the damping in roll of a delta-wing and fuselage combination ($\frac{d}{b} > 0$) to the damping in roll of a delta wing alone ($\frac{d}{b} = 0$) varies with fuselage-diameter - wing-span ratio for $\frac{\beta A}{4} \rightarrow 0$, $\frac{\beta A}{4} = 1$, and $\frac{\beta A}{4} = 1.1$ are presented in figure 5 with values determined from the experimental results presented in figure 4. When compared with theory, the experimental values show good agreement, with the agreement best for $\frac{d}{b} = 0.4$.

Also included in figure 5 are some experimental values of $C_{L_p}/(C_{L_p})_w$ obtained for a configuration with $\frac{d}{b} \approx 0.2$ (ref. 3). This configuration differed from configurations 1, 2, and 3 in d/b ratio, in fuselage

profile, and in having a constant-thickness hexagonal airfoil section that was 3.4 percent thick at the root and increased to 7 percent thick at the outboard end of the flat section. Even though the values of C_{l_p} obtained for the configuration with $\frac{d}{b} \approx 0.2$ were divided by values of $(C_{l_p})_w$ obtained for a wing that had a different airfoil section (configuration 1), the ratio $C_{l_p}/(C_{l_p})_w$ agrees very well with theory under the conditions of $\frac{\beta A}{4} = 1$ and $\frac{\beta A}{4} = 1.1$ and indicates, like theory, an increase in damping in roll under the condition of $\frac{\beta A}{4} \rightarrow 0$. This same tendency for C_{l_p} to increase at very low supersonic Mach numbers was indicated by the data in reference 4 when the fuselage-diameter - wing-span ratio was increased from 0 to 0.191 for configurations with straight and with 45° sweptback wings with NACA 65A009 airfoil sections.

CONCLUSIONS

The results of an investigation, made with a technique utilizing rocket-propelled vehicles, to determine the effect of fuselage-diameter - wing-span ratio on the damping-in-roll characteristics of delta wings of aspect ratio 4 in the Mach number range between 0.6 and 1.6 indicate the following conclusions:

1. The damping in roll was decreased in the subsonic and supersonic regions when the fuselage-diameter - wing-span ratio was changed from 0 to 0.4 and decreased much more throughout the Mach number range investigated when the ratio was increased to 0.6.
2. Experimental results showed essentially the same change in damping in roll with changes in fuselage-diameter - wing-span ratio as predicted by theory for the condition where the wing leading edges are highly swept back relative to the Mach cone, the condition where the wing leading edges are sonic, and the condition where the wing leading edges are slightly supersonic.

Langley Aeronautical Laboratory
National Advisory Committee for Aeronautics
Langley Field, Va.

REFERENCES

1. Lomax, Harvard, and Heaslet, Max. A.: Damping-in-Roll Calculations for Slender Swept-Back Wings and Slender Wing-Body Combinations. NACA TN 1950, 1949.
2. Tucker, Warren A., and Piland, Robert O.: Estimation of the Damping in Roll of Supersonic-Leading-Edge Wing-Body Combinations. NACA TN 2151, 1950.
3. Bland, William M., Jr., and Sandahl, Carl A.: A Technique Utilizing Rocket-Propelled Test Vehicles for the Measurement of the Damping in Roll of Sting-Mounted Models and Some Initial Results for Delta and Unswept Tapered Wings. NACA RM L50D24, 1950.
4. Bland, William M., Jr., and Dietz, Albert E.: Some Effects of Fuselage Interference, Wing Interference, and Sweepback on the Damping in Roll of Untapered Wings as Determined by Techniques Employing Rocket-Propelled Vehicles. NACA RM L51D25, 1951.

~~CONFIDENTIAL~~



(a) Configuration 1.

Figure 1.- Photographs of configurations tested.

~~CONFIDENTIAL~~

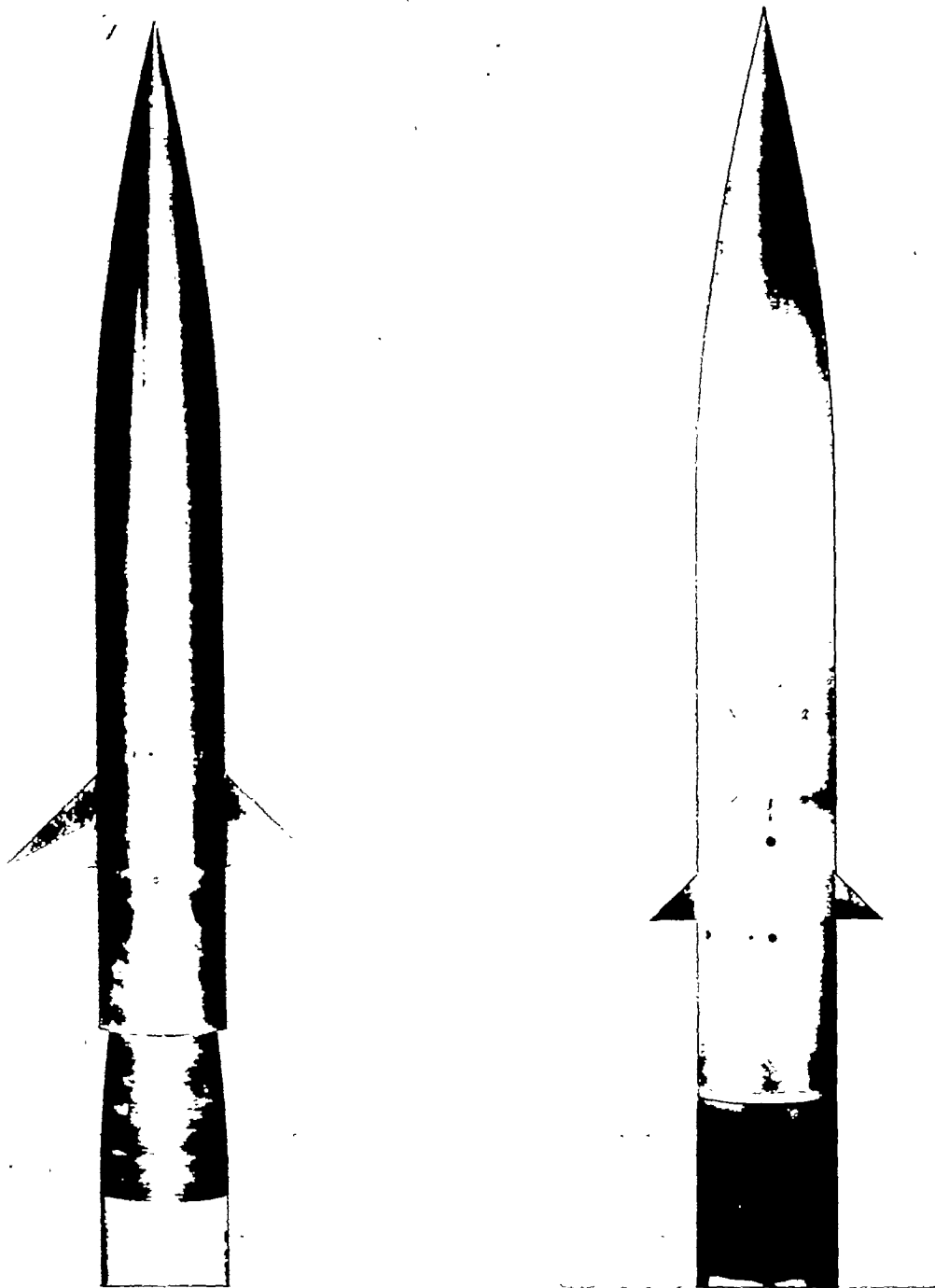

L-75103

(b) Configuration 2.

(c) Configuration 3.

Figure 1.- Concluded.

~~CONFIDENTIAL~~

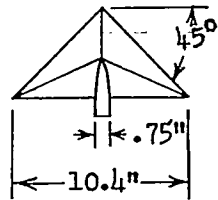

Configuration 1

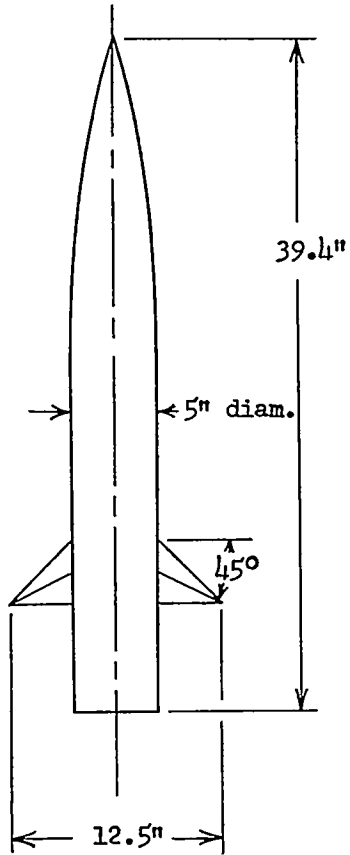

Configuration 2

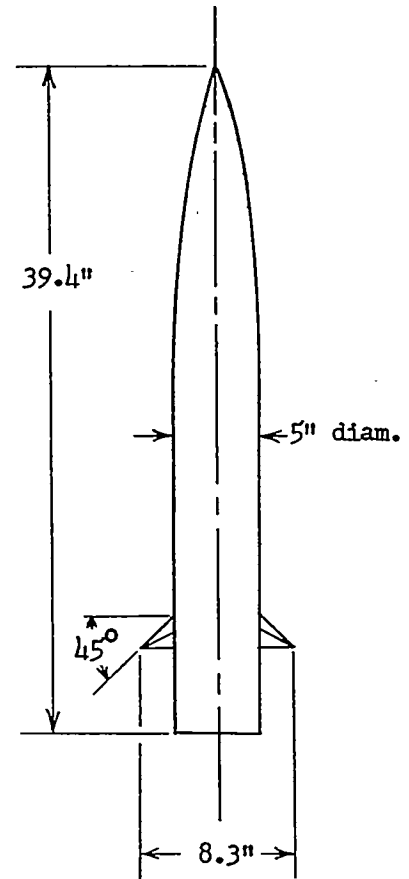

Configuration 3

Configuration	S	d/b	Reynolds number range
1	0.188	0	1.4 to 5.1×10^6
2	.271	0.4	1.5 to 5.2×10^6
3	.120	.6	.9 to 3.6×10^6

Figure 2.- Geometric details of configurations tested.



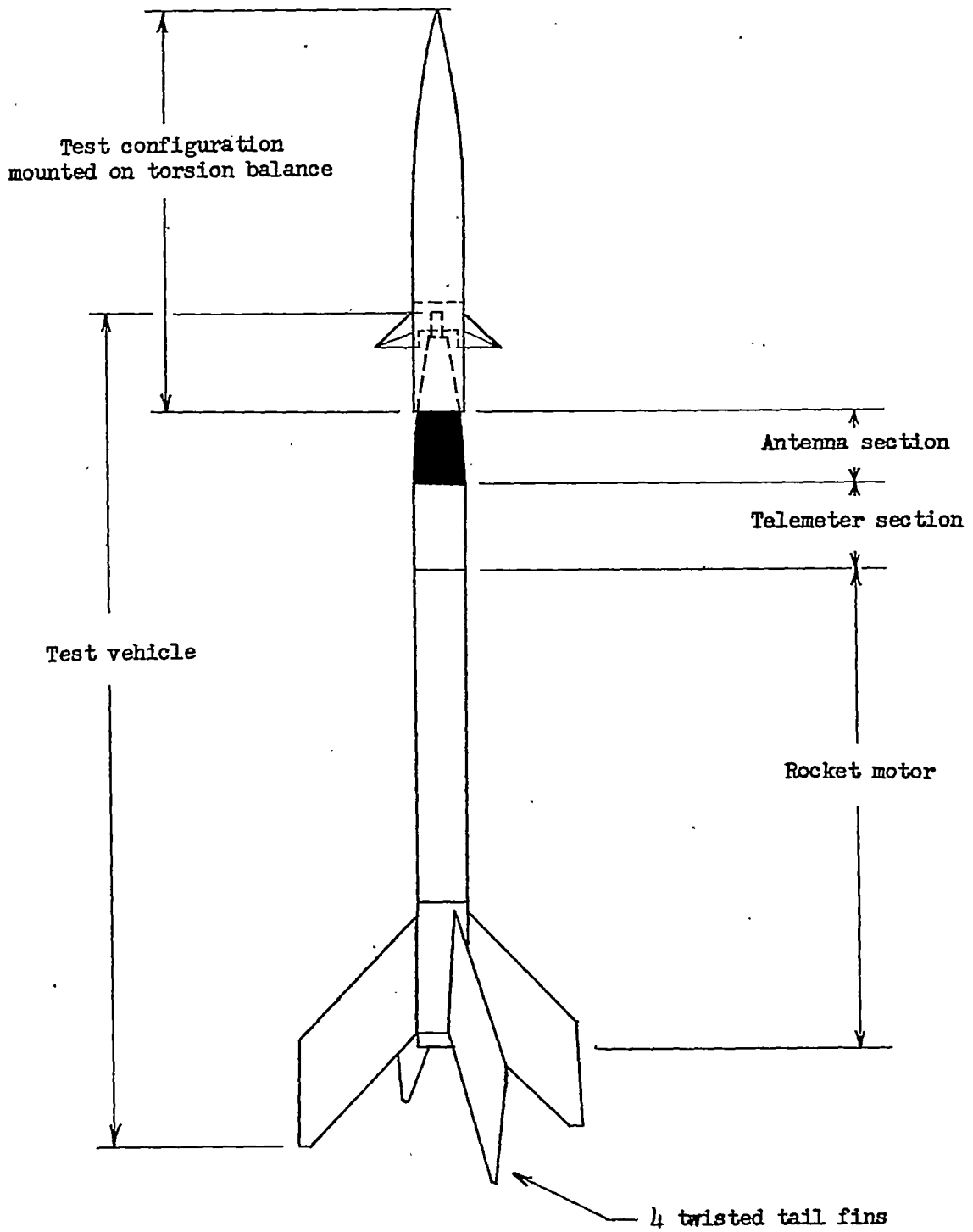

Figure 3.- Test configuration mounted on test vehicle.



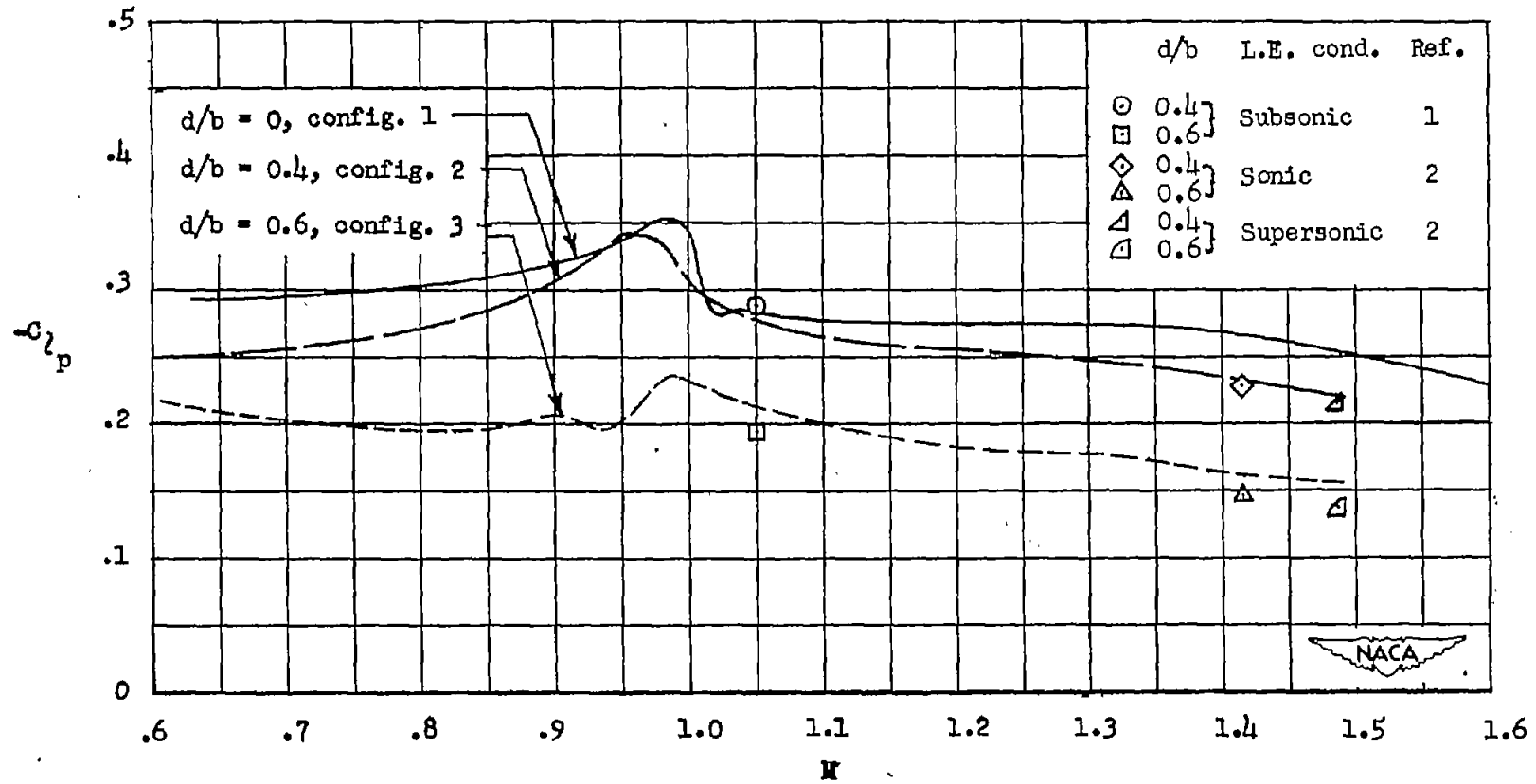
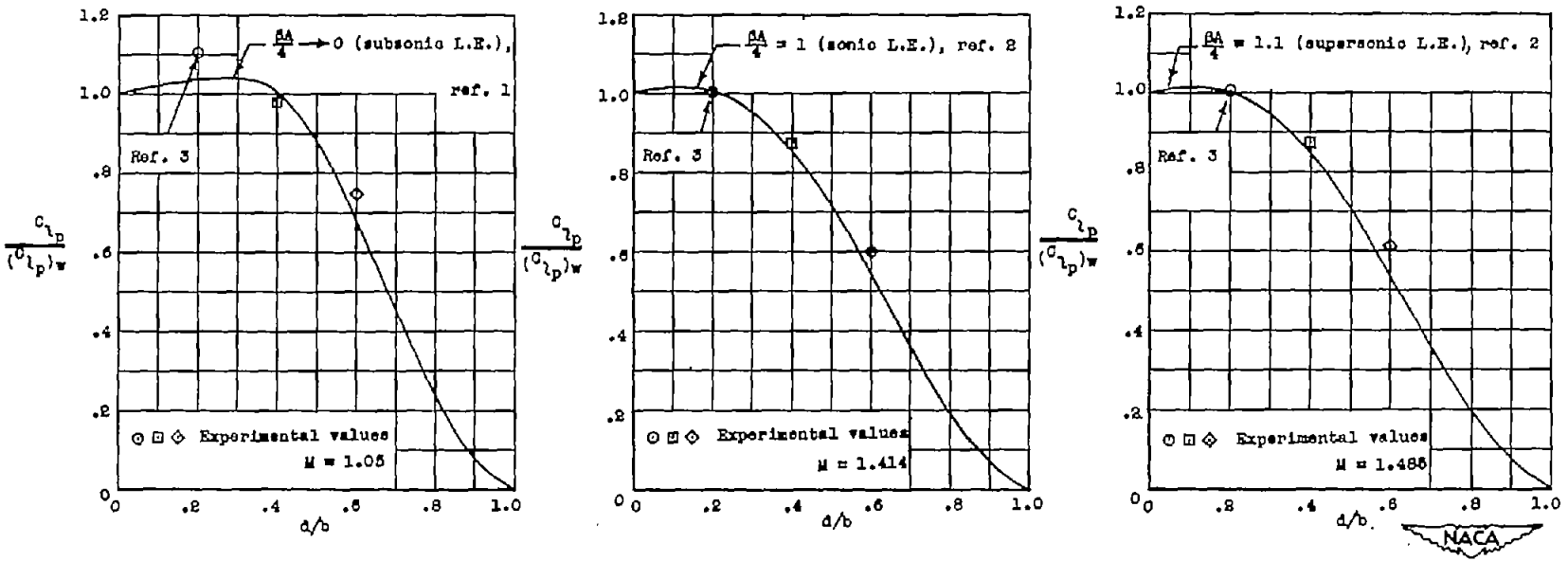

Figure 4.- Effect of fuselage-diameter - wing-span ratio on the variation of the damping-in-roll coefficient with Mach number.

NACA Langley - 7-18-53 - 350

CONFIDENTIAL



(a) Subsonic wing leading edges. (b) Sonic wing leading edges. (c) Supersonic wing leading edges.

Figure 5.- Comparison of experimental and theoretical values showing the relative effect on C_{Lp} of the fuselage-diameter - wing-span ratio.