

NACA RM L50L27

7231

NACA

TECH LIBRARY KAFB, NM
0143742

RESEARCH MEMORANDUM

FLIGHT PERFORMANCE OF A TWIN-ENGINE SUPERSONIC RAM

JET FROM 2,300 TO 67,200 FEET ALTITUDE

By H. Rudolph Dettwyler and Aleck C. Bond

Langley Aeronautical Laboratory
Langley Field, Va. (Unclassified)

Nasa Tech Pub Announcement #123
7 Jan 58

GRADE OF OFFICER MAKING CHANGE)

29 Mar 61
DATE

NATIONAL ADVISORY COMMITTEE FOR AERONAUTICS

WASHINGTON
February 19, 1951



NACA RM L50L27

NATIONAL ADVISORY COMMITTEE FOR AERONAUTICS

RESEARCH MEMORANDUM

FLIGHT PERFORMANCE OF A TWIN-ENGINE SUPERSONIC RAM

JET FROM 2,300 TO 67,200 FEET ALTITUDE

By H. Rudolph Dettwyler and Aleck C. Bond

SUMMARY

A flight investigation has been made of a ground-launched supersonic twin ram-jet test vehicle using short flame-length burners. The test demonstrated a maximum acceleration of 4.13g and a maximum flight Mach number of 3.12. Ram-jet performance data were obtained over a Mach number range of 1.80 to 3.12 and an altitude range from 2,300 to 67,200 feet, with a computed fuel-air-ratio range from 0.0245 to 0.0463. Thrust exceeded drag up to an altitude of 64,500 feet. Ram-jet burnout occurred at a Mach number of 2.92, a fuel-air ratio of 0.0245, and 67,200 feet altitude. A maximum thrust coefficient of 0.885 was obtained at a flight Mach number of 2.10. During the flight test, the vehicle coasted to a peak altitude of 159,000 feet.

INTRODUCTION

Results from the initial flight test of a twin-engine supersonic ram jet were reported in reference 1. The test vehicle in the initial test was launched at an elevation angle of 45° and flew along a zero-lift trajectory. Ram-jet performance data were obtained up to an altitude of 40,900 feet.

A second ram-jet test vehicle has been flown along a zero-lift trajectory with the launching angle increased to 75° in order to obtain ram-jet performance data over a higher altitude range than that obtained in the initial flight test. In addition to increasing the altitude range, this flight test differed from the first in that the ram jets were equipped with somewhat different diffusers and exit nozzles. The present engine had a design Mach number of 2.1, which was the same as that in the initial flight, but the diffuser entrance area was 25 percent larger and the exit-nozzle contraction ratio was 9 percent larger. These changes were incorporated in order to achieve higher thrust coefficients with the

John Bond

~~0143742~~

same combustor and essentially the same fuel rates. The results of this high-altitude flight are presented in this paper.

APPARATUS AND TEST

Test Vehicle

The test vehicle with twin ram jets installed on the tail surfaces and the double-rocket booster unit used for launching is shown in the launching attitude in figure 1. With the exception of the ram-jet diffusers and exit nozzles, the test vehicle and the booster unit were similar to those described in reference 1.

The principal dimensions and general arrangement of the test vehicle are shown in figure 2. The vehicle was 15 feet $9\frac{1}{2}$ inches long and weighed 241.5 pounds, including 25 pounds of fuel. The twin ram jets were mounted symmetrically on the horizontal fin 8.55 inches from the vehicle center line. The fuselage of the vehicle was compartmented from front to rear as follows: telemeter nose antenna, telemeter section, telemeter and fuel-control power section, fuel tank, fuel-control section, telemeter-pressure-cell section, and booster-unit adapter.

Ram-Jet Engines

The two identical ram-jet engines which were mounted on the horizontal tail surfaces were 6.6 inches in diameter, 47.2 inches long, and weighed 34.5 pounds each. Each engine had an inlet diffuser of the Ferri type with a diffuser-entrance-area to combustion-chamber-area ratio of 0.465 and a design Mach number of 2.1. The engines used fuel-cooled, short flame-length "donut" burners which are completely described in reference 1. The exit nozzle had a contraction ratio of 0.853 and an expansion ratio of 0.826. A sectional view of the engine showing component parts is given in figure 3 and coordinates of the inner body are given in table I.

Ignition of the engines was accomplished by means of a starting disk and two electric-delay squibs in each engine after take-off. The fuel used was ethylene (C_2H_4) and the fuel system was similar to that used in the initial flight test. The fuel flow was regulated at a predetermined rate by a motorized needle valve. This valve also synchronized the fuel flow with the time of take-off and ignition of the squibs in ram-jet engines.

Instrumentation

Continuous-wave Doppler radar near the launching site was used to measure velocity of the test vehicle for the first 13.5 seconds of the flight. The flight path of the vehicle was obtained by NACA modified SCR584 tracking radar during the first 34 seconds of the flight.

An NACA six-channel telemeter measured free-stream pitot stagnation pressure, longitudinal acceleration, and engine static pressures at the points shown in figure 3. In addition, the right combustion-chamber-exit pressure channel was interrupted by a revolution counter on the fuel metering valve in order to determine whether the valve functioned as prescribed by ground tests. The telemeter recorded data throughout the flight to impact (265 sec after take-off).

Immediately after take-off, a balloon carrying a radiosonde was released to obtain atmospheric conditions.

Flight Test

Flight test of the vehicle was conducted at the Pilotless Aircraft Research Station at Wallops Island, Va. The vehicle was launched at a 75° elevation angle and was accelerated to $M = 1.80$ by the booster. Ignition of the ram jets occurred at 2.34 seconds after take-off at $M = 1.33$. Booster separation occurred at 3 seconds, and, during the next 17.75 seconds, the test vehicle accelerated to a velocity of 2,967 feet per second corresponding to a peak Mach number of 3.12. During this time, a maximum acceleration of 4.13g was recorded. Combustion was sustained to an altitude of 67,200 feet. Burnout occurred at 28.3 and 29.5 seconds for the right and left engines, respectively, because of the lean limit of the burners, which is influenced by a combination of low fuel flow and combustion-chamber static pressure and velocity. The vehicle then coasted to a peak altitude near 159,000 feet and to an estimated impact horizontal range of 40 miles. A trajectory of the flight is presented in figure 4 up to a time of 156 seconds. The trajectory was not extended beyond this point because of the erratic nature of the accelerometer data obtained in the interval from 156 to 172 seconds. The time of impact, 265 seconds, was indicated on the telemeter record by a complete loss of signal at that time.

The erratic accelerations beginning at 156 seconds and an altitude of 115,000 feet indicate that the vehicle was experiencing erratic changes in flight attitude. At the peak altitude of 159,000 feet the velocity and dynamic pressure were approximately 1,020 feet per second and 1.3 pounds per square foot, respectively. The erratic accelerations were due presumably to the vehicle's inability to weathercock at the extremely low dynamic pressures encountered at the high altitudes and

to oscillations about its mean position as it rapidly regained ability to weathercock in the neighborhood of 115,000 feet altitude.

Prior to take-off, a leak was detected in the fuel system; however, it was felt that the ability of the ram-jet engines to propel the vehicle to high altitude and high Mach number would not be adversely affected if some fuel was lost. Therefore, the test vehicle was launched with a fuel load somewhat less than the intended 25 pounds.

ANALYSIS OF DATA AND DISCUSSION

The accelerometer data were used to determine the flight path and velocity time history of the vehicle beyond the ranges of tracking radars. Total-pressure data, together with atmospheric data obtained from the radiosonde, were used to determine the velocity independently. Figure 5 shows a time history of the flight Mach number determined by three methods: (1) Doppler radar extended by integration of the accelerometer data, (2) differentiation of SCR584 radar data, and (3) the use of total-pressure and atmospheric data. Good agreement is shown between the three methods up to about 20 seconds, at which time method (3) begins to show disagreement with the other two. This disagreement is believed to be due to the effect of a temperature rise in the order of 400° F due to aerodynamic heating of the skin surrounding an uninsulated pressure cell above a sustained Mach number of 2.0 for 13 seconds. Instrument checks in this temperature region indicated higher pressure readings than under normal ambient conditions. The Mach number determined by the Doppler radar and accelerometer is considered to be the most accurate and was therefore used in the performance computations. Figure 6 presents the atmospheric temperature and pressure encountered by the vehicle corresponding to the burning part of flight. The readings of the longitudinal acceleration recorded during the burning part of the flight are presented in figure 7 and indicate that both engines were up to operating conditions by 4 seconds. Positive acceleration was sustained to 28.3 seconds.

A time history of the static pressures measured in the engines is presented in figure 8. Ignition and burnout times of both ram-jet engines are clearly noted by definite pressure changes. The starting disk was located between the two static-pressure orifices. Therefore, as the starting disk burned away, diffuser exit pressure dropped and combustion-chamber exit pressure increased. These pressures indicate that the disk was completely burned out at 4 seconds. Part of the telemeter record showing take-off time, ram-jet ignition, booster separation, and burnout is shown in figure 9.

The diffuser total-pressure recovery calculated from the diffuser exit static pressures and the free-stream conditions is shown in figure 10. The low diffuser recoveries above the design Mach number of 2.13 indicate that the ram jets were not operating at maximum thrust conditions. Greater recoveries would have been obtained if the fuel-air ratios had been greater or if the combustion-chamber exit nozzles had smaller throats. Ground-test experience determined the diffuser pressure recovery at which violent buzz occurred for any combination of fuel rates and exit nozzles. Thus, diffuser recovery was essentially determined prior to the flight test by the nozzle-contraction ratio chosen and by the fuel rates selected in order not to experience any violent diffuser buzz during the part of the flight below the inlet design Mach number.

The inlet of the ram jet tested had a 25-percent-larger area than the inlet employed in the initial flight test. The design combustion-chamber entrance velocity of this inlet was calculated to be 250 feet per second at stoichiometric fuel-air ratio, as compared to 200 feet per second in the initial flight test. The computed combustion-chamber entrance velocity as a function of flight Mach number is presented in figure 11 over the range of fuel-air ratios encountered. The combustion-chamber entrance velocity ranged from 266 feet per second to 360 feet per second with a maximum at burnout. Combustion-chamber static-pressure traces indicated smooth and stable combustion over the ranges of burner velocity computed. This flight test demonstrated that combustion was sustained at higher chamber velocities and showed that it is not necessary to increase the combustion-chamber cross-section area or redesign the burner for this change in inlet area.

The net thrust, defined as the actual net propulsive force, was determined from the longitudinal acceleration shown in figure 7 and the vehicle mass corrected for fuel consumption. Net thrust coefficients were then determined using atmospheric conditions shown in figure 6. For performance evaluation, the external drag of the vehicle was assumed to be the same as the external drag of the test vehicle reported in reference 1. The external drag coefficients reported in that reference were used because the drag coefficients derived from this flight were not of sufficient accuracy. Since drag data could be obtained only after burnout, the drag forces were small because of the low dynamic pressures encountered at the high altitudes and, hence, would have involved the use of accelerometer readings less than 1 percent of full-scale deflection.

The external drag coefficient at the various Mach numbers was then added to the net thrust coefficient to give internal (net) thrust coefficient. In this paper internal (net) thrust coefficient is designated as gross thrust coefficient. The net thrust coefficient, external drag coefficient, and gross thrust coefficient based on fuselage frontal area are presented in figure 12 as a function of Mach number.

The over-all engine performance was evaluated by determining the total engine impulse and total fuel required, complete heat release from the fuel being assumed. These values were compared with actual fuel consumption to determine over-all fuel specific impulse and over-all combustion efficiency. From the various values of gross thrust coefficient, Mach number, and free-stream temperatures throughout the burning part of flight, fuel-air ratios were calculated, complete heat release being assumed. The method employed here is presented in the appendix of reference 2. The gross thrust coefficient, based on combustion-chamber cross-sectional areas and the calculated fuel-air ratio, are presented in figure 13 as a function of flight Mach number. A maximum thrust coefficient of 0.885 at a Mach number of 2.10 was obtained. The curves reverse after $M = 3.12$ because of the decrease in flight speed while the engines were operating at decreased thrust. The maximum calculated fuel-air ratio was 0.0463 at $M = 2.60$ and the minimum fuel-air ratio of 0.0245 was obtained at burnout $M = 2.92$.

The gross thrust, calculated fuel rate, and the fuel rate determined from ground tests are plotted as a function of flight time in figure 14. Integration of the ground-test fuel rate from 3.5 to 29.5 seconds showed a total fuel consumption of 23.8 pounds, whereas integration of the calculated fuel rate, assuming complete heat release over the same period, showed 15.5 pounds of fuel consumed. The ratio of fuel consumption calculated for complete heat release to fuel consumed by the engines gave an over-all combustion efficiency η_c of 65 percent.

A total impulse of 22,880 pound-seconds was obtained by integration of the thrust time curve of figure 14 between 3.5 and 29.5 seconds. By dividing the total impulse by 23.8 pounds of fuel (as determined by integration of the ground-test fuel rate) an over-all fuel specific impulse S_p of 961 seconds was obtained.

The values of combustion efficiency and impulse were obtained for the complete burning part of the flight and under conditions ranging from 2,300 to 67,200 feet altitude, Mach number from 1.80 to 3.12, and computed fuel-air ratios from 0.0245 to 0.0463.

As previously stated, the results indicated an over-all combustion efficiency of 65 percent and an over-all fuel specific impulse of 961 seconds. The methods used for computing combustion efficiency and fuel specific impulse require that the exact weight of fuel at take-off be known. Since there was a lapse of time between the time a leak was detected in the fuel system and the time of take-off, the exact weight of fuel was not known. Therefore, the values of combustion efficiency and fuel specific impulse should be considered as minimum values only. In comparison with the combustion efficiency of 81 percent and the fuel specific impulse of 1,059 seconds reported in the initial flight test,

the over-all performance of this flight should be approximately of the same order, except for any effects due to the increased altitude range and the change in engine geometry. The magnitude of these effects cannot be evaluated from the present flight test because of the fuel leak.

SUMMARY OF RESULTS

In this free-flight investigation of a ram-jet test vehicle, the following points were observed:

1. Both ram-jet engines operated satisfactorily over the following range of conditions: a computed fuel-air ratio (based on 100-percent heat release) range of 0.0245 to 0.0463, an altitude range from 2,300 to 67,200 feet, and a Mach number from 1.80 to 3.12.
2. Ram-jet ignition was satisfactorily accomplished by electric-delay squibs and a starting disk at a fuel-air ratio of 0.027 and $M = 1.33$ at 2,300 feet altitude.
3. A maximum thrust coefficient of 0.885 was achieved at $M = 2.10$ which was the design Mach number for the inlet.
4. A maximum longitudinal accelerometer reading of 4.13g was recorded.

National Advisory Committee for Aeronautics
Langley Aeronautical Laboratory
Langley Field, Va.

REFERENCES

1. Faget, Maxime A., and Dettwyler, H. Rudolph: Initial Flight Investigation of a Twin-Engine Supersonic Ram Jet. NACA RM L50H10, 1950.
2. Faget, Maxime A., Watson, Raymond S., and Bartlett, Walter A., Jr.: Free-Jet Tests of a 6.5-Inch-Diameter Ram-Jet Engine at Mach Numbers of 1.81 and 2.00. NACA RM L50L06, 1950.

TABLE I

INNER BODY COORDINATES

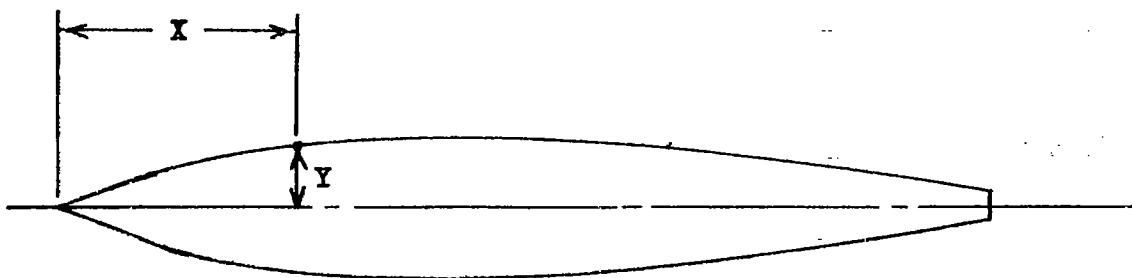

X	Y
0	0
3.500	1.272
3.600	1.316
3.700	1.338
3.800	1.356
3.900	1.376
4.000	1.390
4.120	1.400
4.620	1.438
5.120	1.468
5.620	1.490
6.120	1.504
6.620	1.510
7.000	1.510

X	Y
8.000	1.500
9.000	1.480
10.000	1.440
11.000	1.380
12.000	1.310
13.000	1.240
14.000	1.170
15.000	1.100
16.000	1.020
17.000	.930
18.000	.830
19.000	.720
20.000	.600
21.000	.470

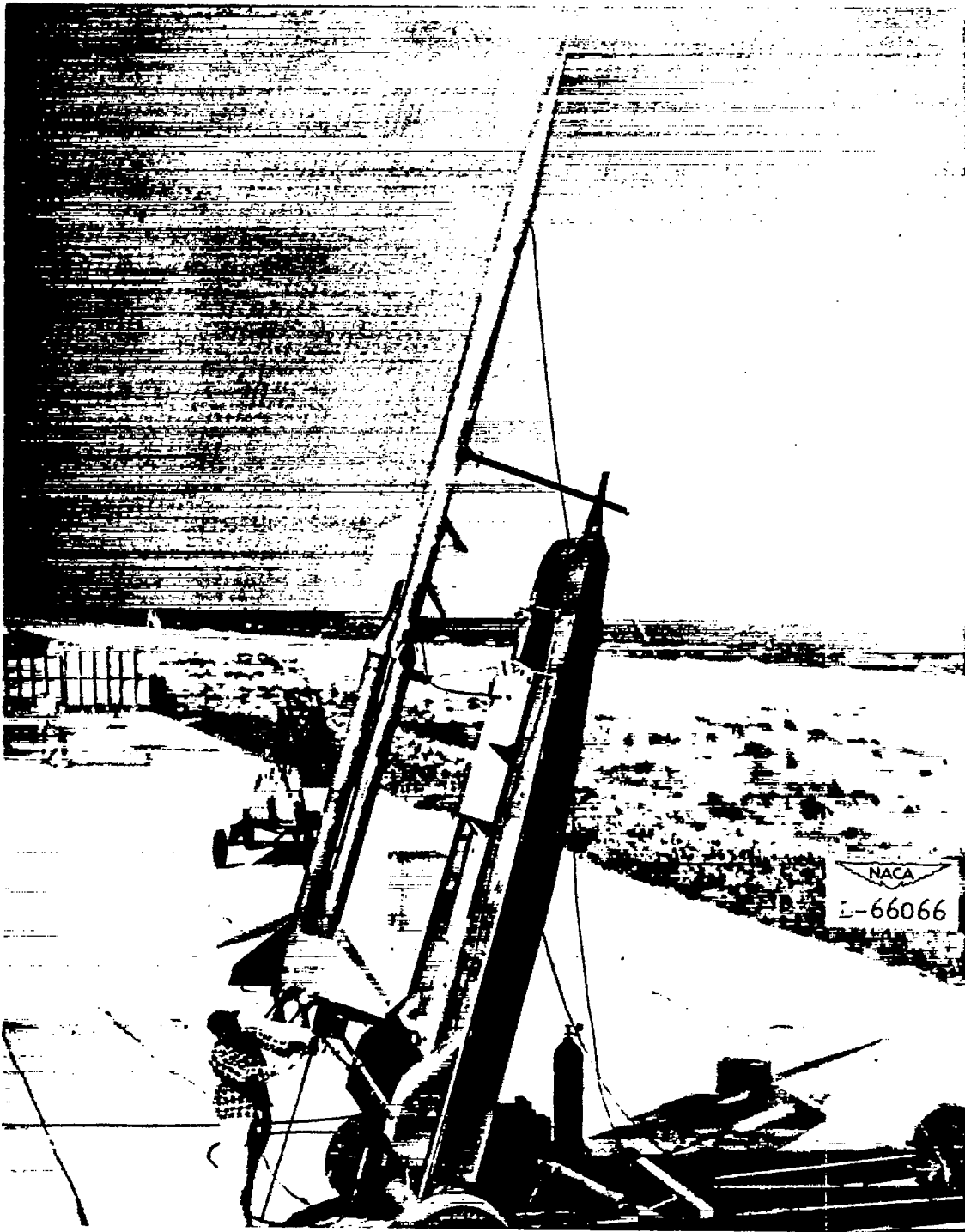

Figure 1.- Ram-jet test vehicle and double-rocket booster unit in launching attitude.

XXXXXXXXXXXXXXXXXXXX

XXXXXXXXXXXXXXXXXXXX

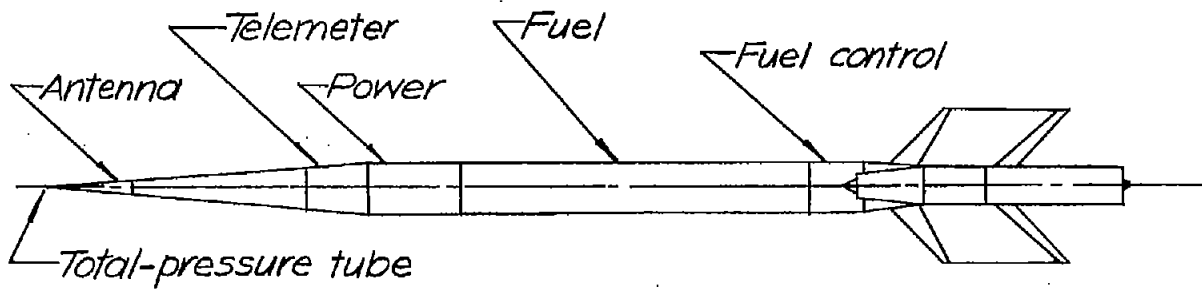
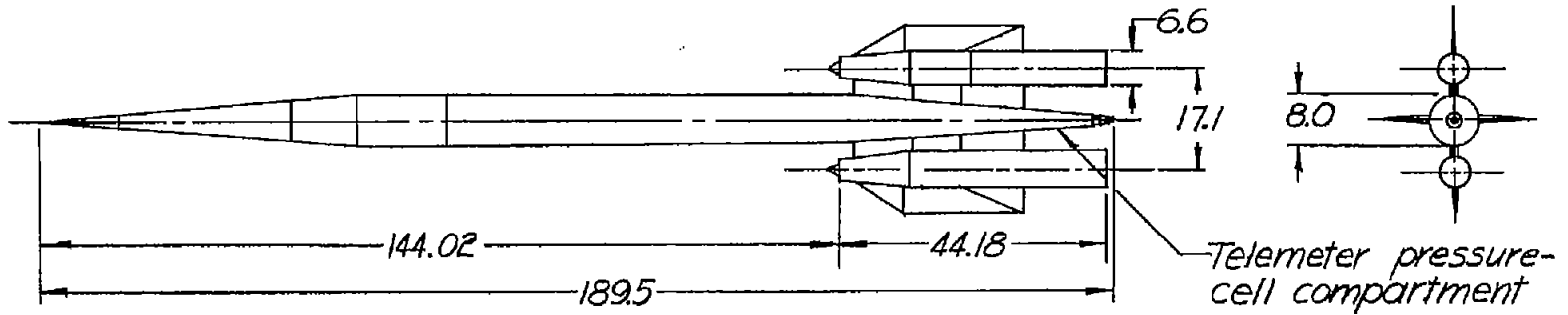

Figure 2.- General arrangement of test vehicle. All dimensions are in inches.

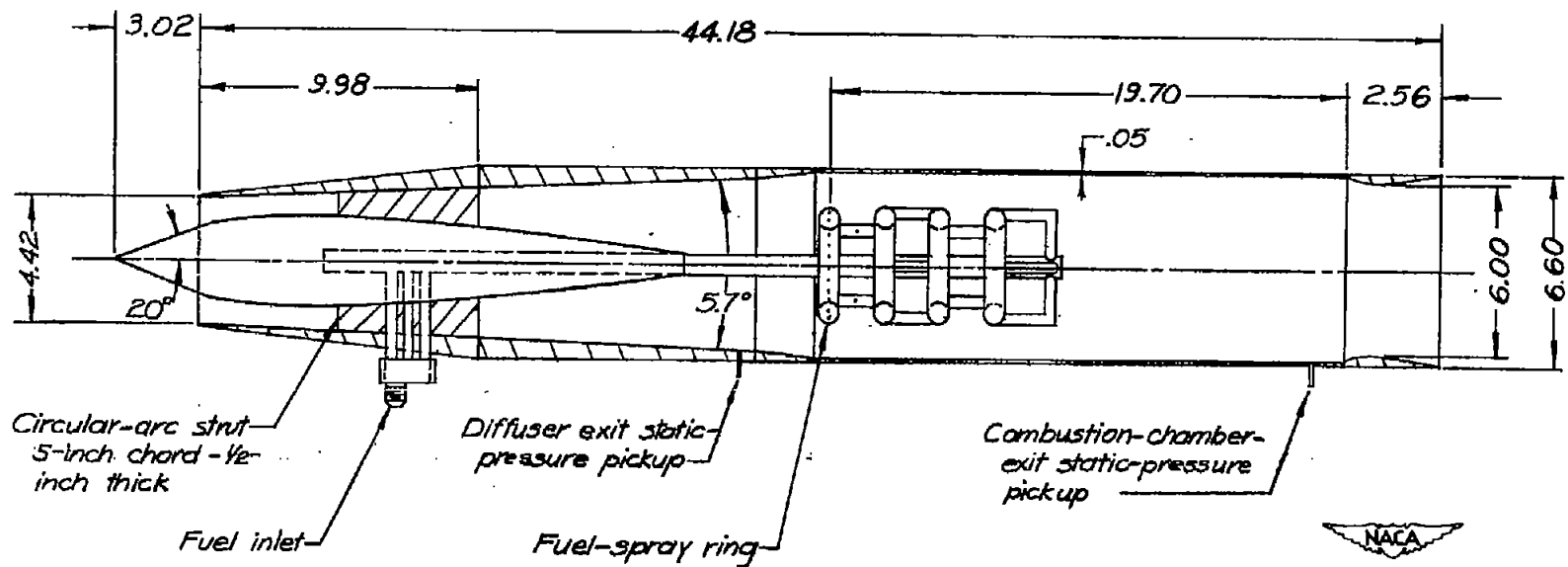

Figure 3.- Nacelle-type ram-jet engine tested. All dimensions are in inches.

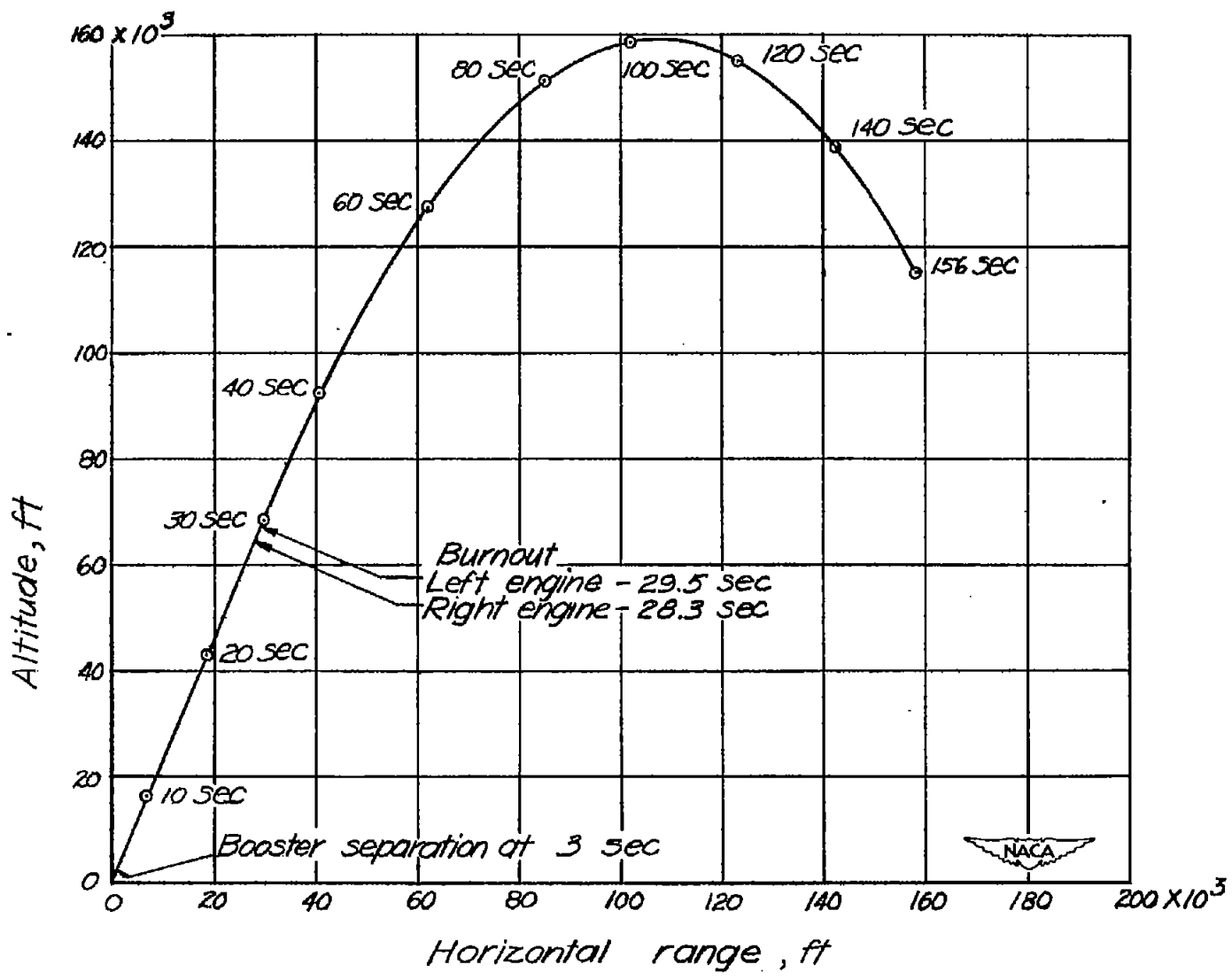

Figure 4.- Flight trajectory of test vehicle.

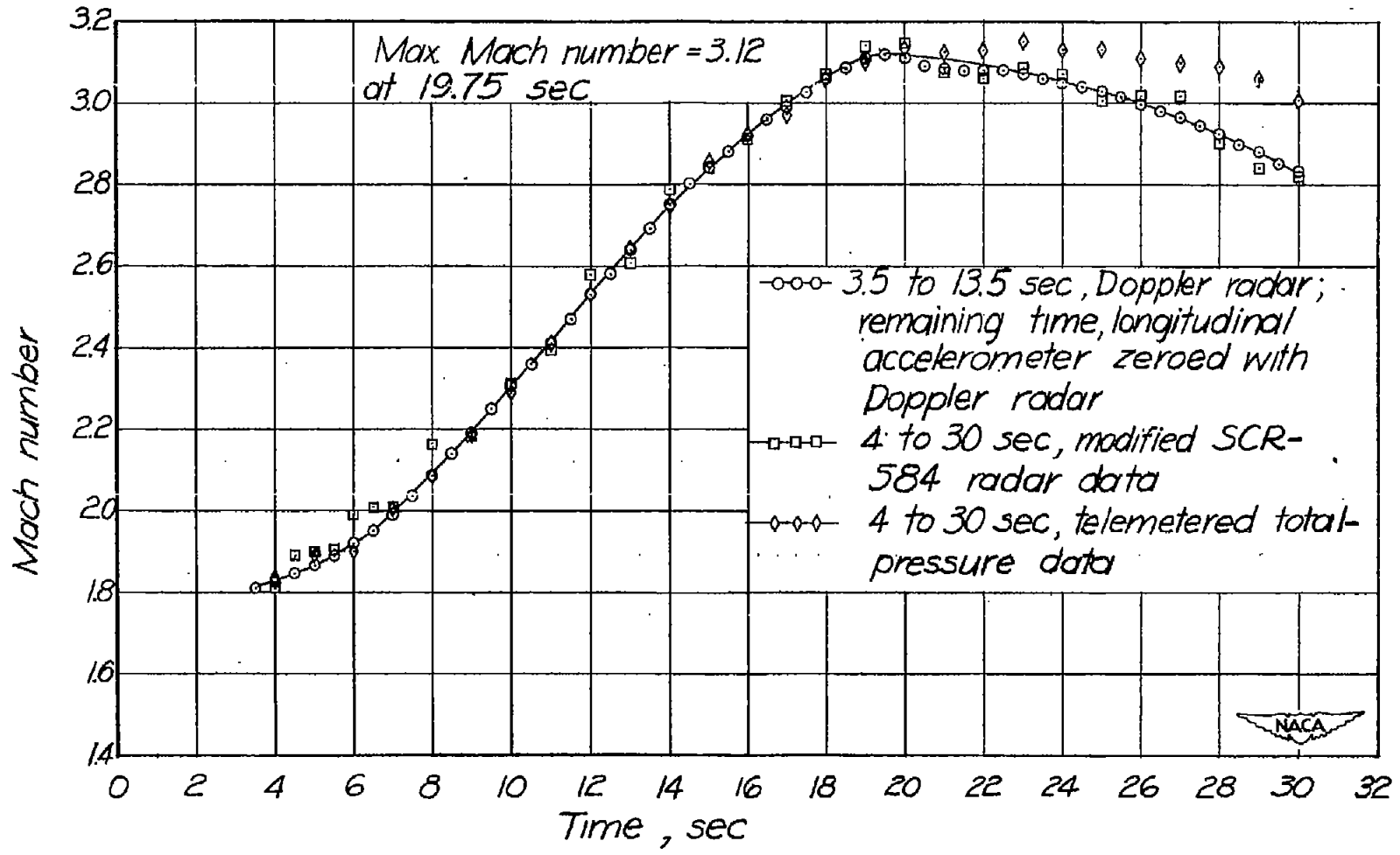

Figure 5.- Variation of flight Mach number with time.

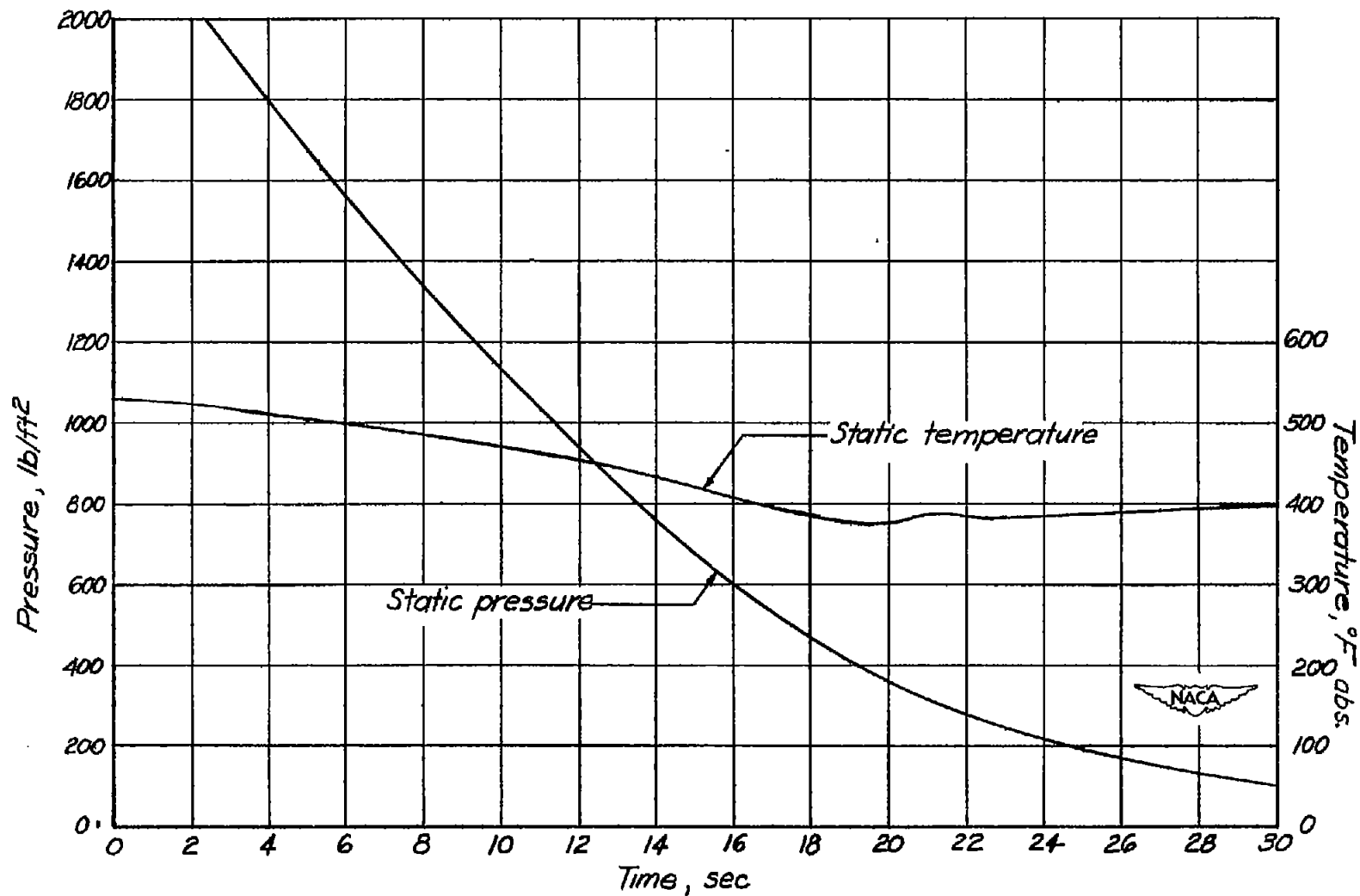

Figure 6.- Time history of atmospheric data.

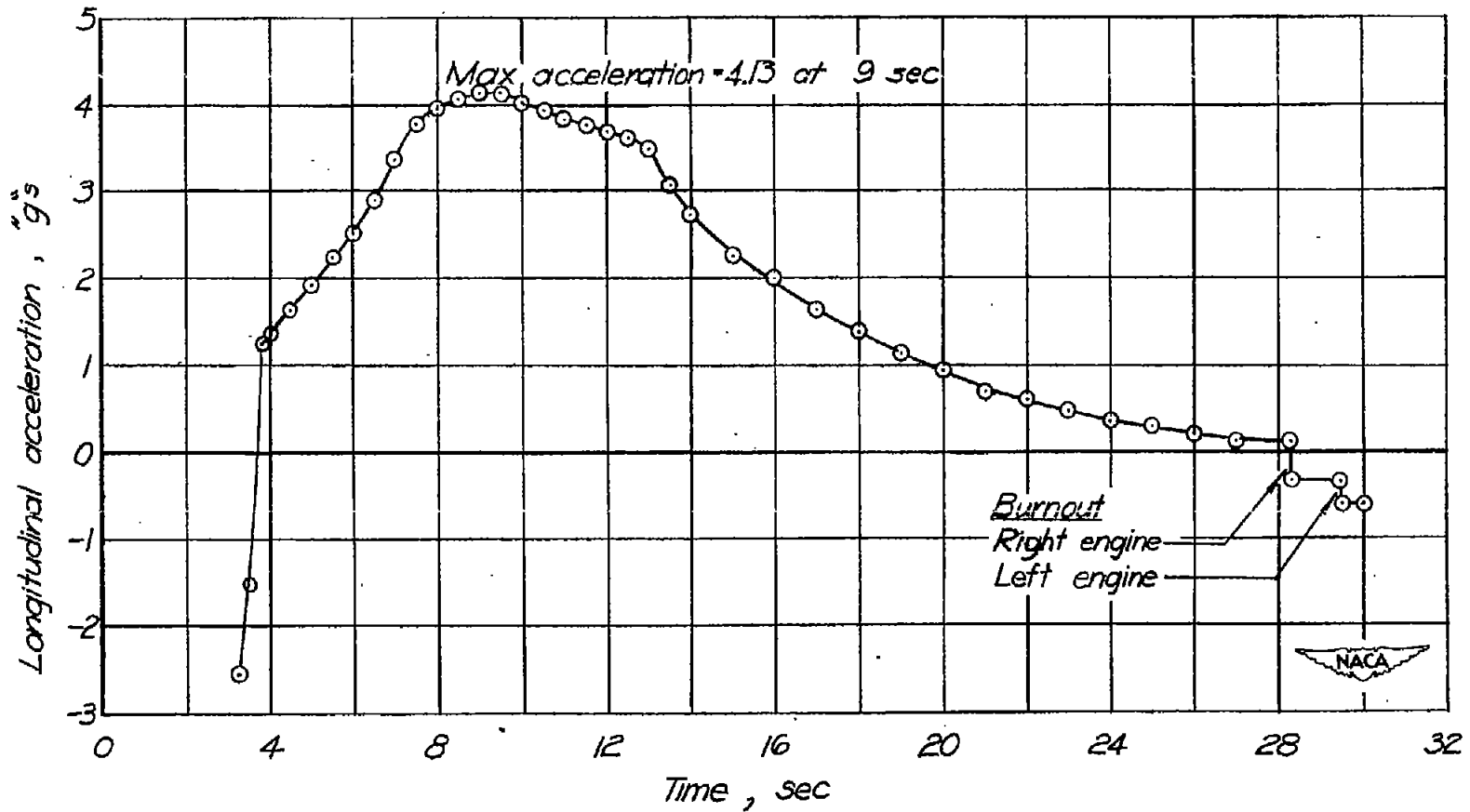

Figure 7.- Time history of longitudinal accelerometer reading during powered flight of ram-jet test vehicle.

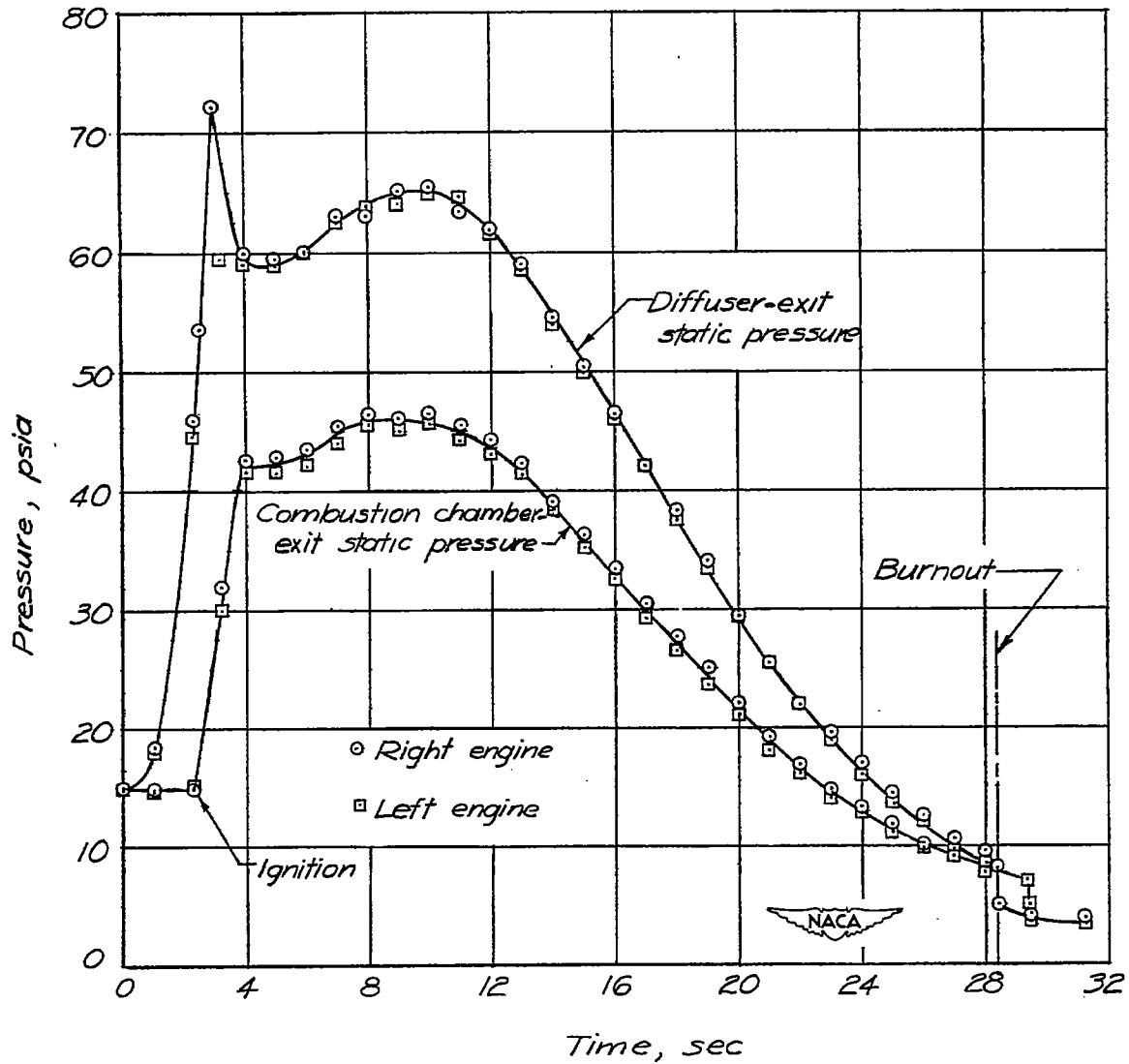

Figure 8.- Time history of engine static pressures.

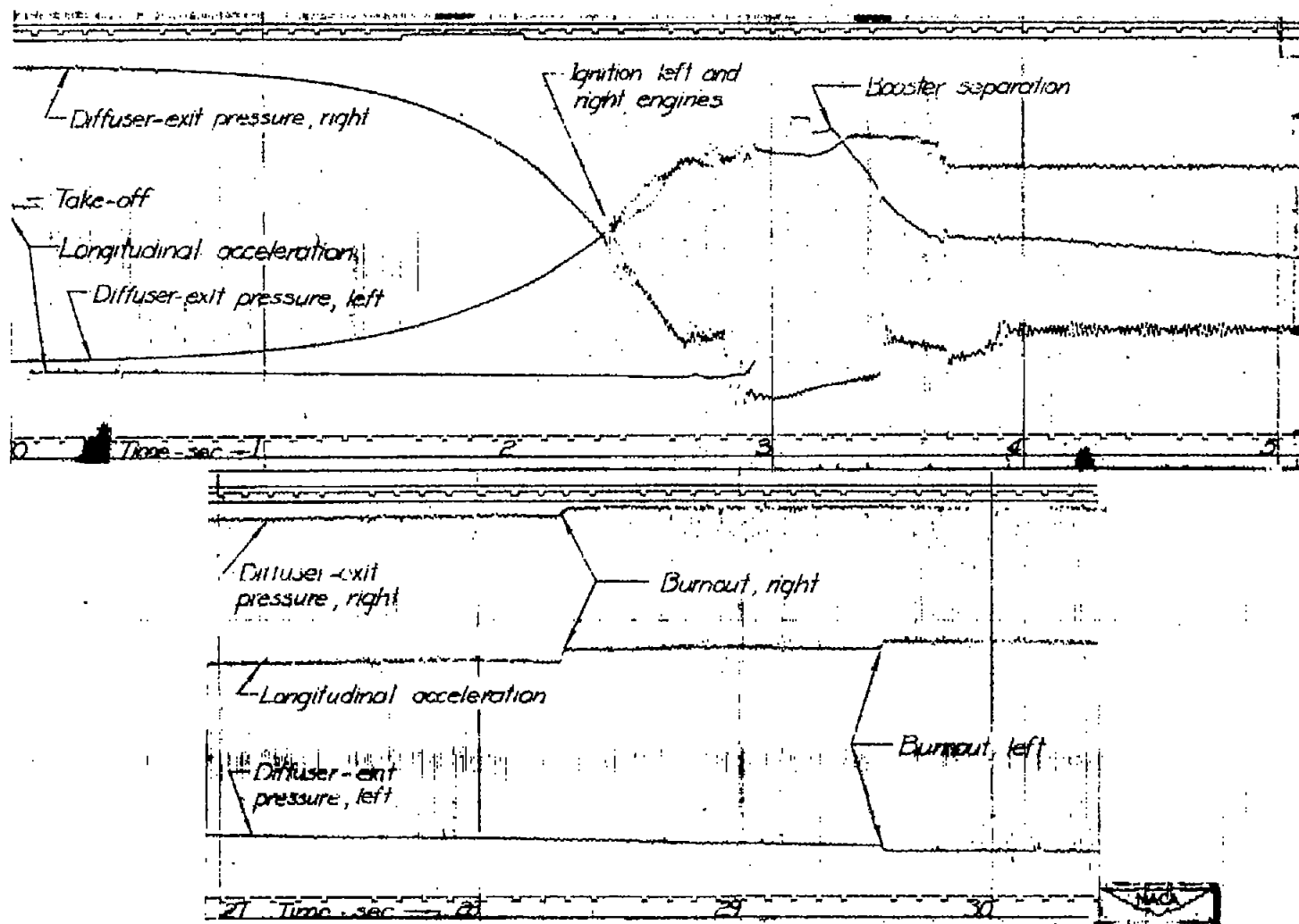

Figure 9.- Parts of telemeter record showing diffuser-exit pressure, left and right engines, and longitudinal acceleration during boost period and engine burnout.

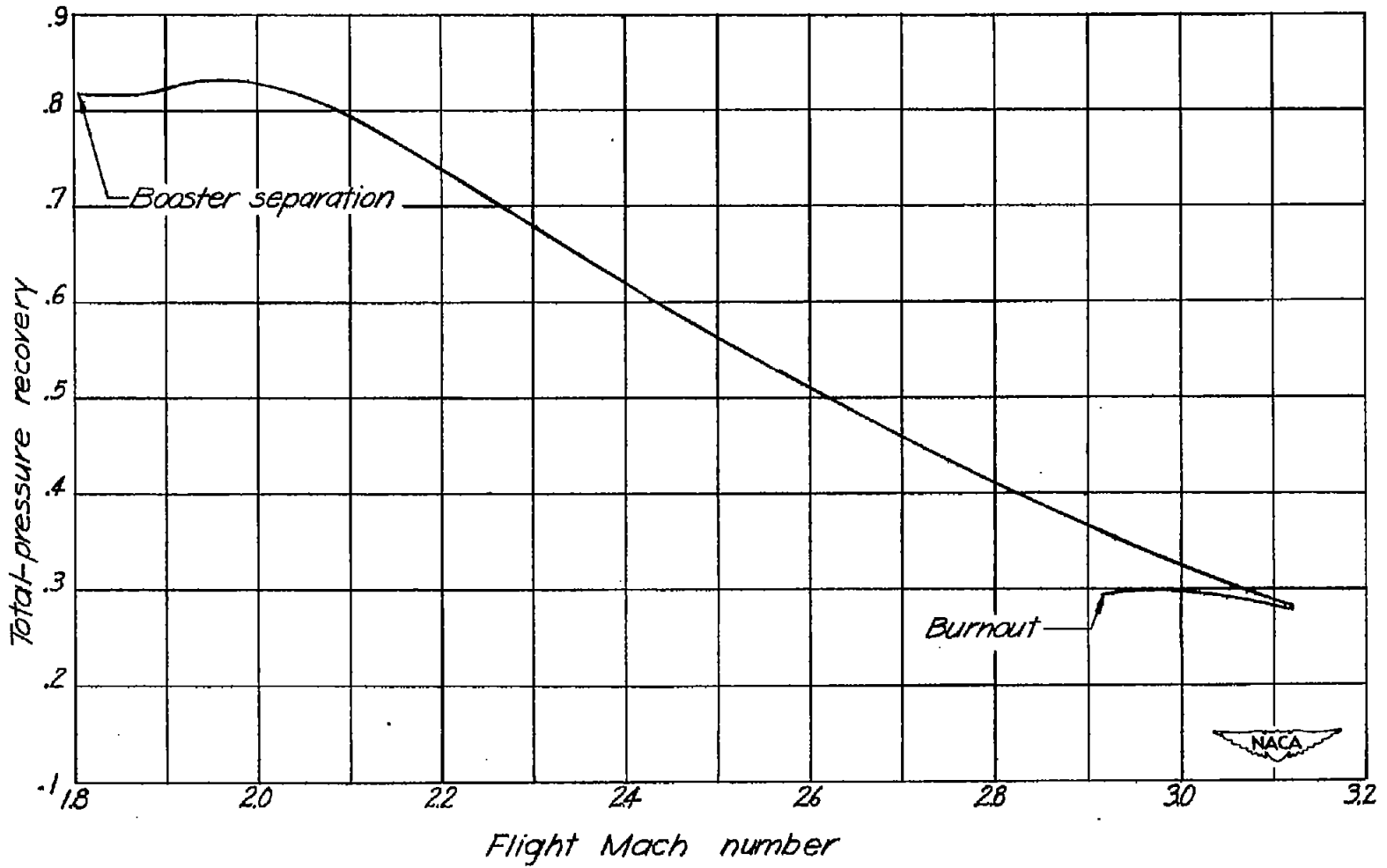

Figure 10.- Diffuser total-pressure recovery as a function of flight Mach number.

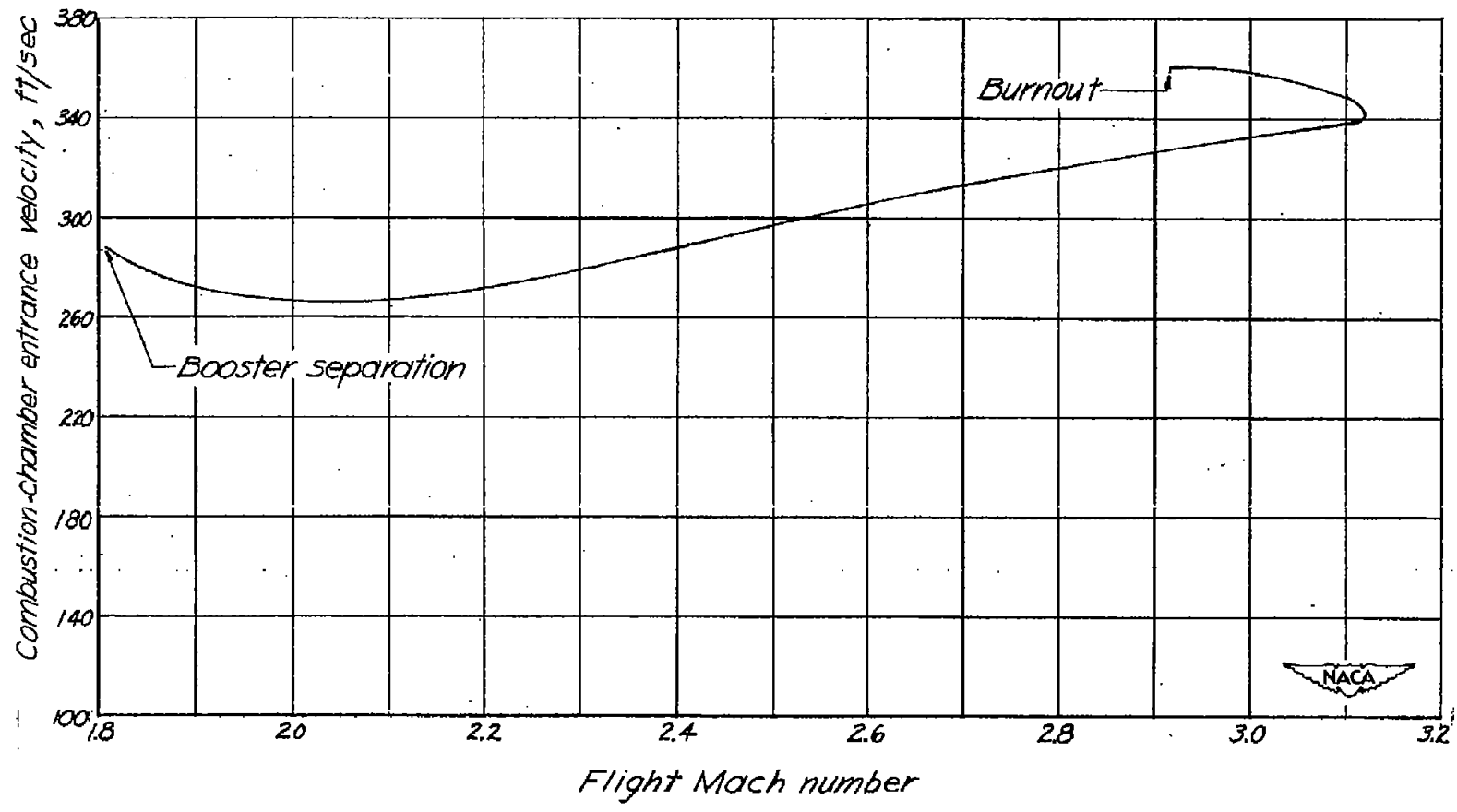

Figure 11.- Combustion-chamber entrance velocity as a function of flight Mach number.

CONFIDENTIAL

NACA RM 150127

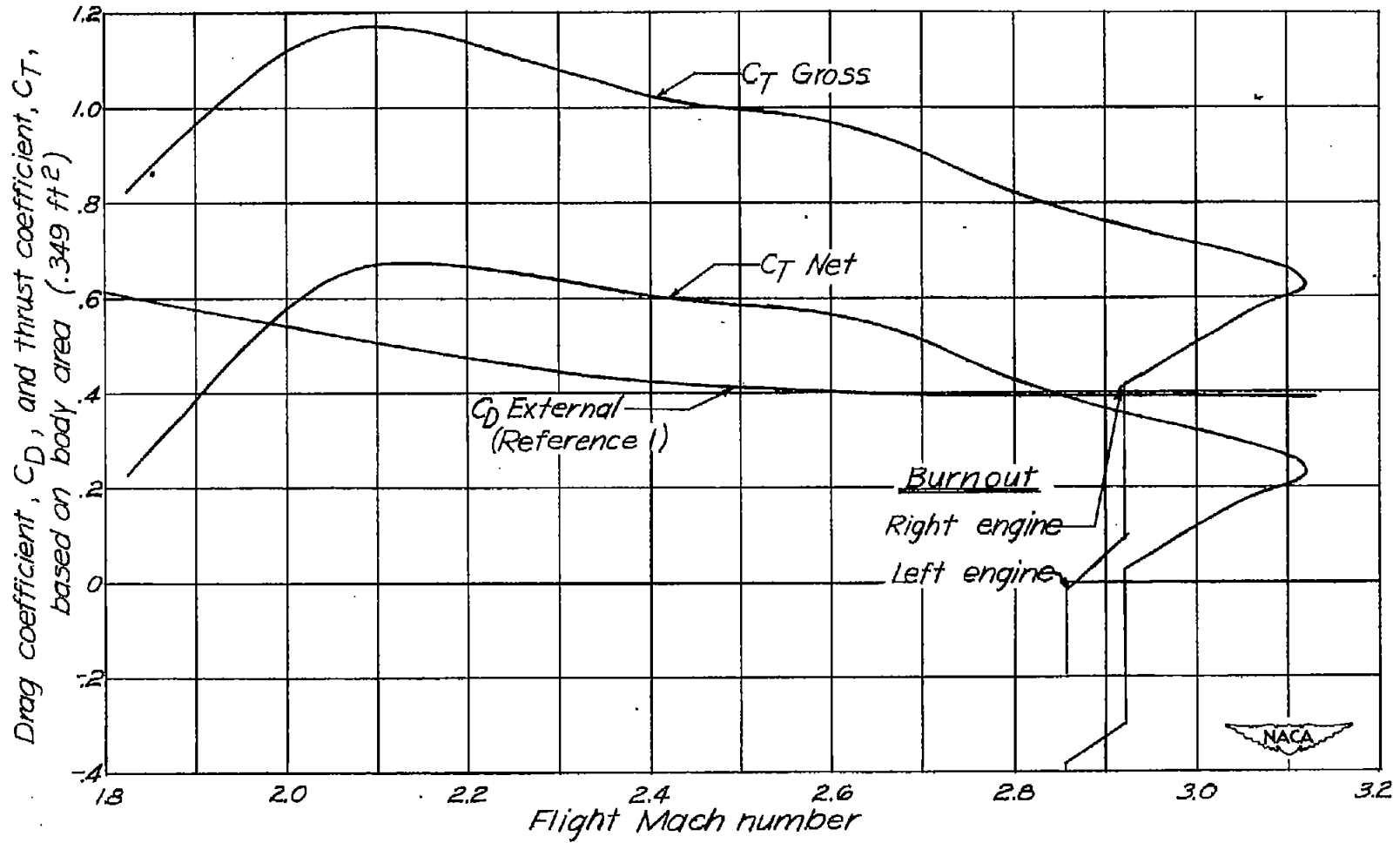

Figure 12.- Drag and thrust coefficient as a function of flight Mach number.

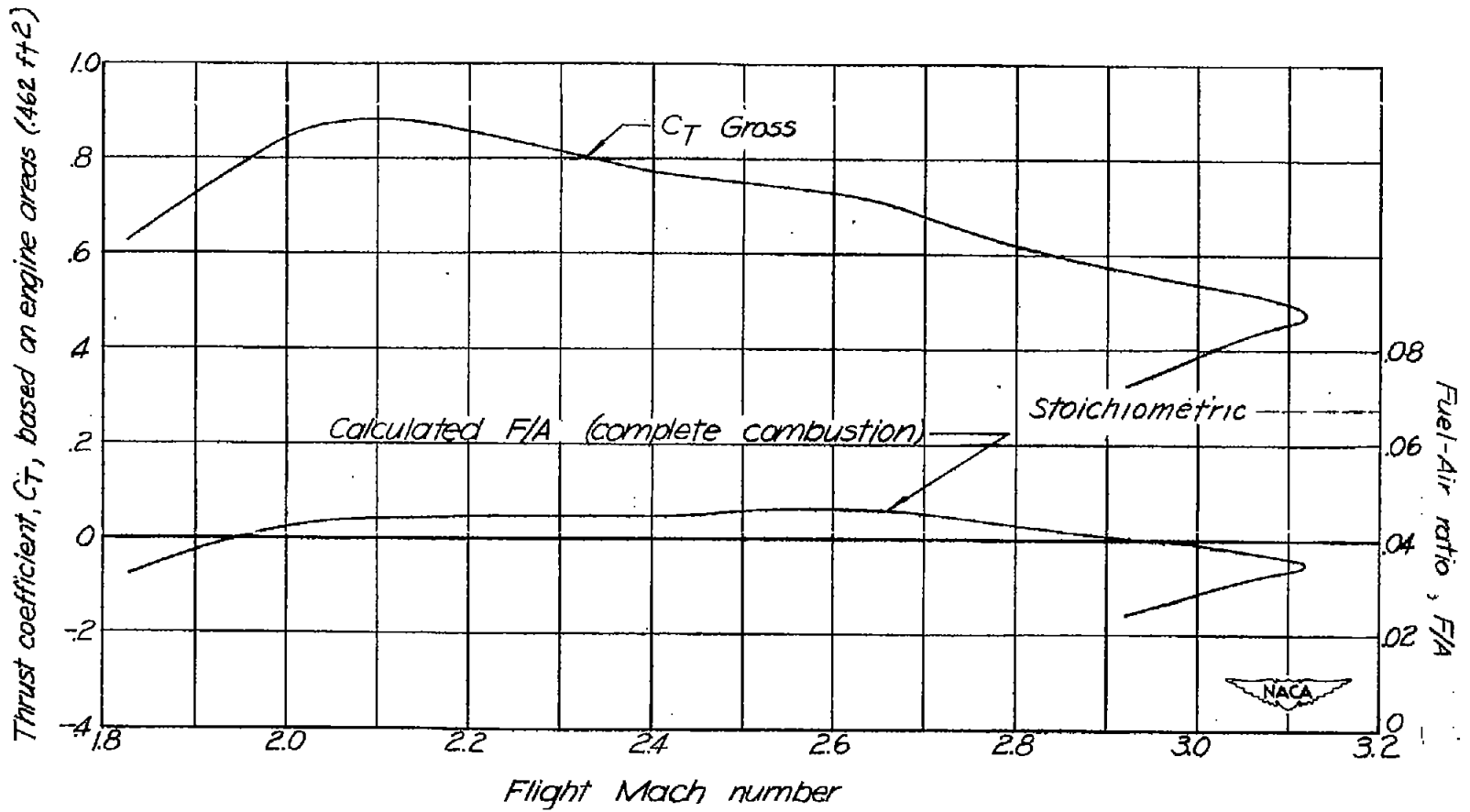

Figure 13.- Engine performance during flight.

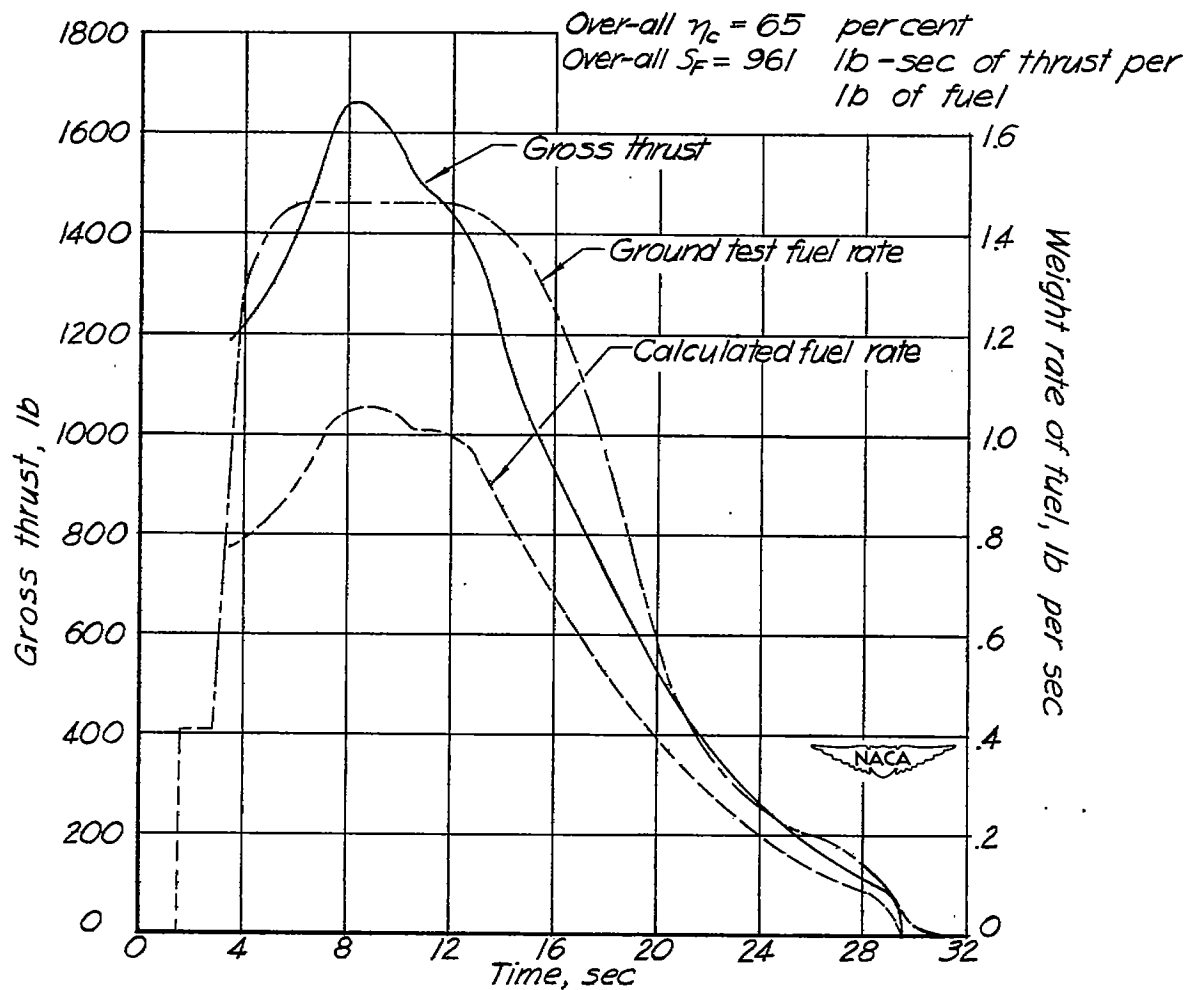

Figure 14.- Time history of total thrust and fuel consumption.