

NACA RM L50G31

7206

~~CONFIDENTIAL~~

NACA

TECH LIBRARY KAFB, NM  
0149814

# RESEARCH MEMORANDUM

FLIGHT INVESTIGATION AT MACH NUMBERS FROM 0.8 TO 1.4

TO DETERMINE THE ZERO-LIFT DRAG OF WINGS

WITH "M" AND "W" PLAN FORMS

By Ellis Katz, Edward T. Marley,  
and William B. Pepper

Langley Aeronautical Laboratory  
Langley Air Force Base, Va.

*Handwritten initials*

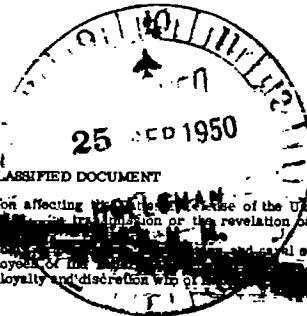

CLASSIFIED DOCUMENT

Information affecting the defense of the United States within the meaning of the Espionage Laws, Title 18, United States Code, Chapter 11, or the revelation of its contents in any manner to an unauthorized person by means of a communication, or the transmission of information so classified may be imputed to a person performing official or special services of the United States, appropriate civilian officers and employees of the Department of Defense, and a legitimate interest therein, and to United States citizens of known loyalty and discretion who are in contact with them.

## NATIONAL ADVISORY COMMITTEE FOR AERONAUTICS

WASHINGTON

September 18, 1950

~~CONFIDENTIAL~~

319.98/13

~~CONFIDENTIAL~~

Unclassified

By Authority: *NASA Tech Ops Announcement #749*  
(AUTHORIZED TO CHANGE)

By .. *29 Nov 56*  
*JK*

GRADE OF (MAKING CHANGE)

*4A on 6.1*  
DATE

FOR REPRODUCTION  
BY THE NATIONAL ARCHIVES

~~CONFIDENTIAL~~

## NATIONAL ADVISORY COMMITTEE FOR AERONAUTICS

## RESEARCH MEMORANDUM

FLIGHT INVESTIGATION AT MACH NUMBERS FROM 0.8 TO 1.4

TO DETERMINE THE ZERO-LIFT DRAG OF WINGS

WITH "M" AND "W" PLAN FORMS

By Ellis Katz, Edward T. Marley,  
and William B. Pepper

## SUMMARY

The zero-lift drag of two wings, one having  $45^\circ$  sweepforward of the inboard panel and  $45^\circ$  sweepback of the outboard panel ("M" wing) and the other having reverse panel sweep ("W" wing) have been measured in rocket model flight tests at Mach numbers from 0.8 to 1.4. An M-wing and a W-wing with an aspect ratio of 4 and a section thickness of 6 percent were flown and, in addition, an M-wing with attached nacelles and with an aspect ratio of 6 and a section thickness of 9 percent was flown. The results were compared with a rectangular and a fully sweptback wing and indicated that, in the transonic region, the M- and W-wings had greater drag than a sweptback wing and less drag than a roughly comparable rectangular wing. At slightly higher speeds (Mach number of 1.25), the M- and W-wings had less drag than an unswept wing and the same or less drag than the sweptback wing.

## INTRODUCTION

Analysis of wings which are practical for high-speed flight has shown that although swept wings generally have less drag than comparable straight wings, this advantage is offset to some extent by their lower structural rigidity. A preliminary study of a wing employing sweepback on the outer wing panels and sweepforward on the inner panels (an "M" plan form) or vice versa (a "W" plan form) has indicated that such a wing might reduce the aerodynamic-center shift resulting from twist due to bending which is an unfavorable characteristic of swept wings.

This paper presents results of rocket model flight tests made to determine the zero-lift drag of M- and W-wings through the range of transonic speeds. The wings tested had thicknesses of 6 and 9 percent

~~CONFIDENTIAL~~

0143814

for aspect ratios of 4 and 6, respectively. The results are compared with the zero-lift drag of stright and swept wings. Also included in this paper are the results of simple flexure tests on the subject wings and on fully sweptback wings.

The wing drag presented in this investigation is taken as the difference in the total drags of winged and wingless configurations and, therefore, includes interference effects. The Reynolds number range of the tests is from approximately  $2 \times 10^6$  to  $8 \times 10^6$  corresponding to a Mach number range from approximately 0.8 to 1.4.

### MODELS

The present test models had wings which are referred to as M, W, and sweptback plan forms. The M-wing is defined as having a plan form such that the outboard wing panels are swept back and the inboard panels are swept forward. The W-wing is defined as the reverse of the M plan form in that the inboard wing panels are swept back and the outboard panels are swept forward. The fully sweptback wing is swept back over the total span.

The sweep angle for the present test wings was  $\pm 45^\circ$  referred to the 25-percent-chord line. Two types of research configurations are reported for the present investigation. The first type, shown in figure 1, had untapered wings of M and W plan forms, aspect ratio 4, and NACA 65-006 airfoil sections (parallel to the plane of symmetry) mounted on a pointed cylindrical body with four thin stabilizing fins. The break in the wing plan forms was at 50 percent of the exposed semi-span. The second type of configuration, shown in figure 2, had wings of M and fully sweptback plan forms, aspect ratio 6, taper ratio 0.6, and NACA 65A009 airfoil sections mounted on a body of curved profile with two thin vertical stabilizing fins. The coordinates for the body and nacelles are given in table I. For the second type of configuration, the M-wing had nacelles mounted at the spanwise location of the break in the wing plan form and the sweptback wing was tested with and without an identical nacelle at the same spanwise location. The break in the plan form of the M-wing was at 34 percent of the exposed semispan. In addition, a wingless configuration was flown which had four stabilizing fins.

### TESTS

Two models of each of the nontapered winged configurations of aspect ratio 4 were successfully test flown and one model of each of the tapered winged configurations of aspect ratio 6 were successfully flown, except

for the wingless configuration for which two models were flown. The models were launched at an elevation angle of  $70^\circ$  and propelled to supersonic speeds by means of a two-stage rocket propulsion system. The data were obtained during the coasting flight (decreasing speed) after burnout of the second stage rocket motor. A description of the test technique is given in reference 1.

Flexure tests were performed on the test airfoils and the results are presented in the appendix of this paper together with additional tests on wings of similar plan forms but of higher aspect ratio.

The probable inaccuracy in the values of wing drag coefficient are approximately  $\pm 0.002$  except at the extreme ends of the Mach number range. The Mach number is believed to be accurate to within  $\pm 0.01$ .

## RESULTS

The Reynolds number range of the tests is given in figure 3. Figure 4 shows the results for the test configurations as total drag coefficient  $C_{DT}$  (based on wing exposed area) against Mach number  $M$ . Figure 4(a) refers to the configurations with nontapered test wings of aspect ratio 4 and includes also the wingless body drag coefficients which have been taken from reference 1. Figure 4(b) refers to the configurations with tapered test wings of aspect ratio 6. The wingless curve in figure 4(b) represents the drag coefficient of the body with two stabilizing fins and has been obtained from the flight data for the four-finned wingless configuration by subtracting the measured drag of two fins. The data for the sweptback wing without nacelles are included to show the magnitude of the nacelle drag.

The difference in total drag coefficient between the winged and wingless configurations is referred to as wing drag coefficient  $C_{DW}$  and represents the isolated wing-plus-interference drag. Figure 5 presents wing drag coefficient against Mach number for the test wings. Included in figure 5(a) are the results of free-fall tests for a sweptback wing (reference 2) and a rectangular wing (reference 3) mounted on pointed cylindrical bodies. The reference sweptback wing had no taper, an aspect ratio of 5.4,  $45^\circ$  sweepback, and NACA 65-series sections 6.36 percent thick. The rectangular wing had no taper, an aspect ratio of 7.6, and NACA 65-series sections 6.00 percent thick. Although the reference wings are not exactly comparable to the test M- and W-wings, it is believed that differences are small enough to justify a rough comparison between the plan forms. Figure 5(b) shows the wing drag coefficients for the M-wing and swept wing with nacelles and for the swept wing without nacelles.

The same general results are noticed for the wings of aspect ratio 4 (fig. 5(a)) as for the wing of aspect ratio 6 (fig. 5(b)). Plan-form variations appeared to have greatest effect on zero-lift drag at transonic speeds where the M- and W-wings had greater drag than the sweptback plan form but less drag than the rectangular plan form. With increasing Mach number the drag differences between the wings of M, W, and sweptback plan forms became less until at  $M = 1.25$  the differences were very small. At transonic speeds the drag of the M-wing was considerably greater than the drag of the W-wing.

#### CONCLUSIONS

The zero-lift drag of wings having "M" and "W" plan forms has been measured in rocket model flight tests at Mach numbers from 0.8 to 1.4. The results were compared with a rectangular and a fully sweptback wing and the following conclusions were noted:

1. At transonic speeds both M- and W-wings had greater drag than a sweptback wing and less drag than a roughly comparable rectangular wing.
2. At transonic speeds the drag of the M-wing was considerably greater than the drag of the W-wing.
3. The differences between the M-wing, the W-wing, and the sweptback wing were much smaller at Mach numbers above 1.25.

Langley Aeronautical Laboratory  
National Advisory Committee for Aeronautics  
Langley Air Force Base, Va.

CONFIDENTIAL  
APPENDIX

## RESULTS OF FLEXURE TESTS

Little factual data are available with which one may judge the relative rigidity of M or W and fully swept wings. Therefore, simple flexure tests were made on both the flight-test wings of aspect ratio 4 and on a series of M and fully swept wings having rectangular sections. These data provide a very rough direct comparison of the relative deflection under load of the two types of plan forms.

In the flexure tests of the test wings of aspect ratio 4, measurements were made of the rotation and translation of the airfoil sections due to a concentrated load applied at the 35 percent tip chord location and due to a pure couple applied at the tip parallel to the plane of symmetry. The methods of loading these wings, that is, a couple and a concentrated load at the tip on the 35-percent-chord line, are but simple and arbitrary loadings and should not be misconstrued to be simulated air loads. The results are shown in figure 6 plotted against spanwise distance from the model center line  $\frac{y}{b/2}$ . The upper two plots give the vertical deflection of the 35-percent-chord line due to the couple and load and the lower plots show the section twist (measured parallel to the plane of symmetry) due to the load and couple. Positive values of loads and deflections correspond to bending the wing up and positive values of couples and twists correspond to rotating the sections such that the leading edge moves down.

In general, for the present loading conditions, the M- and W-wings indicated less twist and deflection for equal loads than did the fully swept wing.

The supplementary tests were made on wings of higher aspect ratios (8, 10, and 12) having 12-percent-thick rectangular sections. The load was applied at the 50 percent tip chord location and the pure couple applied at the tip parallel to the plane of symmetry. The results are shown in figure 7 and are presented in the same form as in figure 6. The indications are that the deformation of the M- and W-wings was, in general, less than that of the sweptback wing.

CONFIDENTIAL

## REFERENCES

1. Morrow, John D., and Katz, Ellis: Flight Investigation at Mach Numbers from 0.6 to 1.7 to Determine Drag and Base Pressures on a Blunt-Trailing-Edge Airfoil and Drag of Diamond and Circular-Arc Airfoils at Zero Lift. NACA RM L50E19a, 1950.
2. Mathews, Charles W., and Thompson, Jim Rogers: Drag Measurements at Transonic Speeds of NACA 65-009 Airfoils Mounted on a Freely Falling Body to Determine the Effects of Sweepback and Aspect Ratio. NACA RM L6K08c, 1947.
3. Thompson, Jim Rogers, and Marschner, Bernard W.: Comparative Drag Measurements at Transonic Speeds of an NACA 65-006 Airfoil and a Symmetrical Circular-Arc Airfoil. NACA RM L6J30, 1947.



TABLE I.- COORDINATES FOR BODY AND NACELLES

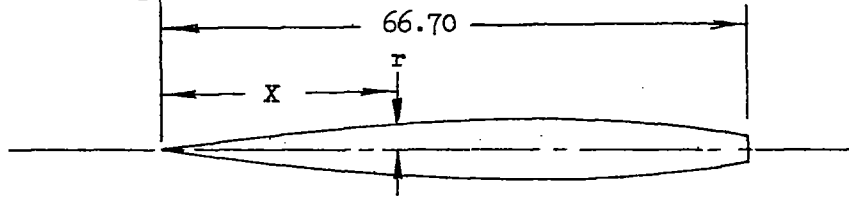

Body Coordinates (in.)			
X	r	X	r
0	0.0000	32.0	3.2504
.4	.1848	36.0	3.3144
.6	.2384	40.0	3.3336
1.0	.3424	44.0	3.3040
2.0	.5776	48.0	3.2192
4.0	.9640	52.0	3.0298
6.0	1.2904	56.0	2.8404
8.0	1.5768	60.0	2.6511
12.0	2.0744	64.0	2.4617
16.0	2.4720	66.70	2.3340
20.0	2.7720		
24.0	2.9928		
28.0	3.1464		
Nose radius = 0.040			

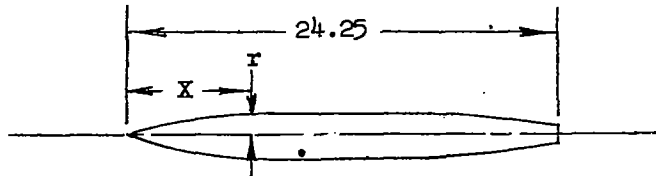

Nacelle Coordinates (in.)			
X	r	X	r
0	0	8.605	1.255
.100	.070	16.830	1.255
.300	.169	17.872	1.237
.830	.336	18.913	1.195
1.230	.489	19.955	1.127
1.830	.622	20.996	1.029
2.330	.744	22.038	.909
2.580	.800	23.079	.768
2.958	.876	24.121	.616
3.585	.974	24.250	.598
4.840	1.105		
6.095	1.190		
7.350	1.240		



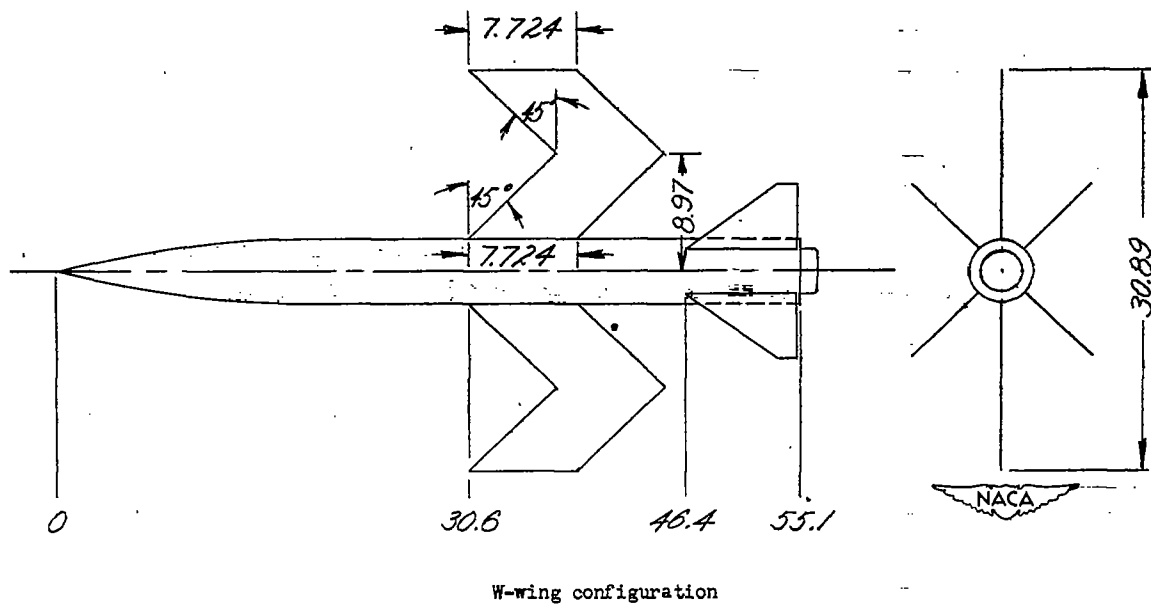
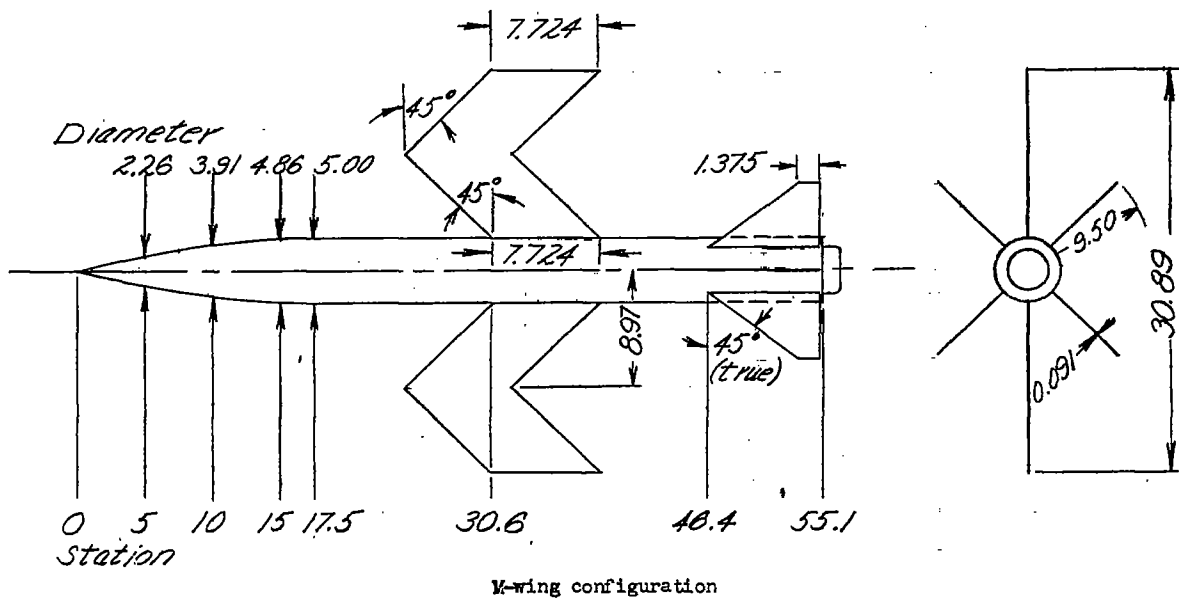

(a) General arrangement. All dimensions shown in inches.

Figure 1.- Test configurations with wings of aspect ratio 4 and NACA 65-006 airfoil sections. Wing area (included), 1.657 square feet; wing area (exposed), 1.389 square feet; body frontal area, 0.137 square feet; and fin area (exposed), 0.948 square feet.

NACA RM L50G31

CONFIDENTIAL

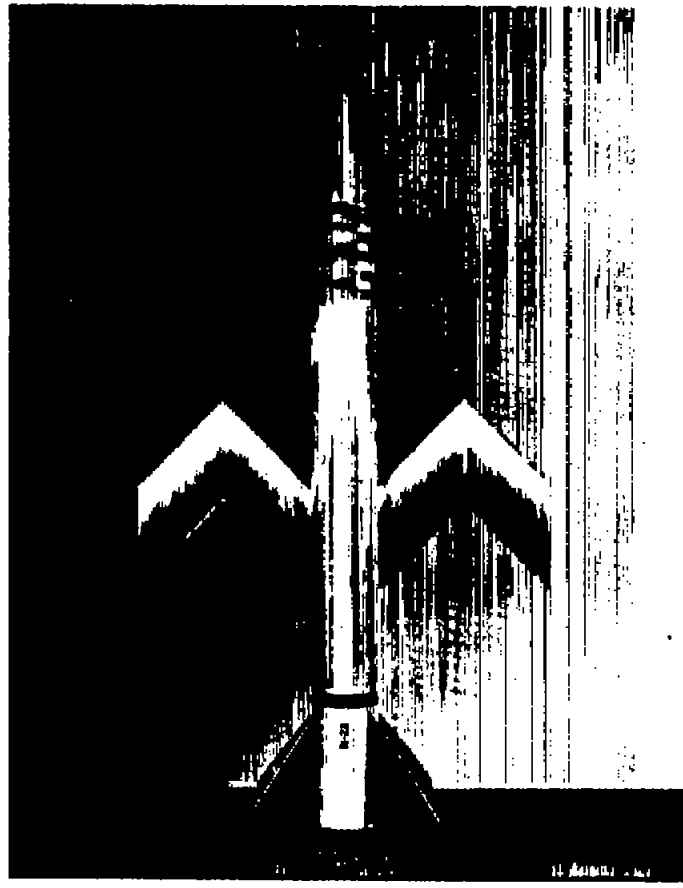

M-wing configuration

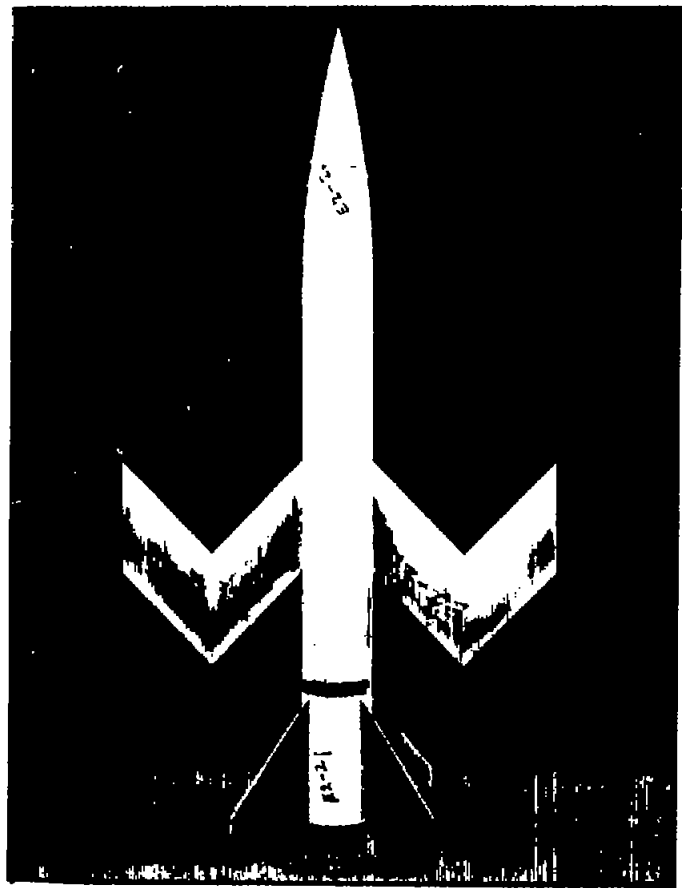

W-wing configuration

(b) General view.

Figure 1.- Concluded.

NACA  
L-61806

NACA  
L-62254

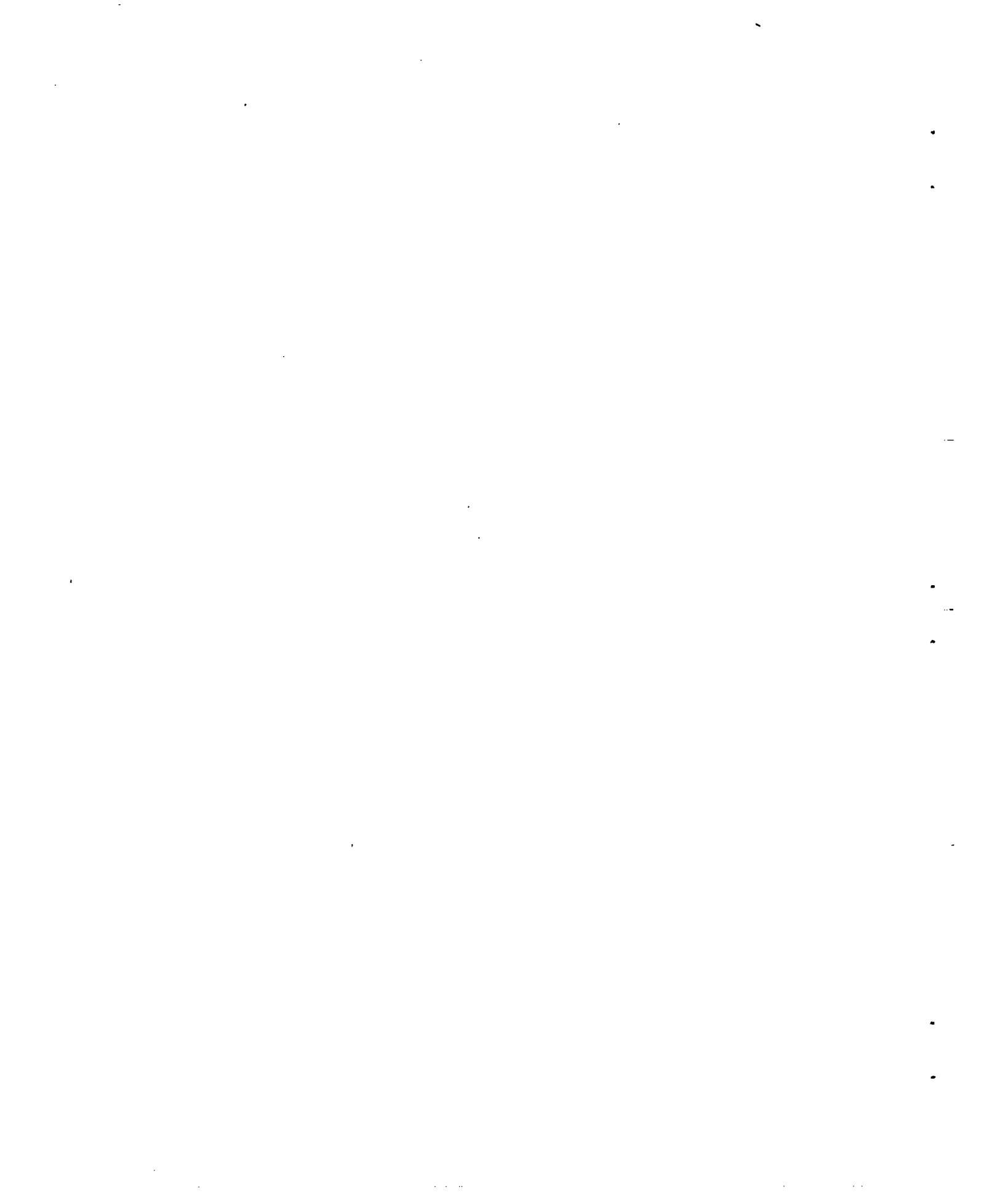

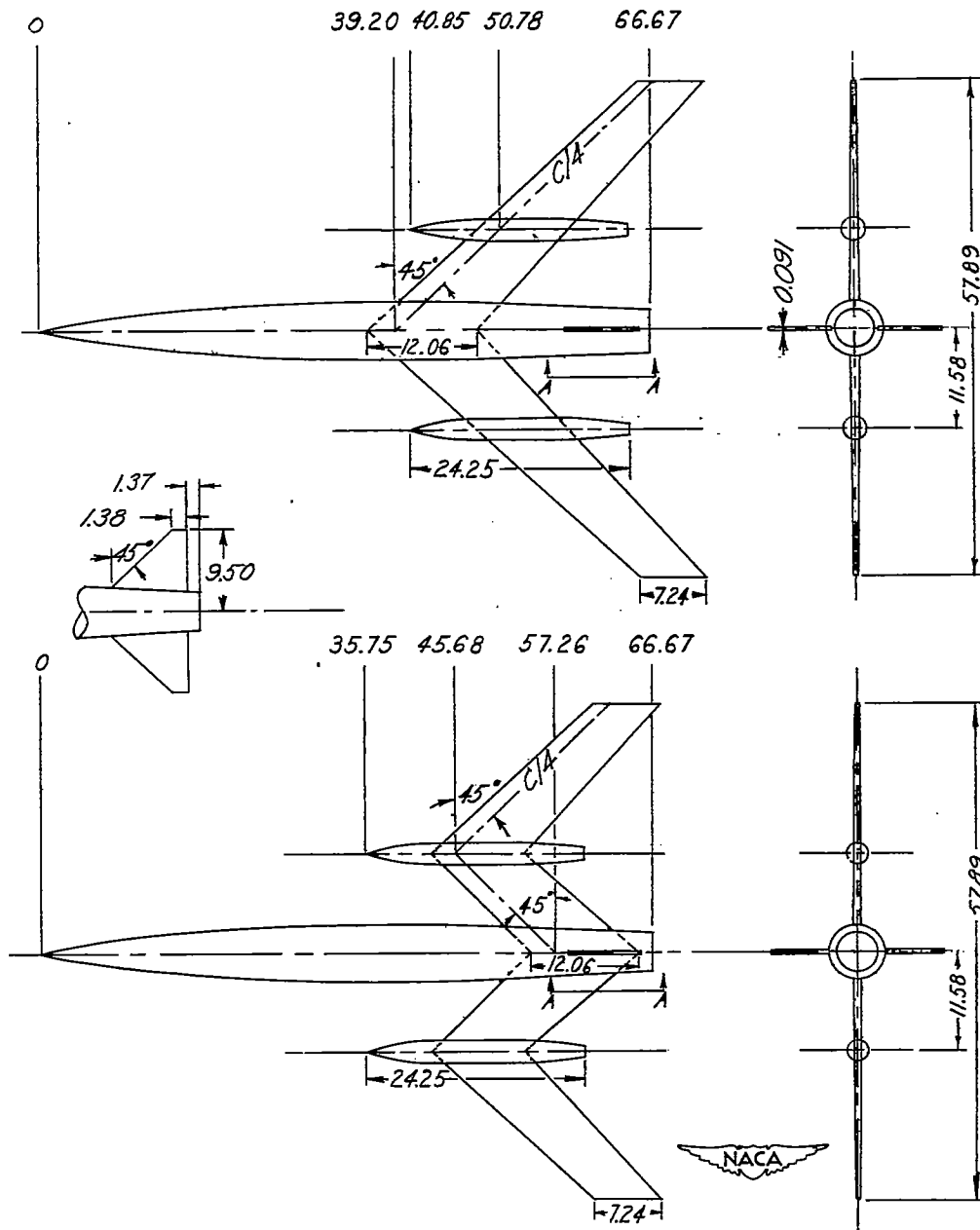

(a) General arrangement. All dimensions shown in inches.

Figure 2.- Test configurations with wings of aspect ratio 6 and NACA 65A009 airfoil sections. Sweptback winged configuration was also tested without nacelles. Wingless configuration was tested with four stabilizing fins. Wing area (included), 3.878 square feet; wing area (exposed), 3.333 square feet; body frontal area, 0.242 square feet; fin area (exposed), 0.468 square feet; and nacelle frontal area, 0.068 square feet.

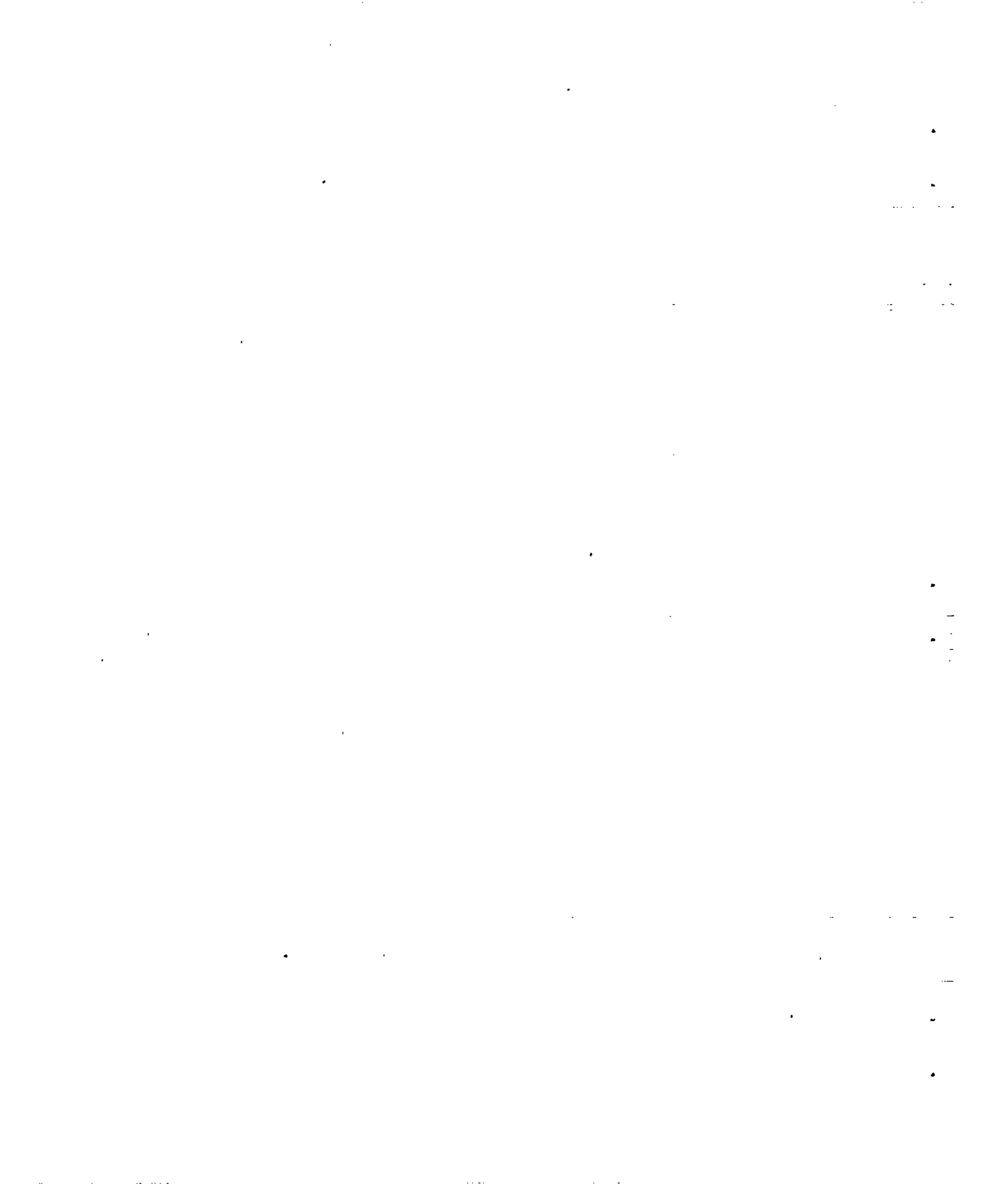

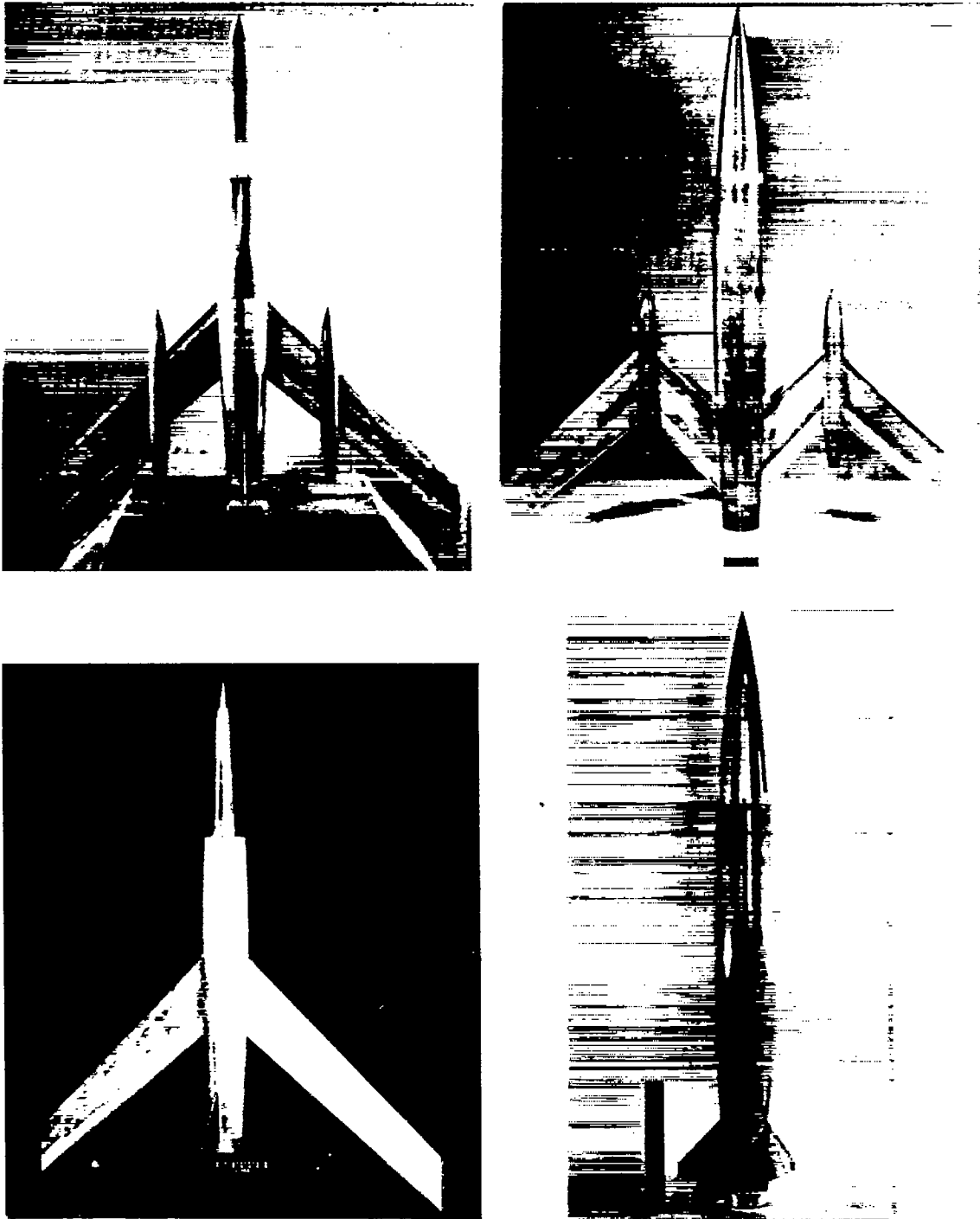

(b) General view.

Figure 2.- Concluded.

NACA  
L-64929

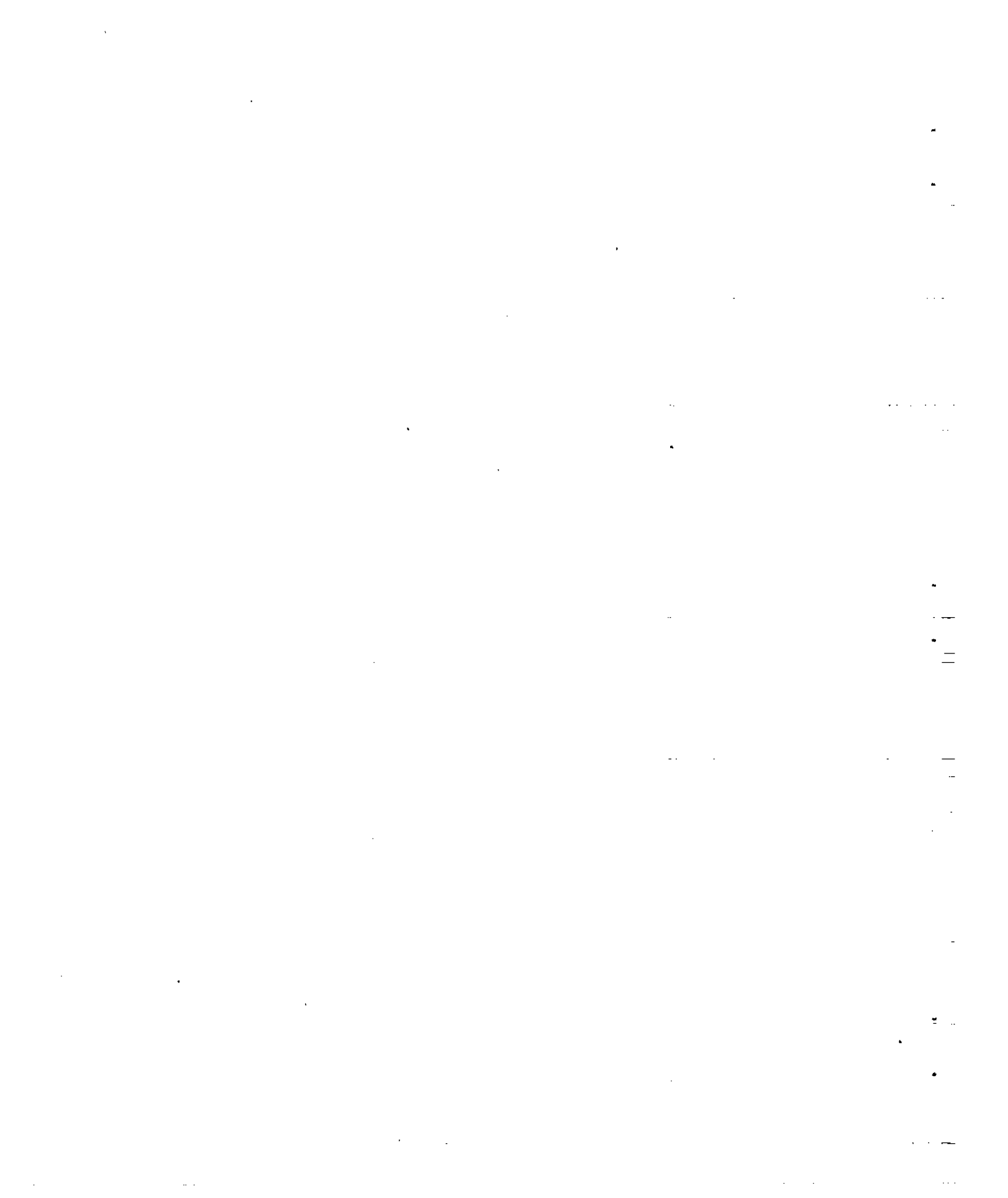



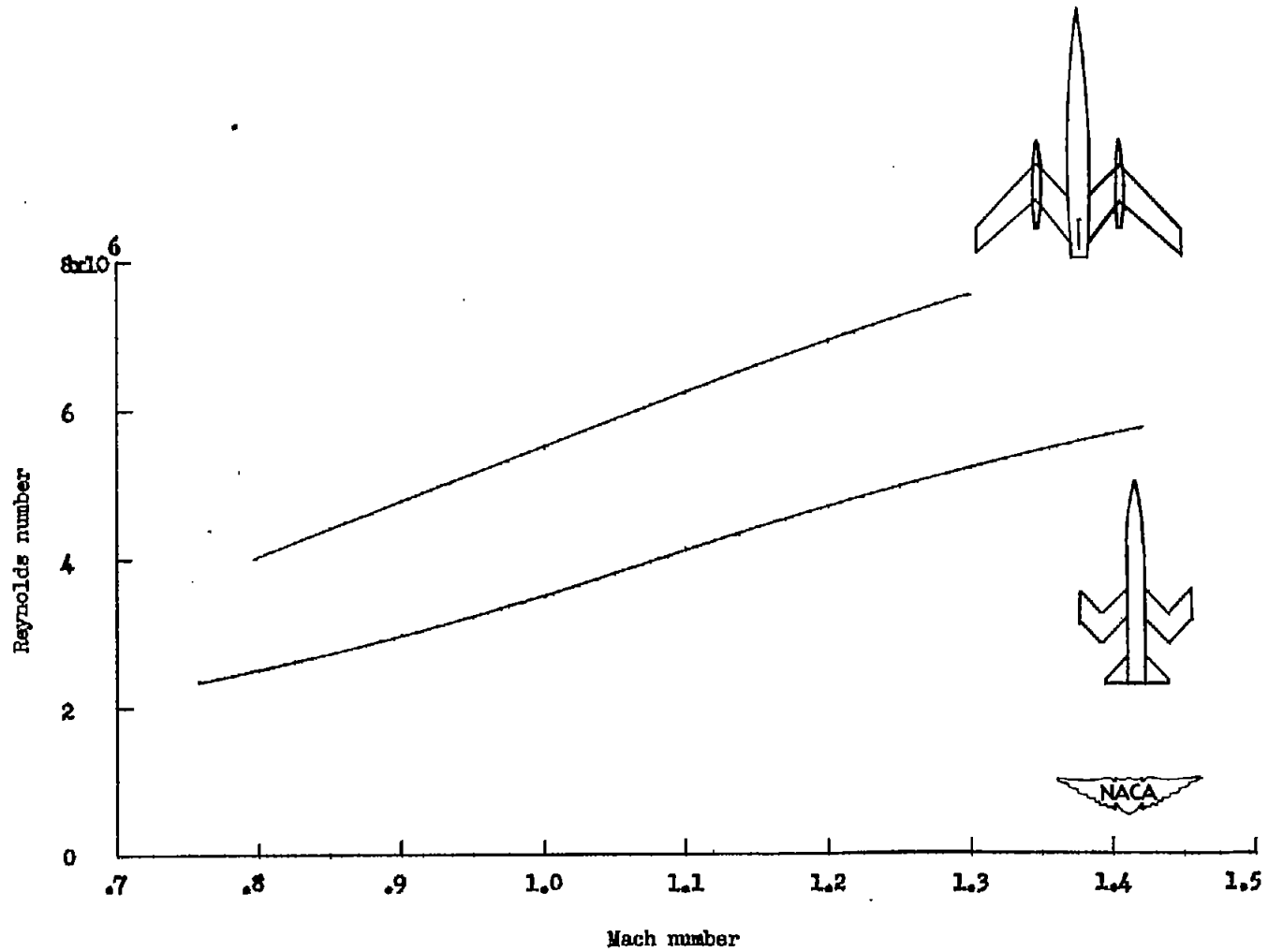
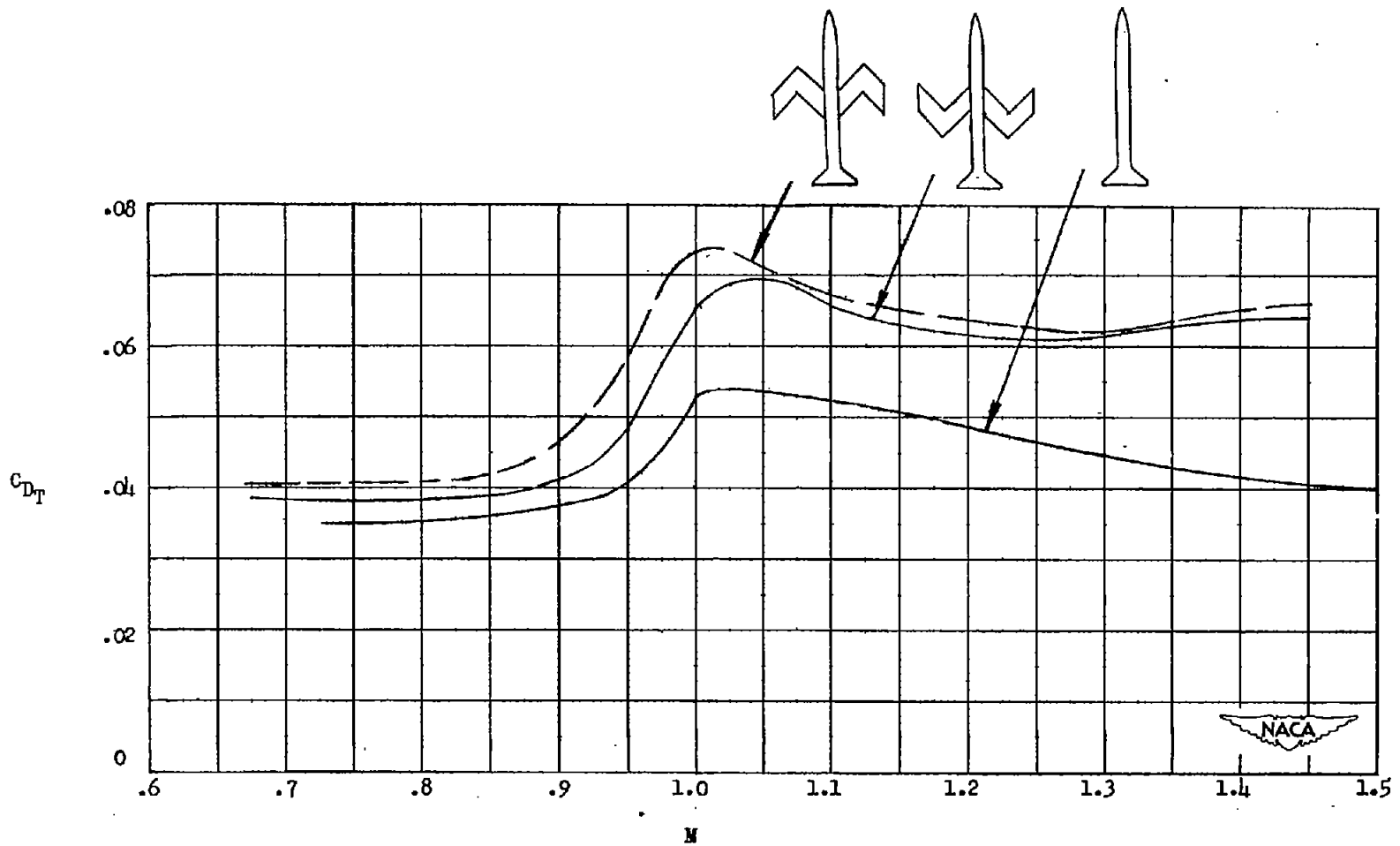
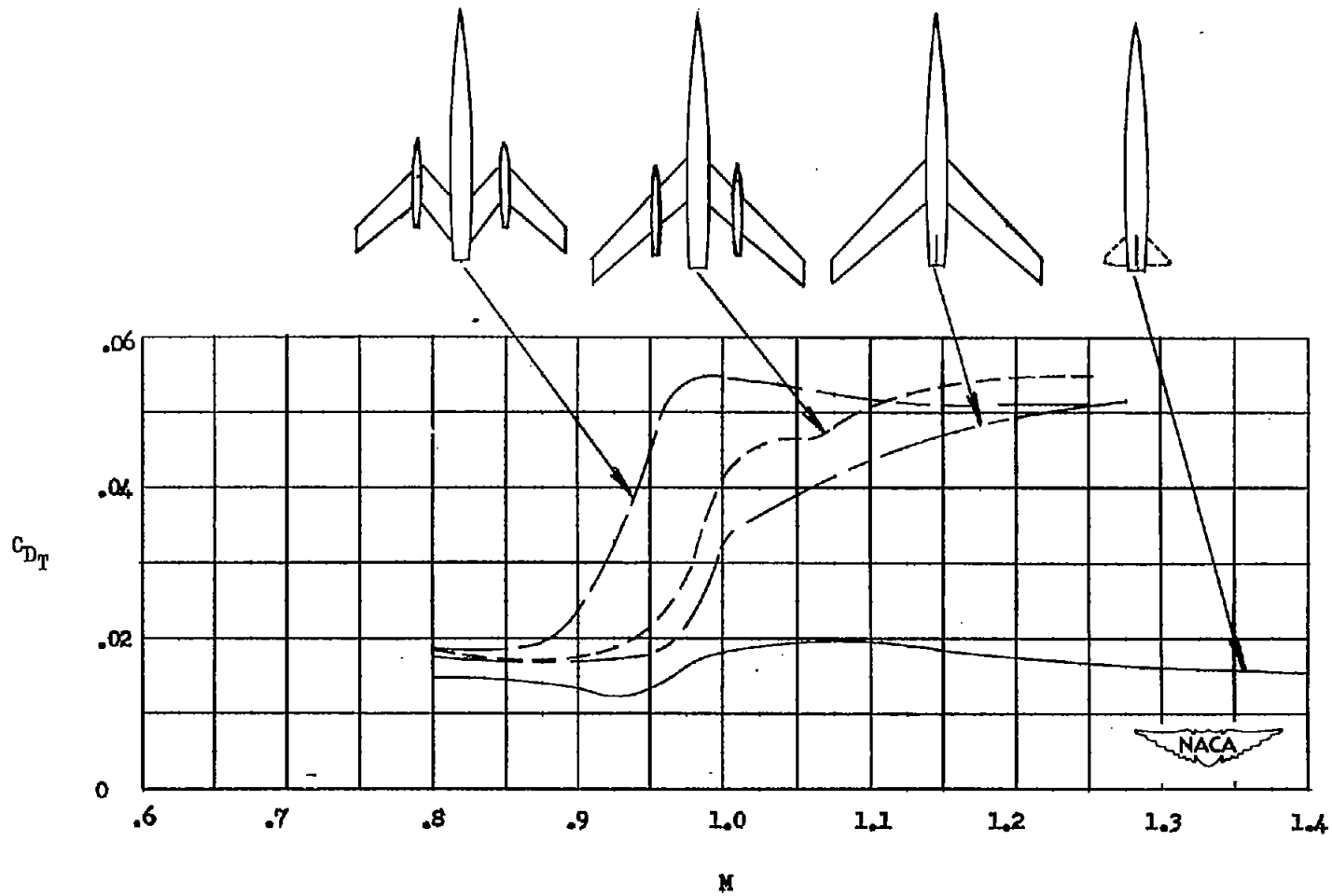

Figure 3.- Variation of Reynolds number for typical test models representing two types of test configurations. Reynolds number based on wing mean aerodynamic chord.



(a) Wings of aspect ratio 4 and NACA 65-006 airfoil sections.

Figure 4.- Total drag coefficient against Mach number. Drag coefficients for a reference wingless configuration are included for comparison.



(b) Wings of aspect ratio 6 and NACA 65A009 airfoil sections.

Figure 4.- Concluded.

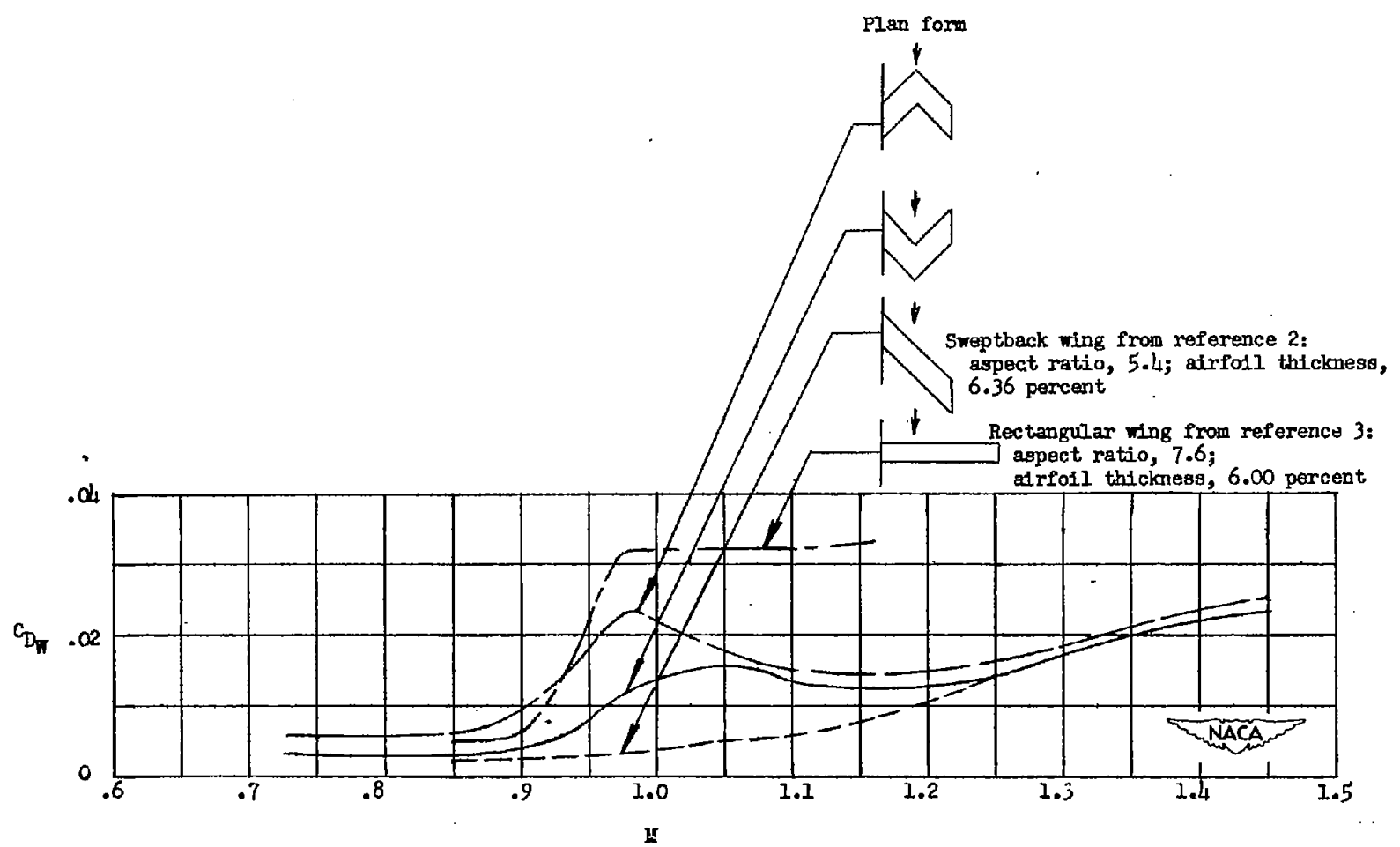

(a) Wings of aspect ratio 4 with NACA 65-006 airfoil sections. Also shown are drag coefficients for reference rectangular and sweptback wings with NACA 65-series airfoil sections.

Figure 5.- Wing drag coefficient against Mach number.

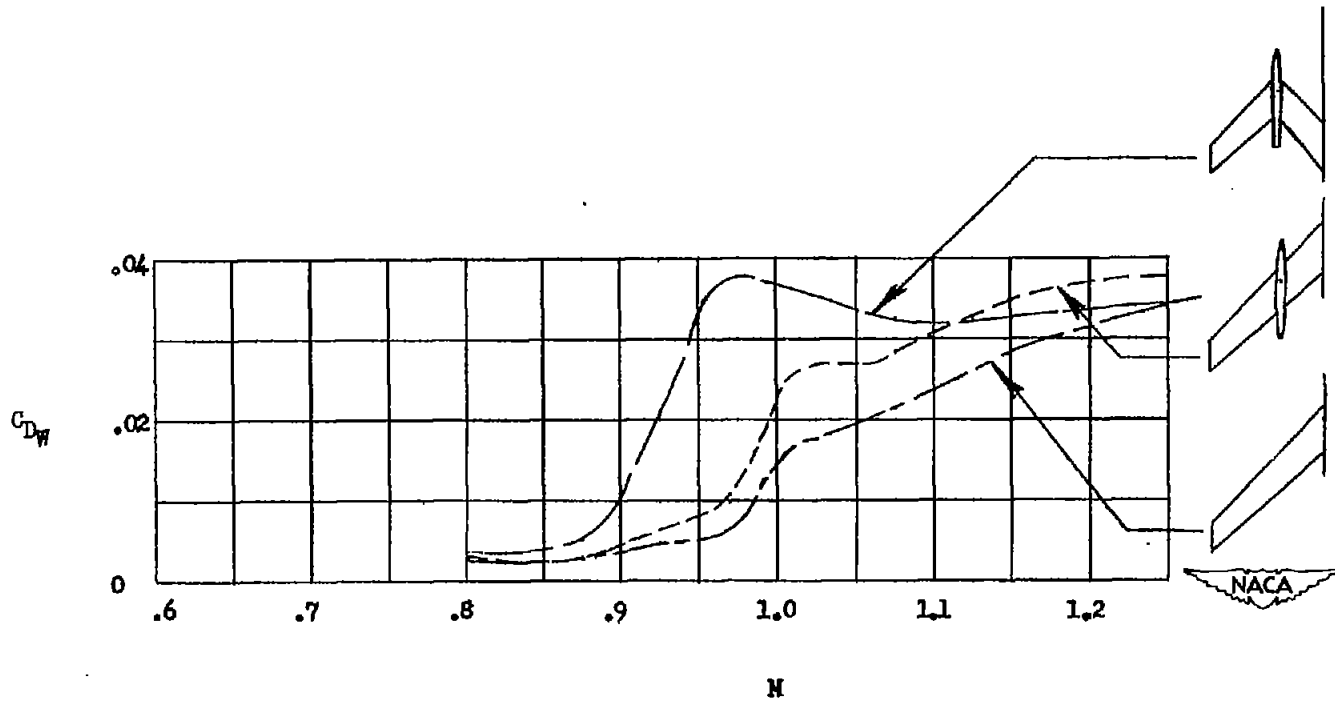

(b) Wings of aspect ratio 6 with NACA 65A009 airfoil sections.

Figure 5.- Concluded.

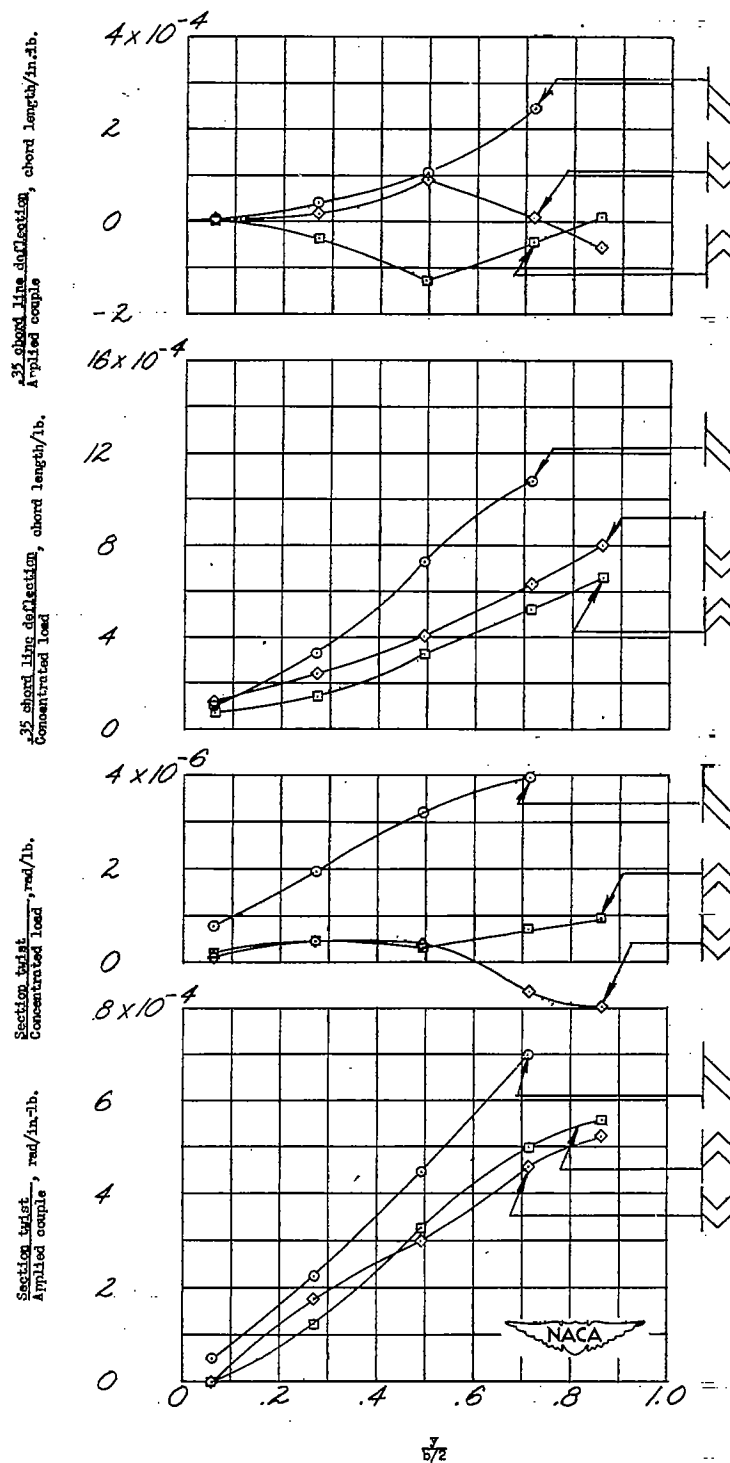
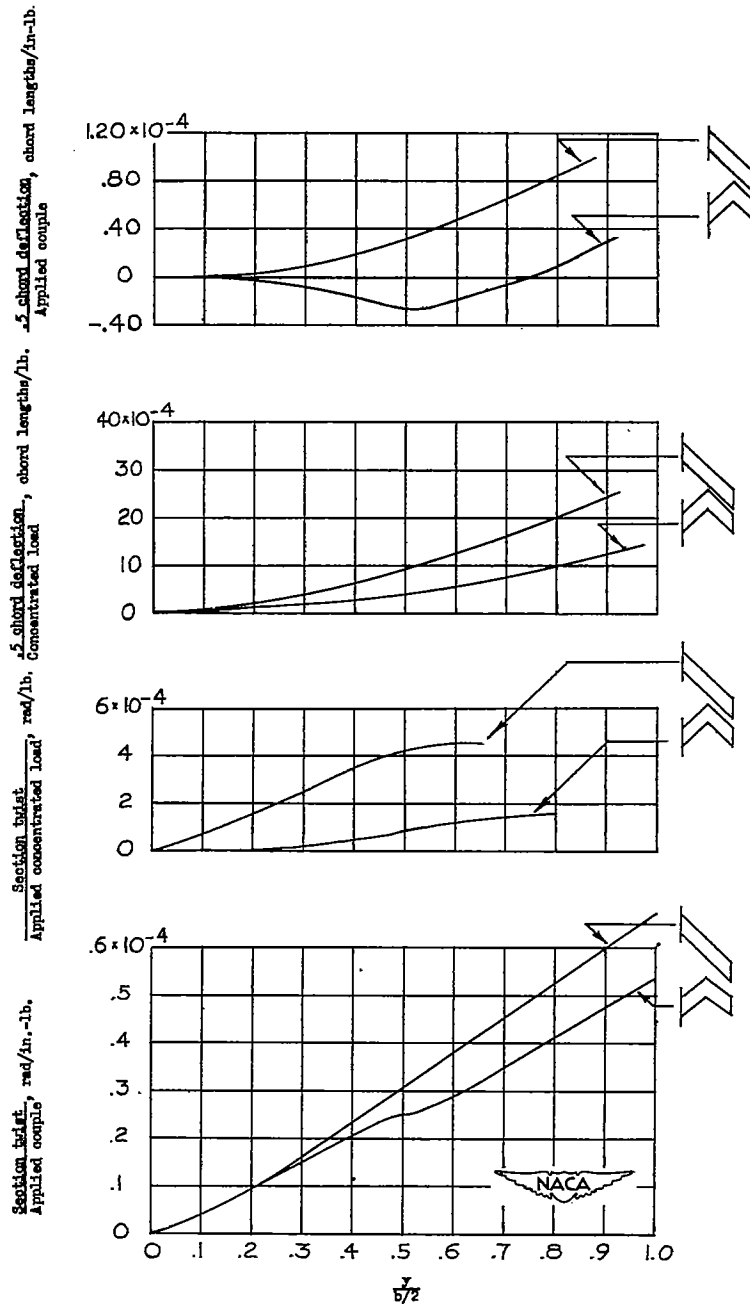
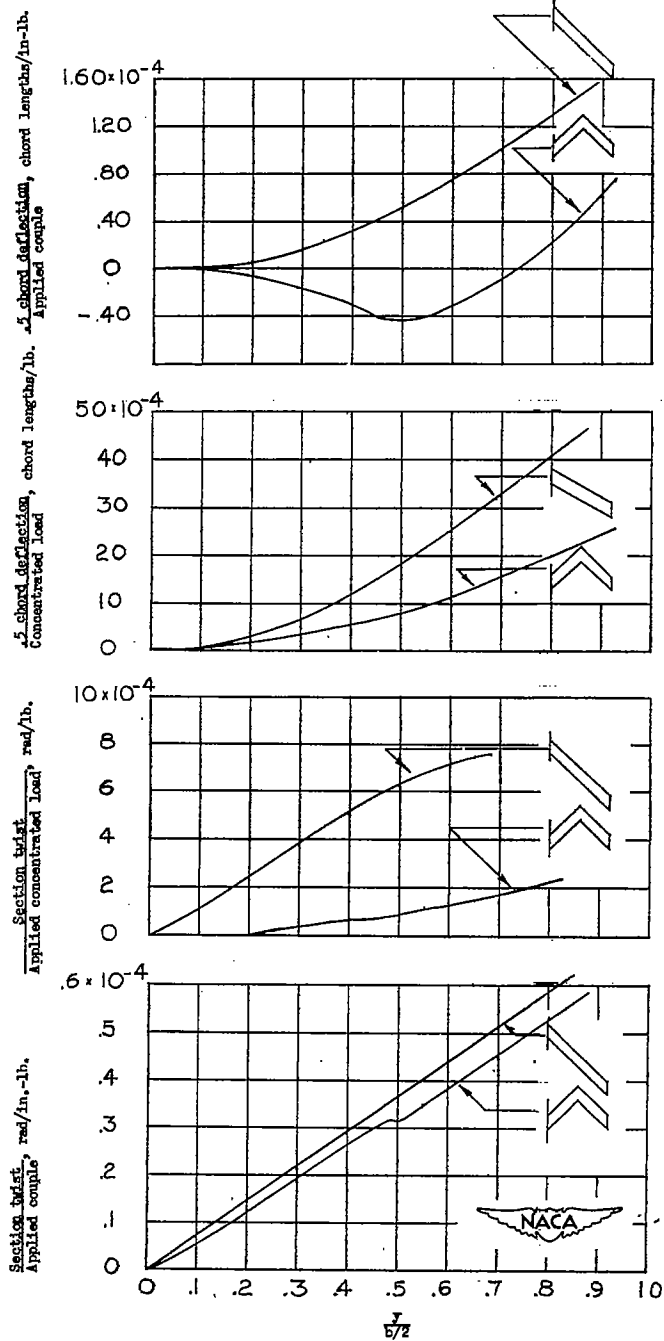

Figure 6.- Bending and torsional rigidity of solid dural wings having M, W, and 45° sweptback plan forms with aspect ratio of 4. Sections are NACA 65-006 airfoils. Chord length, 0.644 foot.



(a) Aspect ratio 8.

Figure 7.- Bending and torsional rigidity of solid dural wings having M and 45° sweptback plan forms. Rectangular sections are 12 percent thick. Chord length, 0.348 foot.



(b) Aspect ratio 10.

Figure 7.- Continued.



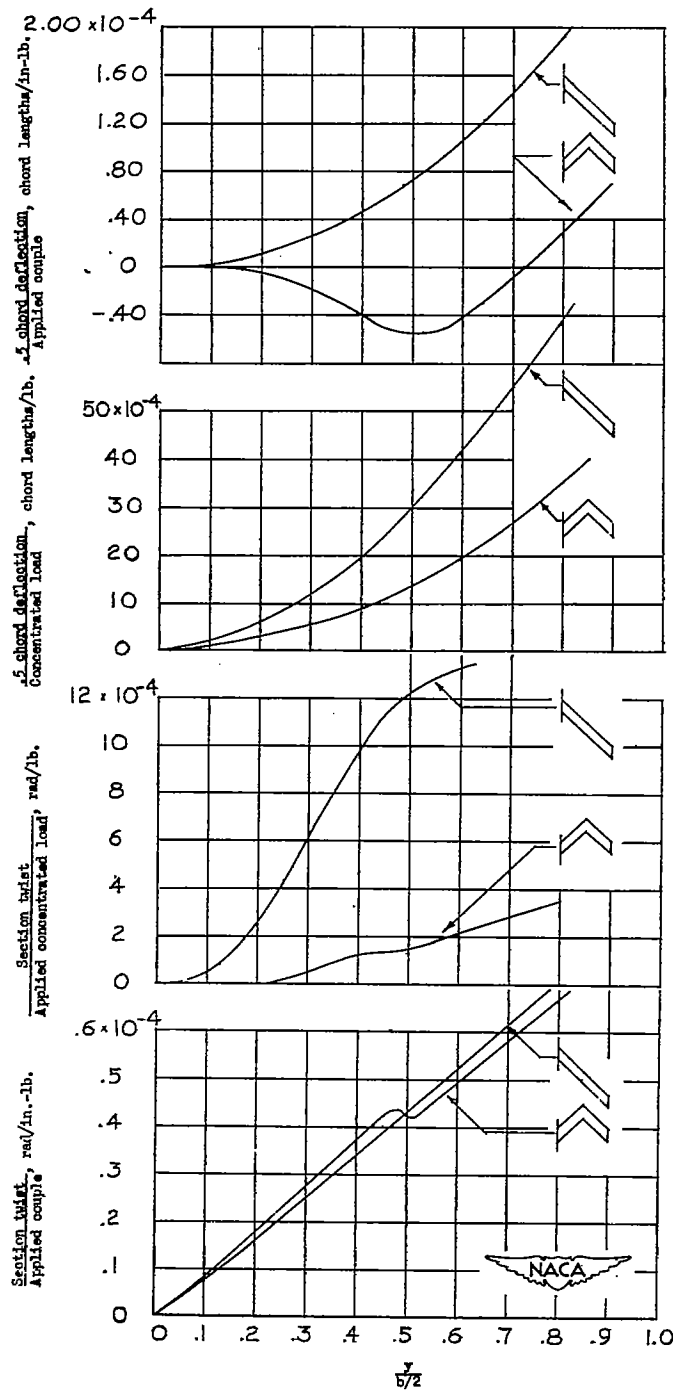

(c) Aspect ratio 12.

Figure 7.- Concluded.