

M. Hannah

NACA TN No. 1621

NATIONAL ADVISORY COMMITTEE FOR AERONAUTICS

TECHNICAL NOTE

NO. 1621

TWO-DIMENSIONAL UNSTEADY LIFT PROBLEMS

IN SUPERSONIC FLIGHT

By Max. A. Heaslet and Harvard Lomax

Ames Aeronautical Laboratory,
Moffett Field, Calif.



WASHINGTON

JUNE 1948



3 1176 01433 9403

NATIONAL ADVISORY COMMITTEE FOR AERONAUTICS

TECHNICAL NOTE NO. 1621

TWO-DIMENSIONAL UNSTEADY LIFT PROBLEMS

IN SUPERSONIC FLIGHT

By Max. A. Heaslet and Harvard Lomax

SUMMARY

The variation of pressure distribution is calculated for a two-dimensional supersonic airfoil either experiencing a sudden angle-of-attack change or entering a sharp-edged gust. From these pressure distributions the indicial lift functions applicable to unsteady lift problems are determined for the two cases. A close similarity is shown to exist between the calculated functions for varying free-stream Mach number and the corresponding functions in three-dimensional incompressible flow for varying aspect ratio.

Results are presented which permit the determination of maximum increment in lift coefficient attained by an unrestrained airfoil during its flight through a gust. As an application of these results, the minimum altitude for safe flight through a specific gust is calculated for a particular supersonic wing of given strength and wing loading.

INTRODUCTION

The study of the unsteady lift of wings in an incompressible medium has been developed along two different lines. In reference 1, R. T. Jones introduced the concept of indicial lift functions for wings of finite aspect ratio and, using as a basis the work of Wagner (reference 2) on the two-dimensional potential theory of airfoils in nonuniform motion, has shown how the calculation of lift under various conditions of motion can be effected. In reference 3, Theodorsen considered nonsteady motion in its relation to the general theory of aerodynamic instability and the determination of the aerodynamic forces on harmonically oscillating airfoils. This latter approach has been extended to include high-speed problems and in two recent papers Garrick and Rubinow (references 4 and 5) have given results on flutter and oscillating air-force calculations for wings in supersonic flow.

The present report employs the method of attack introduced by Jones and considers the case of a two-dimensional airfoil moving supersonically in an arbitrary manner, provided the assumptions of small perturbation theory are satisfied. The principal contribution lies in the determination of indicial pressure distributions which are readily calculated in supersonic motion and from which indicial lift, drag, and pitching moments may be computed. From these results the indicial lift functions are calculated explicitly. The methods used to find the pressure distributions also afford considerable insight into the same problem for airfoils at subsonic speeds.

As an application of the analysis, the results are applied to the special case of an unrestrained airfoil entering a sharp-edged gust. The resultant forces are found to be comparable in magnitude, for Mach numbers in the neighborhood of 1.3, to those given in reference 1 for subsonic incompressible flow.

SYMBOLS

a	speed of sound
c	chord length
c_l	section lift coefficient
$c_{l\alpha}$	indicial lift coefficient for angle-of-attack change
c_{lg}	indicial lift coefficient for wing entering gust
g	acceleration of gravity
M	free-stream Mach number
m	mass
Δp	difference in pressures between lower and upper surfaces of airfoil
q	$(\frac{1}{2}\rho_0 V_0^2)$
s	distance measured in half-chord lengths
S	area of wing
p	perturbation static pressure

t', τ'	time in seconds
t	transformed time variable (See equations (7).)
T	t/c
u	perturbation velocity component in x direction
V_0	free-stream velocity
w	perturbation velocity component in z direction
w_0	z component of velocity of gust
W	weight of wing
x, z	Cartesian coordinates
α	angle of attack
μ	$2m/\rho MSc$
ρ	perturbation density
ρ_0	free-stream density
σ	area over which surface integral is evaluated
Φ	perturbation velocity potential

Subscripts

o	free-stream conditions
1	variable of integration
u	upper surface
l	lower surface

ANALYSIS

Derivation of Basic Differential Equation

The pressure distribution over an airfoil in a compressible medium is obtainable from the solution of a boundary value problem associated with a particular second-order partial differential equation. The derivation of the linearized form of this equation, obtained under the assumptions of small perturbation theory, proceeds as follows:

Let u, w be perturbation velocity components parallel, respectively, to the Cartesian axes x', z' and denote by p perturbation pressure, by ρ perturbation density, and by a the velocity of sound. Then if t' denotes time, V_0 is the constant free-stream velocity, and ρ_0 is the constant free-stream density, the linearized Eulerian equations are

$$\frac{\partial u}{\partial t'} + V_0 \frac{\partial u}{\partial x'} = - \frac{1}{\rho_0} \frac{\partial p}{\partial x'} \quad (1)$$

$$\frac{\partial w}{\partial t'} + V_0 \frac{\partial w}{\partial x'} = - \frac{1}{\rho_0} \frac{\partial p}{\partial z'}$$

The linearized equations of continuity and state are, respectively,

$$\frac{\partial \rho}{\partial t'} + V_0 \frac{\partial \rho}{\partial x'} + \rho_0 \left(\frac{\partial u}{\partial x'} + \frac{\partial w}{\partial z'} \right) = 0 \quad (2)$$

$$\rho = \frac{1}{a_0^2} p \quad (3)$$

After the introduction of the perturbation velocity potential ϕ integration of equations (1) yields

$$\frac{\partial \phi}{\partial t'} + V_0 \frac{\partial \phi}{\partial x'} = - \frac{1}{\rho_0} p + \text{const.} \quad (4)$$

while equations (2) and (3) give the expression

$$\left(\frac{\partial}{\partial t'} + V_0 \frac{\partial}{\partial x'} \right) \frac{p}{\rho_0 a_0^2} = - \left(\frac{\partial^2}{\partial x'^2} + \frac{\partial^2}{\partial z'^2} \right) \phi \quad (5)$$

The combination of equations (4) and (5) leads to the desired partial differential equation

$$(1-M^2) \frac{\partial^2 \phi}{\partial x'^2} + \frac{\partial^2 \phi}{\partial z'^2} - \frac{2M}{a_0} \frac{\partial^2 \phi}{\partial x' \partial t'} - \frac{1}{a_0^2} \frac{\partial^2 \phi}{\partial t'^2} = 0 \quad (6)$$

where M is the free-stream Mach number.

Equation (6) can be reduced to the normalized form of the two-dimensional wave equation of mathematical physics by means of the transformation

$$\left. \begin{aligned} x &= x' - Ma_0 t' \\ z &= z' \\ t &= a_0 t' \end{aligned} \right\} \quad (7)$$

In these variables the equation is written

$$\frac{\partial^2 \phi}{\partial t^2} - \frac{\partial^2 \phi}{\partial x^2} - \frac{\partial^2 \phi}{\partial z^2} = 0 \quad (8)$$

In accordance with the assumptions underlying the derivation of equation (8), its application to problems in airfoil theory is, of course, limited to cases where the induced velocities are small compared to the free-stream velocity and the effects of viscosity do not alter the results of the potential flow solution.

The rectangular coordinate system associated with equation (6) is fixed in the wing which is, in turn, immersed in a free stream of velocity V_0 directed along the positive x -axis. The transformation introduced in equation (7) fixes the x, z coordinate system in space so that the airfoil moves in the negative x direction and the free-stream velocity is zero. A distortion of the time axes is also involved so that the differential equation appears in canonical form. Equations (6) and (8) are, of course, well known in the theory of unsteady motion and in the study of sound waves. It is natural that these two fields of study should yield the same fundamental equations since, in small perturbation theory, the wing may be thought of as a distribution of acoustic radiators.

Solution For Given Boundary Conditions

The boundary conditions which are to be satisfied have the same property as those encountered in steady-state thin-airfoil theory; that is, the prescribed data are given in the $z = 0$ plane. The particular problems with which this report deals are those of finding pressure distributions over a flat plate. Thus, w will be specified over a portion of the $z = 0$ plane and, elsewhere throughout the plane, loading must be zero.

Two boundary-value problems are to be considered: first, the case of an airfoil either starting from rest at a given angle of attack α or experiencing along the entire chord a change α in stream direction without a pitching motion, and second, the case of a constrained wing entering a sharp-edged gust with a vertical velocity w_0 . In the former case the motion is that of an airfoil suddenly sinking without rotation. These boundary conditions are more readily pictured with the aid of figure 1. Figure 1(a) shows the conditions which must be satisfied in order to solve the angle-of-attack problem. The trace of the leading edge of the wing traverses the line $x = -Mt$, while the trailing edge lies on $x = c - Mt$ where c is chord length. The region bounded by these lines and the line $t = 0$ is the region occupied by the airfoil as time passes. Since the axes are fixed and the airfoil moves in the negative x direction, the velocity at which the airfoil travels determines the inclination of the loci of the leading- and trailing-edge traces. Over the "area" occupied by the airfoil in the x, t plane, w must equal $-V_0\alpha$ and elsewhere no jump in pressure can occur. The gust problem (fig. 1(b)) does not differ essentially from the previous problem except that here the region over which the modification of w is effective is not entirely the region occupied by the airfoil but rather the region occupied simultaneously by the airfoil and the gust. Fixing, for convenience, the edge of the gust along the t -axis, this axis will form the right-hand boundary of the region over which $w = -w_0$.

Since the partial differential equation is linear and the solutions are therefore additive, these boundary conditions clearly should fit the following physical event: a wing of trapezoidal plan form, indicated in figure 2, flies at a steady lift and angle of attack prior to $t = 0$; at $t = 0$ the wing either experiences a change in angle of attack α with no pitching motion or enters a sharp-edged gust of constant vertical velocity w_0 , the gust extending from its edge to all negative values of x . The wing in each case is then restrained so that, relative to the original wind vector, the wing remains at an angle of attack α or, in the gust case, continues fixed at the same angle of attack.

The solution to similar boundary-value problems has been discussed at length in reference 6. In that report the development was adapted to the case where equation (8) represented the steady-state equation for wing problems in three dimensions and the characteristic cones of the equation had the immediate physical interpretation of Mach cones or infinitesimal shock disturbances. Green's theorem was applied to solve the boundary-value problems involved and it was shown that the solution obtained could be interpreted as a surface distribution of sources and doublets. Finally, the difficulties arising in the discussion of the singularities on the characteristic cones and the integration of the supersonic doublet were overcome through the introduction of an integration technique which involved using the "finite part" of the given integrals.

The methods and conclusions obtained in reference 6 can be adapted immediately to the problems discussed herein for the mathematical reasoning remains almost identical. The physical interpretations of the two cases must, of course, be modified. Thus, the characteristic cones of the differential equations, traces of which are shown in figures 1 and 3, are no longer the well-known Mach cones; rather, they represent the distance to which a disturbance occurring at a point fixed by the apex of the cone will travel in the time t . Despite the fact that such physical interpretations are undeniably useful in understanding and applying the results, the solution of the basic differential equation for the boundary values involved is quite independent of these material dissimilarities. It follows that the methods developed and discussed in detail in reference 6 can be applied directly to the given problems with only minor changes in notation.

Referring to figure 1, it is evident that for supersonic flight the air ahead of the wing is unaffected by the approach of the wing and, further, that the induced velocities on the upper surface of the airfoil are independent of the shape of the lower surface. Consequently the pressure distribution will be found on the upper surface, as if the airfoil section were symmetrical, and then, for the flat plate, the pressure distribution on the lower surface will be equal in magnitude and opposite in sign. As in reference 6, the solution to such a problem can be obtained from a distribution of sources.

In the actual computation of the pressures over a section traveling at supersonic speeds, certain regions are conveniently defined. These regions depend on the relative slope of the traces of the leading and trailing edges and the trace of the characteristic cone in the x, t plane (fig. 3). The perturbation velocity potential is given by the formula

$$\phi = -\frac{w_u}{\pi} \iint_{\sigma} \frac{dx_1 dt_1}{\sqrt{(t-t_1)^2 - (x-x_1)^2 - z^2}} \quad (9)$$

where σ is the area in the x, t plane of the region occupied by the wing section and bounded by the trace of the forecone from the point x, z, t . If p_l and p_u denote, respectively, pressures on the upper and lower surface of the wing

$$\frac{\Delta p}{q} = \frac{p_l - p_u}{q} = \frac{4}{V_0^2} \left(\frac{\partial \phi}{\partial t'} + V_0 \frac{\partial \phi}{\partial x'} \right) = \frac{4}{V_0 M} \frac{\partial \phi}{\partial t} \quad (10)$$

Using equations (9) and (10), direct calculation shows that for a sudden angle-of-attack change, the following relations hold

Region A (between lines $x = -Mt$, $x = -t$, and $x = c - Mt$)

$$\frac{\Delta p}{q} = \frac{4\alpha}{\sqrt{M^2-1}} \quad (11a)$$

It follows that in this region the steady-state Ackeret-type load distribution has been attained.

Region B (between lines $x = -t$, $x = t$, and $x = c - Mt$)

$$\frac{\Delta p}{q} = \frac{4\alpha}{\sqrt{M^2-1}} \left[\frac{1}{\pi} \arccos \frac{Mx+t}{x+Mt} + \frac{\sqrt{M^2-1}}{\pi M} \left(\frac{\pi}{2} + \arcsin \frac{x}{t} \right) \right] \quad (11b)$$

Region C (between lines $x = t$, $t = 0$, and $x = c - Mt$)

$$\frac{\Delta p}{q} = \frac{4\alpha}{M} \quad (11c)$$

The result obtained for Region C is of particular interest since it holds for airfoils at subsonic as well as supersonic speeds. Moreover, the mechanics of the interaction between the airfoil and the fluid are such that other methods of derivation, furnishing added insight into the nature of the phenomenon, may be developed. Consider a flat plate of infinite aspect ratio flying at a velocity V_0 either greater than or less than the velocity of sound a_0 in the undisturbed air. The airfoil is assumed to undergo a change in its motion at the time $t = 0$ so that subsequent to this time it has increased its angle of attack by the amount α . It follows that the sudden increment in lift can be calculated from a knowledge of

the induced effects on the air produced by an added vertical velocity of the plate equal to $-V_0\alpha$. As a result of this vertical motion two plane Rayleigh waves will emanate from the plate, a compression wave from the lower surface and an expansion wave from the upper surface. The velocities of the wave fronts are equal to a_0 while the induced velocities in the waves are equal in magnitude to $V_0\alpha$.

The lift on the wing can be determined in two ways: from impulse relations and from energy considerations. In the former case, assume that the forces per unit span on the upper and lower surfaces are f_u and f_l , respectively. After an elapse of time Δt the wave fronts have advanced a distance $a_0\Delta t$ and each includes a mass of air equal to $\rho_0 c a_0 \Delta t$ per unit span. From Newton's second law of motion

$$(f_l - f_u)\Delta t = (\rho_0 c a_0 \Delta t)(2V_0\alpha)$$

and, converting to lift coefficient,

$$c_l = \frac{f_l - f_u}{\frac{1}{2}\rho_0 V_0^2 c} = \frac{4a_0\alpha}{V_0} = \frac{4\alpha}{M}$$

Since the force is distributed uniformly along the chord this result is the equivalent of equation (11c).

In the development of the theory of plane waves of small amplitude (see, e.g., reference 7) Rayleigh and Lamb have shown that the energy in a wave is divided equally into kinetic and potential energy. Denoting kinetic energy by T ,

$$T = \frac{1}{2}\rho_0 \iiint w^2 dx dy dz$$

where w is the perturbation velocity within the wave. Since the energy induced in the wave must result from work done on the plate, it can be seen that

$$(f_l - f_u)V_0\alpha\Delta t = \frac{4}{2}\rho_0 \int_0^{a_0\Delta t} V_0^2\alpha^2 c dx$$

or

$$(f_l - f_u) \Delta t = 2\rho_0 V_0 \alpha c_a \Delta t$$

This equation is in agreement with the one obtained previously.

As a consequence of equation (11c) it follows that the starting lift coefficient of an airfoil is equal to $4\alpha/M$ for both subsonic and supersonic flight. The magnitude of c_l thus increases as M becomes smaller and for incompressible theory, where the velocity of sound is indefinitely large, must necessarily become infinite. This fact was known previously along with the understanding that the indicial lift function experiences an infinite discontinuity at $t = 0$. (See fig. 6.) For values of M other than zero the starting lift is finite and a continuous lift function results.

For a sudden gust with vertical velocity w_0 the following expressions can be found for the corresponding regions

Region A

$$\frac{\Delta p}{q} = \frac{4w_0}{V_0 \sqrt{M^2 - 1}} \quad (12a)$$

Region B

$$\frac{\Delta p}{q} = \frac{4w_0}{\pi V_0 \sqrt{M^2 - 1}} \arccos \frac{Mx+t}{x+Mt} \quad (12b)$$

Region C

$$\frac{\Delta p}{q} = 0 \quad (12c)$$

APPLICATIONS AND DISCUSSIONS

Discussion of Load Distributions

Figure 4 shows the variation of the loading on a section which, while traveling at supersonic speed, is suddenly deflected to a new angle of attack. The loading varies according to equation (11) for each of the three regions A, B, and C of figure 3. At $t = 0$ the pressure is discontinuous, jumping from its original value, just before the sudden deflection in angle of attack, to $4\alpha/M$ just after the deflection. Figure 3 shows, however, that the initial load distribution is modified over the forward portion of the section as time increases since regions A and B must be considered.

For $t > \frac{c}{M-1}$, the wing lies entirely in region A so that

$$\frac{\Delta p}{q} = \frac{4\alpha}{\sqrt{M^2-1}}$$

and the loading has attained a static value agreeing with the Ackeret type of distribution. The loading in region B varies between the two constant values of regions A and C, dipping below that of region C and having its minimum value at $x = 0$.

The loading produced upon entering a sharp-edged gust is pictured in figure 5. The loading in region C is zero, since that portion of the wing is unaware of the change in stream conditions. Over the forward portion of the airfoil (region A) the Ackeret type loading corresponding to the modified angle of attack is in evidence and for

$t > \frac{c}{M-1}$ extends over the entire chord of the wing. In region B

the loading experiences a reduction in magnitude from the value over the forward portion of the wing.

The load distributions which have been developed were obtained for flight velocities in the supersonic regime. It is apparent, however, that the basic differential equation is not restricted to the case where $M > 1$ and that the method of analysis affords a means whereby transient load effects can be studied for subsonic speeds. The essential difference between the latter problem and the results derived here lies in the relative position of leading- and trailing-edge traces in the x, t plane and the trace of the characteristic cone. Thus, for subsonic flight, the trace $x = -t$ does not cut across the region occupied by the airfoil; whereas the cone stemming from the trailing-edge point $c, 0$ does. A qualitative picture of the problem is obtained if the analogy between the non-steady two-dimensional case and three-dimensional wing theory is used. The loading functions given in equation (11) are equivalent to loading existing on a swept-forward tip of a three-dimensional wing. Thus, in figure 1(a), x can represent distance measured spanwise, t can represent distance measured chordwise, and the shaded area can represent a portion of the plan form of the wing. Using this analogy, the loading which has been determined is merely load distribution over the swept-forward tip of a wing with constant chord and supersonic leading edge. When the case of the airfoil section traveling at subsonic speeds is to be considered, the problem becomes one of determining the loading over the swept-forward tip of a wing with constant chord and subsonic leading edge.

Development of Indicial Lift Functions

Since section lift coefficient, c_L , is given by the expression

$$c_L = \frac{1}{c} \int_0^c \frac{\Delta p}{q} dx$$

the relations presented in equations (11) and (12) are sufficient for the determination of $c_{L\alpha}$, indicial lift coefficient for change in angle of attack, and c_{Lg} , indicial lift coefficient for an airfoil entering a gust. As a result of direct integration, the following results are obtained.

First time interval $0 < t < \frac{c}{1+M}$

$$c_{L\alpha} = \frac{4\alpha}{M} \tag{13a}$$

$$c_{Lg} = \frac{4w_0 t}{cV_0} \tag{14a}$$

Second time interval $\frac{c}{1+M} < t < \frac{c}{M-1}$

$$c_{L\alpha} = \frac{4\alpha}{\pi} \left[\frac{1}{M} \left(\frac{\pi}{2} + \arcsin \frac{c-Mt}{t} \right) + \frac{1}{\sqrt{M^2-1}} \arccos \frac{t+Mc-tM^2}{c} + \frac{1}{Mc} \sqrt{t^2 - (c-tM)^2} \right] \tag{13b}$$

$$c_{Lg} = \frac{4w_0 t}{\pi V_0 c} \left(\frac{\pi}{2} + \arcsin \frac{c-Mt}{t} \right) + \frac{4w_0}{\pi V_0 \sqrt{M^2-1}} \arccos \frac{Mc+t^2-M^2t}{c} \tag{14b}$$

Third time interval $\frac{c}{M-1} < t$

$$c_{L\alpha} = \frac{4\alpha}{\sqrt{M^2-1}} \tag{13c}$$

$$c_{Lg} = \frac{4w_0}{V_0 \sqrt{M^2-1}} \tag{14c}$$

Values of the lift functions are plotted in figure 6 as functions of s , the distance traveled by the airfoil measured in half-chord lengths where $s = \frac{2Mt}{c}$. The curves shown were calculated for values of M equal to 1.2, 1.31, and 1.46, since the asymptotic values of $c_{L\alpha}$ and c_{Lg} for the three cases agree with the values given in reference 1 for the subsonic wing at aspect ratios of ∞ , 6, and 3, respectively. No direct analogy, of course, can be made between the two cases. It is, however, worthy of note that the variations in the indicial functions for the supersonic case are of the same order of magnitude as those found in the finite-span incompressible case.

From a knowledge of the lift function resulting from a sudden unit angle of attack, it is possible to express the lift corresponding to a given variable motion by considering the given motion as being composed of infinitesimal steps and summing the lifts corresponding to each step. Mathematically, the problem corresponds to the use of the indicial admittance in determining the current response for an electric network and leads to the so-called superposition theorem which can be written in the form

$$\begin{aligned} c_L(t') &= \alpha(0) c_{L\alpha}(t') + \int_0^{t'} c_{L\alpha}(t'-\tau') \frac{d\alpha(\tau')}{d\tau'} d\tau' \\ &= \frac{d}{dt'} \int_0^{t'} c_{L\alpha}(t'-\tau') \alpha(\tau') d\tau' \end{aligned} \quad (15)$$

The primes on the variables in this equation indicate that true time is used.

Motion of Airfoil in Gust

The results which have been obtained will now be applied to determine the forces on an unrestrained airfoil entering a gust. Since the motion of the wing is not prescribed it becomes necessary to equate the dynamical forces in order to relate the variables involved. Neglecting pitching moment and using Newton's second law of motion,

$$m \frac{dw}{dt'} = \sum \text{forces} \quad (16)$$

where w is the vertical velocity of the wing, m is the mass of the wing, and the forces to be summed result from the lift on the

wing and the impressed force resulting from the action of the gust. By means of equation (15), equation (16) can be rewritten in the form

$$m \frac{dw}{dt'} + qS \frac{d}{dt'} \int_0^{t'} c_{L\alpha} (t' - \tau') \alpha(\tau') d\tau' = \frac{w_0}{V_0} c_{Lg} (t') qS \quad (17)$$

Introducing a change of variables such that

$$T = \frac{t'}{c} a_0, \quad T_1 = \frac{\tau'}{c} a_0$$

and setting

$$\frac{w}{V} = \alpha, \quad \mu = \frac{2m}{\rho_0 M S c}$$

the equation becomes, finally,

$$\mu \frac{d\alpha}{dT} + \frac{d}{dT} \int_0^T c_{L\alpha} (T - T_1) \alpha (T_1) dT_1 = \frac{w_0}{V_0} c_{Lg} (T) \quad (18)$$

Since $\alpha(0) = 0$, equation (18) can be integrated to give:

$$\alpha - \frac{w_0}{V_0} \frac{1}{\mu} \int_0^T c_{Lg} (T_1) dT_1 + \frac{1}{\mu} \int_0^T c_{L\alpha} (T - T_1) \alpha (T_1) dT_1 = 0 \quad (19)$$

which is an integral equation of the second kind with a variable upper limit. The solution to this equation can be obtained quite satisfactorily by means of Liouville's method of successive substitution. Using the relation $c_L = \mu \frac{d\alpha}{dT}$ and performing the proper manipulations gives:

$$\begin{aligned} \frac{V_0}{w_0} c_L = c_{Lg} (T) - \frac{1}{\mu} \int_0^T c_{L\alpha} (T - T_1) c_{Lg} (T_1) dT_1 \\ + \frac{1}{\mu^2} \int_0^T c_{L\alpha} (T - T_1) dT_1 \int_0^{T_1} c_{L\alpha} (T_1 - T_2) c_{Lg} (T_2) dT_2 - \dots \quad (20) \end{aligned}$$

Equation (20) is known to converge uniformly for $T < \frac{\mu \sqrt{M^2 - 1}}{4}$

and in the applications of this report the maximum lift was always experienced in the region of convergence.

The values of lift coefficient c_L determined from the solution of equation (20) are shown in figures 7(a), 7(b), and 7(c) for

various values of μ and for $M = 1.2, 1.31, \text{ and } 1.46$. Figure 8 shows the variation of the maximum lift coefficient attained plotted as a function of the density parameter μ for the same three values of M . Figure 9 furnishes a comparison between the maximum lift-coefficient increment given in reference 1 for an aspect ratio of 6 and the corresponding value calculated in the present report for

$M = 1.31$. The results are plotted as functions of $\mu_j = \frac{4m}{\rho S c}$ to correspond with the density parameter used by Jones. The correspondence which was noted for the indicial lift functions with Mach number replacing wing aspect ratio is still in evidence.

Forces Developed on Given Wing

As an example of the uses to which the results just obtained can be applied, consider an airplane with wing of plan form such as the one shown in figure 2. Assume a wing loading of 40 pounds per square foot, a chord length of 8 feet, and let it be specified that the wing is flying at a Mach number equal to 1.2 and that the wing is built to withstand forces producing accelerations between -3 and 5 times gravitational acceleration. It is proposed to find at what altitudes the wing may be subjected safely to a gust possessing a vertical velocity of 50 feet per second.

If F denotes total force on the wing,

$$F = W + L_g \quad (21)$$

where W is wing weight and L_g is the total lift produced by the gust. If $(\Delta C_L)_{\max}$ is the maximum increment in lift coefficient attained in a unit gust and A is the acceleration factor measured in multiples of g , then equation (21) is expressible in the form

$$A = 1 + (\Delta C_L)_{\max} \frac{w_0 S}{2 \bar{W}} \rho_0 V_0$$

Since it is required that $|A-1| \leq 4$, it follows that

$$(\Delta C_L)_{\max} \leq \frac{6.4}{\rho_0 V_0} \quad (22)$$

Figure 10 shows the limit curve of $(\Delta C_L)_{\max}$ plotted as a function of flight altitude. From a knowledge of $\mu = 2W/\rho_0 g M S c$, however,

the value of $(\Delta C_L)_{\max}$ actually attained by the wing entering the gust can be calculated. Such values are also included in figure 10 and indicate that, under the given conditions, the wing should not fly at an altitude less than approximately 28,000 feet.

Ames Aeronautical Laboratory,
National Advisory Committee for Aeronautics,
Moffett Field, Calif.

REFERENCES

1. Jones, Robert T.: The Unsteady Lift of a Wing of Finite Aspect Ratio. NACA Rep. No. 681, 1940.
2. Wagner, Herbert: Über die Entstehung des dynamischen Auftriebes von Tragflügeln. Z. F. a. M. M., Bd. 5, Heft 1, Feb. 1925, S. 17-35.
3. Theodorsen, Theodore: General Theory of Aerodynamic Instability and the Mechanism of Flutter. NACA Rep. No. 496, 1935.
4. Garrick, I. E., and Rubinow, S. I.: Flutter and Oscillating Air-Force Calculations for an Airfoil in a Two-Dimensional Supersonic Flow. NACA TN No. 1158, 1946.
5. Garrick, I. E., and Rubinow, S. I.: Theoretical Study of Air Forces on an Oscillating or Steady Thin Wing in a Supersonic Main Stream. NACA TN No. 1383, 1947.
6. Heaslet, Max. A., and Lomax, Harvard: The Use of Source-Sink and Doublet Distributions Extended to the Solution of Arbitrary Boundary Value Problems in Supersonic Flow. NACA TN No. 1515, 1947.
7. Lamb, Horace: Hydrodynamics. Dover Publications, 1945.

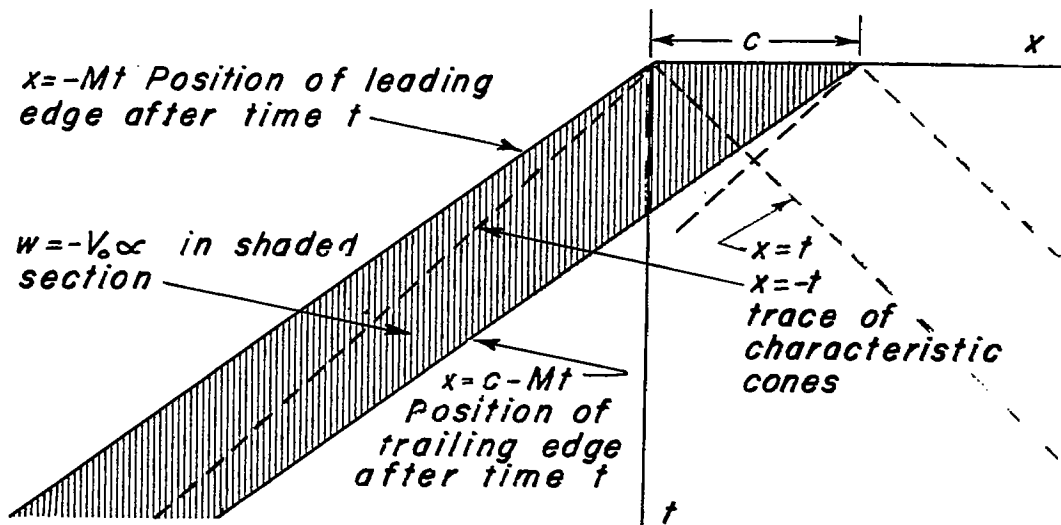

(a) Supersonic wing after a sudden angle of attack change.

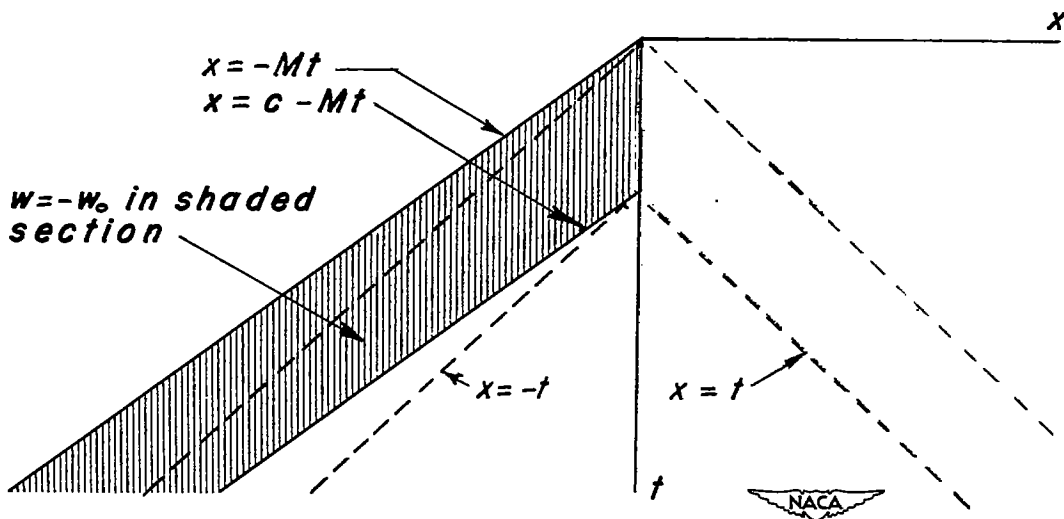

(b) Supersonic wing entering a sharp edged gust at $x = 0$

Figure 1. - Boundary conditions for supersonic wings.

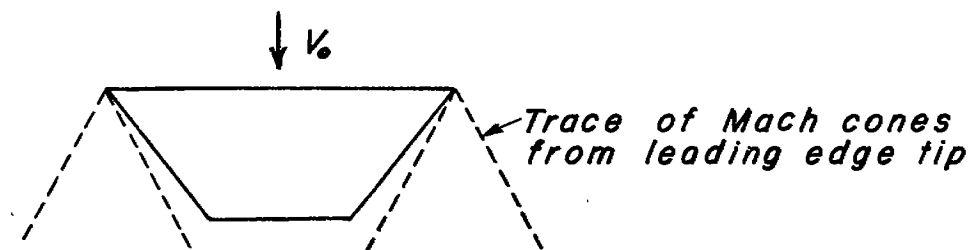

Figure 2.- Type of plan form studied in analysis.

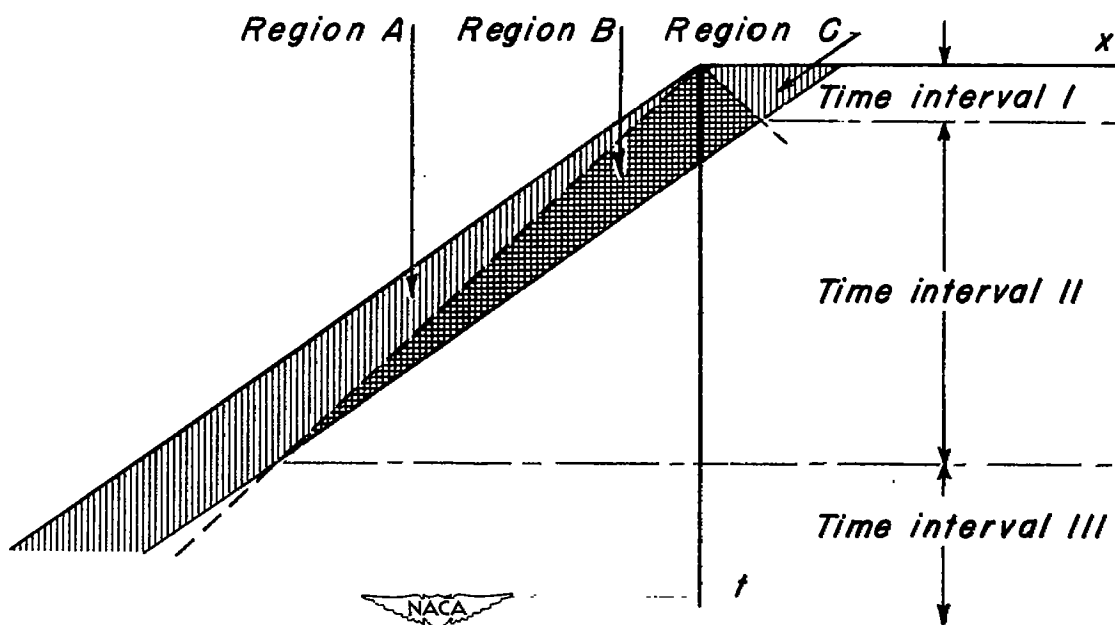
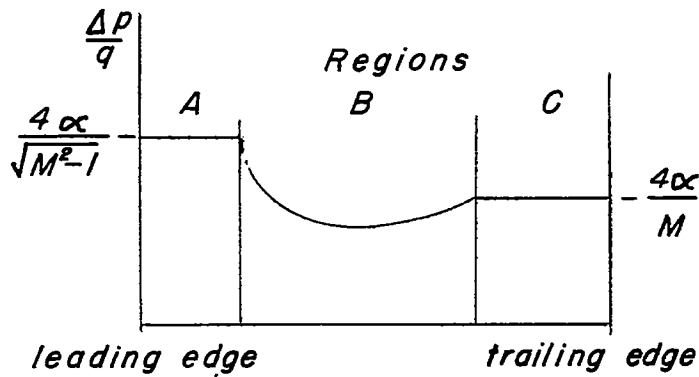
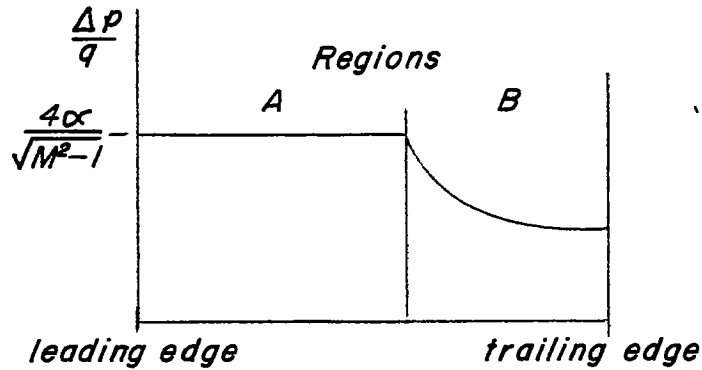

Figure 3.- Sketch indicating locations of regions A, B and C and time intervals used in analysis.



(a) Time interval I, $0 < t/c < 1/(M+1)$



(b) Time interval II, $1/(M+1) < t/c < 1/(M-1)$

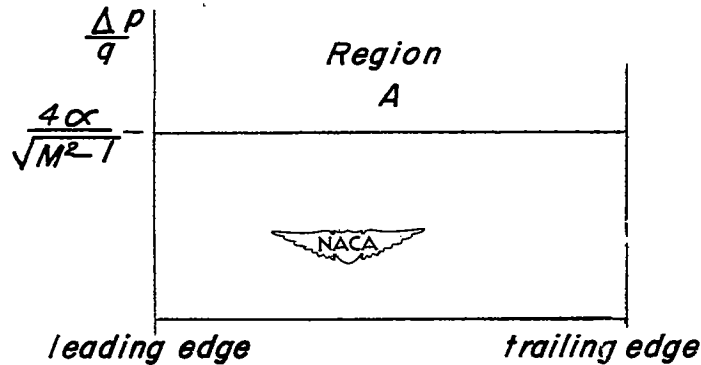

(c) Time interval III, $1/(M-1) < t/c$

Figure 4.—Variations of $\Delta p/q$ with chordwise station after sudden change in angle of attack. Regions defined in figure 3.

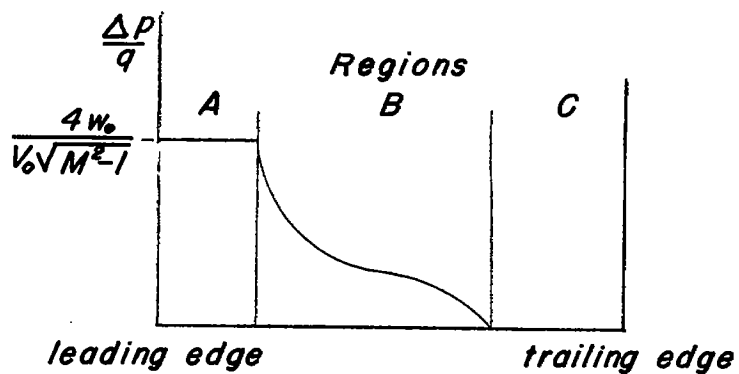

(a) Time interval I, $0 < t/c < 1/(M+1)$

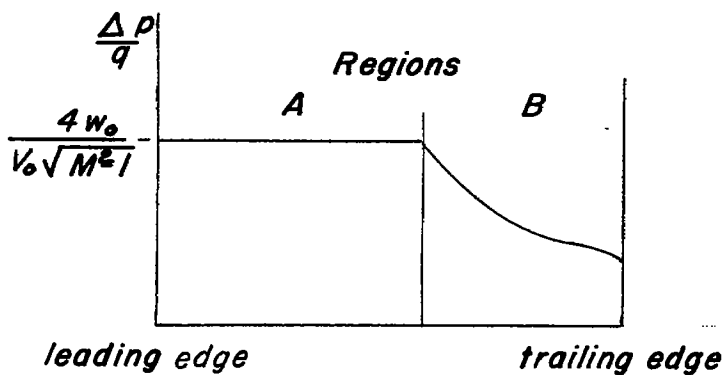

(b) Time interval II, $1/(M+1) < t/c < 1/(M-1)$

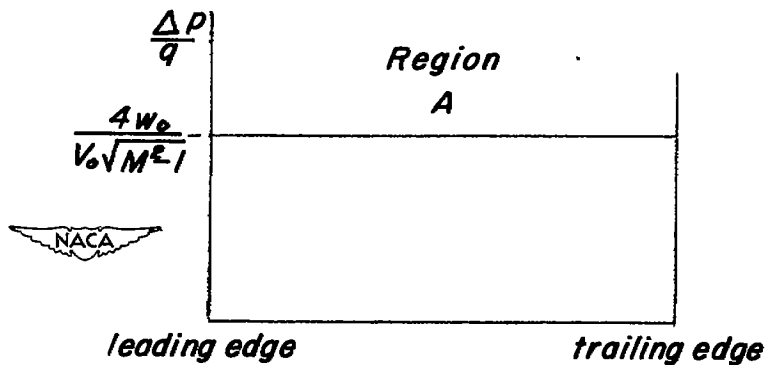

(c) Time interval III, $1/(M-1) < t/c$

Figure 5.-Variation of $\Delta p/q$ with chordwise station after entering gust. Regions defined in figure 3.

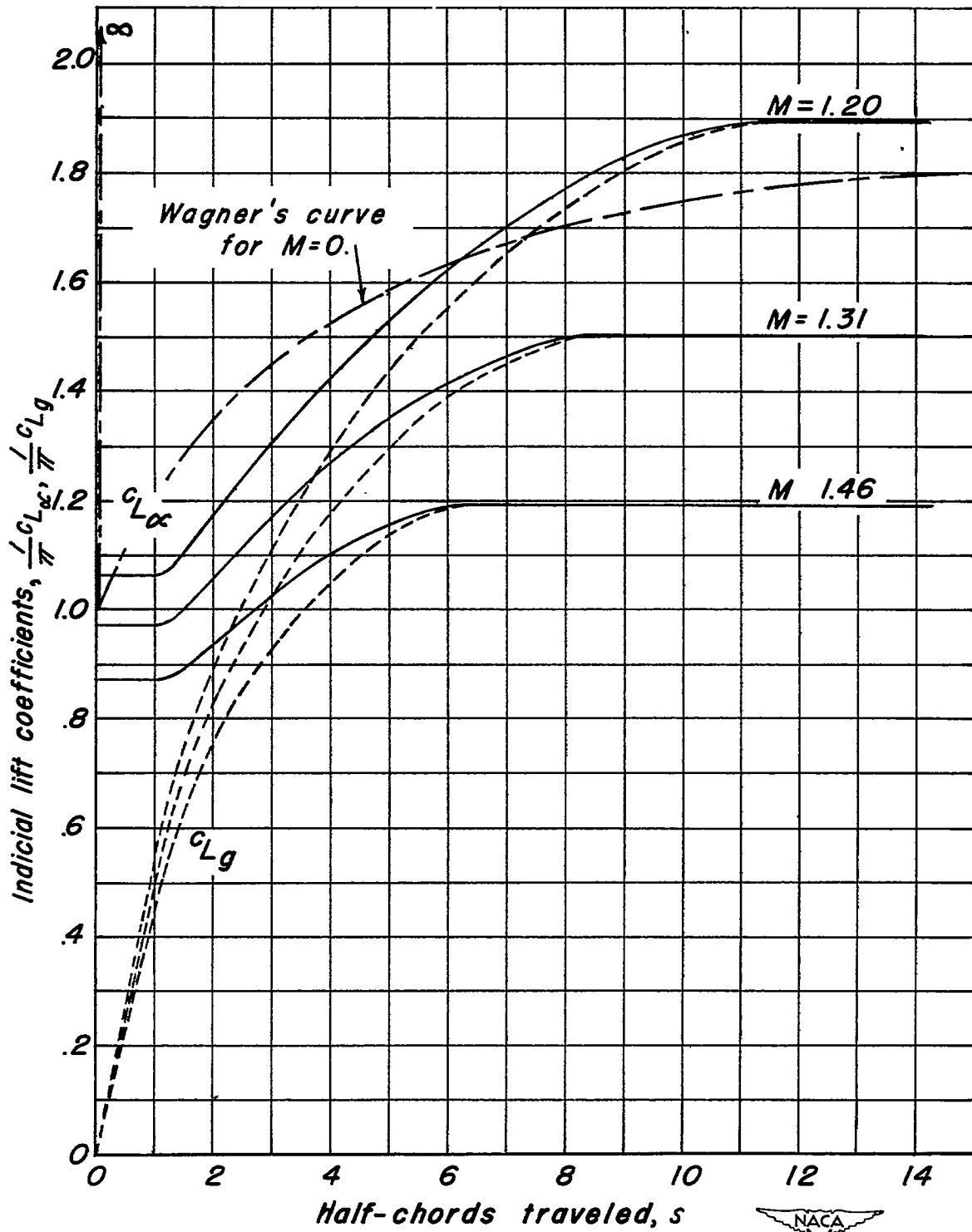

Figure 6.- Indicial lift functions $c_{L\alpha}(s)$ and $c_{Lg}(s)$ for various free stream Mach numbers.



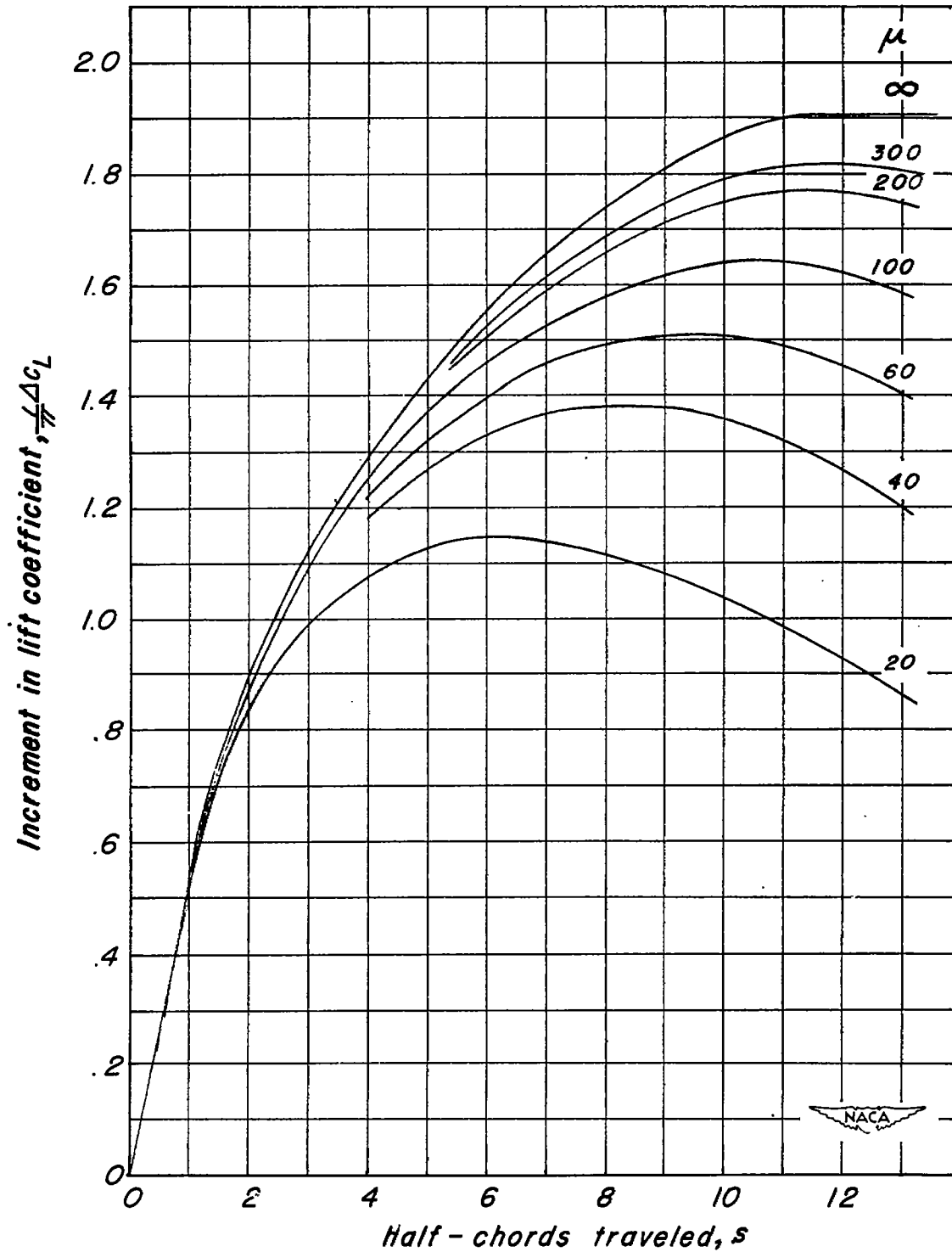

Figure 7. - Variation of increment of lift coefficient during flight through unit sharp-edged gust. (a) $M=1.20$.

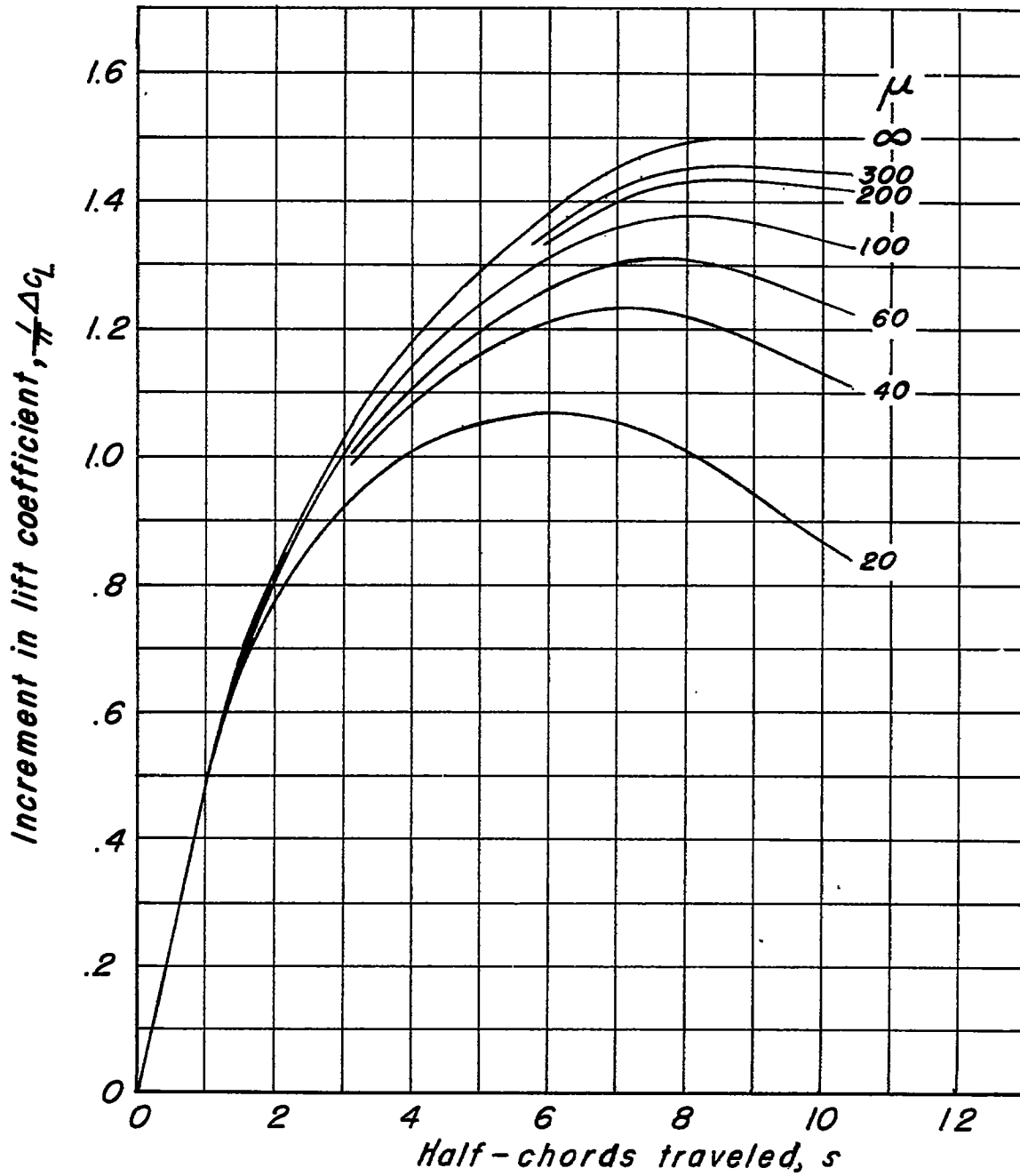

Figure 7.-Continued. (b) $M=1.31$



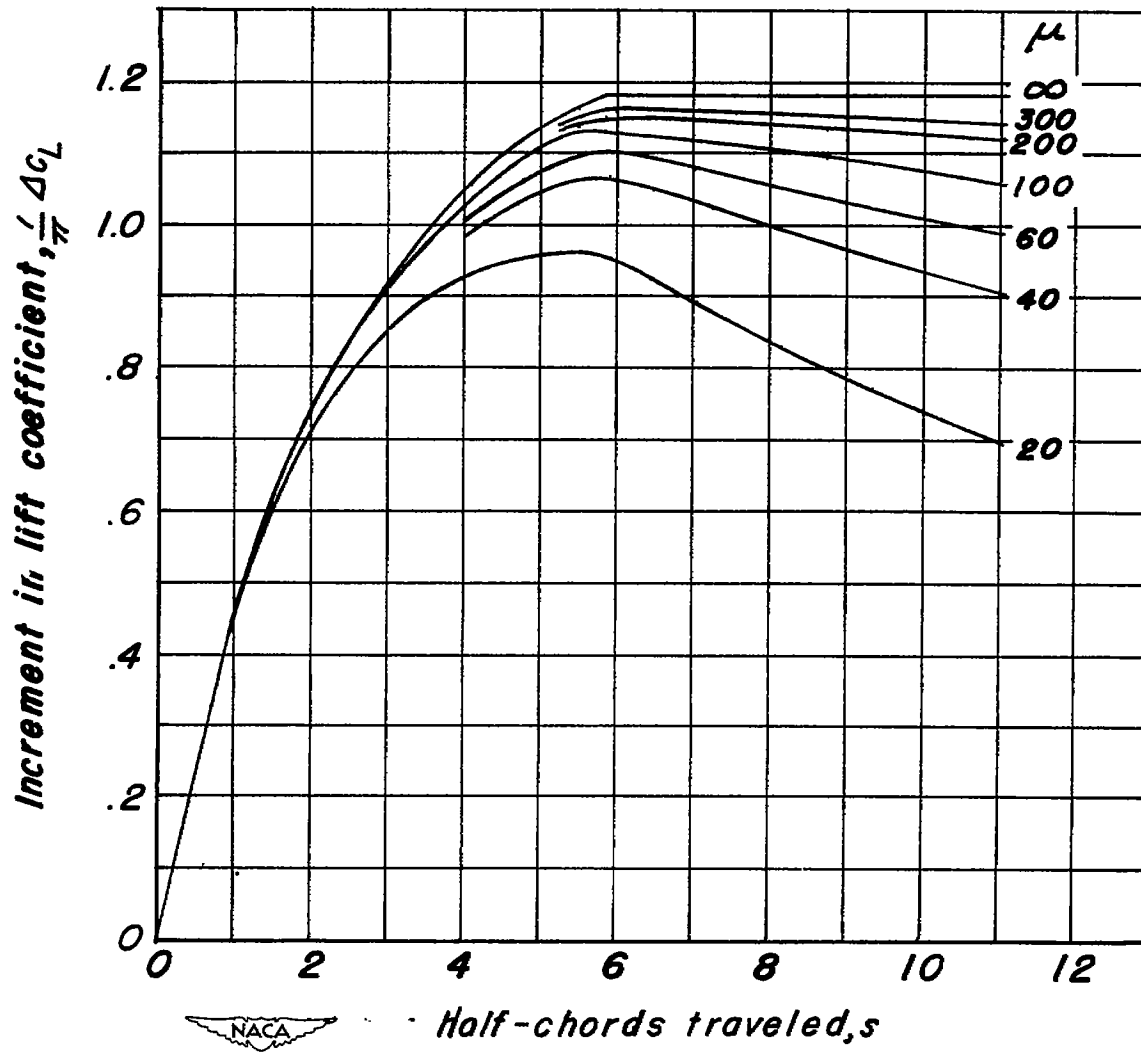

Figure 7.- Concluded. (c) $M=1.46$

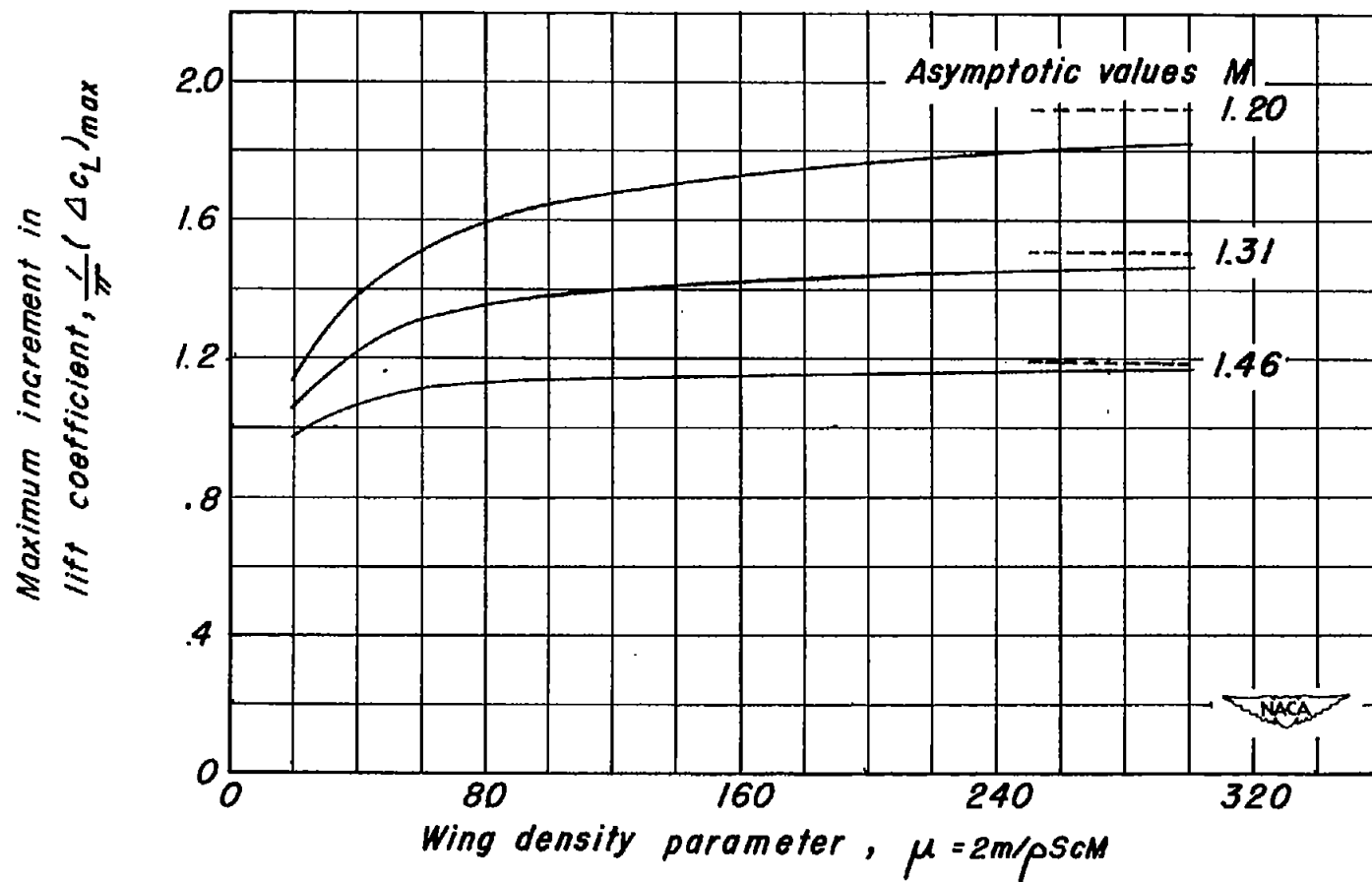

Figure 8.— Maximum increment in lift coefficient attained during flight through unit sharp-edged gust for various values of free-stream Mach number, M .

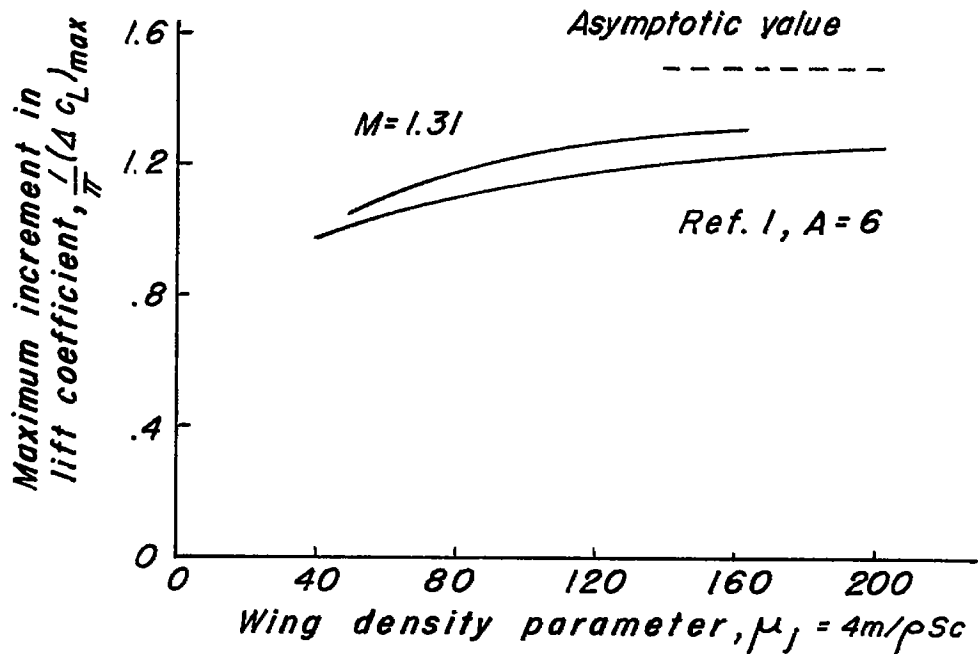

Figure 9.—Comparison of maximum increments in lift coefficients during flight through sharp-edged gust between subsonic wing and supersonic wing.

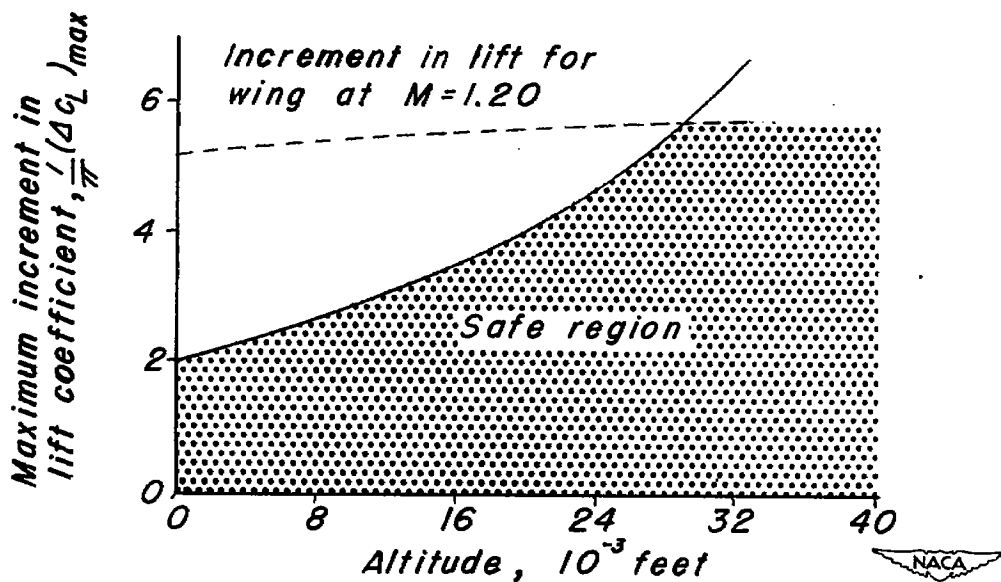

Figure 10.— Safe altitudes for wing with loading of 40 lb/ft² flying at M=1.20, based on 50 ft/sec. gust velocity and maximum load factors of 5g and -3g.