

~~RESTRICTED~~

COPY NO.

RM No. E8G02a

UNCLASSIFIED



RESEARCH MEMORANDUM

INVESTIGATION OF THE I-40 JET-PROPULSION ENGINE IN THE
CLEVELAND ALTITUDE WIND TUNNEL

II - ANALYSIS OF COMPRESSOR PERFORMANCE
CHARACTERISTICS

By Robert O. Dietz, Jr. and Robert M. Geisenheyner

Flight Propulsion Research Laboratory

Cleveland, Ohio

CLASSIFICATION CANCELLED

Authority J. W. Crowley Date 12-14-54

2010501

By J. K. - 1-25-54

RF1950

See CLASSIFIED DOCUMENT

This document contains classified information affecting the National Defense of the United States within the meaning of the Espionage Act, USC 50:31 and 32. Its transmission or the revelation of its contents in any manner to an unauthorized person is prohibited by law. Information so classified may be imparted only to persons in the military and naval services of the United States, appropriate civilian officers and employees of the Federal Government who have a legitimate interest therein, and to United States citizens of known loyalty and discretion who of necessity must be informed thereof.

**NATIONAL ADVISORY COMMITTEE
FOR AERONAUTICS**

WASHINGTON
August 26, 1948

NACA LIBRARY
LANGLEY AERONAUTICAL LABORATORY
Langley Field, Va.

~~RESTRICTED~~
UNCLASSIFIED



3 1176 01435 5474

NACA RM No. E8G02a

~~RESTRICTED~~

UNCLASSIFIED

NATIONAL ADVISORY COMMITTEE FOR AERONAUTICS

RESEARCH MEMORANDUMINVESTIGATION OF THE I-40 JET-PROPULSION ENGINE IN THE
CLEVELAND ALTITUDE WIND TUNNEL

II - ANALYSIS OF COMPRESSOR PERFORMANCE CHARACTERISTICS

By Robert O. Dietz, Jr. and Robert M. Geisenheyner

SUMMARY

Performance characteristics of the centrifugal compressor of the I-40 jet-propulsion engine were determined with the engine installed in an airplane fuselage in the Cleveland altitude wind tunnel. A standard I-40 turbojet engine was used in the investigation, which was conducted over a range of simulated altitudes from 10,000 to 40,000 feet and ram pressure ratios from 0.98 to 1.76. During the investigation the compressor Mach number varied from 0.72 to 1.46. Performance characteristics are presented as functions of corrected air flow and compressor Mach number.

From results obtained over a wide range of altitudes, it was determined that the compressor performance is primarily dependent on the compressor-inlet Mach number. Variations of Reynolds number of the air at the compressor inlet had little effect on compressor performance. At low compressor Mach numbers, increased ram pressure ratios so shifted the compressor operating line that lower compressor pressure ratio, compressor efficiency, and compressor pressure coefficient were obtained at a given corrected air flow. At high compressor Mach numbers, the effect of ram pressure ratio was negligible. The maximum compressor efficiency obtained was 72 percent at static conditions. At a corrected engine speed of 11,500 rpm, the compressor efficiency was 69 percent, the corrected compressor air flow was 77 pounds per second, the compressor pressure ratio was 3.95, and the compressor pressure coefficient was 0.65. Special attempts to produce compressor surge were unsuccessful.

INTRODUCTION

An investigation of the I-40 jet-propulsion engine installation in an airplane fuselage has been conducted in the Cleveland altitude wind tunnel. Over-all engine characteristics of the installation are presented in reference 1.

~~RESTRICTED~~

UNCLASSIFIED

One of the objectives of the investigation was to investigate the compressor characteristics and determine how effectively the compressor operated in this engine. The over-all efficiency of a turbojet engine is directly dependent on the separate efficiencies of its component parts. In order to obtain the maximum possible efficiency from the engine, the compressor must therefore be operated as near peak efficiency as possible. An analysis of the performance characteristics of the I-40 compressor is presented. The compressor characteristics are presented as functions of corrected air flow and compressor Mach number.

Wind-tunnel investigations of this compressor installed in the I-40 engine were made at simulated altitudes ranging from 10,000 to 40,000 feet and ram pressure ratios from 0.98 to 1.76. The compressor Mach number varied from 0.72 at minimum engine speeds to 1.46 at maximum engine speed.

DESCRIPTION OF COMPRESSOR

The I-40-3 compressor is a double-inlet centrifugal-type consisting of three principal parts: the impeller, the diffuser, and the casing.

The 31-blade double-entry impeller (fig. 1) has two sets of blades that discharge into a common diffuser. The outlet diameter of the impeller is 30 inches and the ratio of outlet-to-inlet diameter is 3.5. The impeller-hub length is 11 inches and the over-all width of the impeller at the blade tip is 2.75 inches. The impeller is secured by bolts between two flanged shafts and rotates on a ball thrust bearing at the front and a roller bearing at the rear (fig. 2). Front and rear impeller-face clearances are 0.045 and 0.055 inch, respectively. The impeller-annulus mean clearances at front and rear are 0.039 and 0.061 inch, respectively.

The diffuser has 14 vanes, equally spaced around the compressor periphery (fig. 3), which direct the air into 14 air adapters leading to the combustion chambers. Diffuser elbows, containing four turning vanes each, so direct the air flow that it enters the combustion chambers axially. The compressor casing, which has smooth interior surfaces, is bolted to the diffuser.

Protective 5-mesh screens made of 0.036-inch-diameter wire were installed over each compressor inlet. The combined inlet area, front and rear, to the compressor measured at the screens is approximately 6.53 square feet. The compressor-outlet area, measured at the point of instrumentation, station 4 (fig. 4), is approximately 1.62 square feet.

The compressor was designed to develop a pressure ratio of 4 with an air flow of 80 pounds per second at an engine speed of 11,500 rpm at sea level.

INSTALLATION

The I-40 engine installed in the airplane fuselage was mounted in the 20-foot-diameter test section of the Cleveland altitude wind tunnel. Air entered the airplane through inlets on both sides of the fuselage near the wing fillets and flowed through ducts into the plenum chamber surrounding the engine. The air then entered the openings of the double-entry compressor (fig. 4).

Two configurations were used to simulate static and flight conditions. For static tests, air was taken from the tunnel test section through the airplane inlet ducts; for flight conditions, air was conducted from the tunnel make-up air system to the airplane inlet ducts through a Y-shaped ram duct. The air flow in the ram duct was regulated by means of a butterfly valve located approximately 147 feet upstream of the inlet ducts. This air was throttled from approximately sea-level pressure to the pressure corresponding to the desired ram pressure ratio at the desired altitude.

The airplane installation also includes a tail pipe 19 inches in diameter and 93 inches long.

INSTRUMENTATION

The engine was extensively instrumented as shown in figure 5. The compressor instrumentation was located at stations 2, 3, and 4 and the tail-pipe instrumentation at station 8 (fig. 4).

The front compressor-inlet instrumentation (station 2) consisted of 14 total-pressure tubes and 7 thermocouples. The rear compressor-inlet instrumentation (station 2) consisted of 28 total-pressure tubes and 14 thermocouples. The instrumentation was mounted on the engine truss-ring support and equally spaced over a surface 3 inches above the compressor-inlet screens.

During one phase of the investigation, three rakes of five total-pressure tubes each and one rake of five static-pressure tubes were placed immediately forward of the impeller in the front compressor inlet. One of these rakes is shown at station 3 in figure 5. The rakes were located at approximately 90° intervals.

The compressor-outlet instrumentation consisted of three rakes of five total-pressure tubes and four thermocouples placed diagonally across three air adapters equally spaced circumferentially around the engine. The tail-pipe-nozzle outlet instrumentation was composed of a rake of 18 total-pressure tubes, 3 static-pressure tubes, and 10 thermocouples. Two sets of static-wall orifices were placed 90° apart around the periphery of the tail pipe 1 inch upstream of the outlet end of the tail pipe.

TEST CONDITIONS

Investigations were conducted at simulated altitudes of 10,000, 20,000, 30,000, and 40,000 feet and ram pressure ratios of 0.98, 1.09, 1.20, 1.32, 1.53, and 1.76. The total pressure in the engine plenum chamber was maintained at the proper value to simulate a desired ram pressure ratio at a given simulated altitude. NACA standard conditions of temperature were reasonably maintained in the tunnel test section and the engine plenum chamber for each simulated altitude and ram condition. For each condition of altitude and ram pressure ratio, the engine was run over its full range of operable speeds.

During static conditions, velocities from 76 to 127 feet per second were induced in the tunnel test section by the ejector effect of the jet and by the tunnel exhaust scoop, which was located in the air stream immediately downstream of the test section.

SYMBOLS

The symbols and the necessary values used in this report are:

A	area, (sq ft)
a	speed of sound in air, (ft/sec)
c_p	specific heat of gas at constant pressure, (0.241 Btu/lb/°R)
D	diameter of rotor, (ft)
g	acceleration due to gravity, (ft/sec ²)
J	mechanical equivalent of heat, (778 ft-lb/Btu)
K_g	gas-flow calibration factor for tail-pipe-nozzle outlet rake, (0.964)

M_c	compressor Mach number
N	engine speed, (rpm)
P	total pressure, (lb/sq ft absolute)
p	static pressure, (lb/sq ft absolute)
R	gas constant
T	total temperature, ($^{\circ}R$)
T_i	indicated temperature, ($^{\circ}R$)
t	static temperature, ($^{\circ}R$)
U_t	rotor tip speed, (ft/sec)
W	weight flow, (lb/sec)
α	thermocouple impact-recovery factor, (0.86)
γ	ratio of specific heats, (c_p/c_v)
θ	ratio of absolute compressor-inlet total temperature and NACA standard sea-level temperature ($T_2/519$)
δ	ratio of compressor-inlet total pressure and NACA standard sea-level pressure
η_c	compressor efficiency, (percent)
ψ	compressor pressure coefficient

Subscripts:

0	ambient, or free-stream, conditions
2	average compressor inlet
3	compressor face
4	compressor outlet
5	turbine-nozzle inlet
8	tail-pipe-nozzle outlet

a	air
c	compressor
f	fuel
g	gas
n	turbine throat
s	tail-pipe-nozzle outlet shell
x	annular increment of area in tail-pipe-nozzle outlet

The following parameters are generalized to NACA standard atmospheric conditions at sea level:

$$\frac{W_a \sqrt{\theta}}{\delta} \quad \text{corrected air flow, (lb/sec)}$$

$$\frac{N}{\sqrt{\theta}} \quad \text{corrected engine speed, (rpm)}$$

METHODS OF CALCULATION

Ram Pressure Ratio

Ram pressure ratio is the ratio of the average of the front and rear compressor-inlet total pressures to the tunnel static pressure, P_2/P_0 .

Mach Number

The compressor Mach number is defined as the ratio of the tip speed of the compressor blades to the velocity of sound corresponding to the total temperature of the inlet air. Mach number is represented by the dimensionless ratio

$$M_c = \frac{U_t}{a_2} = \frac{\pi DN}{60 \sqrt{\gamma g R T_2}}$$

Temperatures

The compressor-outlet total temperature can be calculated from

$$T_4 = T_{i,4} + \frac{1 - \alpha}{2JgC_p} \left(\frac{R}{A_4}\right)^2 \left(\frac{W_a t_4}{P_4}\right)^2$$

Because compressor-outlet static pressure was not measured, indicated temperature and total pressure are used instead of static temperature and static pressure, respectively, in this equation. This substitution introduced a negligible error in the impact-recovery corrections. The thermocouple impact-recovery factor α was determined from calibration tests run on representative thermocouples of the type used.

The total temperature at the compressor inlet is assumed to be equal to the indicated temperature because the velocity at the compressor inlet is low. This assumption introduced an error of less than 0.2 percent.

Air Flow

Gas flow was calculated from tail-pipe-nozzle outlet (station 8) measurements of pressure and temperature. Because the surveys across the tail pipe were nonuniform, the area was divided into a series of annuli and the gas flow calculated through each annulus. A summation of these incremental gas flows is the total gas flow through the engine. The following equation was used:

$$W_g = \left\{ K_g P_8 \sqrt{\frac{2\gamma g}{(\gamma - 1)R}} \sum A_x \sqrt{\frac{\left[\left(\frac{P_x}{P_8}\right)^{\frac{\gamma-1}{\gamma}} - 1 \right] + \alpha \left[\left(\frac{P_x}{P_8}\right)^{\frac{\gamma-1}{\gamma}} - 1 \right]^2}{T_1}} \right\} C$$

where C is the correction factor for expansion of the tail pipe at high temperatures:

$$C = 1 + 1.8 \times 10^{-5} (T_s - 520)$$

A derivation of the gas-flow equation is presented in reference 1. Fuel flow was then subtracted from the gas flow in order to obtain the air flow:

$$W_a = W_g - W_f$$

Efficiency

The following equation was used in calculating compressor efficiency:

$$\eta_c = \frac{\left(\frac{P_4}{P_2}\right)^{\frac{\gamma-1}{\gamma}} - 1}{\frac{T_4}{T_2} - 1}$$

where the value of γ is assumed to be constant at 1.393.

Pressure Coefficient

The pressure coefficient is the ratio of the work of adiabatic compression between initial and final pressures and the theoretical work of adiabatic compression in a channel rotating with the same tip speed as the compressor tip speed. The equation for compressor pressure coefficient is

$$\psi = \frac{gJc_p}{U_t^2} T_2 \left[\left(\frac{P_4}{P_2}\right)^{\frac{\gamma-1}{\gamma}} - 1 \right]$$

RESULTS AND DISCUSSION

Method of Analysis

Complete compressor performance characteristics are usually presented by the use of the compressor pressure ratio and the corrected air flow as variables. A full range of operating characteristics such as determined from compressor dynamometer-rig investigations was impossible to obtain during altitude-wind-tunnel

$$C = 1 + 1.8 \times 10^{-5} (T_s - 520)$$

A derivation of the gas-flow equation is presented in reference 1. Fuel flow was then subtracted from the gas flow in order to obtain the air flow:

$$W_a = W_g - W_f$$

Efficiency

The following equation was used in calculating compressor efficiency:

$$\eta_c = \frac{\left(\frac{P_4}{P_2}\right)^{\frac{\gamma-1}{\gamma}} - 1}{\frac{T_4}{T_2} - 1}$$

where the value of γ is assumed to be constant at 1.393.

Pressure Coefficient

The pressure coefficient is the ratio of the work of adiabatic compression between initial and final pressures and the theoretical work of adiabatic compression in a channel rotating with the same tip speed as the compressor tip speed. The equation for compressor pressure coefficient is

$$\psi = \frac{gJc_p}{U_t^2} T_2 \left[\left(\frac{P_4}{P_2}\right)^{\frac{\gamma-1}{\gamma}} - 1 \right]$$

RESULTS AND DISCUSSION

Method of Analysis

Complete compressor performance characteristics are usually presented by the use of the compressor pressure ratio and the corrected air flow as variables. A full range of operating characteristics such as determined from compressor dynamometer-rig investigations was impossible to obtain during altitude-wind-tunnel

investigations of the complete engine because significant air-flow variation at a given speed was impossible. Performance characteristics were therefore determined only at conditions set by the overall operating characteristics of the complete engine and are presented in the form of an operating line. Figure 6 is an example of the operating line, which represents the relation between the compressor pressure ratio and corrected air flow when the engine speed is varied. The operating line may also be represented by the relation between compressor pressure ratio and compressor Mach number. Both representations of the operating line are presented herein.

The position of the operating line with respect to its coordinates is a function of the turbine-nozzle area and the ratio of the turbine-nozzle-inlet temperature to the compressor-inlet temperature, as will be shown. When the pressure ratio across a nozzle is above the critical value (approximately 1.89), the flow through the nozzle is approximately equal to

$$W_a = \frac{KA_n P_5^{\gamma_5}}{\sqrt{T_5}}$$

where K is a constant.

From the foregoing equation and the definitions of δ and θ , the corrected air flow in the critical-pressure range is approximately equal to

$$\frac{W_a \sqrt{\theta}}{\delta} = K_1 A_n \frac{P_5^{\gamma_5}}{P_2} \sqrt{\frac{T_5}{T_2}}$$

where K_1 is a constant. Inasmuch as the total-pressure drop across the combustion chambers is small, P_5/P_2 is very nearly equal to the compressor pressure ratio P_4/P_2 , and from the preceding discussion apparently the only operational variable that affects the relation between the corrected air flow and the compressor pressure ratio is the ratio of the temperature of the gases at the turbine inlet to the temperature of the air at the compressor inlet. In addition to the foregoing factor, the back pressure on the turbine nozzle affects the air flow when the pressure across the nozzle is less than the critical value.

The performance characteristics presented were determined from instrumentation located above the compressor-inlet screens. This method of determination penalized the compressor for losses through the inlet screens and the compressor-inlet ducts. These losses, determined from the compressor-face instrumentation, varied from 3 percent of the absolute total pressure at maximum engine speed to a negligible amount at low engine speeds. The decrease in compressor efficiency resulting from the inclusion of the inlet screen and inlet ducting as part of the compressor amounted to about 2 percent at maximum engine speed.

Position of Compressor Operating Line

Compressor performance data taken at several altitudes are generalized by applying correction factors that account for variations in Mach number of the air stream at the compressor inlet. When the data were generalized in this manner the compressor operating line was found to be independent of variations in altitude (fig. 6). The correspondence among the results when corrected for changes in the Mach number that accompany changes in altitude show that the variations in the Reynolds number, which also accompany changes in altitude, have little or no effect on the I-40 compressor performance. The double abscissa scale on figure 6 indicates the relation between compressor Mach number and corrected engine speed.

At low compressor Mach numbers, an increase in ram pressure ratio at a given corrected air flow caused a decrease in the compressor pressure ratio and a shift in the operating line to the right with respect to the coordinates (fig. 7). At high compressor Mach numbers, the effect of increased ram pressure ratio was negligible.

Compressor Efficiencies

The altitude effect (Reynolds-number effect) on compressor efficiency is negligible as shown in figure 8(a). A maximum compressor efficiency of 72 percent was obtained at static conditions (fig. 8(b)). This value was maintained from minimum corrected air flow to a corrected air flow of about 70 pounds per second, where it began to decrease gradually. These corrected air flows correspond to minimum compressor Mach number and a compressor Mach number of 1.12, respectively. An increase in ram pressure ratio at low corrected air flows (low compressor Mach numbers) decreased the efficiency. At high corrected air flows, ram pressure ratio had a very slight effect on efficiency.

The compressor efficiency characteristics are presented in figure 9. This curve is constructed from the operating lines presented in figure 7 and the efficiencies presented in figure 8. The operating line appears to pass to the high-air-flow side of the region of maximum efficiency on the efficiency-contour plot.

Pressures

The relation among compressor pressure ratio, compressor Mach number, corrected engine speed, and corrected air flow has been discussed. The maximum pressure ratio across the compressor was 4.55. At this pressure ratio, the corrected air flow was about 83 pounds per second and the compressor Mach number was 1.45.

Compressor pressure coefficients are presented in figures 10 and 11 in the same manner that the compressor efficiencies are presented in figures 8 and 9. The altitude effect on the relation between compressor pressure coefficient and corrected air flow was negligible (fig. 10(a)). Figure 10(b) shows that an increase in ram pressure ratio caused a decrease in the pressure coefficient at low corrected air flows (low compressor Mach numbers); however, at high corrected air flows (high compressor Mach numbers) the ram pressure effect on compressor pressure coefficient was negligible. The maximum pressure coefficient obtained for the compressor was 0.65 (fig. 10). The pressure coefficient was practically constant at this value at static conditions throughout the full range of investigations.

The contours of the constant-pressure coefficients presented in figure 11 show that the compressor operating line for a ram pressure ratio of 0.98 coincides with the maximum pressure-coefficient contour of 0.65.

A total-pressure survey across three air adapters (station 4), conducted at eight different engine speeds varying from the lowest operable speed to a maximum speed of 11,500 rpm, showed constant pressure distribution across each air adapter as well as negligible pressure variation from one adapter to another.

Performance at Corrected Engine Speed of 11,500 rpm

At a corrected engine speed of 11,500 rpm, the compressor pressure ratio was 3.95 and the corrected air flow was 77 pounds per second. At these conditions the compressor efficiency was 69 percent and the compressor pressure coefficient was 0.65.

Compressor surge, which is indicated by intermittent reversal of flow at the compressor outlet, was not encountered at normal engine operating conditions. Attempts to produce compressor surge at low altitudes and low temperatures were unsuccessful.

SUMMARY OF RESULTS

The results from the investigation of the performance of the centrifugal compressor in the I-40 jet-propulsion engine are summarized as follows:

1. From results obtained over a wide range of altitudes it was determined that the compressor performance is primarily dependent on the compressor-inlet Mach number. Variations of Reynolds number in the air at the compressor inlet that accompany changes in altitude have no appreciable effect on the relation among corrected air flow, compressor pressure ratio, compressor Mach number, compressor efficiency, and compressor pressure coefficient.

2. Increased ram pressure ratio at low compressor Mach numbers caused a shift in the compressor operating line so that a decrease in compressor efficiency, compressor pressure coefficient, and compressor pressure ratio occurred at a given corrected air flow. At high compressor Mach numbers, ram-pressure-ratio effects were negligible.

3. A maximum compressor efficiency of 72 percent was obtained at static conditions. This value was practically constant from the minimum compressor Mach number to a Mach number of 1.12, where the efficiency began to decrease. At high compressor Mach numbers, increasing the ram pressure ratio had a negligible effect on efficiency, but at low compressor Mach numbers the efficiency decreased with increasing ram.

4. The maximum pressure ratio obtained was 4.55. The corrected air flow at this pressure ratio was approximately 83 pounds per second and the compressor Mach number was 1.45.

5. The maximum compressor pressure coefficient obtained in the investigations was 0.65. The pressure coefficient remained practically constant at this value at static conditions throughout the full range of investigation. Ram pressure ratio had a negligible effect on compressor pressure coefficient at high compressor Mach numbers, but at low compressor Mach numbers the compressor pressure coefficient decreased with an increase in ram pressure.

6. At a corrected engine speed of 11,500 rpm, the compressor pressure ratio was 3.95 and the corrected air flow was 77 pounds per second. At these conditions the compressor efficiency was 69 percent and the compressor pressure coefficient was 0.65. At low altitudes and temperature, special attempts to make the compressor surge were unsuccessful.

Flight Propulsion Research Laboratory,
National Advisory Committee for Aeronautics,
Cleveland, Ohio.

REFERENCE

1. Gendler, Stanley L., and Koffel, William K.: Investigation of the I-40 Jet-Propulsion Engine in the Cleveland Altitude Wind Tunnel. I - Performance and Windmilling Drag Characteristics. NACA RM No. E8G02, 1948.

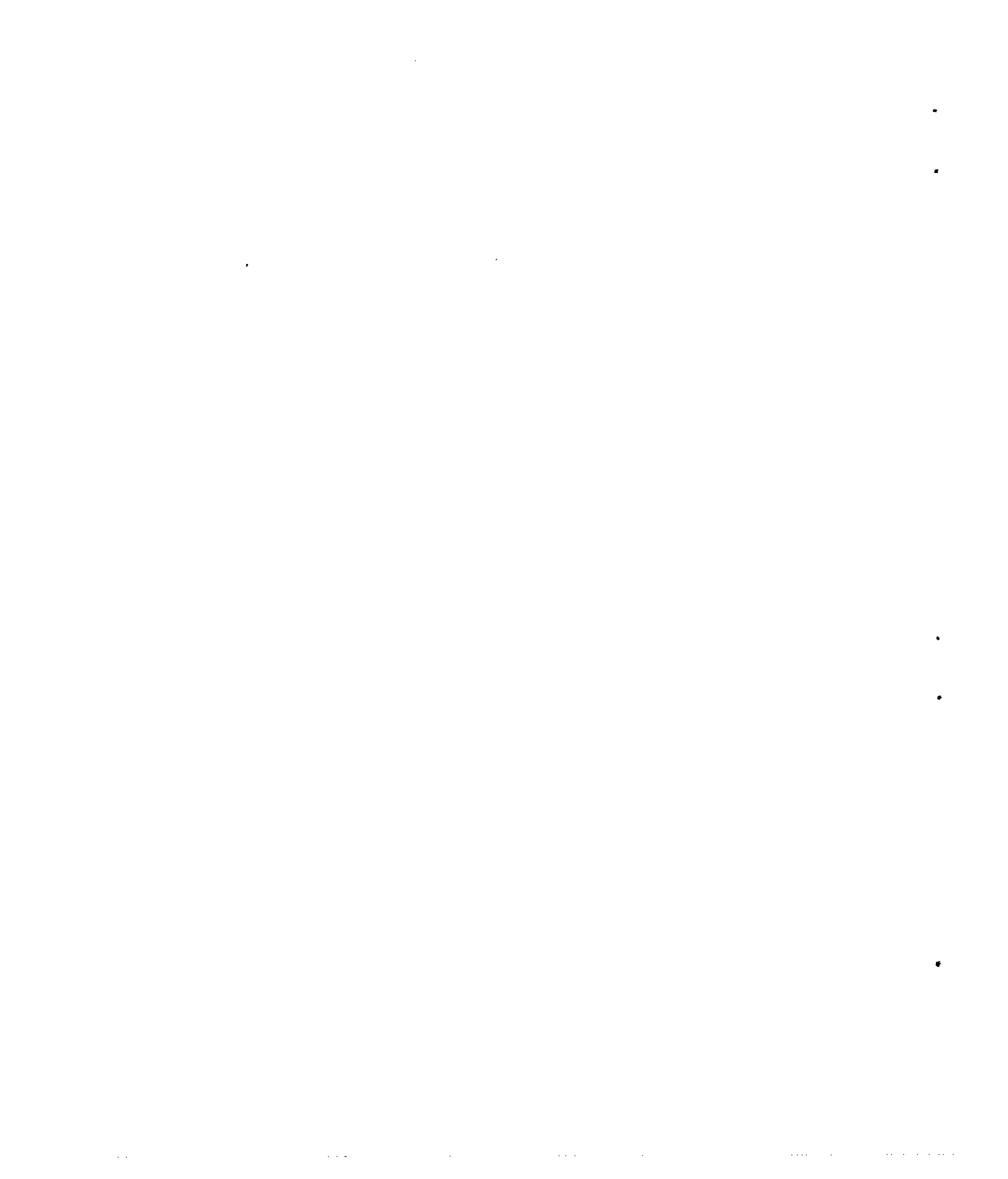

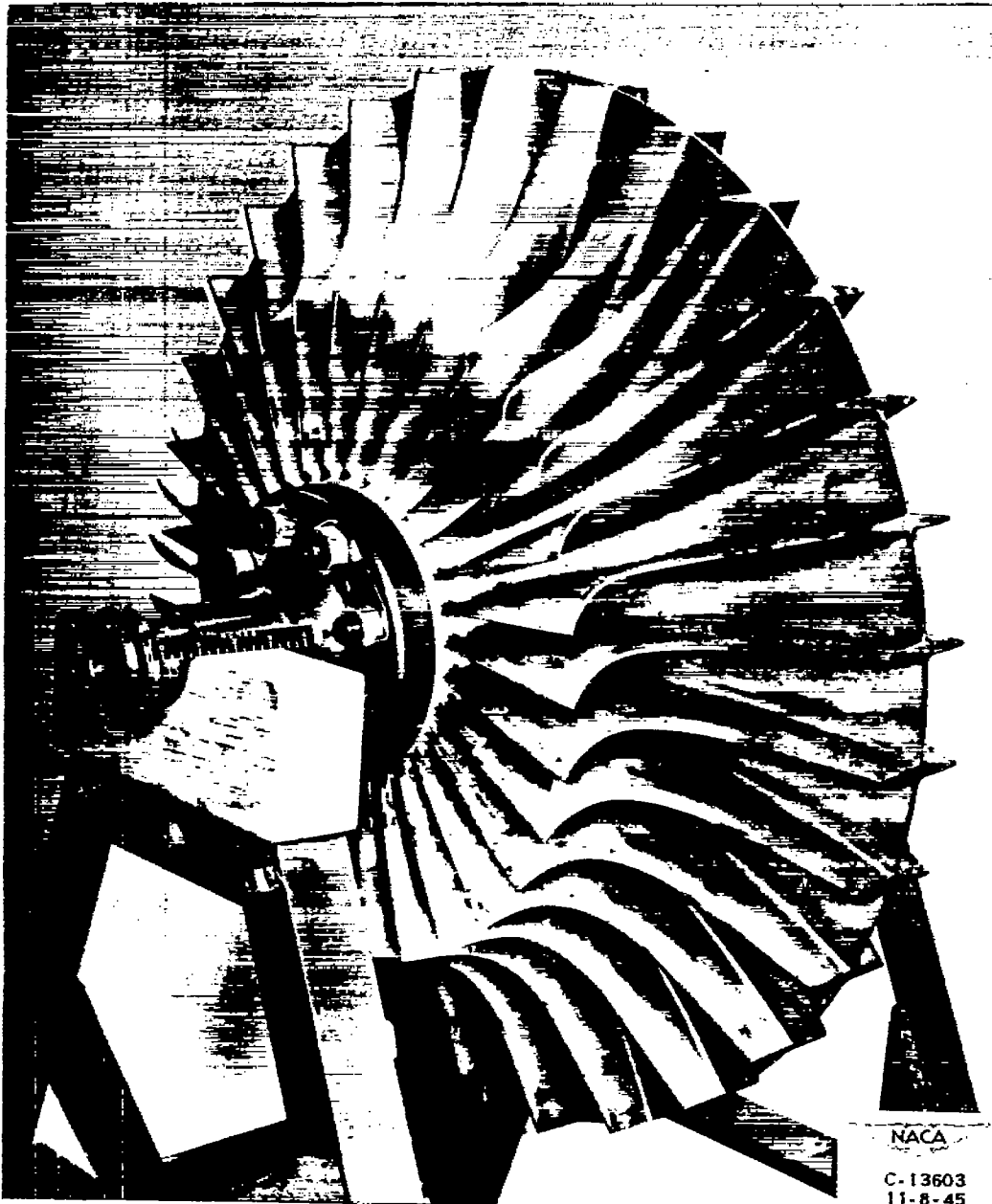

Figure 1. - Centrifugal-compressor impeller of I-40 jet-propulsion engine.

642



- 2 Compressor inlet, front
- 3 Compressor face
- 4 Compressor discharge
- 2 Compressor inlet, rear
- 5 Turbine-nozzle inlet

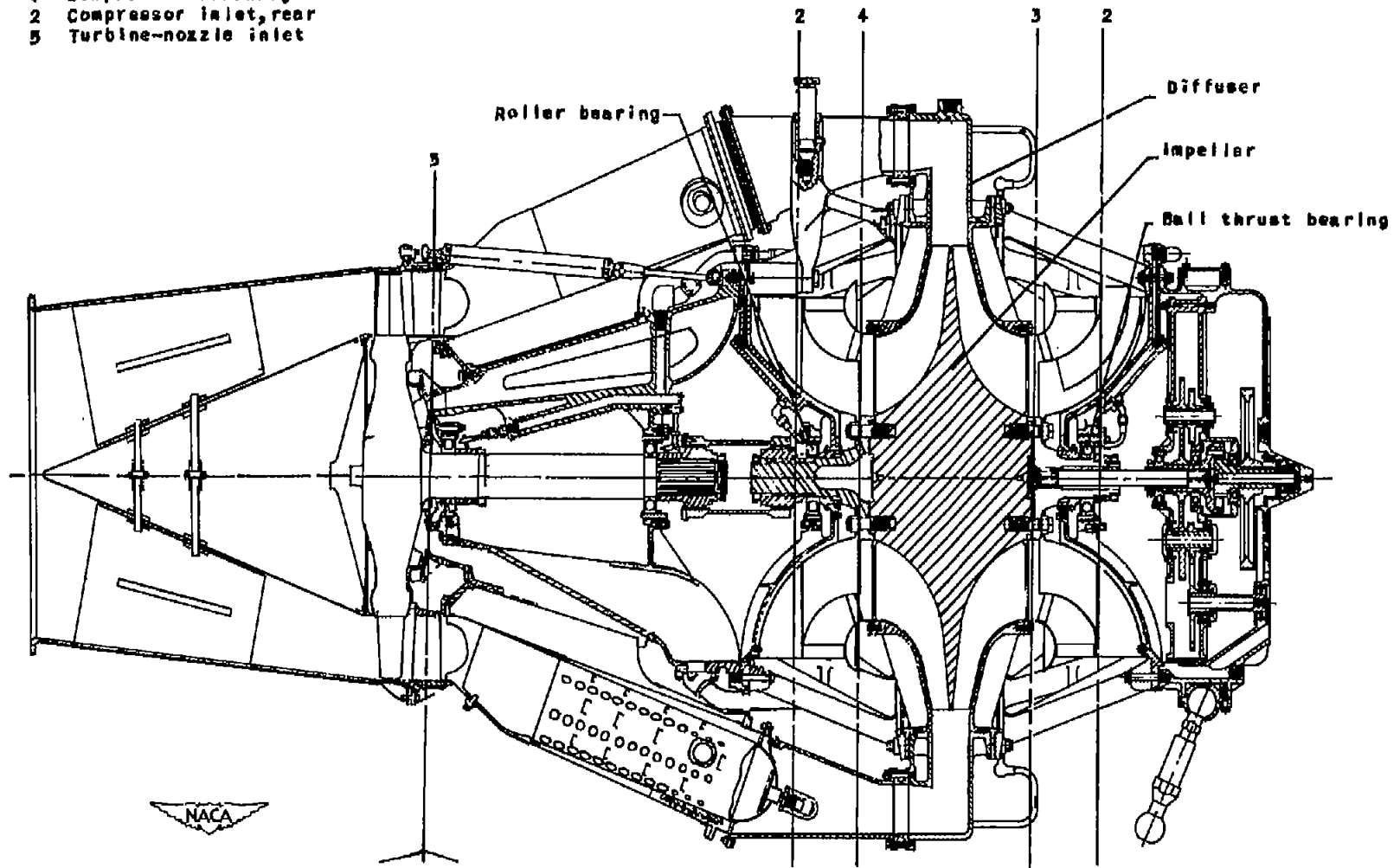

Figure 2. - Cross section of I-40 jet-propulsion engine.



642

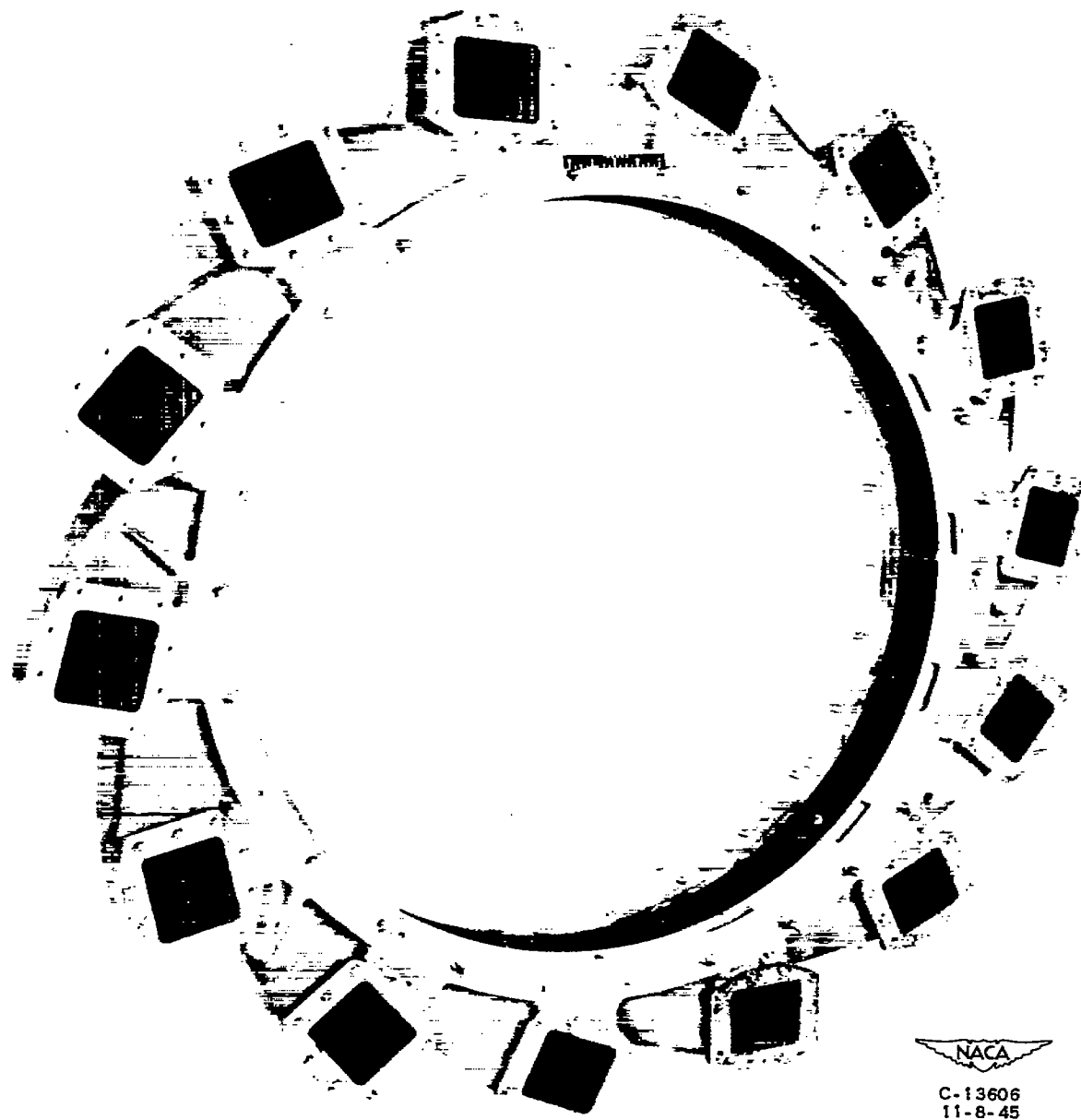
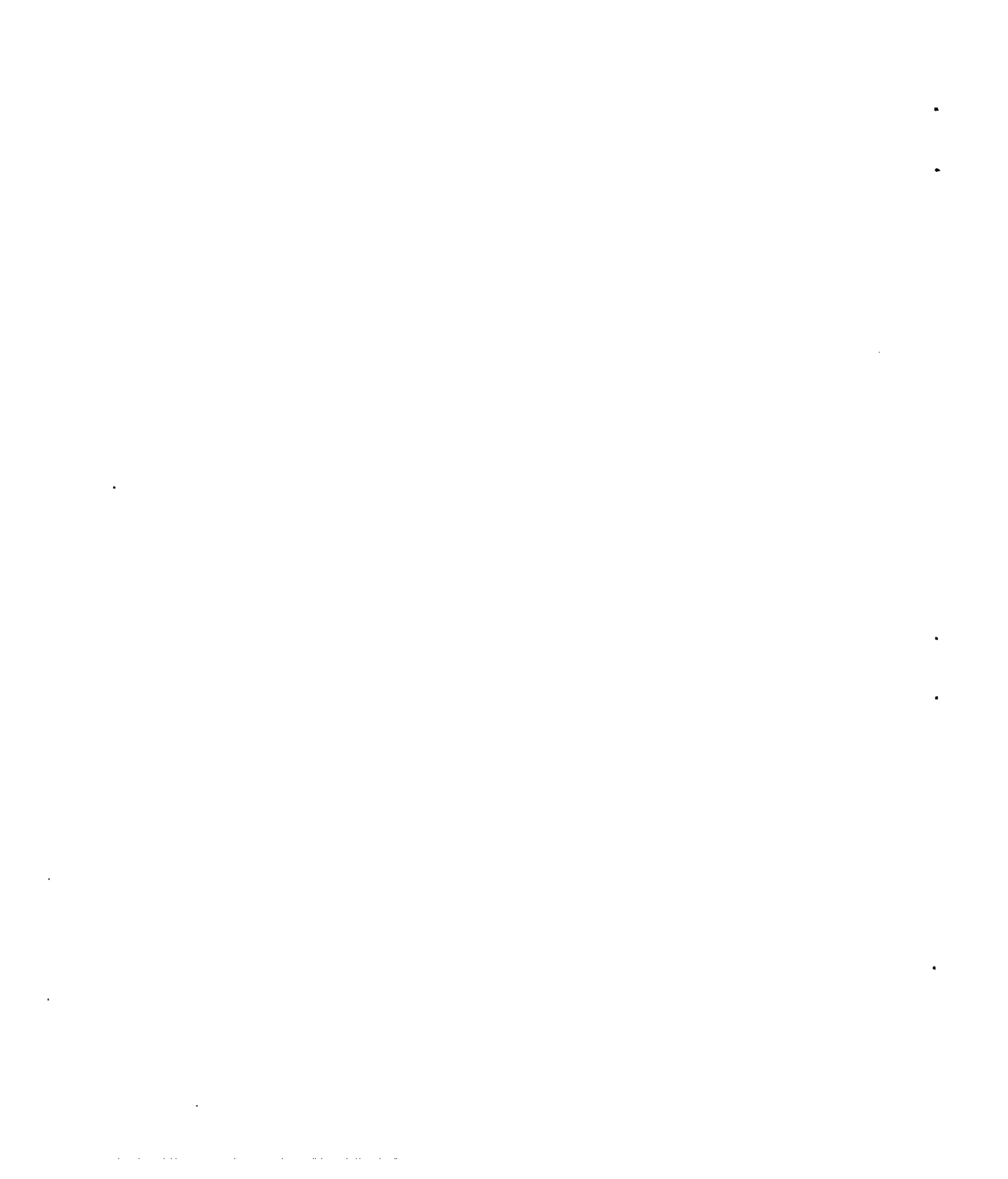

Figure 3. - Diffuser of I-40 jet-propulsion engine showing vanes around periphery and turning vanes in diffuser elbows.



Instrumentation station

- | | |
|---------------------|---------------------------|
| 0 Free stream | 4 Compressor outlet |
| 2 Compressor inlets | 5 Turbine-nozzle inlet |
| 3 Compressor face | 8 Tail-pipe-nozzle outlet |

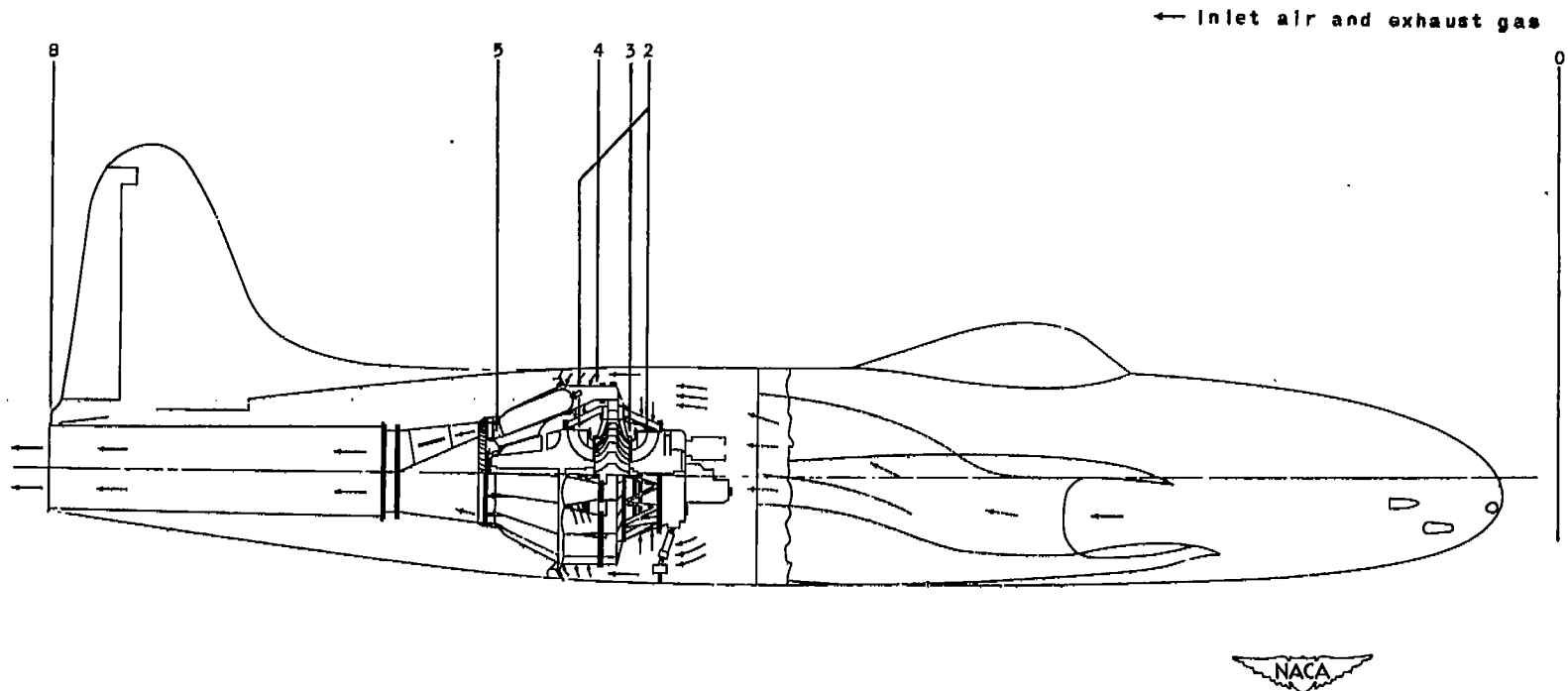

Figure 4. - The I-40 jet-propulsion engine installed in airplane fuselage.

- A Tail-pipe-nozzle outlet static pressure
- B Turbine-nozzle inlet total pressure
- C Turbine-nozzle inlet temperature
- D Compressor-outlet total pressure and temperature survey
- E Compressor-outlet total pressure and temperature survey (INACA)
- F Tail-pipe-nozzle outlet total and static pressure and temperature survey
- G Rear compressor-inlet total pressure
- H Rear compressor-inlet total pressure and temperature
- I Front compressor-face total-pressure survey
- J Front compressor-inlet total pressure and temperature

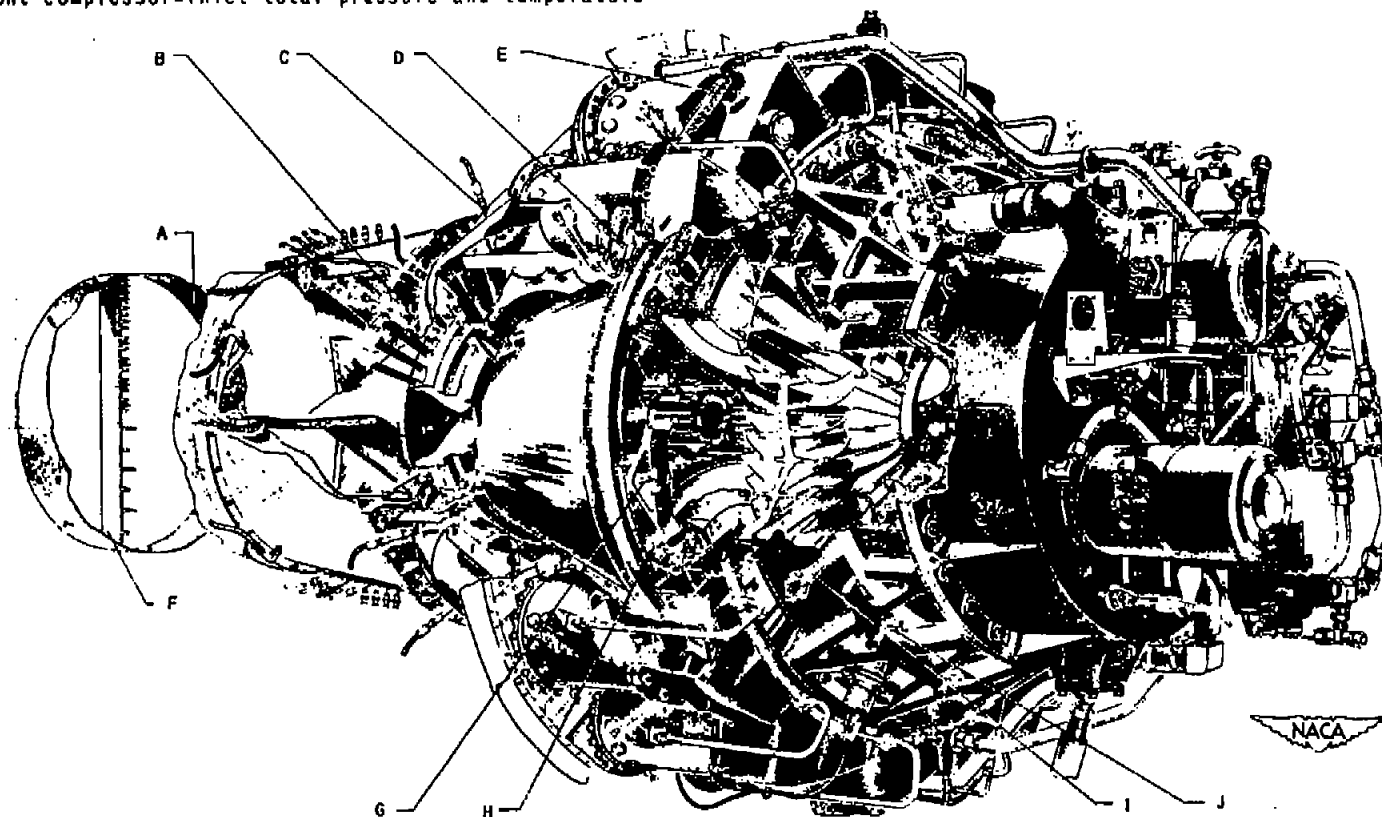
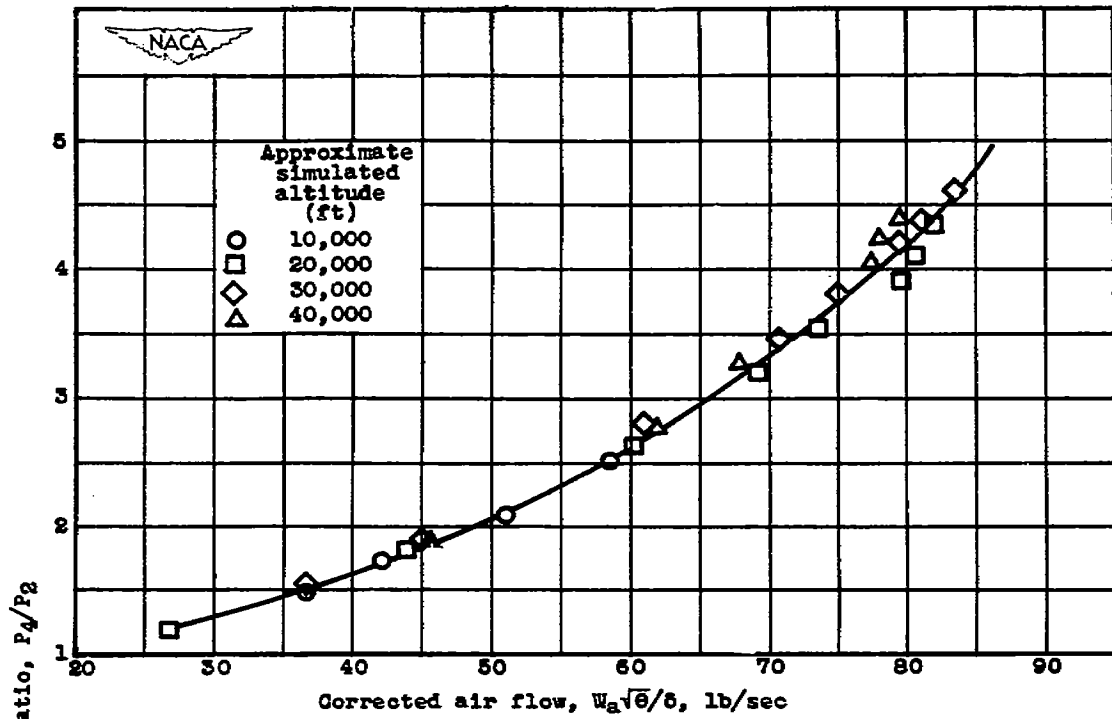
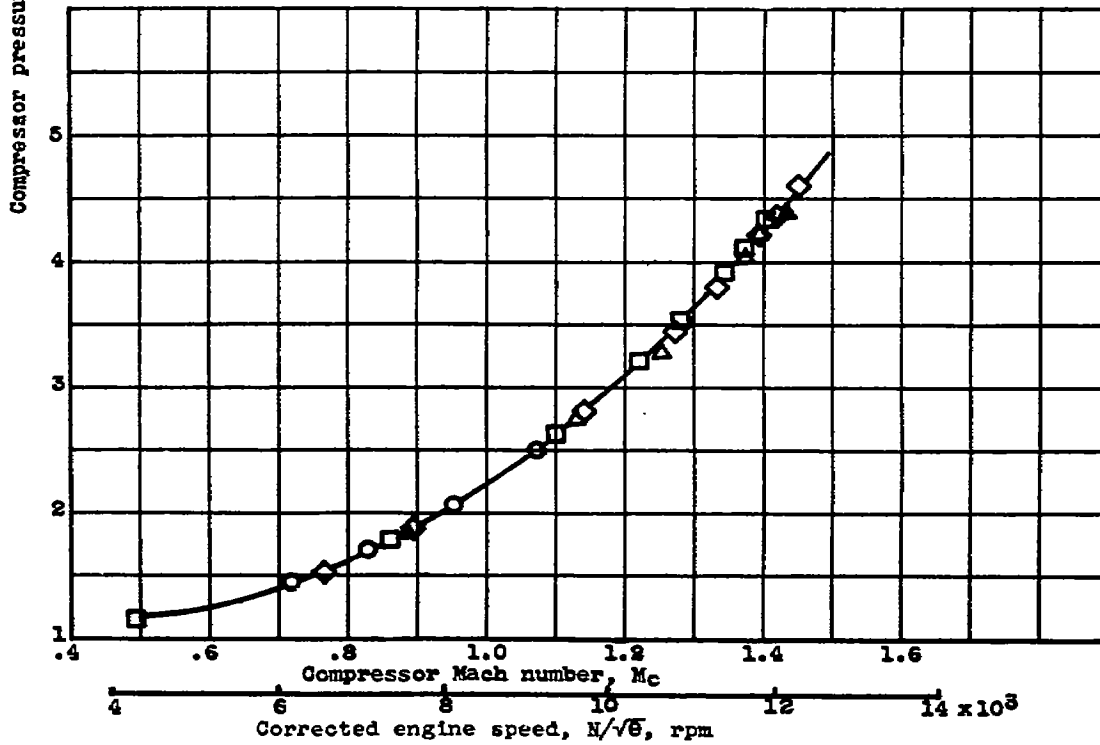

Figure 5. -- Drawing of 1-40 turbojet engine showing location of instrumentation.



(a) Relation between compressor pressure ratio and corrected air flow.



(b) Relation between compressor pressure ratio and compressor Mach number.
 Figure 6.- Effect of altitude on compressor operating line at ram pressure ratio of 1.20.

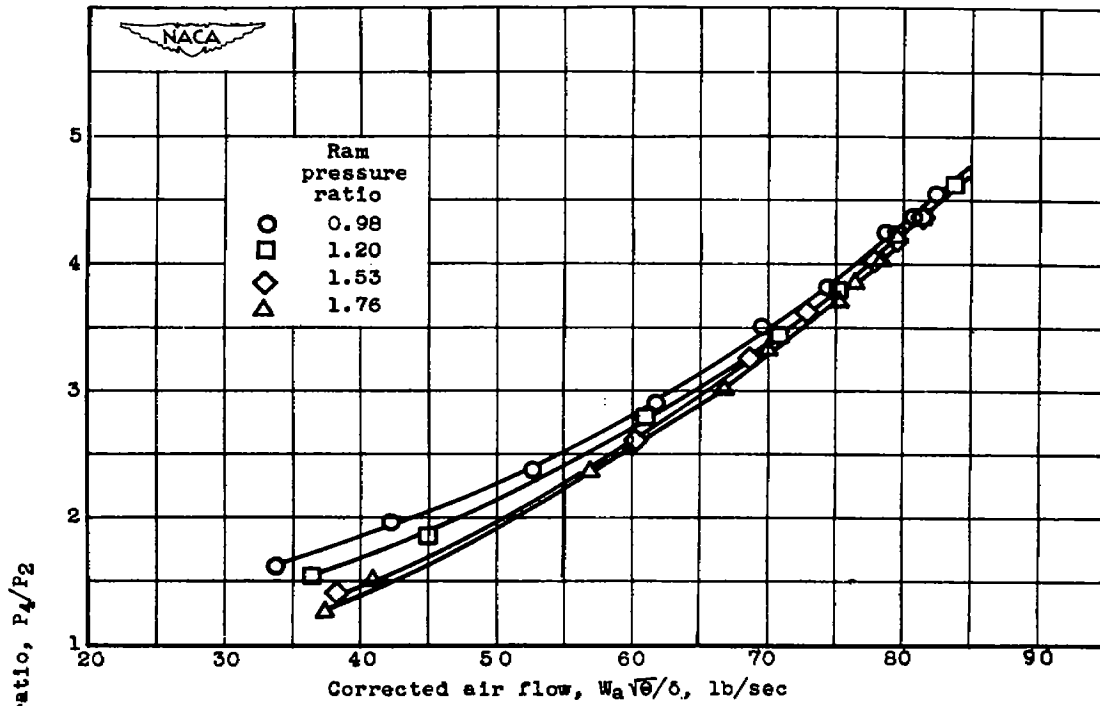

(a) Relation between compressor pressure ratio and corrected air flow.

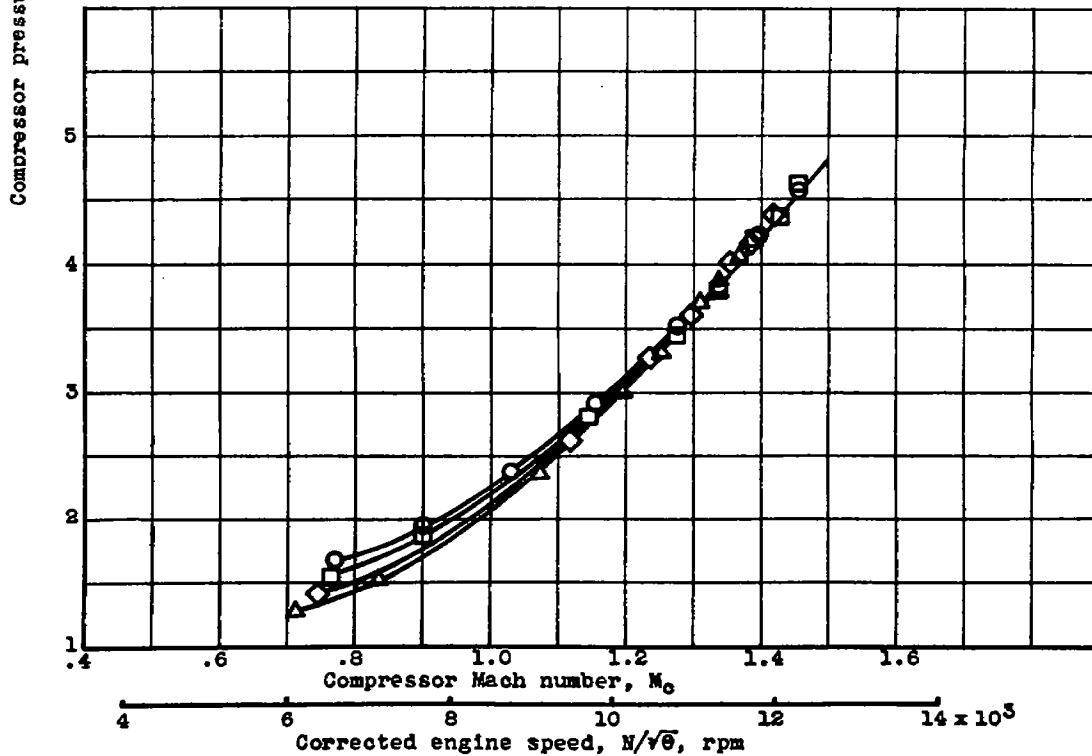
(b) Relation between compressor pressure ratio and compressor Mach number.
Figure 7.- Effect of ram pressure ratio on compressor operating line at simulated altitude of 30,000 feet.

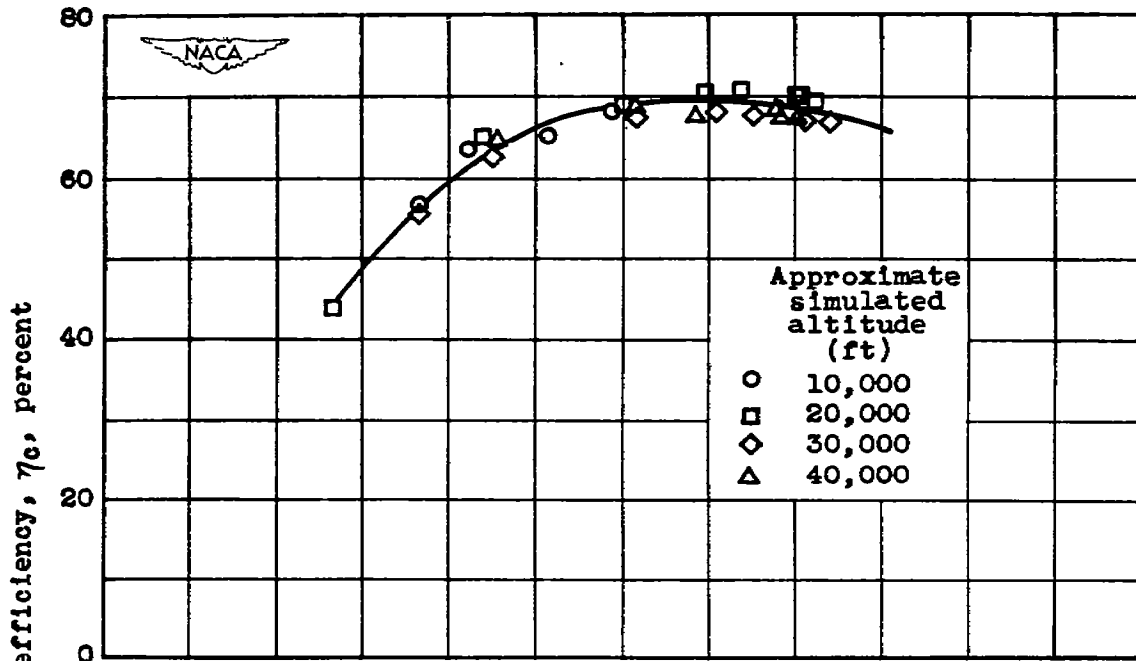

(a) Effect of altitude at ram pressure ratio of 1.20.

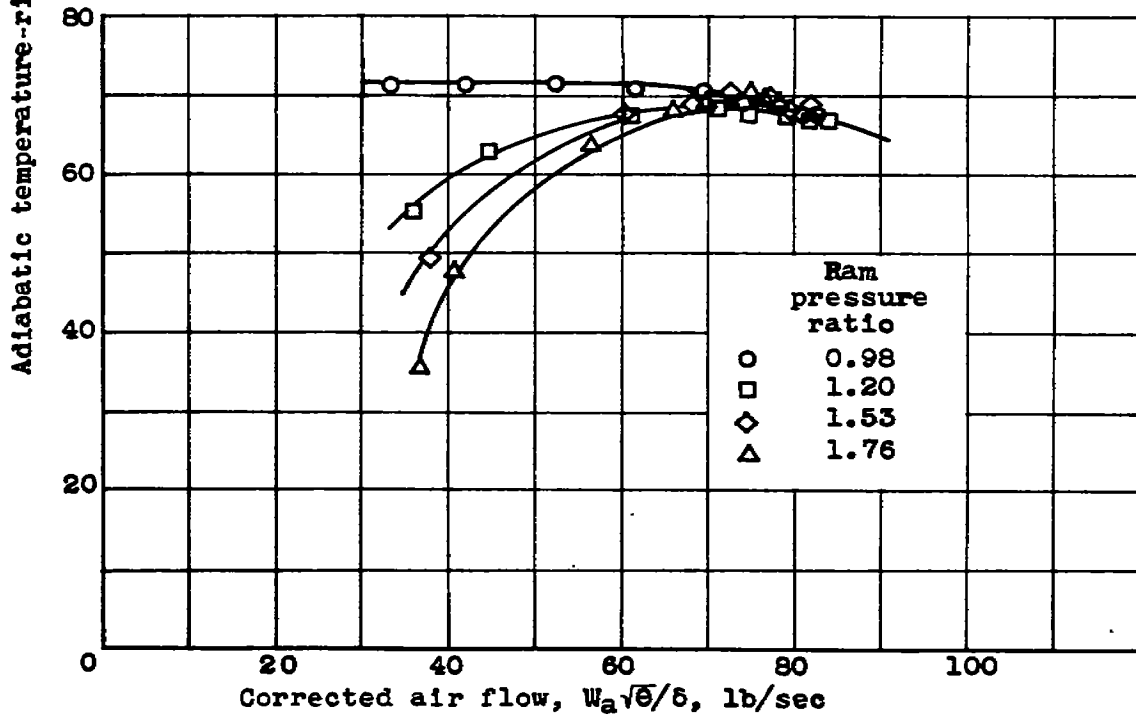

(b) Effect of ram pressure ratio at simulated altitude of 30,000 feet.

Figure 8.- Relation between corrected air flow and compressor efficiency.

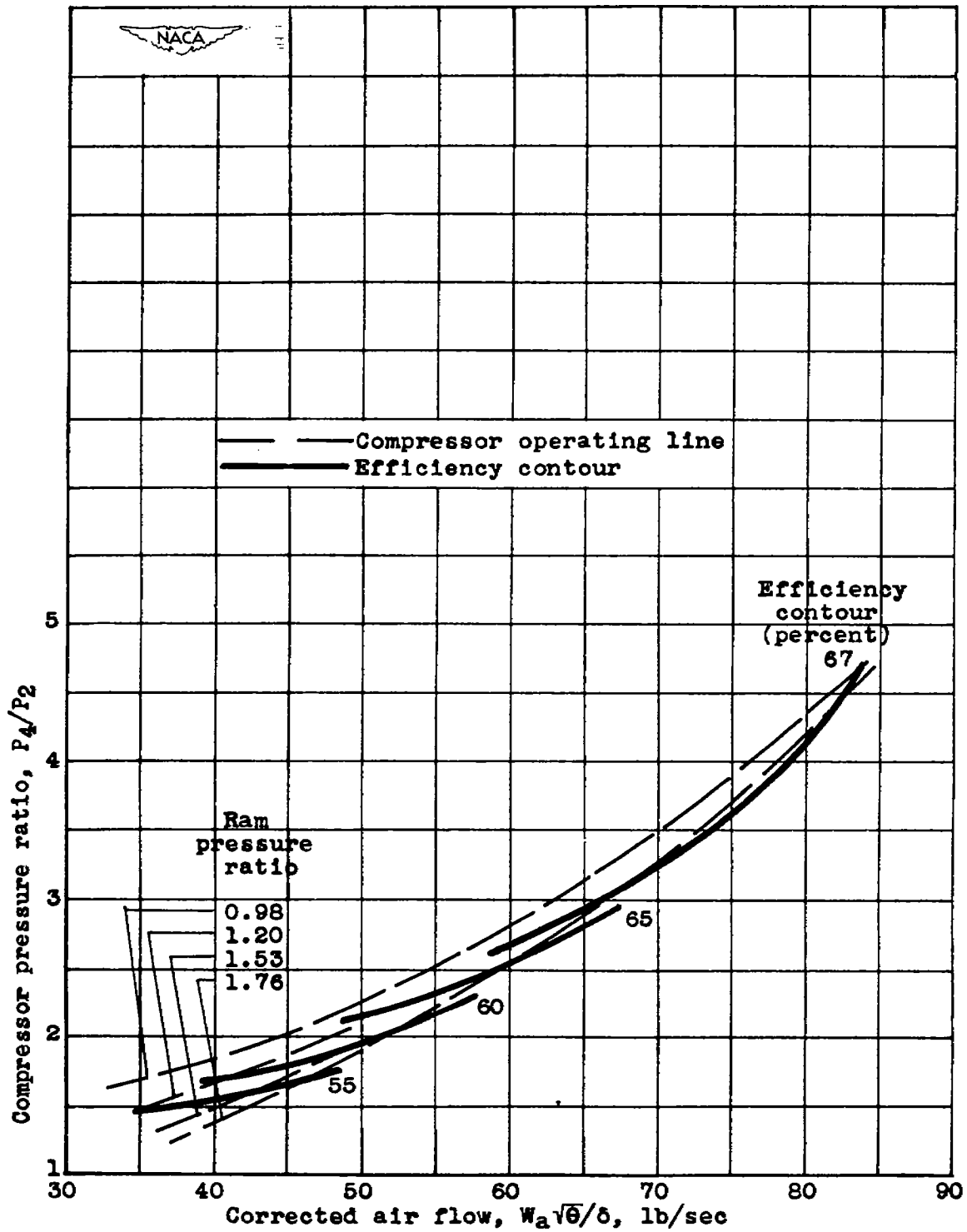
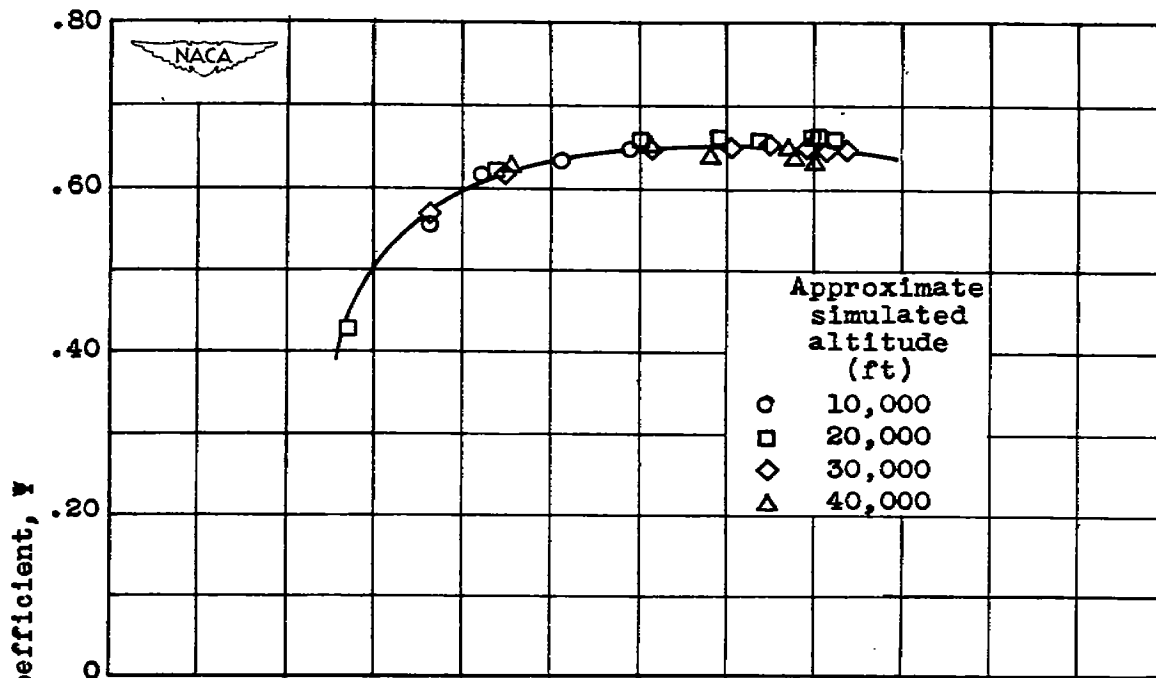
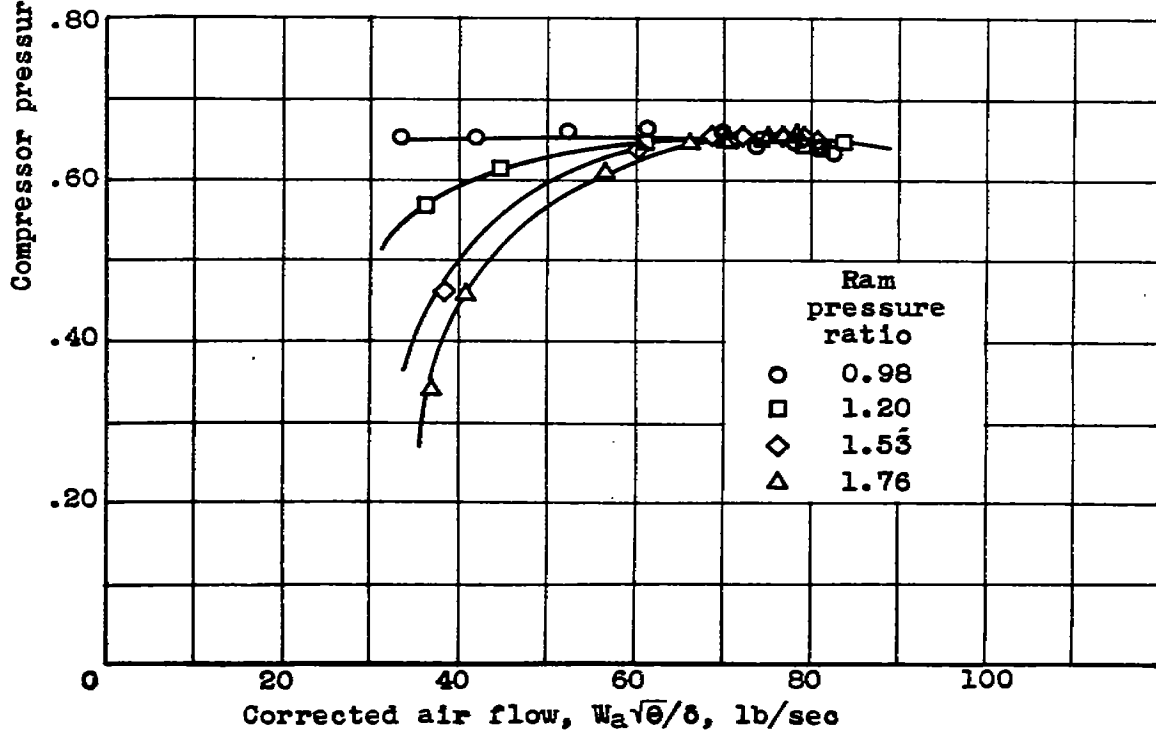

Figure 9.- Adiabatic temperature-rise efficiency characteristics at simulated altitude of 30,000 feet.



(a) Effect of altitude at ram pressure ratio of 1.20.



(b) Effect of ram pressure ratio at simulated altitude of 30,000 feet.

Figure 10.- Compressor pressure coefficient.

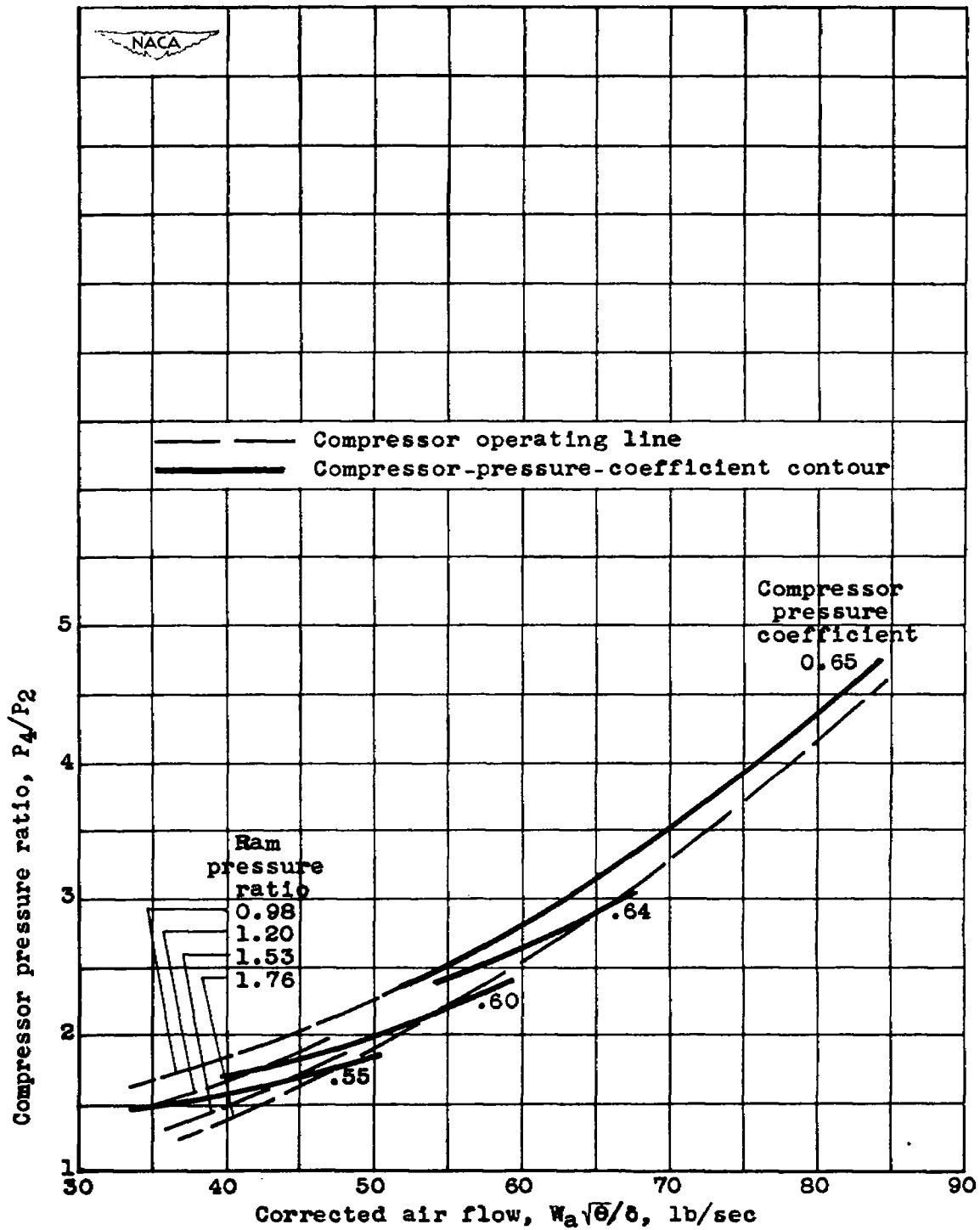

Figure 11.- Pressure coefficient contours at simulated altitude of 30,000 feet.



3 1176 01435 5474