

3 OCT 1947

NATIONAL ADVISORY COMMITTEE
FOR AERONAUTICS

TECHNICAL NOTE

No. 1441

COMPARISON OF THE CONTROL-FORCE CHARACTERISTICS
OF TWO TYPES OF LATERAL-CONTROL
SYSTEM FOR LARGE AIRPLANES

By Owen J. Deters

Langley Memorial Aeronautical Laboratory
Langley Field, Va.



Washington
September 1947

FOR REFERENCE

NOT TO BE TAKEN FROM THIS ROOM

N A C A LIBRARY

LANGLEY MEMORIAL AERONAUTICAL
LABORATORY
Langley Field, Va.



NATIONAL ADVISORY COMMITTEE FOR AERONAUTICS

TECHNICAL NOTE NO. 1441

COMPARISON OF THE CONTROL-FORCE CHARACTERISTICS
OF TWO TYPES OF LATERAL-CONTROL
SYSTEM FOR LARGE AIRPLANES

By Owen J. Deters

SUMMARY

An analysis of wind-tunnel data for two types of lateral-control system for large airplanes was made to determine the control-force characteristics and rolling effectiveness of each system. The two types of lateral-control system are a spring-tab aileron and a combination spoiler and guide or pilot-aileron arrangement. Two configurations of the spring-tab aileron were examined: one with ailerons interconnected and a central spring unit and one with ailerons not interconnected and separate spring units for each aileron. In addition, for the configuration with ailerons interconnected, the geared spring tab as well as the ordinary ungeared spring tab was considered. Similarly, two configurations of the spoiler pilot-aileron control system were considered: one in which the complete spoiler was employed and one in which the outboard segments directly in front of the pilot aileron were removed.

A comparison of the control-force characteristics of the spring-tab control system and the spoiler pilot-aileron control system indicated, in general, that at high speeds the spring-tab aileron would provide slightly greater rolling effectiveness for smaller control forces than would the spoiler system but at low speeds much larger values of rolling effectiveness would be obtained with the spoiler pilot-aileron system than with the spring-tab system for a given value of control force.

When any appreciable upfloating tendency of the ailerons exists, the spring-tab aileron configuration in which the ailerons are interconnected would be the most desirable.

The effect of removing the outboard spoiler segments directly in front of the pilot aileron was to increase the control forces of the spoiler pilot-aileron control system for a given value of

the wing-tip helix angle $pb/2V$ and to reduce the maximum value of $pb/2V$.

INTRODUCTION

With the increase in size and speed of airplanes, the problem of providing adequate control with acceptable control forces has become increasingly difficult, particularly in the case of lateral controls. Two lateral-control systems that have shown promise of providing a satisfactory solution to the problem of lateral control for large airplanes are the spring-tab aileron and the combination spoiler and guide or pilot aileron. The pilot aileron is a short-span aileron located at the wing tip and operated in conjunction with the spoiler. The spring-tab type of control system is well established and has been described in numerous papers (for example, reference 1). The spoiler pilot-aileron control system, a comparatively recent development (reference 2), employs a circular-arc-type spoiler as the main control and a pilot aileron at the wing tip. The pilot aileron is used: (1) to provide a means of correcting any overbalance of the system resulting from spoiler hinge moments, (2) to correct the ineffectiveness of the spoiler at small projections, and (3) to provide means of correcting any lag which may result from the spoilers.

Wind-tunnel data are available (references 3 and 4) for both types of control system from tests of a partial-span wing model of a large bomber-type airplane, and an analysis was made to determine the general control-force characteristics of the two types of control system. Control forces and the corresponding wing-tip helix angles were estimated for a high-speed and low-speed attitude of an assumed airplane. Two configurations of the spring-tab control system were examined: one with ailerons interconnected and a central spring unit and one with ailerons not interconnected and separate spring units for each aileron. In addition, for the configuration with ailerons interconnected, the geared spring-tab as well as the ordinary spring-tab system was considered. Similarly, two configurations of the spoiler pilot-aileron system were considered: one in which the complete spoiler was used and one in which the outboard spoiler segments directly in front of the aileron were removed.

SYMBOLS

C_L	lift coefficient
C_l	rolling-moment coefficient
C_n	yawing-moment coefficient
C_{h_a}	spring-tab aileron hinge-moment coefficient
$C_{h_{ap}}$	pilot-aileron hinge-moment coefficient
C_{h_s}	spoiler hinge-moment coefficient
C_{h_t}	tab hinge-moment coefficient
α	angle of attack, degrees
δ_a	spring-tab aileron deflection, degrees
δ_{ap}	pilot-aileron deflection, degrees
δ_h	aileron-horn deflection (measured from position of horn when control wheel is neutral), degrees
δ_t	tab deflection, degrees
δ_s	spoiler deflection (measured from position of spoiler when upper surface is tangent to wing surface), degrees
δ_w	control-wheel deflection, degrees
θ	angular difference between deflection of aileron and aileron horn, degrees
$pb/2V$	wing-tip helix angle, radians
b	wing span, feet
c	wing chord, feet
c_a	aileron chord behind hinge line, feet
p	rolling velocity, radians per second
V	true airspeed, feet per second

V_i	indicated airspeed, miles per hour
q	dynamic pressure, pounds per square foot
F_a	aileron control force, pounds
F_{sap}	spoiler pilot-aileron control force, pounds
K	spring-unit constant, pound-feet per degree θ
P	spring-unit preload, pound-feet
H_a	spring-tab aileron hinge moment (positive when tending to produce a positive aileron deflection), pound-feet
H_{ap}	pilot-aileron hinge moment (positive when tending to produce a positive aileron deflection), pound-feet
H_s	spoiler hinge moment (positive when tending to produce a positive spoiler deflection), pound-feet
H_t	tab hinge moment (positive when tending to produce a positive tab deflection), pound-feet
l, m, n	dimensions of spring-tab system shown in figure 2

ASSUMED AIRPLANE AND FLIGHT CONDITIONS

Characteristics of Airplane

The wind-tunnel data were obtained from tests of a partial-span wing model of a large bomber-type airplane. The general dimensions of the airplane wing are shown in figure 1. The midchord wing slots shown in figure 1 for the spring-tab aileron control system are open only when the flaps are deflected. Additional data for the airplane not included in figure 1 are as follows:

Gross weight, pounds	265,000
Wing area, square feet	4772
Wing loading, pounds per square foot	55.5
Aspect ratio	11.1
Taper ratio	0.25
Control-wheel diameter, inches	14
Ratio of m to n (fig. 2)	2.5
Ratio of l to m for the geared tab (fig. 2)	2/3

Geometric Characteristics of the Two
Lateral-Control Systems

Spring-tab control system.- In the analysis of the spring-tab aileron control system both the geared and ungeared, or ordinary, spring-tab systems were considered. The geared spring tab is shown in the schematic diagram of figure 2. A geared spring tab will deflect as the control wheel is deflected although there is no load on the system, but the ordinary spring tab will not deflect when no load is on the system. It is evident from figure 2 that the ordinary spring-tab system is a special case of the geared spring-tab system. When the dimensions l and m are equal, the system has no gearing; when $l > m$, the tab is geared in the conventional manner; and when $l < m$, the tab will lead the aileron. When the spring constant is zero, the system becomes a pure servocontrol and no gearing is possible.

Two principal configurations of the spring-tab control system were also considered: one with ailerons interconnected and a central spring unit (fig. 2(a)) and one with ailerons not interconnected and separate spring units for each aileron (fig. 2(b)).

The tab deflection is a function of θ , the angular difference between the aileron and aileron-horn deflections, and, for small values of θ , is closely approximated by the relationship

$$\delta_t = \frac{m}{n}\theta$$

The maximum tab deflection was limited to $\pm 20^\circ$. Although this value may be slightly large, the test data did not indicate any tendency for the tab to stall at $\pm 20^\circ$ deflections.

The spring-unit constant K is defined in terms of θ . By so defining K the control forces depend only on the ratios m/n and l/m .

The mechanical advantage of the system was held constant for all configurations and is defined as the rate of change of aileron-horn deflection with control-wheel deflection. The mechanical advantage employed in the estimation of the control forces was

$$\frac{d\delta_h}{d\delta_c} = 0.20.$$

Spoiler pilot-aileron control system.- The spoiler pilot-aileron control system is a direct control system in which the spoiler and pilot aileron are linked directly to the control wheel. The ailerons operate in the conventional manner but the spoiler remains in a neutral position with the positively deflected aileron.

Two configurations of the spoiler are considered. In the first configuration the complete spoiler is used as shown in figure 1, whereas in the second configuration the two outboard spoiler segments directly in front of the aileron are removed. The operation of the pilot aileron in the wake of the spoiler could cause serious buffeting of the aileron; therefore, the effect of removing the segments directly in front of the pilot aileron on the characteristics of the system is determined.

The spoiler control forces were estimated for two rates of deflection of the pilot aileron. In one arrangement the pilot-aileron deflection varies linearly with the control-wheel deflection, and in the second arrangement the pilot-aileron deflection varies nonlinearly as shown in figure 3.

In the estimation of the control forces of the spoiler pilot-aileron control system the maximum control-wheel deflection was $\pm 135^\circ$, and the maximum spoiler and pilot-aileron deflections were -60° and $\pm 20^\circ$, respectively.

The vent behind the spoiler (fig. 1) consists of a small duct (0.01c) extending between the upper and lower surfaces of the wing and is fixed in an open condition in the wing. It is shown in reference 4 that an increase in rolling effectiveness can be gained if the vent is not fixed in an open condition but remains closed until the spoiler begins to deflect and then opens completely. The control forces and helix angles were estimated for an arrangement in which the vent was assumed to open instantaneously as the spoiler began to deflect. Although the vent would not open instantaneously in a practical installation, the rate at which it opened would not affect the wing-tip helix angle.

Flight Conditions

The control forces and the corresponding wing-tip helix angles are determined at two flight attitudes, that is, high-speed and landing attitudes. The high-speed attitude is the same for both the spring-tab aileron and the spoiler pilot-aileron control systems. The assumed conditions are $C_L = 0.555$, $\alpha = 3.5^\circ$,

and $V_1 = 198$ miles per hour, which corresponds to a dynamic pressure of 100 pounds per square foot.

Inasmuch as partial-span single slotted flaps were employed with the spring-tab aileron control system and full-span double slotted flaps were employed with the spoiler pilot-aileron control system, the maximum lift coefficient in each case was considerably different. The low-speed attitude was chosen as 110 percent of minimum speed, and as a result of the difference in maximum lift coefficient for the two systems the low-speed conditions are slightly different for the two control systems. The assumed low-speed conditions for the spring-tab aileron control system are $C_L = 1.85$, $\alpha = 14.0^\circ$, and $V_1 = 108$ miles per hour, which corresponds to a dynamic pressure of 30 pounds per square foot. The assumed low-speed conditions for the spoiler pilot-aileron control system are $C_L = 2.16$, $\alpha = 11.0^\circ$, and $V_1 = 100$ miles per hour, which corresponds to a dynamic pressure of 25.7 pounds per square foot.

ESTIMATION OF CONTROL FORCES AND WING-TIP HELIX ANGLE

Representative plots of the wind-tunnel data from which the control forces and wing-tip helix angles were estimated are shown in figure 4 for the spring-tab aileron and in figure 5 for the spoiler pilot-aileron control system. The aileron, tab, and spoiler hinge moments are obtained from the hinge-moment coefficients by the following equations: For the spring-tab aileron,

$$H_a = 352qC_{h_a}$$

for the tab,

$$H_t = 7.18qC_{h_t}$$

for the pilot aileron,

$$H_{a_p} = 66.15qC_{h_{a_p}}$$

and for the spoiler,

$$H_s = 2.47qC_{h_s}$$

The rolling and yawing moments are obtained from the rolling-moment and yawing-moment coefficients by the conventional relationships.

The spring-tab aileron control forces and the corresponding values of the wing-tip helix angle $pb/2V$ were determined by the methods of reference 5. The control forces and the wing-tip helix angles for the spoiler pilot-aileron control system were determined by a method analogous to that described in reference 6. Although the corrections to the spoiler hinge moments for the effect of the rolling motion of the airplane were determined by the methods developed for conventional ailerons (reference 6), the errors resulting from the use of this method were negligible inasmuch as the variation of the spoiler rolling-moment and hinge-moment coefficients with angle of attack was small for the conditions of this analysis.

The values of the helix angle $pb/2V$ for both the spring-tab and spoiler pilot-aileron control systems were reduced 20 percent to account for the effects of yaw and yawing motion at low speeds and wing twist and compressibility at high speeds. Experience has shown that the empirical reduction of the helix angle by 20 percent is justified for aileron controls. A 20-percent reduction in the helix angle for spoiler controls might be considered too great since the static yawing moment of the spoilers would be favorable (of the same sign as the rolling moment) and would tend to reduce the loss in rolling effectiveness caused by the dihedral effect. Although the static yawing moment is generally favorable, it is relatively small at high angles of attack, particularly when full-span flaps are deflected. The yawing moment due to the rolling motion of the airplane, however, is adverse (tending to reduce the helix angle $pb/2V$) and has a considerably larger effect on the helix angle than does the static yawing moment resulting from the spoiler. Inasmuch as the yawing moment due to the airplane rolling motion is greater for full-span flaps than for the partial-span flap configurations usually employed with ailerons, it is believed that this increase in yawing moment would counteract the favorable static yawing moment of the spoilers and that the empirical reduction of the helix angle by 20 percent is justified for spoiler controls. At the high-speed attitude the helix angle may be slightly underestimated since the twisting moment caused by spoiler controls is usually smaller than that caused by aileron controls.

CONTROL-FORCE CHARACTERISTICS OF THE TWOLATERAL-CONTROL SYSTEMSSpring-Tab Control System

The control-force characteristics of the spring-tab aileron are shown in figure 6 for the configuration in which the ailerons are interconnected and in figure 7 for the case in which the ailerons are not interconnected.

Ailerons interconnected.— At low speeds (fig. 6(a)) the control forces were greatly reduced as the magnitude of the spring-unit constant was decreased from ∞ to 0. As the spring-unit constant is reduced, however, the maximum tab deflection is reached at a smaller deflection of the ailerons, and thus the maximum value of the helix angle attained with the spring tab in operation is reduced.

At high speeds (fig. 6(b)) the ailerons were slightly overbalanced as shown by the hinge-moment characteristics of figure 4(a). The use of the spring tab greatly reduced the amount of overbalance; the use of a geared spring tab (the tab geared to lead the aileron) completely corrected the overbalance. The tab gearing had the disadvantage, however, of increasing the control forces in the low-speed attitude over those of the ordinary spring-tab configuration. Suitable adjustments in the amount of tab gearing and the spring-unit constant could be used to correct balance without greatly increasing the control forces at low speeds over the values obtained for the ungeared spring tab.

Ailerons not interconnected.— When no interconnection is provided between the ailerons, the spring units must be preloaded to prevent the ailerons from floating up at low speeds. The control forces presented in figure 7 were estimated for the case in which sufficient preload was employed to prevent any upfloating of the ailerons in normal flight attitudes. The constant of each spring unit was chosen to be one-half the value for the central spring unit of the interconnected-aileron configuration (25 lb-ft per deg θ).

As a result of the large amount of preload, the control forces are not effectively reduced in either the high-speed or low-speed attitudes. Allowing the ailerons to float up a limited amount would make the spring tab considerably more effective in reducing the control forces. The minimum amount of preload which could be

employed would be that amount sufficient to prevent the ailerons from floating in either direction at high speeds. The preload would, however, still be too large to permit an effective reduction in the control forces by the spring-tab.

In consideration of the smaller control forces obtained when the ailerons are interconnected and also of the disadvantages of allowing the ailerons to float up when not interconnected, the configuration in which the ailerons are interconnected would be the most desirable spring-tab control arrangement. Further advantages could be gained by employing a differential linkage for both configurations. By means of a differential linkage the control forces might be reduced and the maximum helix angle increased. The extent to which the control characteristics can be improved by use of the differential linkage is dependent upon the particular characteristics of the control system.

Spoiler Pilot-Aileron Control System

The control-force characteristics of both configurations of the spoiler pilot-aileron control system are shown in figure 8 for the low-speed attitude and in figure 9 for the high-speed attitude.

Complete-spoiler configuration.— The spoiler pilot-aileron control system employing the complete spoiler is overbalanced in both the high-speed and low-speed attitudes (figs. 8(a) and 9(a)). The overbalanced control forces of the system are the result of the spoiler hinge-moment coefficients which were overbalanced through a large range of spoiler deflection.

By the use of a nonlinear aileron deflection (fig. 3) the overbalance of the system was greatly reduced but not completely corrected. The instantaneous operation of the vent behind the spoiler caused an increase in the maximum value of $pb/2V$ of about 3 percent at low speeds and about 8 percent at high speeds. At high speeds the control forces of the complete spoiler configuration were very large for the higher values of $pb/2V$. The maximum values of $pb/2V$ were relatively small although at low speeds large values of $pb/2V$ were obtained for small control forces.

Comparing the control-force characteristics of the spoiler pilot-aileron control system with those of the spring-tab control system indicates, in general, that at high speeds the spring-tab aileron will provide slightly greater rolling effectiveness for smaller control forces than the spoiler system. In the low-speed

attitude, however, much larger values of rolling effectiveness were obtained with the spoiler pilot-aileron system than with the spring-tab system for a given control force.

Partial-spoiler configuration.- By the removal of the outboard segments of the spoiler (figs. 8(b) and 9(b)) the overbalance of the system was corrected in the high-speed attitude and was greatly reduced at low speeds. The nonlinear deflection of the aileron completely corrected the overbalance at low speeds but greatly increased the control forces for small control-wheel deflections in the high-speed attitude. The maximum value of $pb/2V$ was decreased about 15 percent as a result of removing the outboard spoiler segments. In general, the effect of removing the outboard spoiler segments was to increase the control force at a given value of the wing-tip helix angle and to reduce the maximum value of $pb/2V$. The increase in control force when the outboard segments of the spoiler were removed is a result of an increase in the total aileron hinge moment. The spoiler segments directly in front of the aileron have a balancing effect on the hinge moment of the upgoing aileron (the hinge moments become more negative). Thus, removing the outboard spoiler segments causes the up aileron hinge moment to become more positive and therefore produces an increase in the total aileron hinge moment and, consequently, in the control force.

CONCLUDING REMARKS

An analysis of wind-tunnel data for a spring-tab aileron and a spoiler pilot-aileron control system was made to determine the control-force characteristics and rolling effectiveness of each system.

A comparison of the control-force characteristics of the spring-tab control system and the spoiler pilot-aileron control system indicated, in general, that at high speeds the spring-tab aileron would provide slightly greater rolling effectiveness for smaller control forces than would the spoiler system but at low speeds much larger values of rolling effectiveness would be obtained with the spoiler pilot-aileron system than with the spring-tab system for a given value of control force.

When any appreciable upfloating tendency of the ailerons exists, the spring-tab aileron configuration in which the ailerons are interconnected would be the most desirable.

The effect of removing the outboard spoiler segments directly in front of the pilot-aileron was to increase the control forces of the spoiler pilot-aileron control system for a given value of the wing-tip helix angle $pb/2V$ and to reduce the maximum value of $pb/2V$.

Langley Memorial Aeronautical Laboratory
National Advisory Committee for Aeronautics
Langley Field, Va., July 17, 1947

REFERENCES

1. Brown, W. S.: Spring Tab Controls. R. & M. No. 1979, British A.R.C., 1941.
2. Ashkenas, I. L.: The Development of a Lateral-Control System for Use with Large-Span Flaps. NACA TN No. 1015, 1946.
3. Deters, Owen J., and Russell, Robert T.: Investigation of the Aileron and Tab of a Spring-Tab Lateral Control System in the Langley 19-Foot Pressure Tunnel. NACA TN No. 1431, 1947.
4. Deters, Owen J., and Russell, Robert T.: Investigation of a Spoiler-Type Lateral Control System with Full-Span Flaps in the Langley 19-Foot Pressure Tunnel. NACA TN No. 1409, 1947.
5. Deters, Owen J.: Estimation of Control Forces of Spring-Tab Ailerons from Wind-Tunnel Data. NACA TN No. 1333, 1947.
6. Swanson, Robert S., and Priddy, E. LaVerne: Lifting-Surface-Theory Values of the Damping in Roll and of the Parameter Used in Estimating Aileron Stick Forces. NACA ARR No. L5F23, 1945.

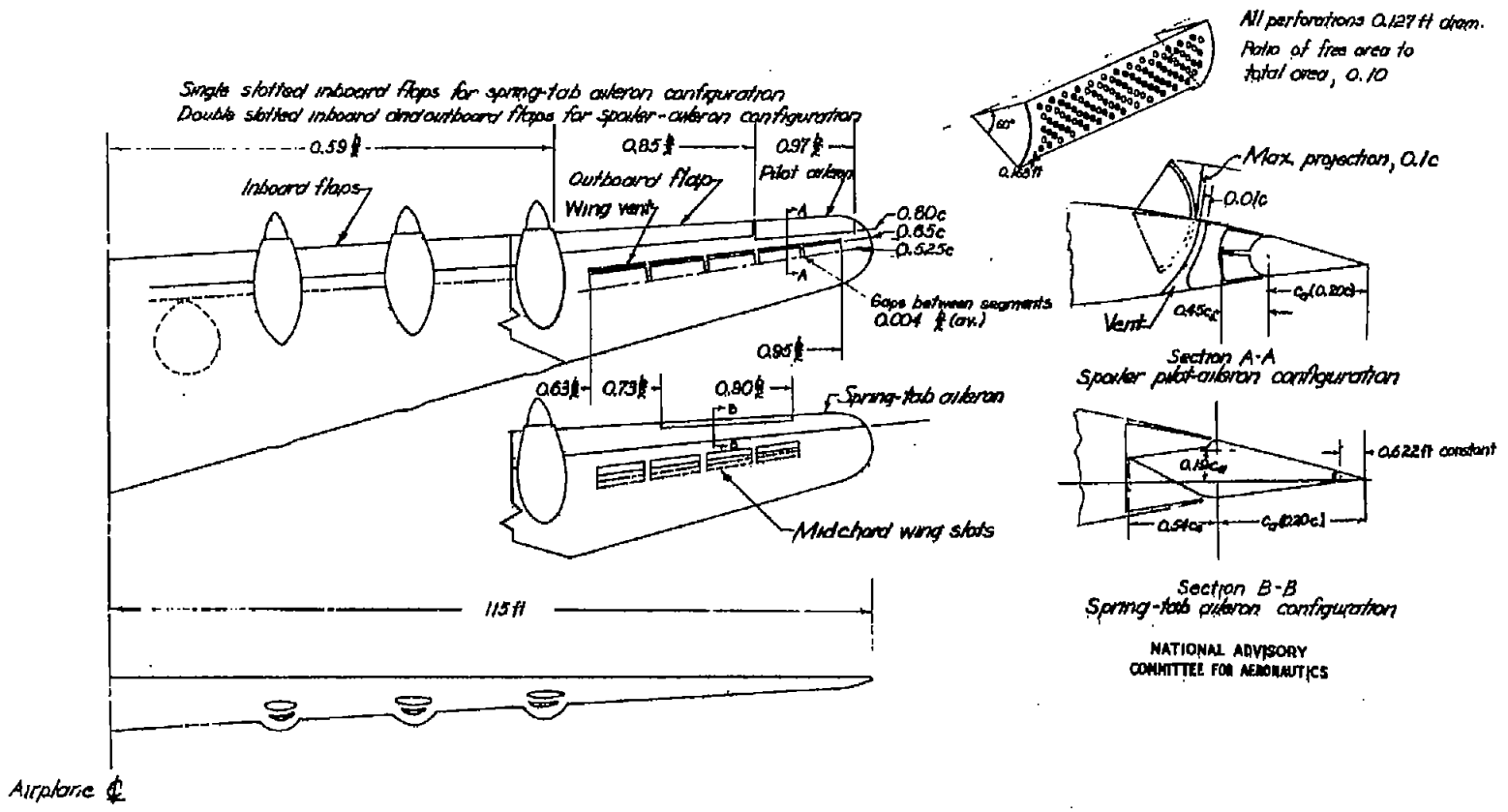
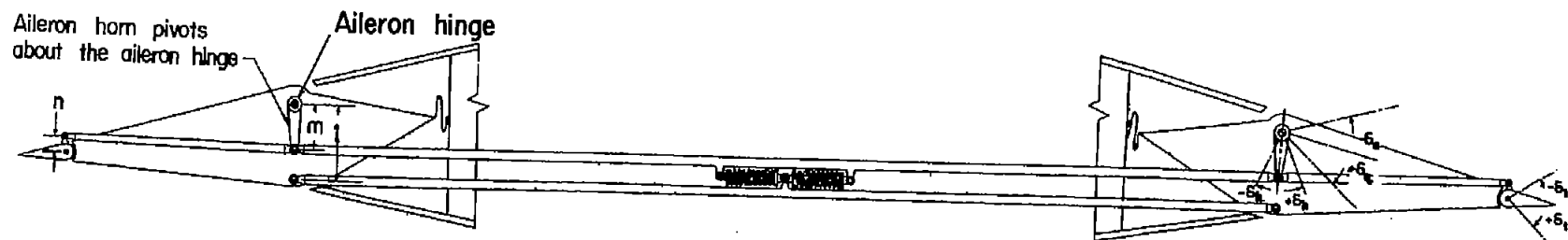
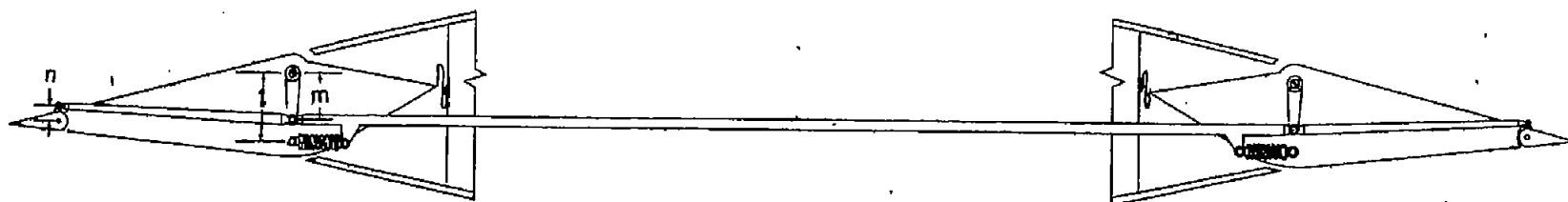

Figure 1.- Geometric characteristics of the wing and lateral-control systems.



(a) Ailerons interconnected, central spring unit.



(b) Ailerons not interconnected, separate spring units.

NATIONAL ADVISORY
COMMITTEE FOR AERONAUTICS

Figure 2 :-Schematic diagram of the two principal configurations of aileron spring-tab systems.

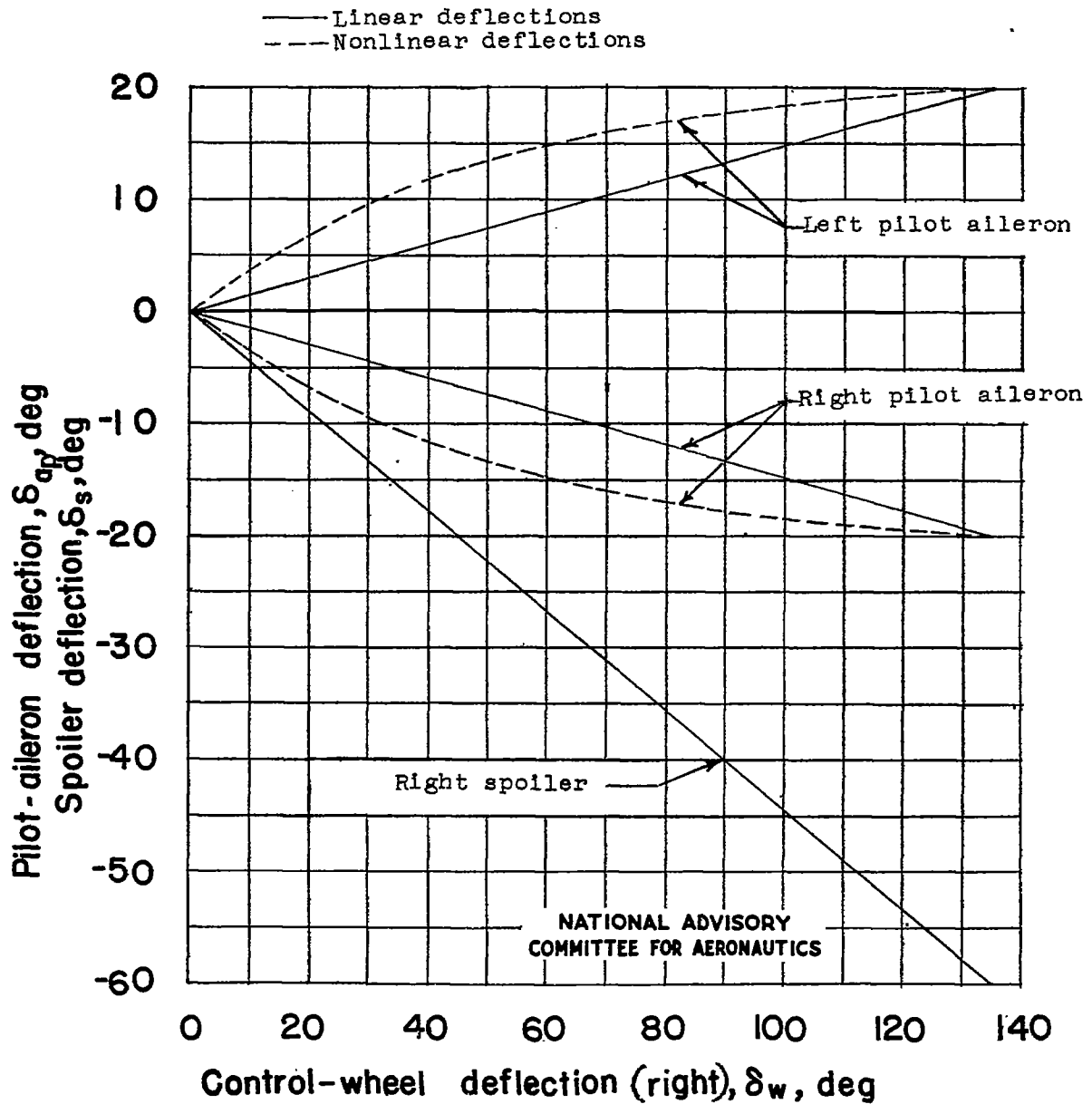

Figure 3.- The variation of spoiler and pilot-aileron deflection with control-wheel deflection assumed for the computation of spoiler control forces.

(a) $\alpha = 3.5^\circ$; flaps neutral.

Figure 4.- Representative data of the characteristics of the aileron and spring tab from which the control-force characteristics were estimated.



(b) $\alpha = 14.0^\circ$; partial-span single slotted flaps deflected 40° .

Figure 4.- Concluded.

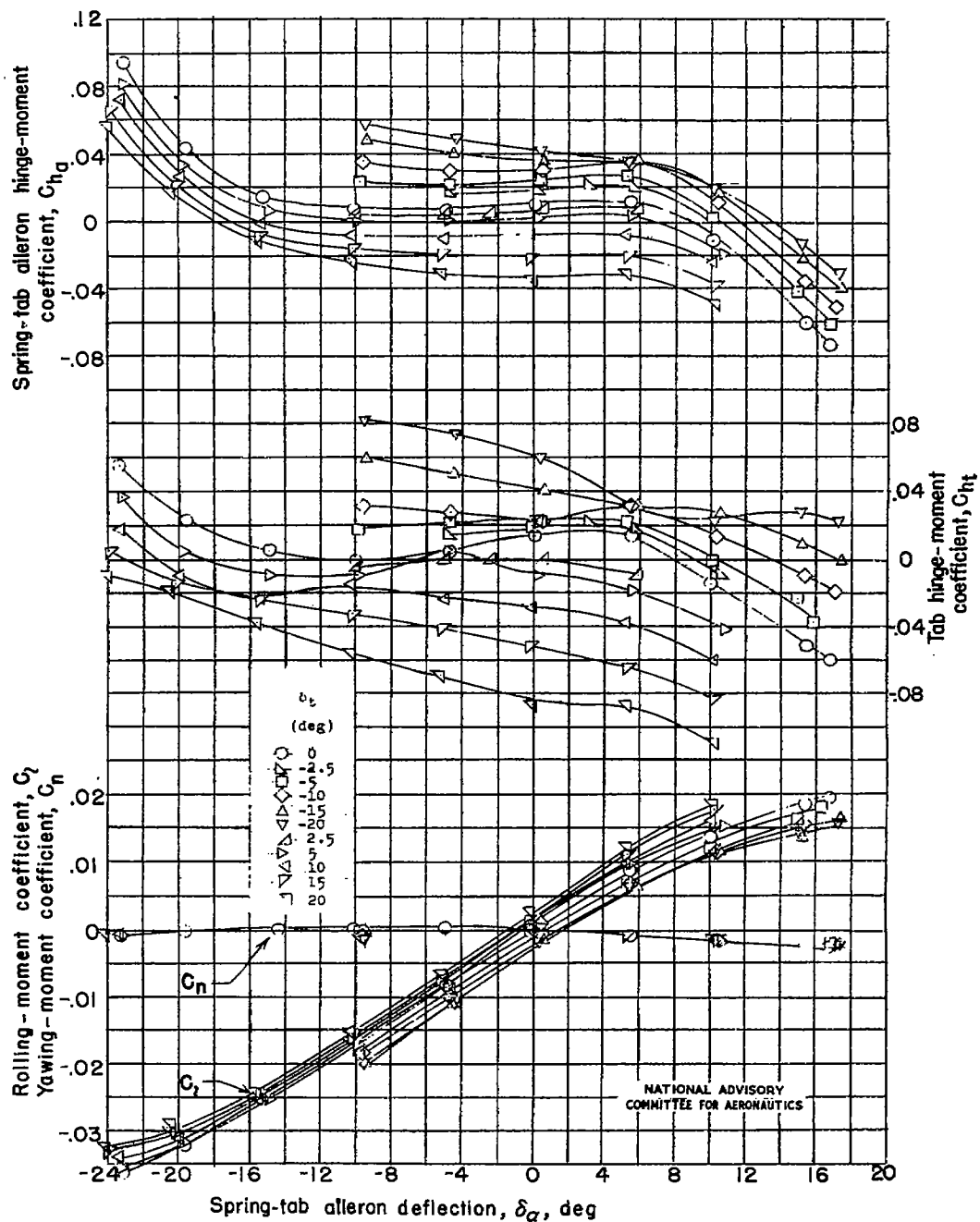
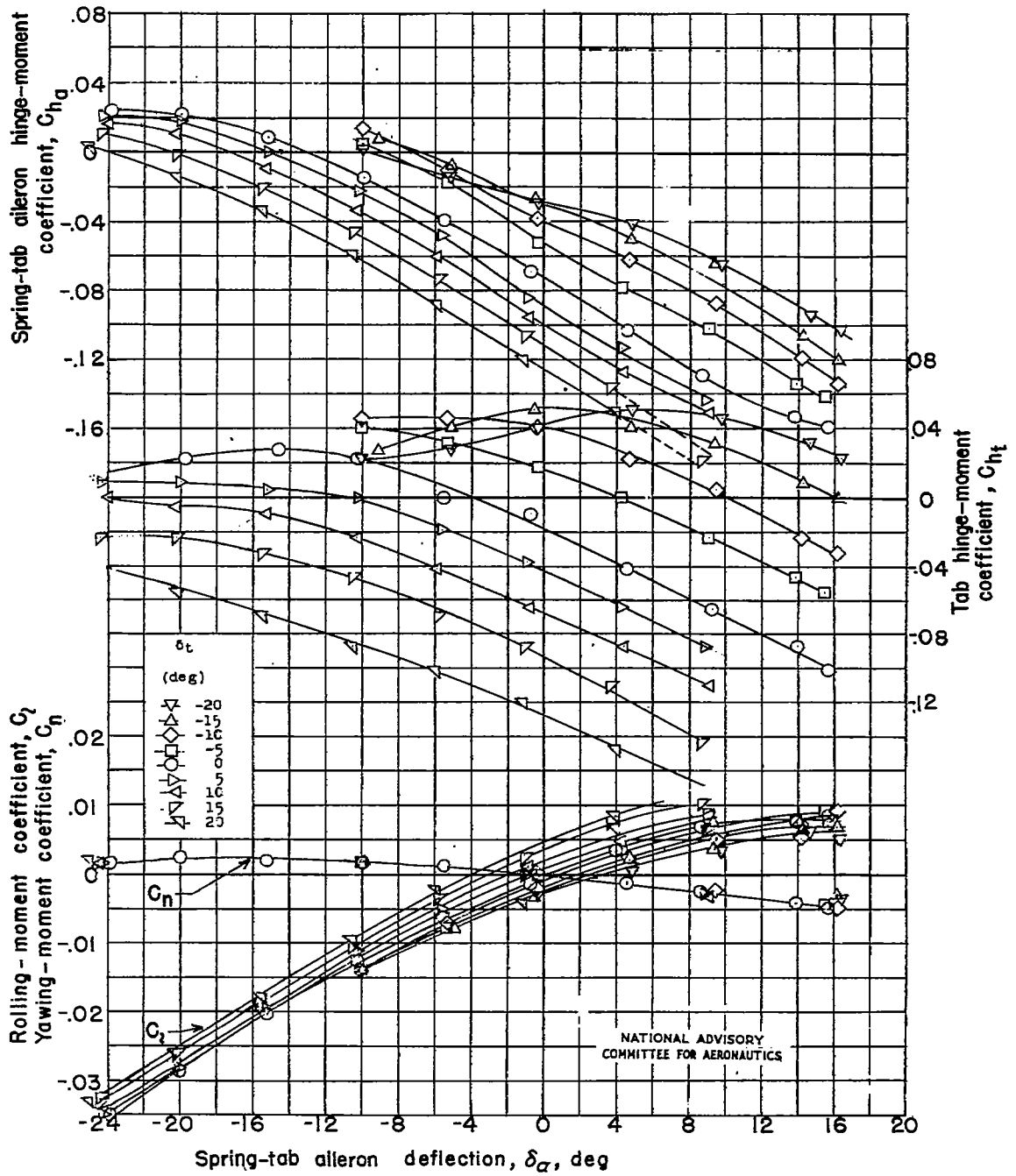
(a) $\alpha = 3.5^\circ$; flaps neutral.

Figure 5.- Representative data of the characteristics of the complete spoiler and pilot aileron from which the control-force characteristics were estimated.



(b) $\alpha = 12.3^\circ$; full-span double slotted flaps deflected 50° .

Figure 5.- Concluded.

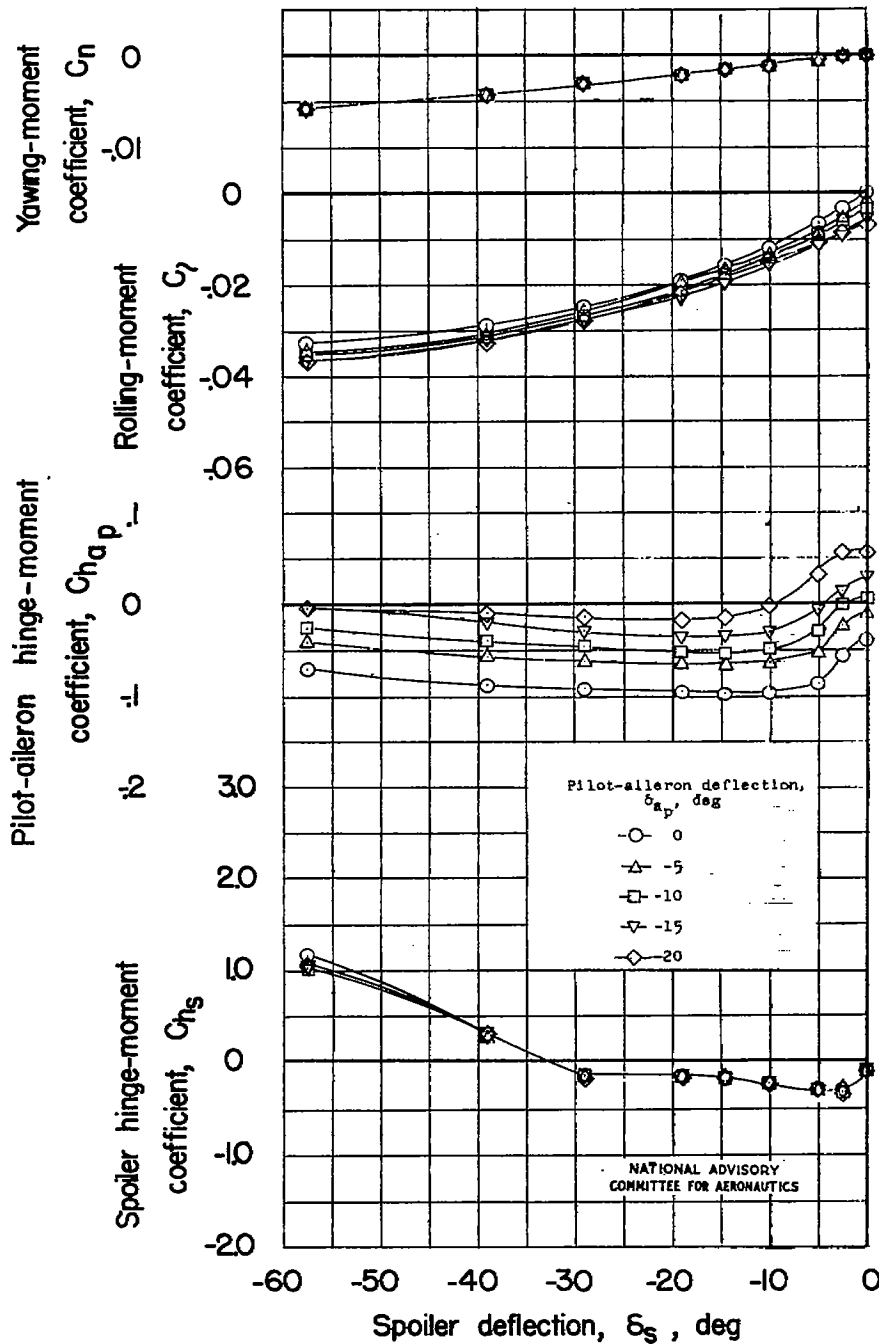
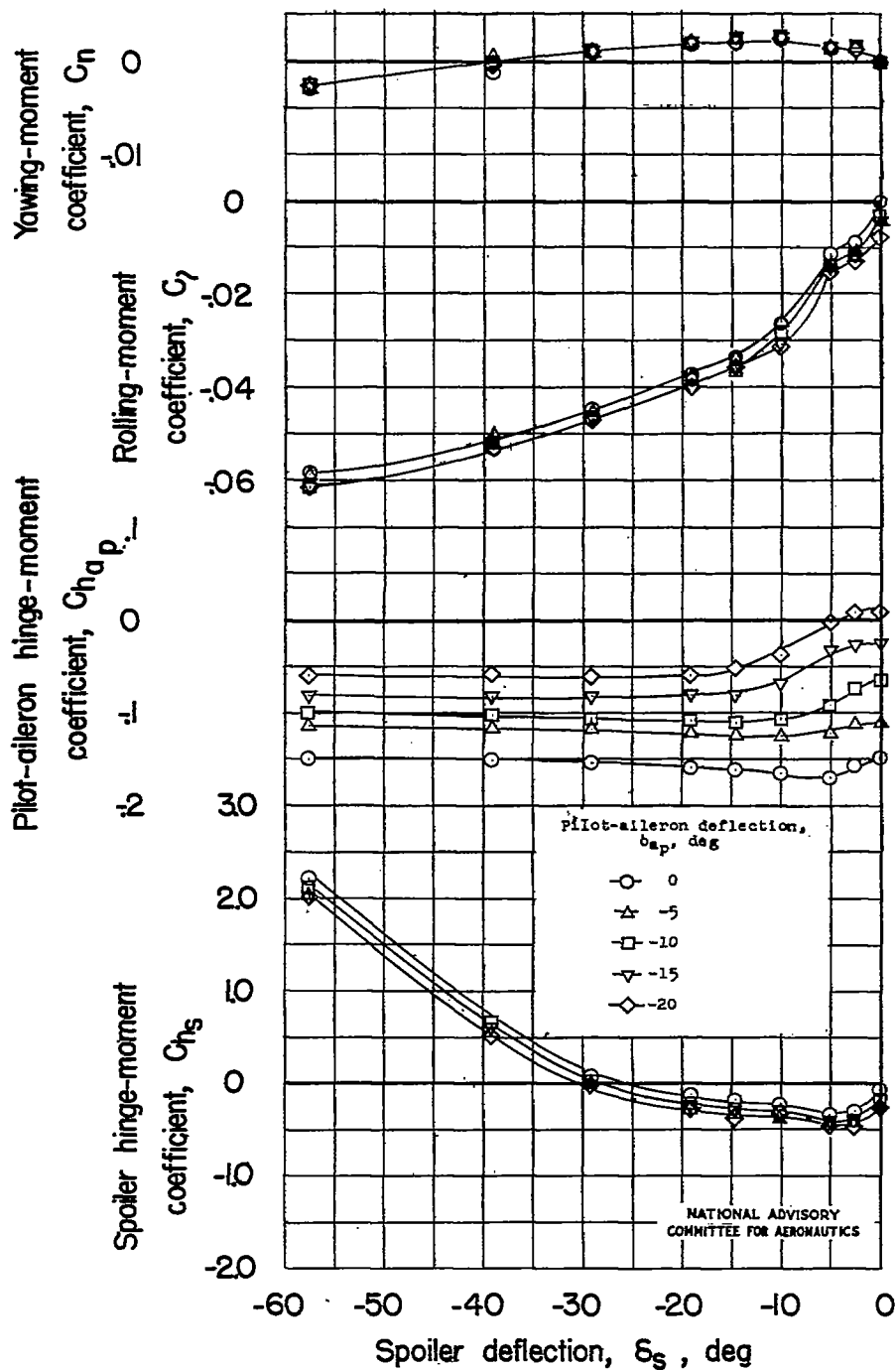
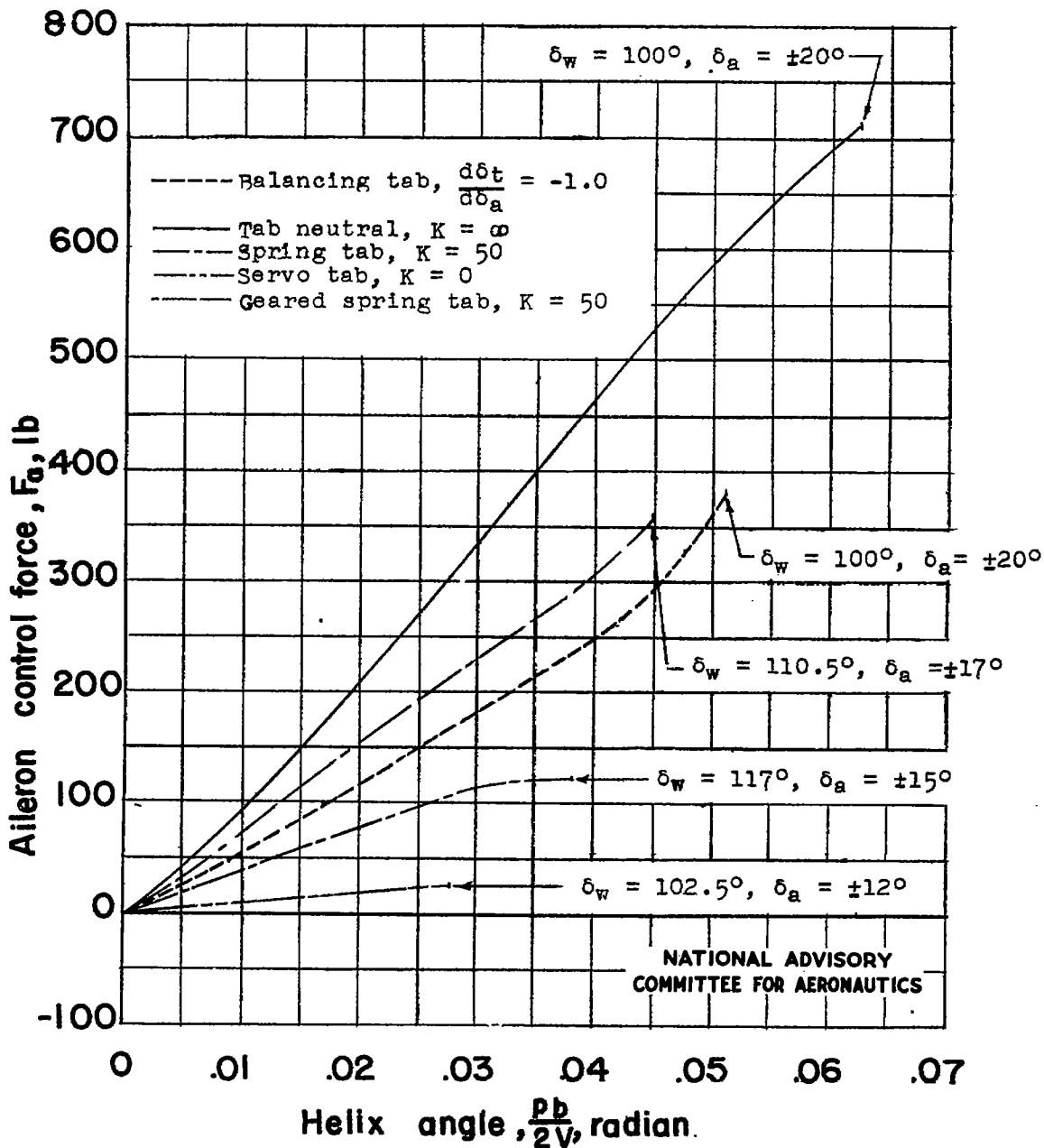

(a) Low-speed attitude. $\alpha = 14.0^\circ$; $V_i = 108$ miles per hour.

Figure 6.- Comparison of the variation of aileron control force with wing-tip helix angle for several aileron control systems including spring-tab systems having interconnected ailerons and a central spring unit.

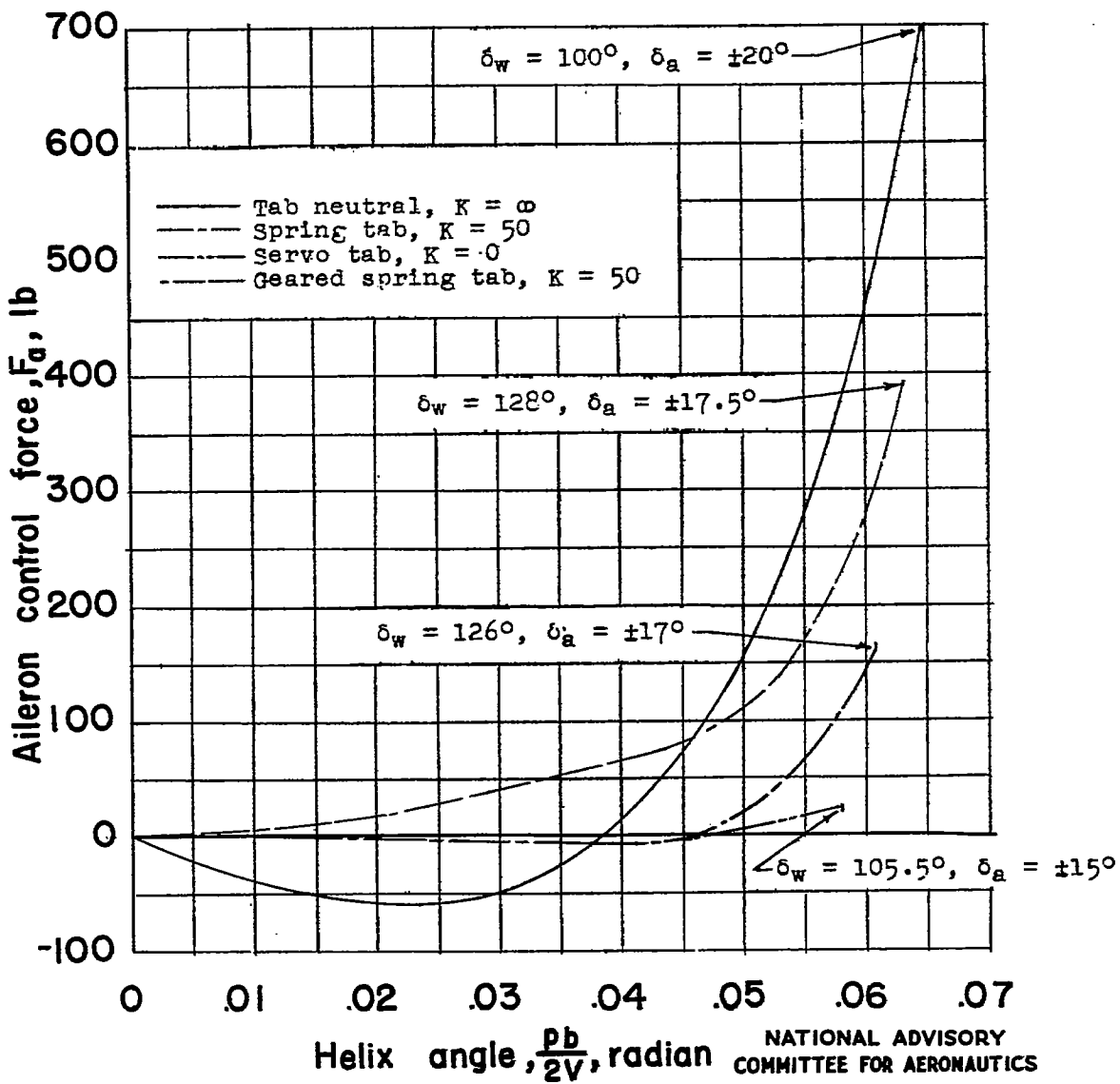

(b) High-speed attitude. $\alpha = 3.5^\circ$; $V_i = 198$ miles per hour.

Figure 6.- Concluded.

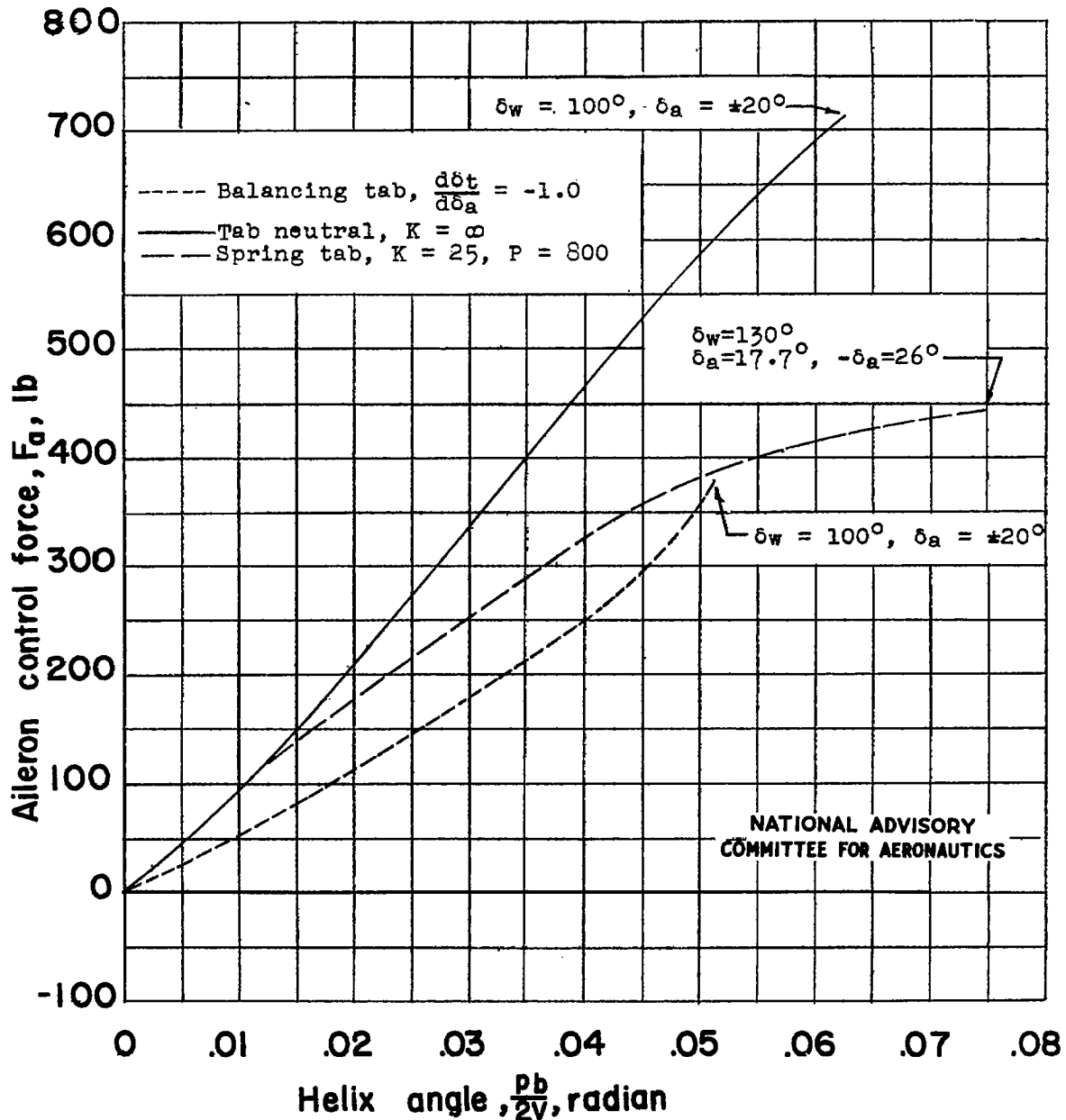

(a) Low-speed attitude. $\alpha = 14.0^\circ$; $V_1 = 108$ miles per hour.

Figure 7.- Comparison of the variation of aileron control force with wing-tip helix angle for several aileron control systems including a spring-tab system having no interconnection between ailerons.

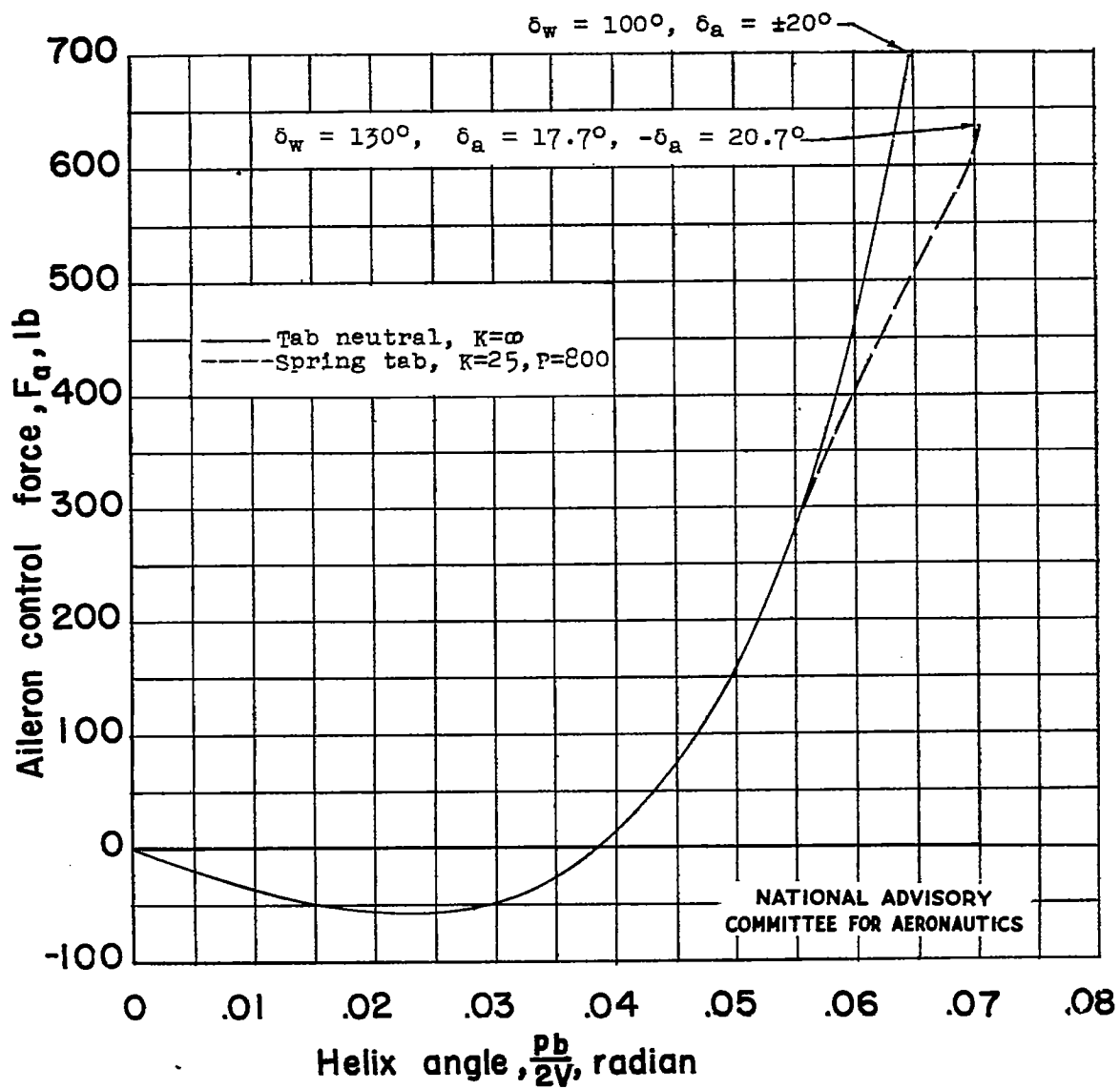

(b) High-speed attitude. $\alpha = 3.5^\circ$; $V_i = 198$ miles per hour.

Figure 7.- Concluded.

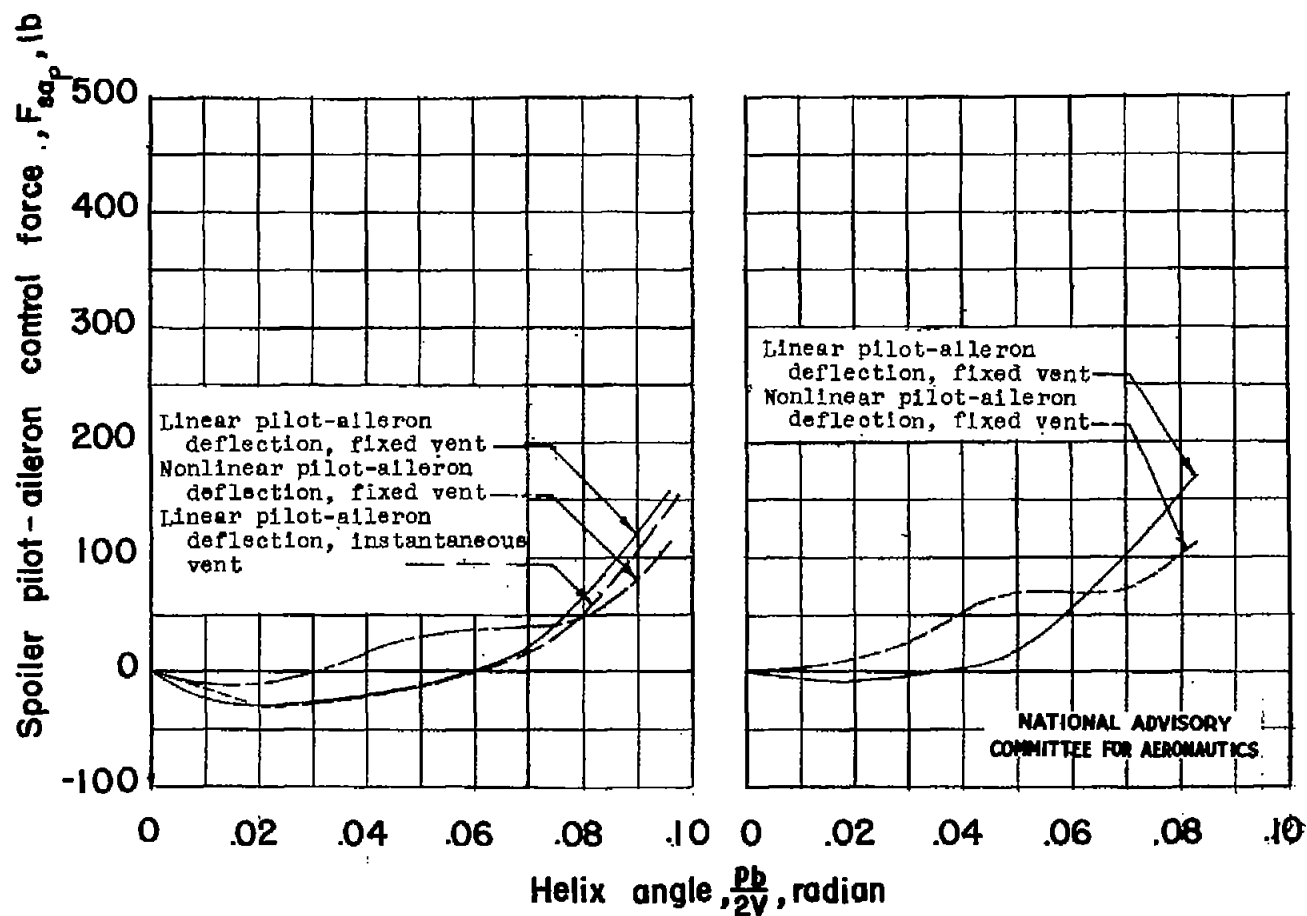

(a) Complete spoiler.

(b) Partial spoiler.

Figure 8.- Comparison of the variation of spoiler pilot-aileron control force with wing-tip helix angle in a low-speed attitude for several spoiler control configurations. $\alpha = 11.0^\circ$; $V_i = 100$ miles per hour.

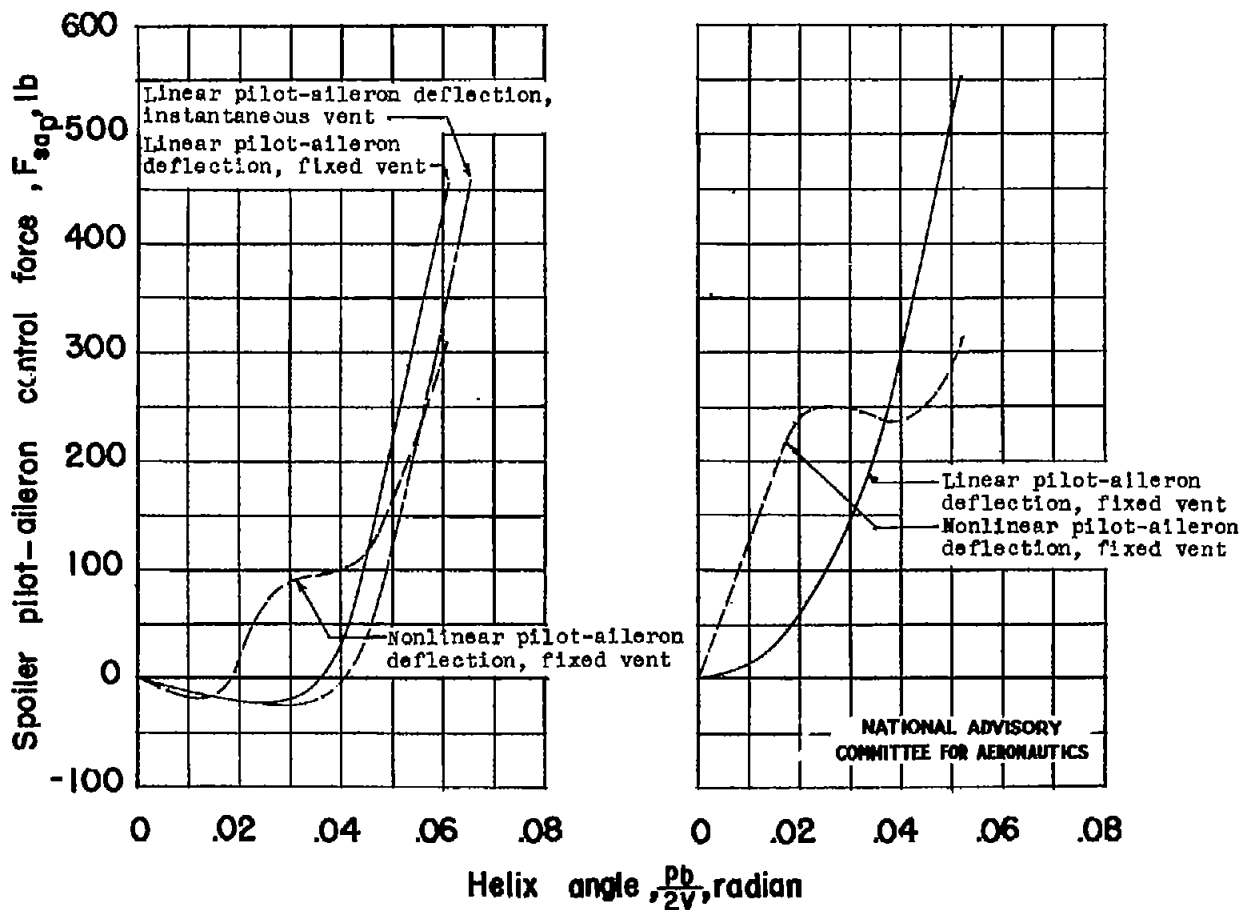

(a) Complete spoiler.

(b) Partial spoiler.

Figure 9.- Comparison of the variation of spoiler pilot-aileron control force with wing-tip helix angle in a high-speed attitude for several spoiler control configurations. $\alpha = 3.5^\circ$; $V_i = 198$ miles per hour.