

APR 25 1947  
NATIONAL ADVISORY COMMITTEE  
FOR AERONAUTICS

TECHNICAL NOTE

No. 1235

AN INVESTIGATION OF A THERMAL ICE-PREVENTION SYSTEM FOR A  
CARGO AIRPLANE. VIII - METALLURGICAL EXAMINATION OF THE  
WING LEADING-EDGE STRUCTURE AFTER 225 HOURS OF FLIGHT  
OPERATION OF THE THERMAL SYSTEM

By Maxwell Harris and Bernard A. Schlaff

Ames Aeronautical Laboratory  
Moffett Field, Calif.



Washington

April 1947

NACA LIBRARY  
LANGLEY MEMORIAL AERONAUTICAL  
LABORATORY  
Langley Field, Va.



NATIONAL ADVISORY COMMITTEE FOR AERONAUTICS

TECHNICAL NOTE NO. 1235

AN INVESTIGATION OF A THERMAL ICE-PREVENTION SYSTEM FOR A CARGO AIRPLANE. VIII.- METALLURGICAL EXAMINATION OF THE WING LEADING-EDGE STRUCTURE AFTER 225 HOURS OF FLIGHT OPERATION OF THE THERMAL SYSTEM.

By Maxwell Harris and Bernard A. Schlaff.

SUMMARY

As a part of a comprehensive investigation of a thermal ice-prevention system for a large cargo airplane, a metallurgical examination of the material used in the fabrication of the system has been made after 225 hours of actual flight operation of the heating installation.

Specimens of Alclad 24S-T aluminum alloy sheet taken from the thermal system were examined for the extent of corrosion and for changes in tensile strength as a result of aging of the aluminum alloy by the elevated temperatures. The examination indicated only minor corrosion and no impairment of tensile strength. In the section of the system where the heated air entered, there was a marked increase in yield strength accompanied by a decrease in elongation. A slight gain in ultimate strength was also noted at the heated-air entrance.

Microphotographs of sections of Alclad 24S-T aluminum alloy taken from the wing system are presented showing the extent of corrosion and the effect of temperature on the microstructure of the alloy.

INTRODUCTION

During the development of thermal ice-prevention systems for airplanes by the NACA, certain problems were encountered which were considered to be of a secondary nature in importance and, therefore, their investigation was deferred. One such problem is the possible deleterious effects to the airplane structure introduced by the circulation of free-stream air at elevated temperatures through the heating system.

A consideration of the possible detrimental consequences attending the circulation of free-stream air at elevated temperatures indicated that (1) portions of the internal structure might be impaired in strength or resistance to corrosion by artificial aging at the elevated temperatures, and (2) corrosive media might be inducted with the free-stream air and deposited in wing interiors.

With regard to the artificial aging of aluminum alloys, considerable laboratory research has been conducted on the effects of reheating aluminum alloys which have previously been heat-treated to the desired commercial condition. The tests described in reference 1 indicate that there is no appreciable change in the strength characteristics or corrosion resistance of Alclad 24S-T aluminum alloy as the result of aging for 20 hours at temperatures not exceeding 300° F. In the case of bare 24S-T aluminum alloy, however, the susceptibility to intercrystalline corrosion is definitely increased by heating to temperatures over 212° F. (See reference 2.) Reference 3 is in agreement with reference 1 with respect to the strength characteristics of Alclad 24S-T when the material is aged for 10 hours at temperatures not exceeding 300° F.

The possibility of corrosion is always present in aircraft structures and this possibility assumes greater importance when the corrosion resistance of the structure may have been reduced by overheating. The probability of corrosion is increased in the case of a wing incorporating a thermal ice-prevention system with free-stream air as the heat-transfer medium because of the corrosive media which may be inducted into the wing interior. In such a system the free-stream air, containing supercooled water drops and possibly snow, passes through a heat exchanger located in the engine exhaust-gas stream and then circulates through the wing interior.

The passage of this hot, moist air over surfaces of Alclad 24S-T would not be expected to cause appreciable corrosion were it not for the fact that condensation may occur and that the condensation invariably contains dissolved substances. Cloud drops usually contain dissolved oxygen along with other substances common to certain regions (e.g., chlorides from sea water). The water resulting from condensation acts as an electrolyte, allowing galvanic action, which is especially difficult to combat in such a complex structure as an airplane wing. If there is any leakage of exhaust gas into the system, sulphides, bromides, and carbonates may be introduced. The acids which may result from the combination of these radicals with the condensation are corrosive to aluminum alloys.

The purpose of the investigation reported herein was to examine the structural material of the thermal ice-prevention system, installed by the Ames Aeronautical Laboratory in the wings of a Curtiss-Wright C-46 airplane (fig. 1), after 225 hours of operation of the system in flight, to determine whether the high temperatures existing had produced any deleterious aging effects on the aluminum alloy, and

also to search for evidences of corrosive action which could be attributed to the thermal system.

The metallurgical examination of the wing structure was conducted at the Ames Aeronautical Laboratory in cooperation with the Air Materiel Command of the Army Air Forces and is the eighth of a series of reports which describe a comprehensive investigation of a practical thermal ice-prevention system. The first seven reports of the series are presented as references 4 to 10.

#### SELECTION OF SPECIMENS AND TEST PROCEDURE

The wing thermal system of the C-46 airplane is described in detail in reference 6 and temperatures of the structure measured during operation of the system are presented in references 7 and 10. All the wing structural material is Alclad 24S-T aluminum alloy. Representative specimens for tensile testing and microscopic examination were removed from the left wing after about 225 hours of flight operation of the thermal system. The locations from which the specimens were taken are shown in figure 2. The samples for microscopic examination were taken from the baffle plate at stations 14, 15, 48, and 104, from the nose ribs at stations 11 and 22, and from the nose outer skin at station 11. Tensile specimens were taken from the baffle plate at stations 16, 19, 20, 21, 45, 47, 49, 102, 108, and 109. The strips were cut from the baffle plate in a direction normal to the direction of rolling of the sheet.

The preparation of samples for microexamination consisted of hand-grinding the cross section on paraffined French Emory paper (numbers 0 through 0000), lapping on broadcloth using "cellite" as the abrasive, followed by a chamois lap using jewelers rouge as the abrasive. The polished samples were double-etched with nitric acid (a hot 25-percent solution) and Keller's etch according to the techniques described in references 11 and 12. Microexamination and microphotographs were made with a Bausch and Lomb table model microscope utilizing a carbon-arc light source.

The tensile specimens were milled to size according to the A.S.T.M. standard designation E3-42 (as described in reference 13) for sheet specimens 0.005 inch to 0.500 inch in thickness, using a 2-inch-gage length. However, in the course of preparation of the specimens, there was a breakdown of the milling machine and some of the samples were mutilated at the reduced section. This necessitated cutting down some of the specimens at the reduced section to 0.400-inch width. Samples at stations 45, 108, and 109 had the standard width of 0.500 inch; whereas samples at stations 16, 19, 20, 21, 47, 49, and 102 were remilled to provide a reduced width of 0.400 inch. The data for the tensile stress-strain curves were obtained on a

Southwark-Emery tensile testing machine with an extensometer capable of being read to 0.0001 inch per inch of gage length. The yield strengths were obtained from the stress-strain curves at 0.2-percent offset and the elongation of each specimen at fracture was procured by measuring its increase over the original 2-inch-gage length to the nearest 0.010 inch.

## RESULTS AND DISCUSSION

Visual examination of the baffle plate revealed a light deposit of soil accompanied by an appearance of slight pin-point corrosion as shown in figure 3. After removal of the soil, the positive presence of corrosion was established and is shown in figure 4. The large black lumps adhering to the sheet (seen in fig. 3) were identified as particles from a synthetic sponge-rubber gasket which was located at the inboard end of the transition duct (station 0, fig. 2). The heat had disintegrated a portion of the gasket and the hot air had carried the particles into the ducting where they had deposited and hardened on the surface of the baffle plate. Beneath these black lumps of synthetic rubber a severe corrosion was noted. Examination of a cross section of the baffle plate, indicated by the line A-A on figure 3, revealed a marked pitting of the cladding, but a normal core (fig. 5). Microexamination of a cross section beneath another particle at station 14 showed a definite attack of the core along the grain boundaries (fig. 6). The fact that the synthetic rubber particles set up intercrystalline corrosion at station 14 and not at station 59 may be attributed to the probably higher baffle-plate temperature at station 14 and thus a greater susceptibility to intercrystalline corrosion at that station.

A further examination of the cross section of the baffle plate at station 14 revealed a decidedly aged core structure (fig. 7). There is a heavy precipitation at the grain boundaries and within the grains. Long periods of heating have begun a coalescence of the precipitation resulting in relatively large rounded particles. There is also a considerable decrease in grain contrast. Aluminum alloys exhibiting such a structure are reported in reference 12 to be quite susceptible to intercrystalline corrosion.

Microexamination of the section of the web of the nose rib at station 11 shows minute amounts of precipitation at the grain boundaries (fig. 8), but it is not believed that any excessive temperature effects are indicated. References 1, 3, and 14 report that Alclad 24S-T may be aged artificially without detrimental effect; provided the correct combination of temperature and time at the elevated temperature is maintained.

Figures 9 and 10 show the structures of the leading-edge outer-skin station 11 and in the web of the nose rib station 22. These microstructures are comparable to that of normal 24S-T as reported in reference 11. The highest temperature recorded at the nose rib station 22 was 256° F (reference 7) but no temperature data are available for the area of the nose skin at station 11.

A section examination of the baffle plate at station 15 showed a structure identical to that of figure 7, while examination of baffle-plate sections at stations 48 and 104 showed structures similar to figures 9 and 10. This indicates that the overheating of the baffle plate and attendant reduction in resistance to corrosion did not extend to station 48.

The results of the tensile tests of the sections taken from the baffle plate at various stations are given in table I. A consideration of these values indicates that, at the area where the heated air was at the highest temperature, there is a substantial increase in yield strength over that normally obtained with room-temperature-aged Alclad 24S-T. The elevated temperature of the structure in that area has resulted in artificial aging of the aluminum alloy. Accompanying the change in yield strength is also a slight increase in ultimate tensile strength and a decrease in elongation. Figure 11 shows the tensile test specimens after fracture. Although there has been some significance attached to the fracture characteristics of aged tensile specimens by some investigators, the irregularity of the fractures, as shown in figure 11, precludes the possibility of obtaining any conclusive information. Such anomalous fracture behaviour may be attributed, in part, to a point-to-point metallurgical difference in some specimens due to the point-to-point temperature variations encountered in the thermal ice-prevention system. Fracture of the specimens from stations 19, 45, and 108 took place outside the middle third of the gage length, but it is felt the strength and elongation values are representative, as they are in good agreement with accompanying data.

It may be noted in table I that from station 16 to 21, a distance of only 5 inches, there is a continuous decrease in yield strength and an attendant gain in elongation, approaching room-temperature values. This indicates an effective differential in temperature, even over this short distance, substantiating investigations (reference 3) on the artificial aging of Alclad 24S-T which have revealed that in a critical temperature range of from 300° F to 375° F small differences in temperature may cause quite noticeable changes in yield strength. The values obtained for the ultimate tensile strength and yield strength for the specimens from stations 45, 47, 49, 102, 108, and 109 do not indicate any marked temperature-aging effect as they compare closely with the figures given in reference 15. The stress-strain curve for each specimen is shown in figure 12. This figure shows clearly the

increased ultimate and yield strengths of the specimens from stations 16 to 21 resulting from artificial aging. The yield at 0.2-percent offset is indicated by the short intercept line at the knee of each curve. Essentially, the modulus of elasticity is the same for all curves, which is normal for room-temperature tensile tests of this material.

### CONCLUSIONS

The following conclusions are based upon the microscopic and tensile test examination of the wing structural material affected by a thermal ice-prevention system installed in a C-46 airplane:

1. The ultimate and yield strengths of the Alclad 24S-T aluminum alloy comprising the wing structure were not reduced by aging due to the elevated temperatures associated with the operation of the system. In some instances these strengths were increased as a result of artificial aging.
2. No corrosive effects were noted which could be attributed to the basic principle of employing free-stream air (heated by an exhaust-gas-to-air heat exchanger) as the heat-transfer medium in an internal circulatory system.
3. Overheating of the internal structure can produce increased susceptibility to corrosion.

Ames Aeronautical Laboratory,  
National Advisory Committee for Aeronautics,  
Moffett Field, Calif., Feb. 13, 1947.

### REFERENCES

1. Mozley, Paul P.: Elevated Temperature Aging of 24S Aluminum Alloy. Jour. Aero. Sci., vol. 10, no. 6, June 1943, pp. 180-184.
2. Mutchler, Willard: The Effect of Continuous Weathering on Light Metal Alloys Used in Aircraft. NACA Rep. No. 663, 1939.
3. Kotanchik, Joseph N., Woods, Walter, and Zender, George W.: The Effect of Artificial Aging on the Tensile Properties of Alclad 24S-T Aluminum Alloy. NACA RB No. 3H23, 1943.

4. Neel, Carr B. Jr.: An Investigation of a Thermal Ice-Prevention System for a C-46 Cargo Airplane. I - Analysis of the Thermal Design for Wings, Empennage, and Windshield. NACA ARR No. 5A03, 1945.
5. Jackson, Richard: An Investigation of a Thermal Ice-Prevention System for a C-46 Cargo Airplane. II - The Design, Construction, and Preliminary Tests of the Exhaust-Air Heat Exchanger. NACA ARR No. 5A03a, 1945.
6. Jones, Alun, R., and Spies, Ray J., Jr.: An Investigation of a Thermal Ice-Prevention System for a C-46 Cargo Airplane. III - Description of Thermal Ice-Prevention Equipment for Wings, Empennage, and Windshield. NACA ARR No. 5A03b, 1945.
7. Selna, James, Neel, Carr B., Jr., and Zeiller, E. Lewis: An Investigation of a Thermal Ice-Prevention System for a C-46 Cargo Airplane. IV - Results of Flight Tests in Dry-Air and Natural-Icing Conditions. NACA ARR No. 5A03c, 1945.
8. Selna, James: An Investigation of a Thermal Ice-Prevention System for a C-46 Cargo Airplane. V - Effect of Thermal System on Airplane Cruise Performance. NACA ARR No. 5D06, 1945.
9. Selna, James, and Koes, Harold L.: An Investigation of a Thermal Ice-Prevention System for a C-46 Cargo Airplane. VI - Dry-Air Performance of Thermal System at Several Twin and Single-Engine Operating Conditions at Various Altitudes. NACA ARR No. 5C20, 1945.
10. Jones, Alun R., and Schlaff, Bernard A.: An Investigation of a Thermal Ice-Prevention System for a C-46 Cargo Airplane. VII - Effect of the Thermal System on the Wing-Structure Stresses as Established in Flight. NACA ARR No. 5G20, 1945.
11. Koller, F., and Bossert, R. A.: Revealing the Microstructure of 24S Alloy. Tech. Paper No. 8, Aluminum Res. Lab., Aluminum Co. of Am., 1942.
12. Keller, F., and Brown, R. H.: The Heat Treatment of 24S and Alclad 24S Alloy Products. Tech. Paper No. 9, Aluminum Res. Lab., Aluminum Co. of Am., 1943.
13. Anon: Tension Testing of Metallic Materials. A.S.T.M. Standards, Part I - Metals, 1944.



14. Flanigan, A. E., Tedsen, L. F., and Dorn, J. E.: Final Report on Study of the Forming Properties of Aluminum Sheet at Elevated Temperatures: Part X - Tensile Properties After Prolonged Times at Temperature. Serial W-146. NDRC Research Project NRC-548, WPB-128, Oct. 20, 1944.
15. Templin, R. L., Hartmann, E. C., and Paul, D. A.: Typical Tensile and Compressive Stress-Strain Curves for Aluminum Alloy 24S-T, Alclad 24S-T, 24S-RT, and Alclad 24S-RT Products. Tech. Paper No. 6, Aluminum Res. Lab., Aluminum Co. of Am., 1942.

TABLE I.—RESULTS OF TENSILE TESTS OF ALCLAD 24S-T SPECIMENS  
TAKEN FROM THE BAFFLE PLATE OF THE C-46 AIRPLANE  
WING THERMAL ICE-PREVENTION SYSTEM

Station	Yield strength (lb/sq in.)	Ultimate strength (lb/sq in.)	Elongation in 2 inches (percent)
16	59,500	65,600	6
19	58,200	65,600	7
20	55,600	65,000	8.5
21	54,600	65,000	10
45	43,000	62,500	16
47	43,400	62,500	16.5
49	44,700	62,500	17
102	44,400	62,500	16
108	44,600	63,500	17.5
109	44,200	63,600	18

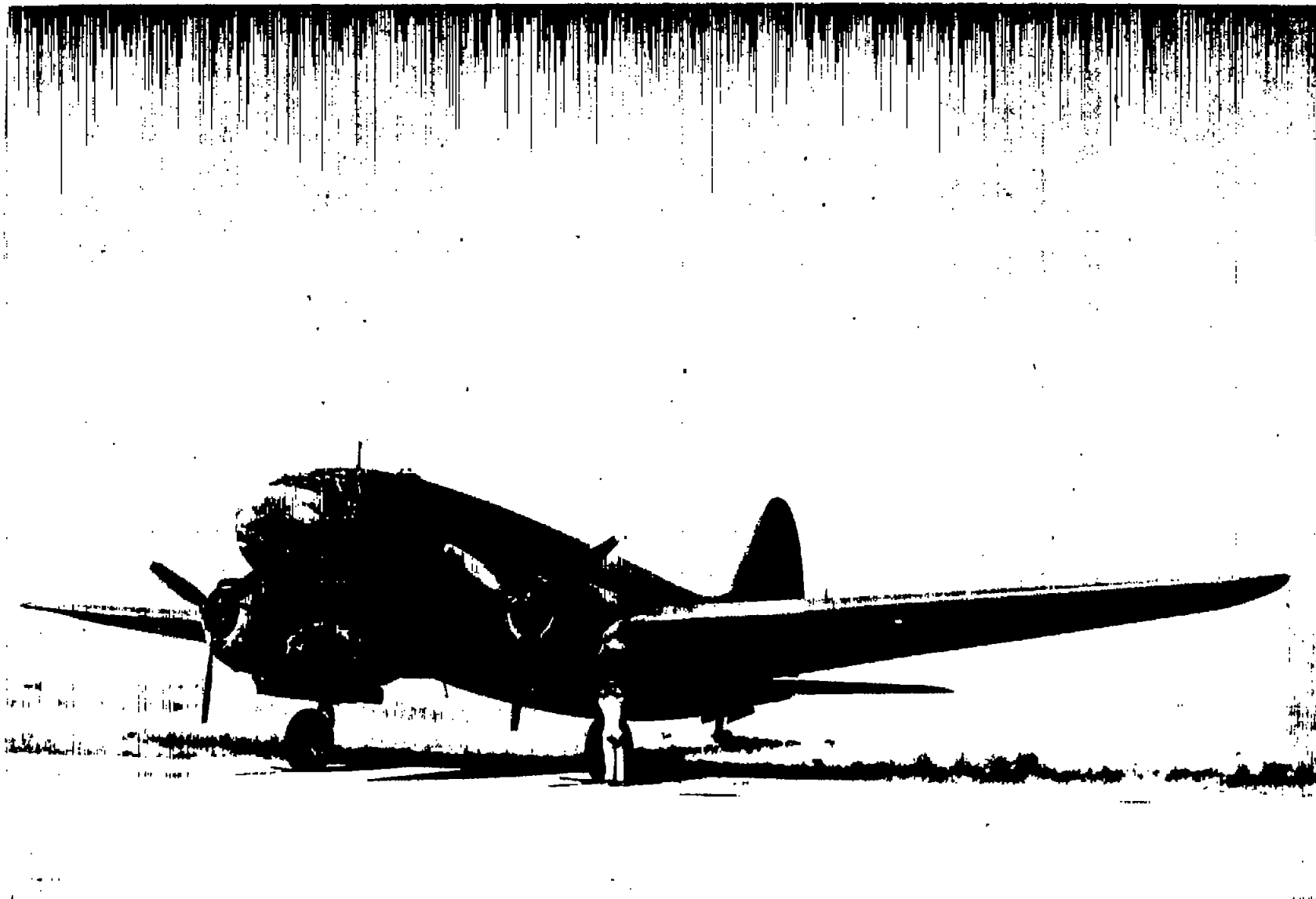
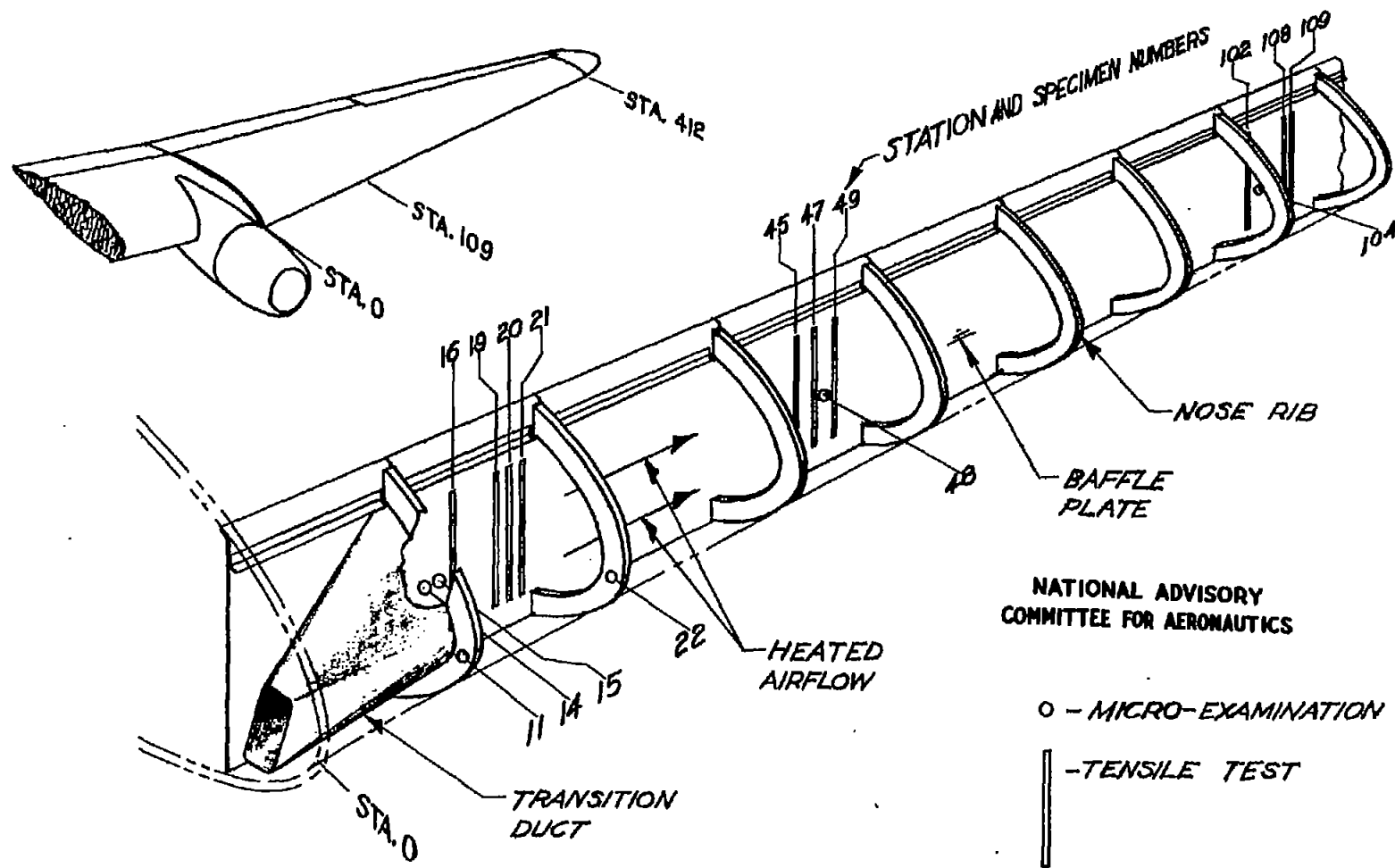

Figure 1.- The C-46 airplane equipped with a thermal ice-prevention system.



NOTE: SPECIMEN FROM LEADING EDGE OUTER SKIN TAKEN AT STATION 11 NOT SHOWN.

FIGURE 2.- LEADING EDGE OF THE LEFT WING OUTER PANEL SHOWING LOCATION OF SPECIMENS TAKEN FOR MICRO-EXAMINATION AND TENSILE TESTS, C-46 AIRPLANE.



Figure 3.- Corrosion and soil deposit on baffle plate between stations 56 and 60. The large black spots are particles from a synthetic sponge-rubber gasket.

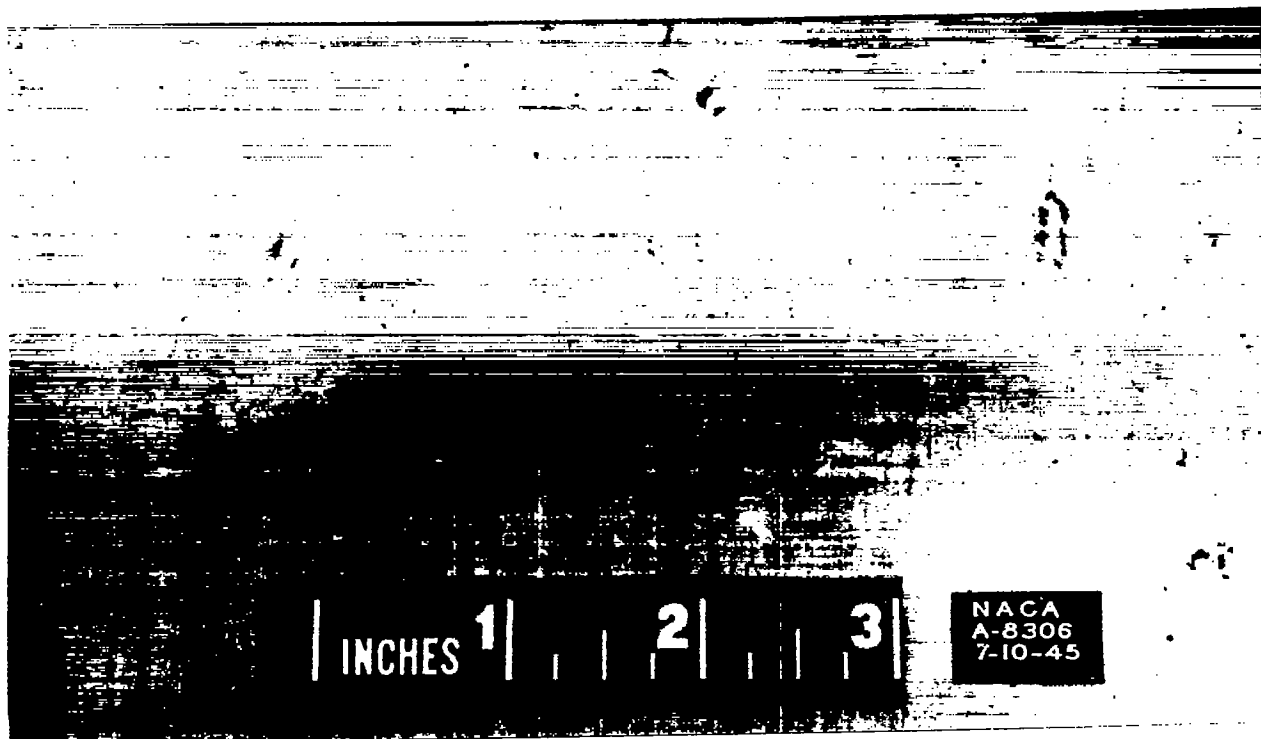

Figure 4.- Area of baffle plate shown in figure 3 after cleaning with acetone.

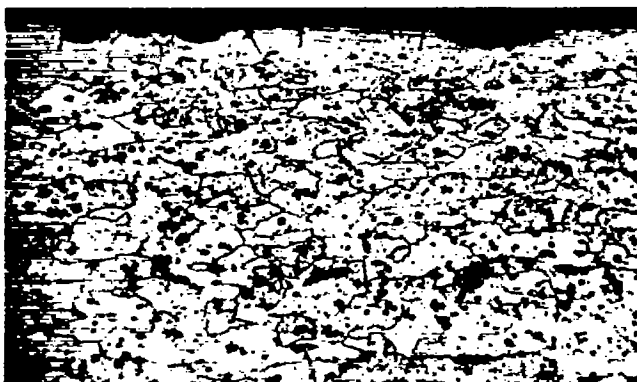

Figure 5.- Cross section of baffle-plate cladding and core beneath the synthetic rubber particle at section A-A, figure 3. Magnification, 200X; Keller's etch. Pitting is severe but has not penetrated the cladding.



Figure 6.- Cross section of baffle-plate cladding and core at station 14, showing intercrystalline corrosion. Magnification, 250X; Keller's etch, and hot 25-percent solution of nitric acid.

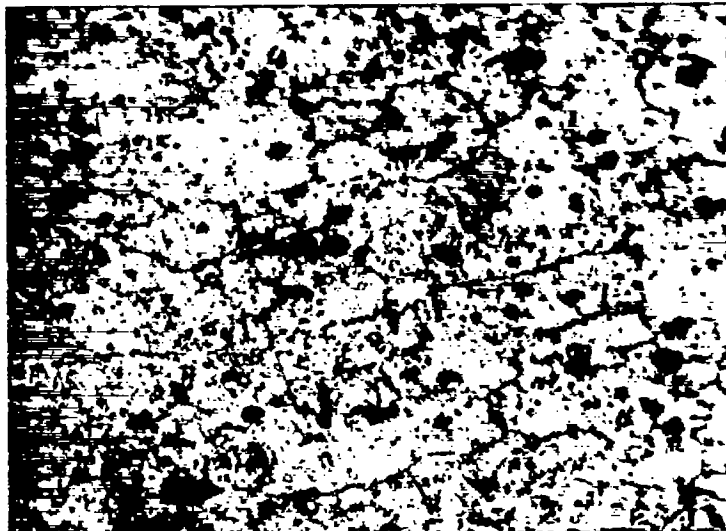

Figure 7.- Section showing core structure of baffle plate at station 14. Magnification, 500X; double-etched with hot 25-percent solution of nitric acid and Keller's etch. Precipitation is evident at and within the grain boundaries.



Figure 8.- Section showing core structure of nose-rib web at station 11. Magnification, 500X; double-etched with hot 25-percent solution of nitric acid and Keller's etch.



Figure 9.- Section showing core structure of leading-edge outer skin at station 11. Magnification, 500X; double-etched with hot 25-percent solution of nitric acid and Keller's etch.

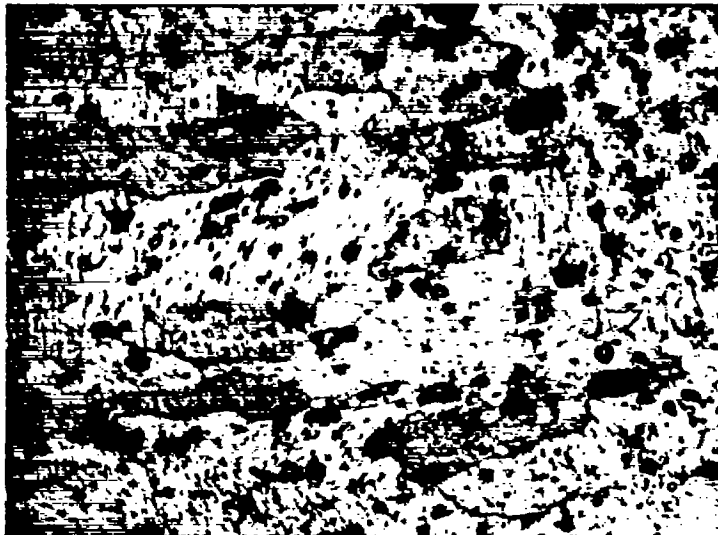
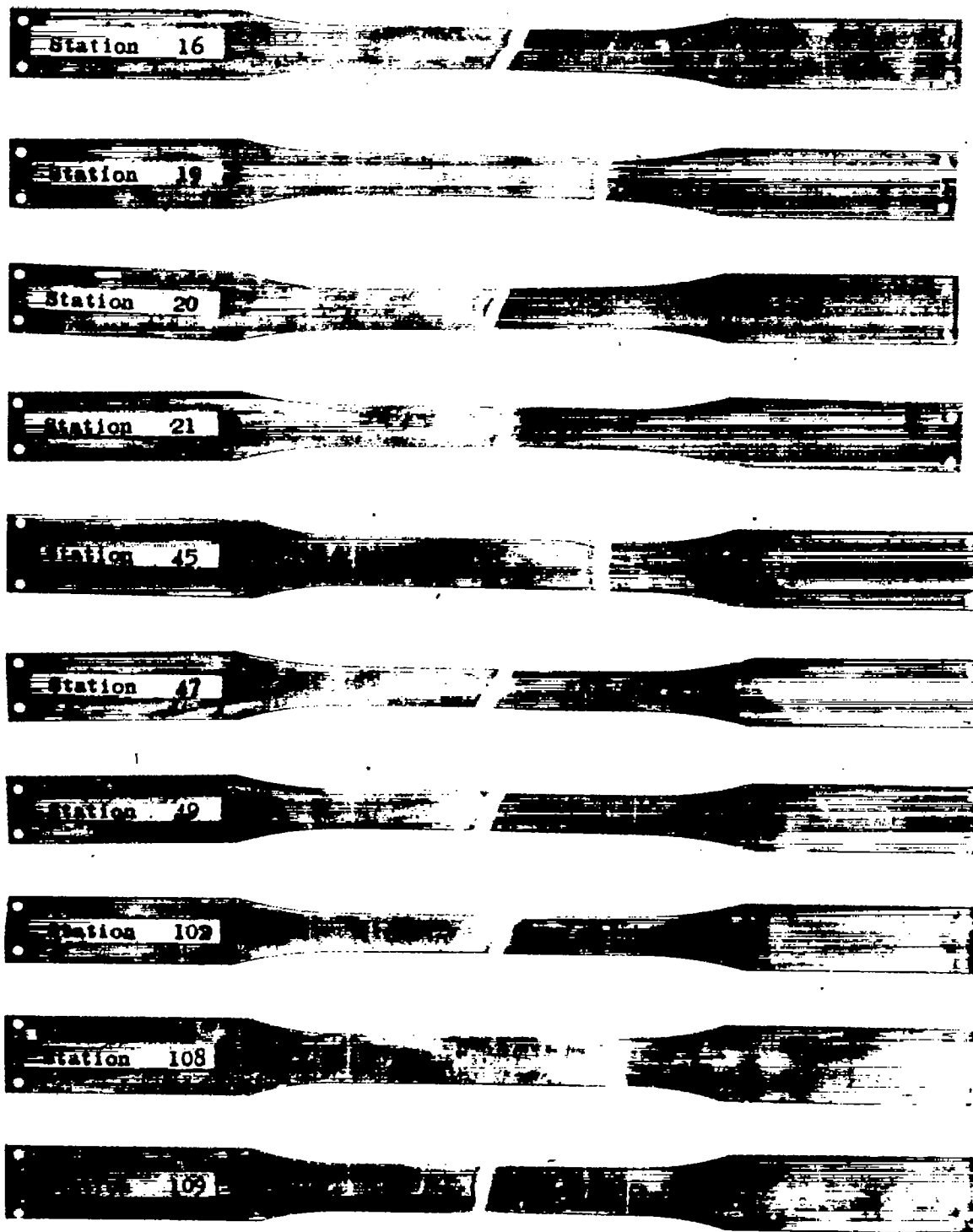

Figure 10.- Section showing core structure of nose-rib web at station 22. Magnification, 500X; double-etched with hot 25-percent solution of nitric acid with Keller's etch.





INCHES 1 | 2

NACA  
A-10388  
8-22-46

Figure 11.- Alclad 24S-T tensile specimens, taken from the baffle plate of the C-46 airplane wing thermal system, after fracture.

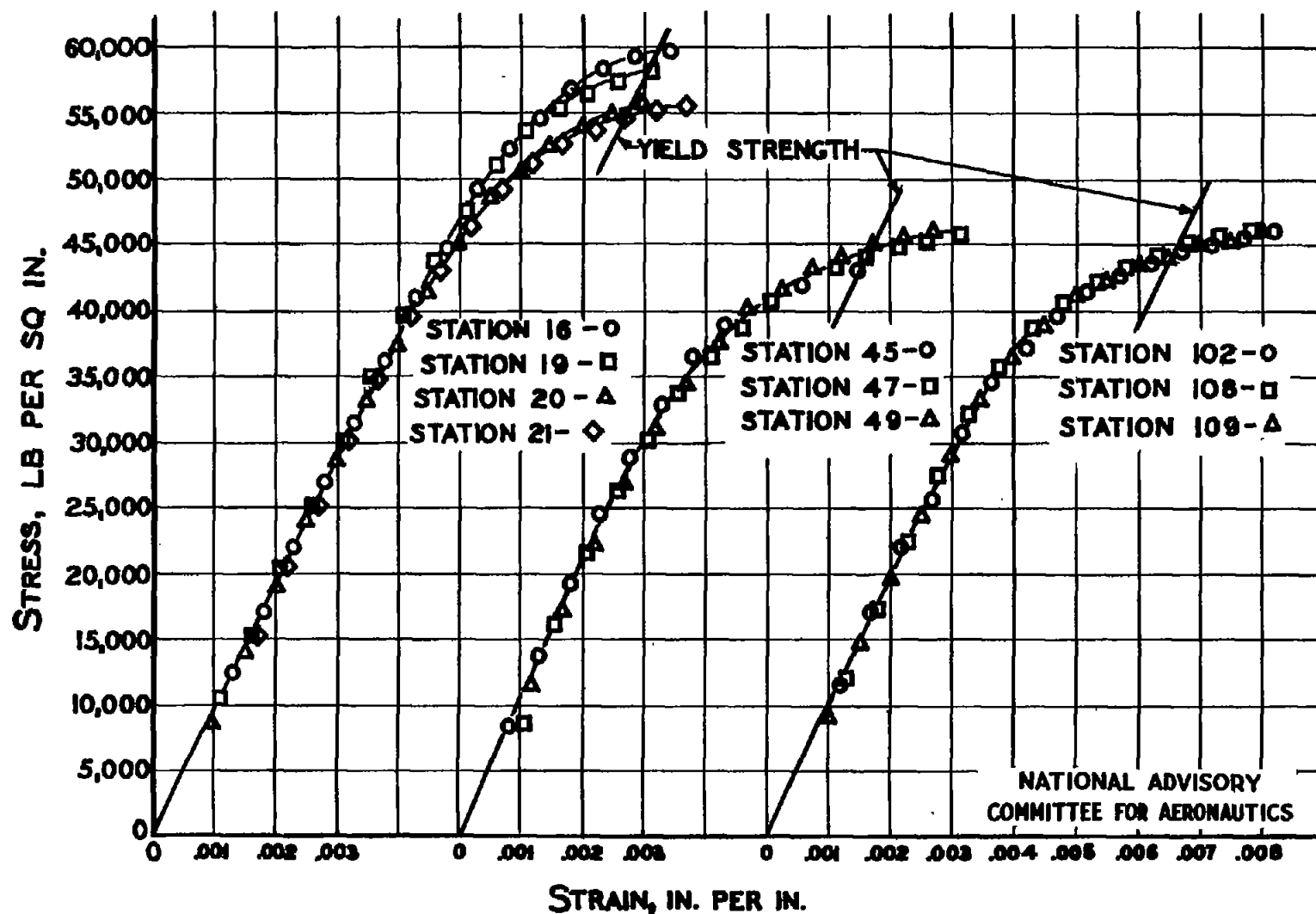

FIGURE 12- STRESS-STRAIN CURVES FOR ALCLAD 24S-T ALUMINUM ALLOY TEST SPECIMENS TAKEN FROM THE BAFFLE PLATE OF A THERMAL ICE-PREVENTION SYSTEM INSTALLED IN A C-46 AIRPLANE WING.