

RESTRICTED

RM No. A7I26



23 DEC 1947

# RESEARCH MEMORANDUM

PRELIMINARY RESULTS OF A FLIGHT INVESTIGATION TO  
 DETERMINE THE EFFECT OF NEGATIVE FLAP  
 DEFLECTION ON HIGH-SPEED LONGITUDINAL-  
 CONTROL CHARACTERISTICS

By

Maurice D. White, Melvin Sadoff,  
 Lawrence A. Clousing, and  
 George E. Cooper

Ames Aeronautical Laboratory  
 Moffett Field, Calif.

CLASSIFICATION CANCELLED

CLASSIFIED DOCUMENT

This document contains classified information affecting the National Defense of the United States within the meaning of the Espionage Laws, Title 18, USC 793 and 794. Its transmission or the revelation of its contents in any manner to an unauthorized person is prohibited by law. Information so classified may be imparted only to persons in the military and naval services of the United States, appropriate civilian officers and employees of the Federal Government who have a legitimate interest therein, and to United States citizens of known loyalty and discretion who of necessity must be informed thereof.

*J. W. Crowley* Date *12/14/53*  
*EC 10501*  
*JH 1-15-54* See *NACA*  
*R72155*

## NATIONAL ADVISORY COMMITTEE FOR AERONAUTICS

WASHINGTON

December 16, 1947

UNCLASSIFIED

RESTRICTED

NACA LIBRARY  
 LANGLEY MEMORIAL AERONAUTICAL  
 LABORATORY  
 Langley Field, Va.

*1104*  
~~*498*~~  
*Copy 2*



UNCLASSIFIED

## NATIONAL ADVISORY COMMITTEE FOR AERONAUTICS

RESEARCH MEMORANDUM

## PRELIMINARY RESULTS OF A FLIGHT INVESTIGATION TO

DETERMINE THE EFFECT OF NEGATIVE FLAP

DEFLECTION ON HIGH-SPEED LONGITUDINAL-

CONTROL CHARACTERISTICS

By Maurice D. White, Melvin Sadoff,  
Lawrence A. Clousing, and  
George E. Cooper

## SUMMARY

Flight tests were conducted on two propeller-driven airplanes having wings of NACA 66-series and NACA 230-series airfoil sections, respectively, to determine the effect of deflecting the landing flaps upward on the high-speed longitudinal-control characteristics. The flaps were deflected  $-6^\circ$  on the former and  $-4.5^\circ$  and  $-8.7^\circ$  on the latter. The results obtained indicated that on both airplanes the negatively deflected flaps had the desired effect of reducing the variation with Mach number of the airplane and horizontal-tail angles of attack at a constant value of airplane normal-force coefficient. For the airplane with the NACA 66-series airfoil, a decrease in the diving tendency at high Mach numbers resulted from the improvement in angle-of-attack variation. For the airplane with the NACA 230-series airfoil, however, no appreciable improvement in the diving tendencies resulted. It appears that for the latter airplane a detrimental change in the variation with Mach number of the pitching moment of the airplane without the tail offsets the favorable effect produced by the reduction of the angle-of-attack variation.

## INTRODUCTION

For conventional airplanes with unswept wings the problem of maintaining satisfactory longitudinal-control characteristics at supercritical speeds is still an impediment to further speed increases. One of the principal obstacles has been the diving tendencies which have been experienced at high Mach numbers with



UNCLASSIFIED

these airplanes. A large quantity of wind-tunnel data and some flight data have established the sources of the diving tendencies and several reports have been written summarizing the findings of these investigations (references 1, 2, and 3). The variation with Mach number of the wing angle of attack for a constant lift coefficient has been demonstrated to be one of the factors that strongly influence the diving tendency.

Recent two-dimensional tests on an NACA 65-210 airfoil in the Ames 1- by 3 $\frac{1}{2}$ -foot high-speed wind-tunnel showed that the changes in angle of attack to maintain a constant lift coefficient with Mach number were reduced progressively as a trailing-edge flap was deflected upward to 6.3 $^{\circ}$ , the highest angle tested. Similarly, results presented in reference 2 showed that on an airplane with a wing having an NACA 66-series airfoil section the diving tendencies were alleviated up to the highest test Mach number by reflexing the aft portion of the wing center section. From these results, it was surmised that an improvement in the diving tendencies of conventional airplanes might be obtained by deflecting the landing flaps upward. The relative simplicity of this operation as a possible solution for the problem makes it particularly attractive for airplanes with unswept wings now in service or currently being designed.

In order to establish the utility of the measure, flight tests were conducted at the Ames Aeronautical Laboratory on two modern propeller-driven fighter-type airplanes. One of these airplanes had a wing with an NACA 66-series airfoil section and the other had a wing with an NACA 230-series airfoil section.

Although the test programs have not been completed, some significant results have been obtained on both airplanes with the flaps undeflected and deflected upward. The present report has been prepared to show these results.

#### SYMBOLS

M	free-stream Mach number
q	free-stream dynamic pressure, pounds per square foot
C <sub>N</sub>	airplane normal-force coefficient ( $WA_z/qS$ )
W	airplane weight, pounds
A <sub>z</sub>	ratio of net aerodynamic force along airplane Z-axis (positive when directed upward) to weight of airplane

S	total wing area, square feet
$\delta_e$	elevator angle with respect to stabilizer chord-line, degrees
$\delta_f$	flap deflection (down-flap deflection positive), degrees
F	elevator stick force, pounds
$\alpha_A$	airplane angle of attack at fuselage reference line, degrees
$\alpha_t$	horizontal tail angle of attack, degrees

### AIRPLANES

The airplane having a wing of NACA 66-series airfoil section is designated in this report as airplane 1 and the airplane having a wing of NACA 230-series airfoil section is designated as airplane 2.

Three-view drawings of airplanes 1 and 2 are shown in figures 1 and 2, respectively, and three-quarter rear-view photographs are shown in figures 3 and 4. Pertinent dimensions of the two airplanes are presented in the following table:

Item	Airplane 1	Airplane 2
Gross weight, pounds (average during flight)	8200	9100
Wing area, square feet	235	244
Span, feet	37.0	35.5
Aspect ratio	5.82	5.17
Airfoil section		
Root, at airplane center line	NACA 66,2-(1.8)(15.5)	NACA 23018
Tip	NACA 66,1-(1.8)12	NACA 23009
M.A.C., inches	80.17	87.55
Incidence (root chord to fuselage reference line)	1.0°	-1.5°
Wing flaps, each		
Type	plain	slotted
Span, feet	9.5	9.65
Tip location, percent semispan	60	65
Chord, percent local chord		
Root	22	23
Tip	22	23

On both airplanes the wing guns were removed and the gun ports and cartridge-ejection slots were covered with doped fabric. When the flaps were deflected upward on the airplanes, the gaps between the flaps and the wing on the lower surfaces of both airplanes and on the upper surface of airplane 2 were covered by metal strips (figs. 5 and 6).

#### INSTRUMENT INSTALLATION

Standard NACA continuously recording instruments were used to record the variables measured.

The airspeed heads, a Kollsman type on airplane 2 and a swivelling-head type on airplane 1, were mounted on booms one-chord length ahead of the left-wing tip of the respective airplanes. No flight calibration was made of the airspeed recorder installations at high Mach numbers; for airplane 1, compressibility corrections for the airspeed head, as obtained from high-speed tunnel tests, were applied.

Airplane angle-of-attack measurements were obtained from directional pitot heads mounted on booms extending one-chord length ahead of the right wing tip of each airplane (fig. 7(a)). Corrections were applied to the readings of this head for compressibility as derived from tests of a similar type head in the Ames 1- by  $3\frac{1}{2}$ -foot wind tunnel. No corrections were applied for deflection of the boom or of the wing. Similar installations were used for determining the angle of attack of the horizontal tail (fig. 7(b)).

Control-position recorders were connected directly to the elevators and to the ailerons of airplanes 1 and 2 to record the deflections of these surfaces.

#### TESTS AND PROCEDURE

Tests were conducted on airplane 1 with the flaps undeflected and with the flaps deflected  $-6^\circ$ . On airplane 2 tests were made with the flaps undeflected and with the flaps deflected  $-4.5^\circ$  and  $-8.7^\circ$ . For each configuration, data were obtained at Mach numbers ranging from 0.4 to the maximum practicable, and for normal accelerations ranging from those of steady flight to values corresponding to an airplane normal-force coefficient of about 0.4. The test altitudes centered around 20,000 feet with variations not exceeding  $\pm 6,000$  feet.

For airplane 1 the center of gravity at take-off was at about 25-percent M.A.C. and moved forward during each flight to about 24-percent M.A.C. due to fuel consumption. The corresponding center-of-gravity movement of airplane 2 was from about 26-percent M.A.C. to approximately 25-percent M.A.C. No attempt was made to correct for these small variations in center-of-gravity position in the evaluation of the data.

Normal rated power was used throughout the tests of airplane 2. For airplane 1 normal-rated power was used for the dive tests and power required for level flight was employed at lower speeds.

The test procedures were substantially similar for airplanes 1 and 2. The airplanes were trimmed longitudinally at a Mach number of about 0.65 at an altitude of 20,000 feet. For each test Mach number, records were obtained in straight, steady flight or in steady dives. For higher accelerations, essentially static data were obtained in steady turns at a constant acceleration or, at the higher speeds, in steady dive pull-outs during which the pilot attempted to hold the acceleration constant while the Mach number was allowed to vary.

In the tests, continuous records were obtained of the airspeed, pressure altitude, normal acceleration, elevator angle, and elevator stick force. In addition, the angles of attack of the wing and of the horizontal tail were obtained. These latter two quantities were not measured on airplane 2 with the flap deflected  $-4.5^\circ$ . Records were also obtained of the motions of the ailerons of the two airplanes.

## RESULTS

In evaluating the results obtained, the data were first segregated into small ranges of Mach number ( $\Delta M \approx 0.02$ , except where rapid changes in the variables being studied indicated a need for a smaller range of Mach number). For each small range of Mach numbers the following items were plotted as a function of airplane normal-force coefficient,  $C_N$ :

1. Elevator angle,  $\delta_e$
2. Elevator hinge-moment coefficient parameter,  $F/q$
3. Airplane angle of attack,  $\alpha_A$
4. Tail angle of attack,  $\alpha_t$

Several typical plots are presented in figure 8 to illustrate the number of test points obtained for each curve and the degree of dispersion of the data.

From curves similar to those of figure 8 values of the various parameters were selected for values of  $C_N$  of 0.1, 0.2, and 0.3 and were plotted against Mach number. Figure 9 shows the variation with Mach number of  $\delta_e$  and  $F/q$  for values of  $C_N$  of 0.1, 0.2, and 0.3 for airplane 1 with flaps undeflected and deflected  $-6^\circ$ . Figure 10 shows the variation with Mach number of  $\alpha_A$  and  $\alpha_t$  for the same conditions.

Similar curves for airplane 2 with the flaps undeflected and deflected  $-8.7^\circ$  are shown in figures 11 and 12. The curves for the flap deflected  $-4.5^\circ$  were not included, as complete data were not available for this configuration, and the results obtained showed no appreciable change from those obtained with the flaps undeflected.

#### DISCUSSION

For a given airplane at a given altitude the steady flight value of airplane  $C_N$  varies inversely as the square of the Mach number. However, in the Mach number range in which interest is centered in the present investigation ( $M \approx 0.65$ ) the variations of  $C_N$  with Mach number for steady flight are small for wing loadings of the order of 40 pounds per square foot. For convenience it has become accepted practice in such cases to regard the changes that occur at a given value of  $C_N$  ( $C_N \approx 0.1$ ) as indicative of those that would occur in steady flight. This is the procedure used in the analysis of the data for the present investigation.

#### Airplane 1

Undeflected flaps.- The variations of elevator angle and the stick-force parameter  $F/q$  with Mach number with the flaps undeflected (fig. 9) show that at a Mach number of about 0.70 a diving tendency begins to set in, which increases until a Mach number of about 0.77 is attained. As the Mach number is increased further to the value of about 0.805 the diving tendency decreases slightly. The changes in elevator angle required for trim that characterize the diving tendency, range from  $2-3/4^\circ$  for a value of  $C_N$  of 0.1 to  $4^\circ$  for a value of  $C_N$  of 0.3, and the corresponding stick-force changes as indicated by the changes in  $F/q$  range from 11 pounds to 36 pounds, respectively.

Flaps deflected  $-6^\circ$ .- When the flaps were deflected  $-6^\circ$  a small change in elevator trim angle occurred at low Mach numbers (fig. 9). The Mach number at which the diving tendency commenced, as indicated by both the elevator angle and the stick-force parameters (fig. 9), was increased by about 0.02, and the rate of increase of the diving tendency with increasing Mach number was appreciably reduced. At Mach numbers from 0.76 to 0.78, depending on the value of airplane  $C_N$ , a reversal in the trend of the curves occurs which persists to the highest test Mach number of about 0.795. The over-all changes in elevator angle required for trim range from  $1\frac{1}{4}^\circ$  for a value of  $C_N$  of 0.1 to  $1\frac{1}{2}^\circ$  for a value of  $C_N$  of 0.3, and the corresponding stick-force changes range from 15 pounds push force to 10 pounds pull force, respectively. Comparison of these values with the values previously quoted for the airplane with the flaps undeflected shows immediately the sizable improvement in longitudinal-control characteristics effected within the test limits by deflecting the flaps upward.

It is also noteworthy that the relief of the diving tendency that occurred at the highest Mach numbers with the flaps negatively deflected was noted favorably by the pilot, but that the corresponding relief with the flaps undeflected was not apparent.

It appears from analysis of the results shown in figures 9 and 10 that on airplane 1, deflecting the flaps  $-6^\circ$  provided a sizable reduction of the diving tendency by reducing the variation with Mach number of the airplane angle of attack for a constant normal-force coefficient. This reduction in the variation of airplane angle of attack with Mach number results primarily from a favorable loss in flap effectiveness at Mach numbers above about 0.70. The reduction in flap effectiveness is indicated in figure 10 by the converging trend of the curves for the airplane angle of attack. Also, it appears that with the flaps deflected upward, important trim changes occur at the highest test Mach numbers which are greater in magnitude than corresponding changes indicated for the undeflected-flap configuration and which appear to be associated with downwash changes resulting from abrupt changes in span load distribution of the finite span wing.

#### Airplane 2

Flaps undeflected.- The variations with Mach number of the elevator angle and the stick-force parameter for flaps undeflected shown in figure 11 indicate that the diving tendency sets in at a Mach number of about 0.70 and continues to increase up to the highest test Mach number. Within the test limits, the observed changes in trim for an airplane normal-force coefficient of 0.1



are about  $2.3^\circ$  elevator angle and about 64 pounds stick force. As compared with the results obtained on airplane 1, the elevator-angle changes are approximately the same over a comparable Mach number range, while the measured stick-force changes are considerably greater. As the value of  $C_N$  is increased, the rate of change with Mach number of elevator angle and of stick-force parameter becomes progressively greater. This characteristic, coupled with large changes in trim at low values of  $C_N$ , makes it increasingly difficult to recover from high Mach number dives.

The airplane and tail angles of attack corresponding to the results for undeflected flap shown in figure 11 are presented in figure 12. These data show that the variations in tail angle of attack are reflected qualitatively by the changes in elevator angle and stick-force parameter. It appears then that the diving tendency of the airplane with flaps undeflected results primarily from the increase in the angle of attack of the airplane for a constant normal-force coefficient.

Flaps deflected  $-8.7^\circ$ . It is shown in figure 11 that deflecting the landing flaps  $-8.7^\circ$  did not appreciably improve the longitudinal-control characteristics of the airplane at high Mach numbers. The change in elevator angle required for trim for a value of  $C_N$  of 0.1 is about  $2.8^\circ$ , and the corresponding stick-force change is approximately 47 pounds. The diving tendency sets in at a slightly lower Mach number than was the case with the flaps undeflected. However, a slight improvement is noted in the rate of increase of the diving tendency with increasing Mach number. In addition, a desirable reduction in the stick-force parameter gradient  $d(F/q)/dC_N$  is obtained at high Mach numbers. Also, as contrasted with the results obtained with the landing flaps undeflected, a change in the trend of the curves at the higher test Mach numbers indicates that an upper limit for the trim changes may exist at speeds slightly higher than the highest test values.

Airplane buffeting which increased in severity with increasing Mach number and normal acceleration was experienced with airplane 2 with the flaps undeflected and deflected upward. This buffeting was more severe than the relatively slight buffeting reported for airplane 1, particularly with the flaps deflected upward, and limited the Mach numbers and normal accelerations to which the tests could be carried.

Figure 12 shows that the variation of airplane angle of attack with Mach number was essentially unchanged except above 0.75 Mach number. However, there was a definite reduction in the variation of horizontal-tail angle of attack with Mach number except at the highest test value of airplane  $C_N$ . As compared with the results

obtained on airplane 1, the reduction in the variation with Mach number of airplane angle of attack was not as marked, indicating a lesser reduction in flap effectiveness for airplane 2 at high Mach numbers. Although, for the up-flap configuration at the lower values of airplane  $C_N$ , a material improvement in the variation with Mach number of the horizontal tail angle of attack was noted (due to an inboard shift of span loading on the wing at high Mach numbers), there was no corresponding improvement in the variations of elevator angle and stick-force parameter. It appears, therefore, that for the negative-flap configuration, the diving tendencies apparently arise from a different source than they do with flaps undeflected. That is, with the flaps deflected upward the diving tendencies are probably caused by changes in the pitching-moment coefficient of the airplane without the horizontal tail, while with the flaps neutral they are due mainly to changes in angle of attack of the airplane and the corresponding increases in tail angle of attack.

These results are in decided contrast with those obtained on airplane 1 where reducing the variation of angle of attack of the airplane provided a noticeable improvement in the variation of elevator angle and stick force with Mach number.

#### CONCLUSIONS

Flight tests were conducted on two airplanes having wings of NACA 66-series and NACA 230-series sections, respectively, to determine the effect of deflecting the landing flaps upward on the high-speed longitudinal-control characteristics. From these tests the following conclusions have been drawn:

1. Upward deflection of the landing flaps had the desired primary effect of reducing the variation of horizontal-tail angle of attack, and a "secondary" effect of causing a negative increase of the pitching moment of the wing with Mach number. The over-all result was dependent on the relative magnitude of these two effects. For the airplane with a wing of NACA 230-series airfoil section the wing pitching-moment factor was sufficient to counteract almost completely a favorable change in horizontal-tail angle-of-attack variation that resulted from deflecting the flaps  $-8.7^\circ$ . For the airplane with the wing having an NACA 66-series airfoil section, however, this factor did not completely offset the reduction in horizontal-tail angle-of-attack variation so that a noticeable decrease in the diving tendency resulted from deflecting the flaps  $-6^\circ$ .

2. For both airplanes, at values of normal-force coefficient up to 0.3, deflecting the landing flaps upward reduced appreciably

the variation with Mach number of the airplane angle of attack for constant normal-force coefficient. The effect was much more pronounced in the case of the airplane with the wing having a 66-series airfoil section, indicating that a greater, favorable loss of flap effectiveness was obtained with this airplane.

3. On the airplane with the 66-series airfoil important favorable trim changes occurred at the highest test Mach numbers with the flaps deflected  $-6^\circ$  which were greater in magnitude than corresponding changes noted with the flaps undeflected and which appeared to be associated with abrupt changes in span load distribution.

Ames Aeronautical Laboratory,  
National Advisory Committee for Aeronautics,  
Moffett Field, Calif.

#### REFERENCES

1. Hood, Manley J., and Allen, H. Julian: The Problem of Longitudinal Stability and Control at High Speeds. NACA CB No. 3K18, 1943.
2. Axelson, John A.: Longitudinal Stability and Control of High-Speed Airplanes with Particular Reference to Dive Recovery. NACA RRM No. A7C24, 1947.
3. Brown, Harvey H., Rolls, L. Stewart, and Clousing, Lawrence A.: An Analysis of Longitudinal-Control Problems Encountered in Flight at Transonic Speeds with a Jet-Propelled Airplane. NACA RRM No. A7G03, 1947.

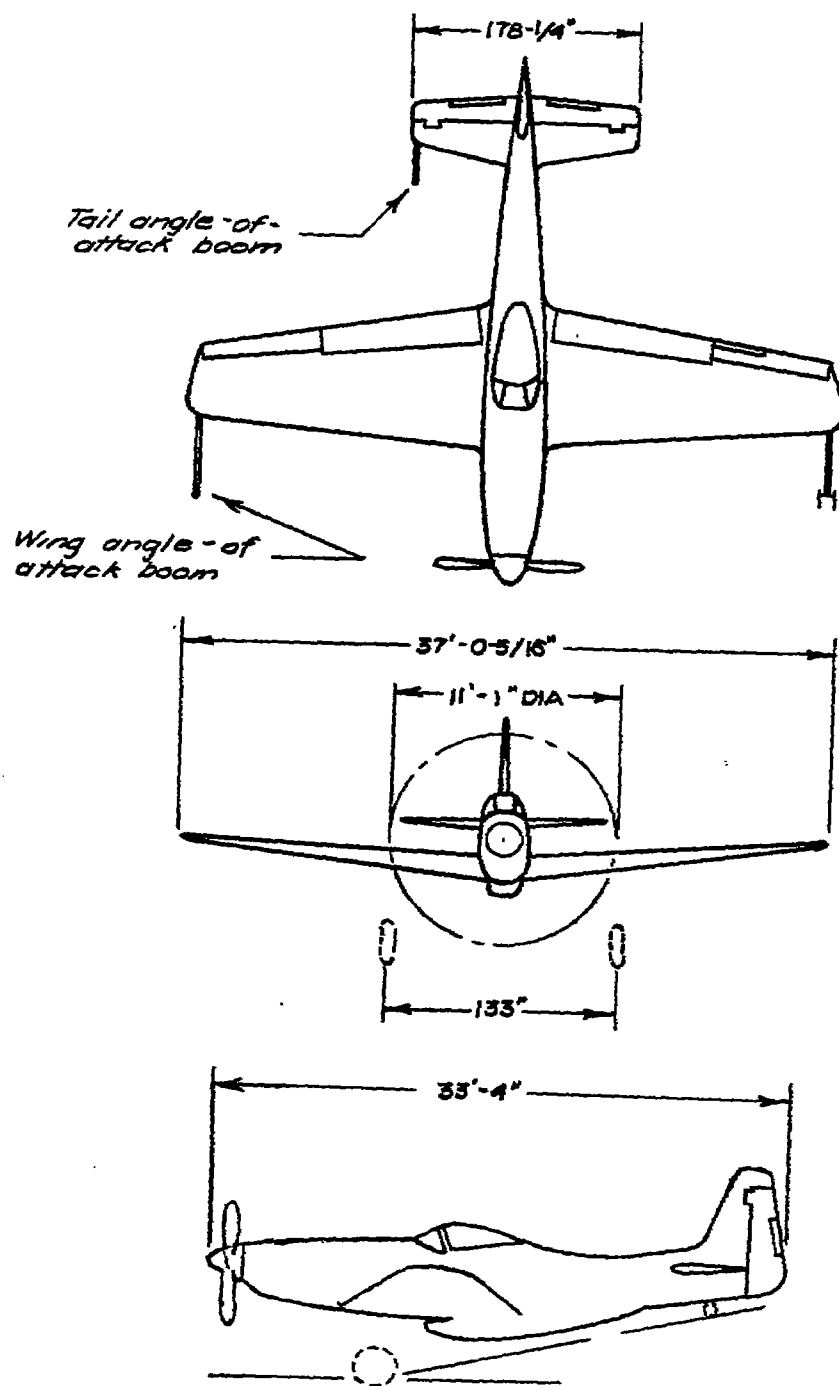

NATIONAL ADVISORY  
COMMITTEE FOR AERONAUTICS

Figure 1.-Three-view drawing of airplane 1.

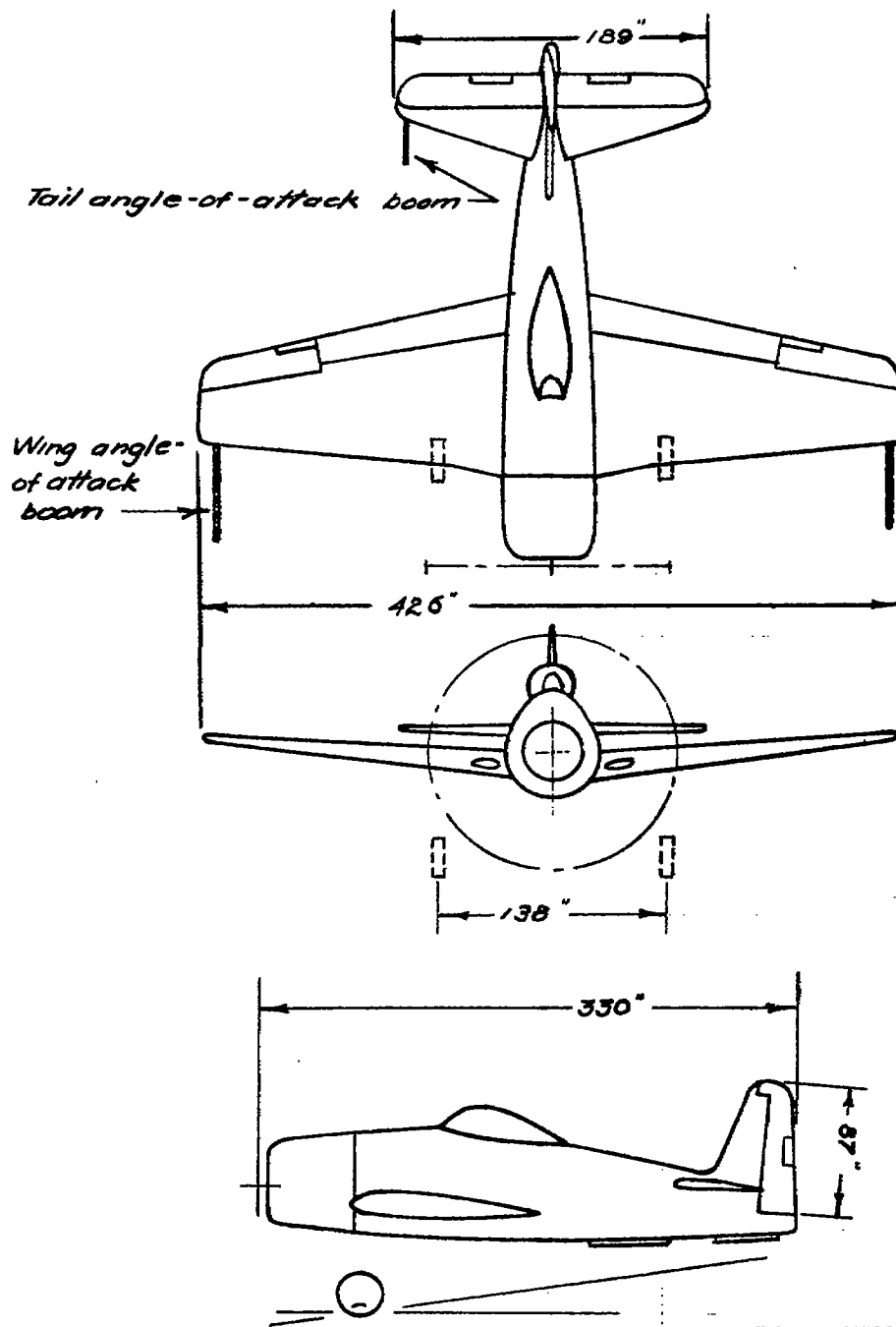

NATIONAL ADVISORY  
COMMITTEE FOR AERONAUTICS

Figure 2.- Three-view drawing of airplane 2.

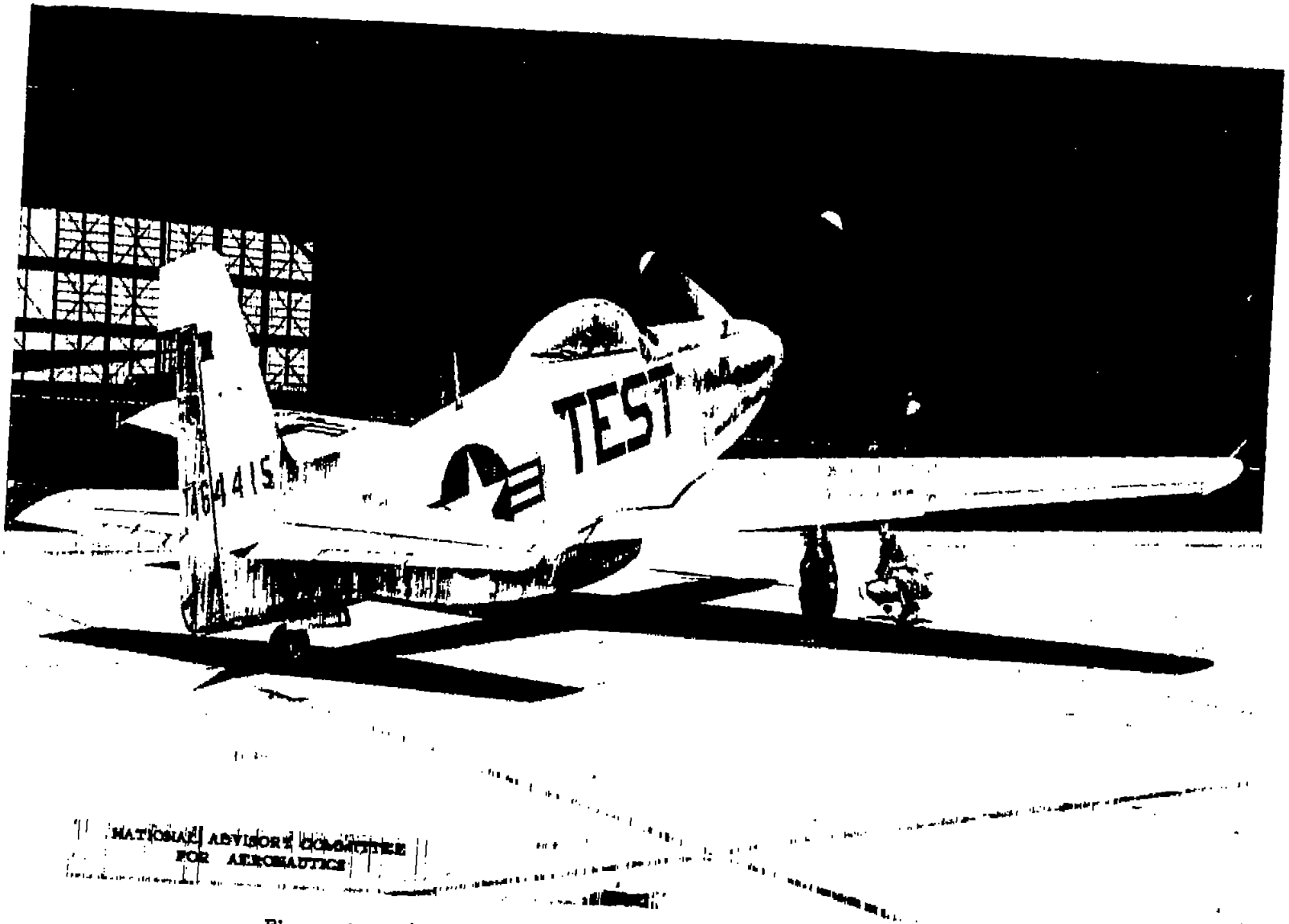

Figure 3.- Three-quarter rear view of airplane 1.

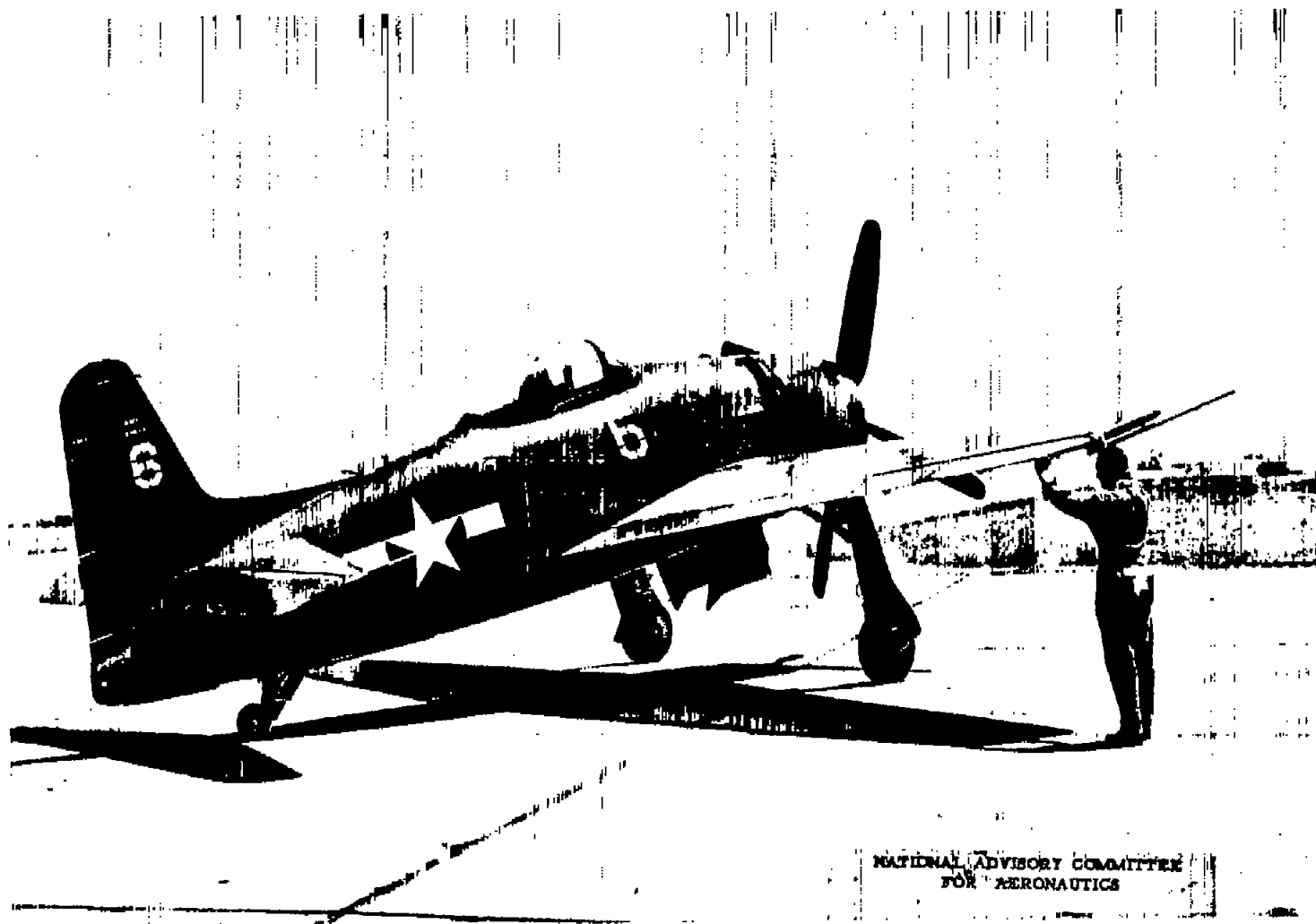
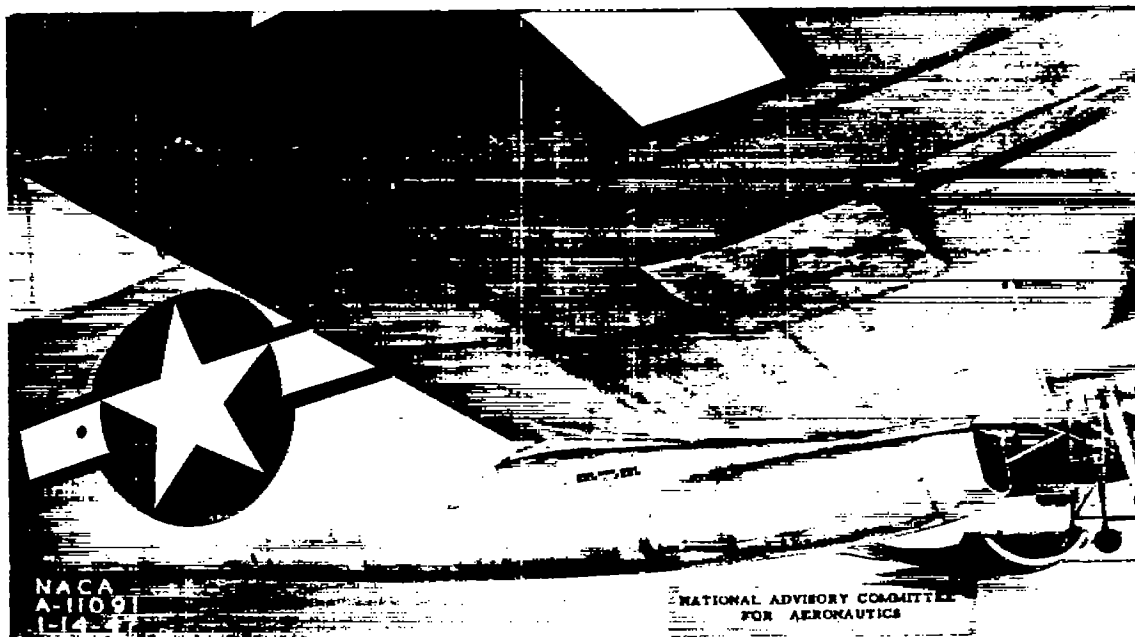

Figure 4.- Three-quarter rear view of airplane 2.



(a) Upper surface.



(b) Lower surface.

Figure 5.- Views of reflexed flaps on airplane 1.



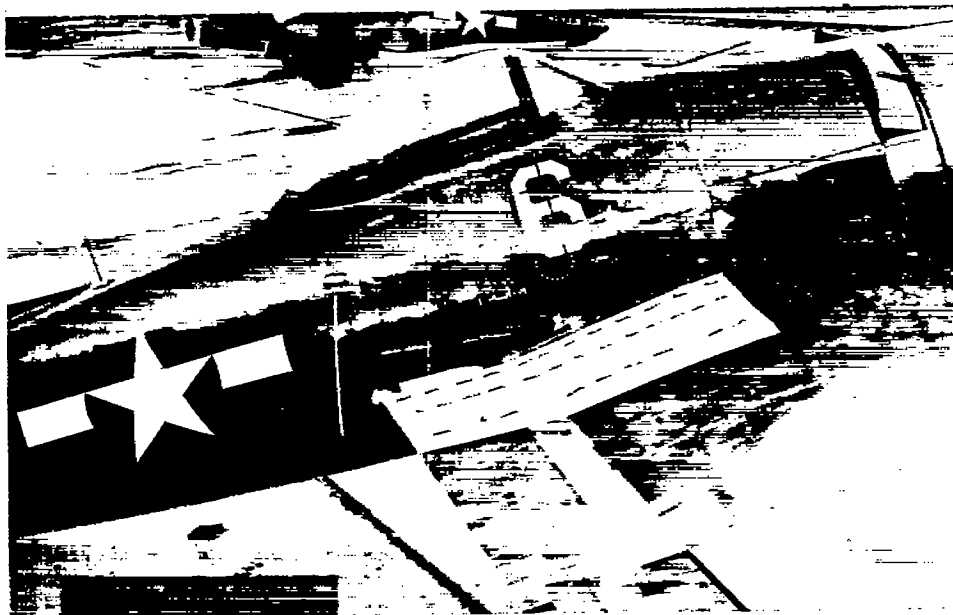

(a) Upper surface.

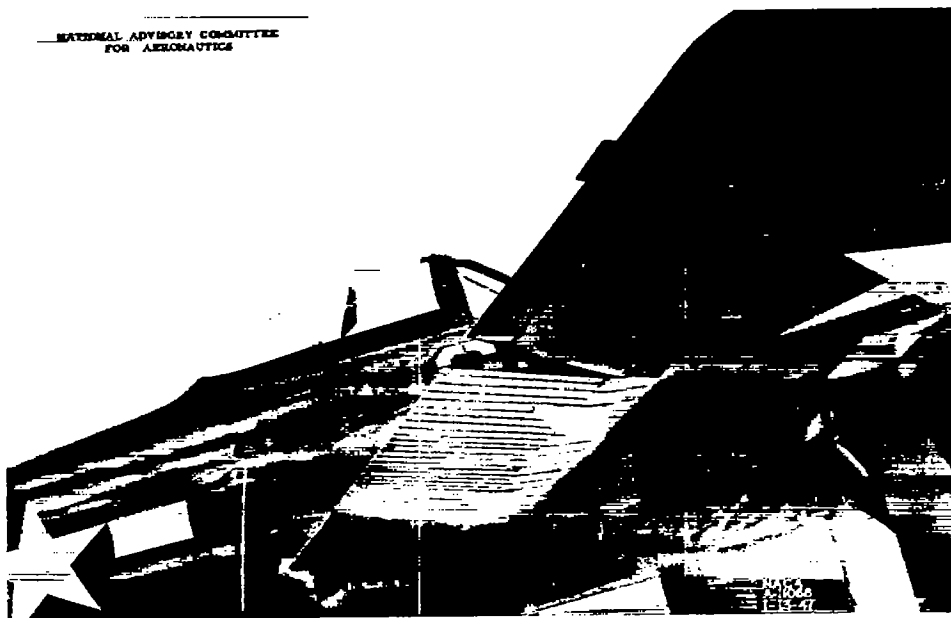

(b) Lower surface.

Figure 6.- Views of reflexed flaps on airplane 2.

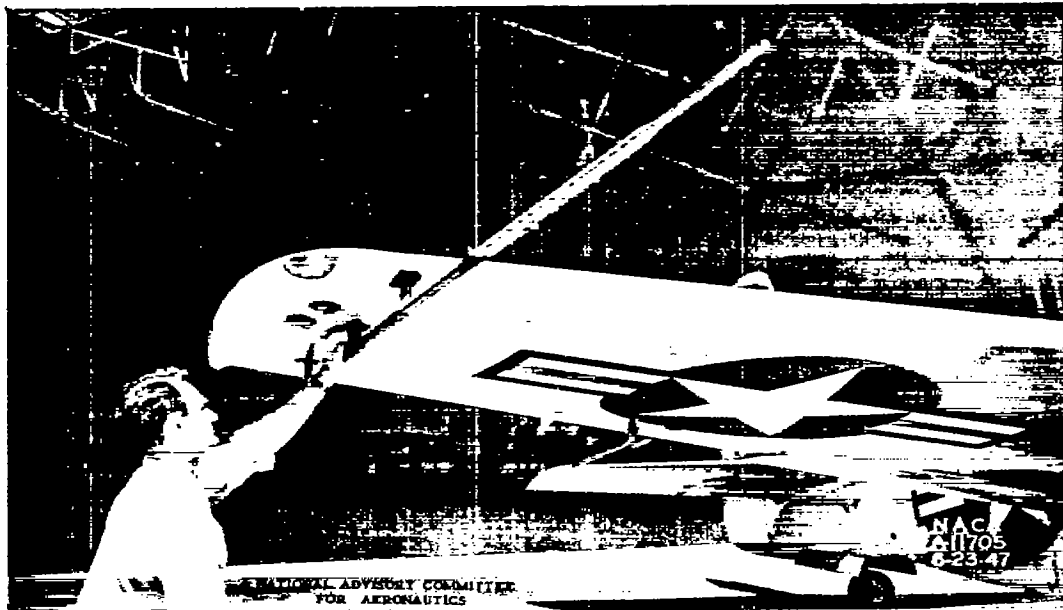

(a) Wing installation.

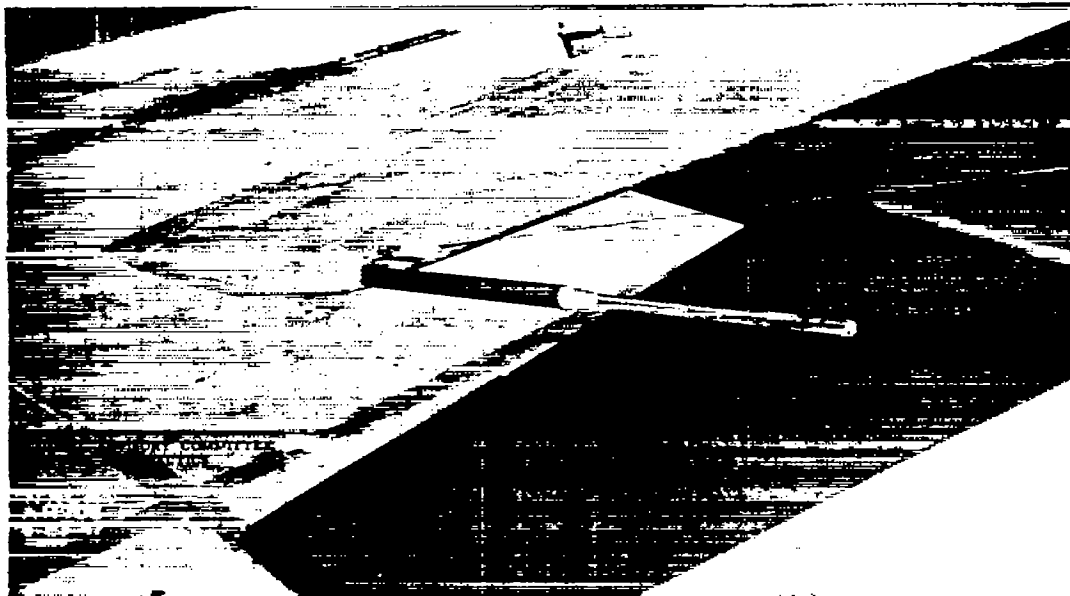

(b) Horizontal tail installation.

Figure 7.- Views of directional pitot head installations on airplane 1.

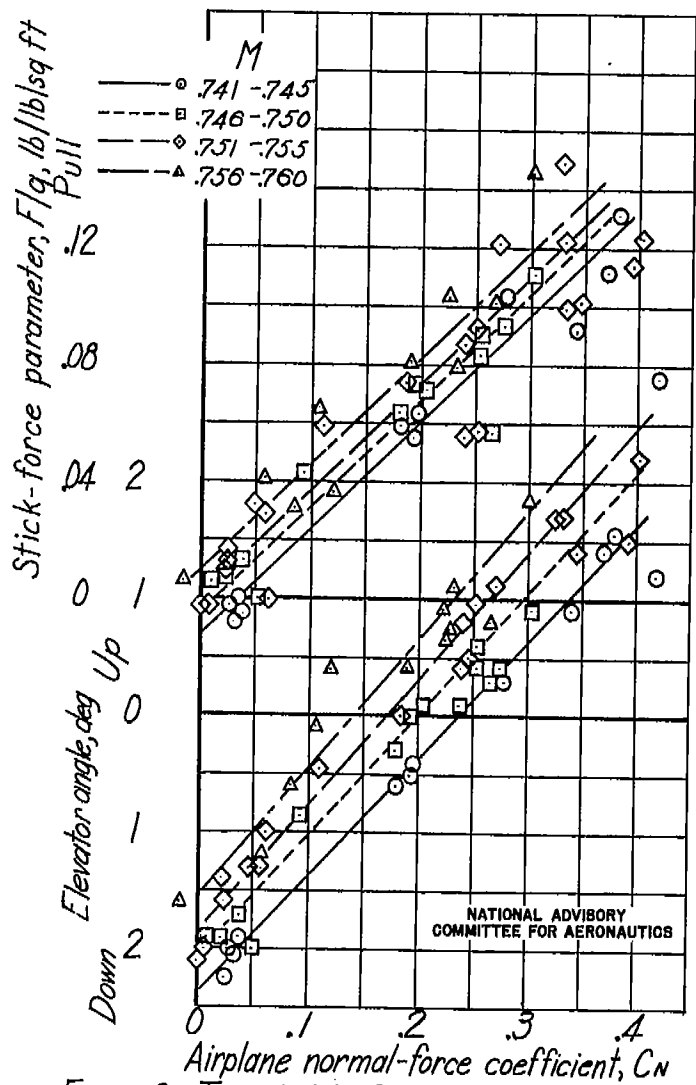
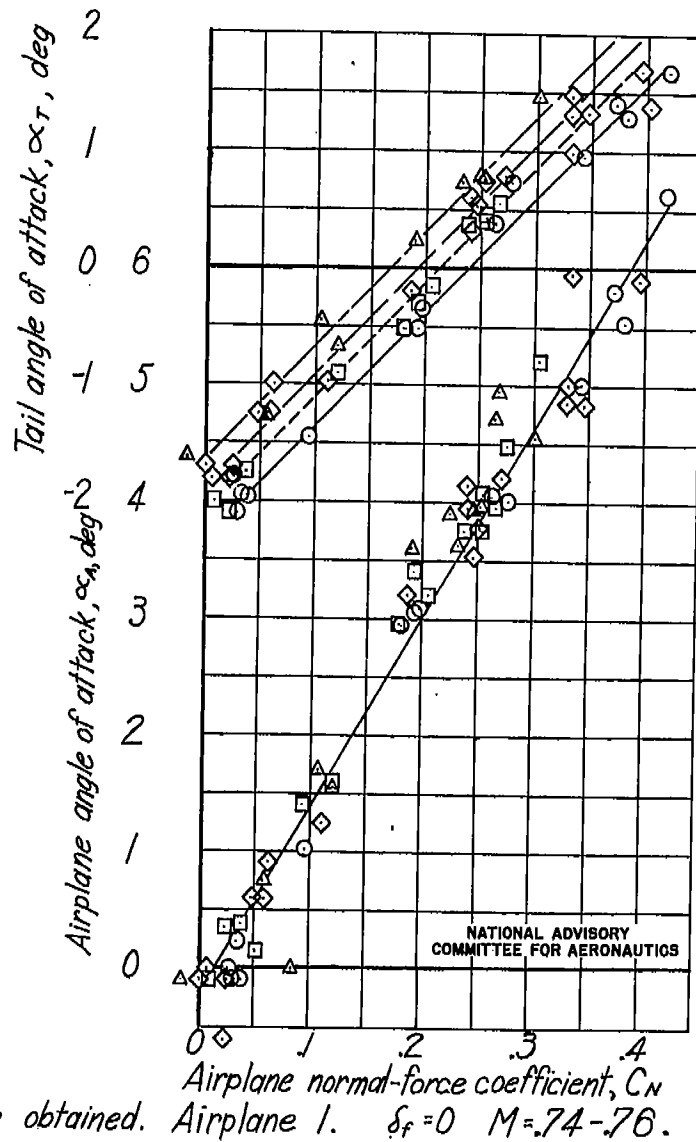
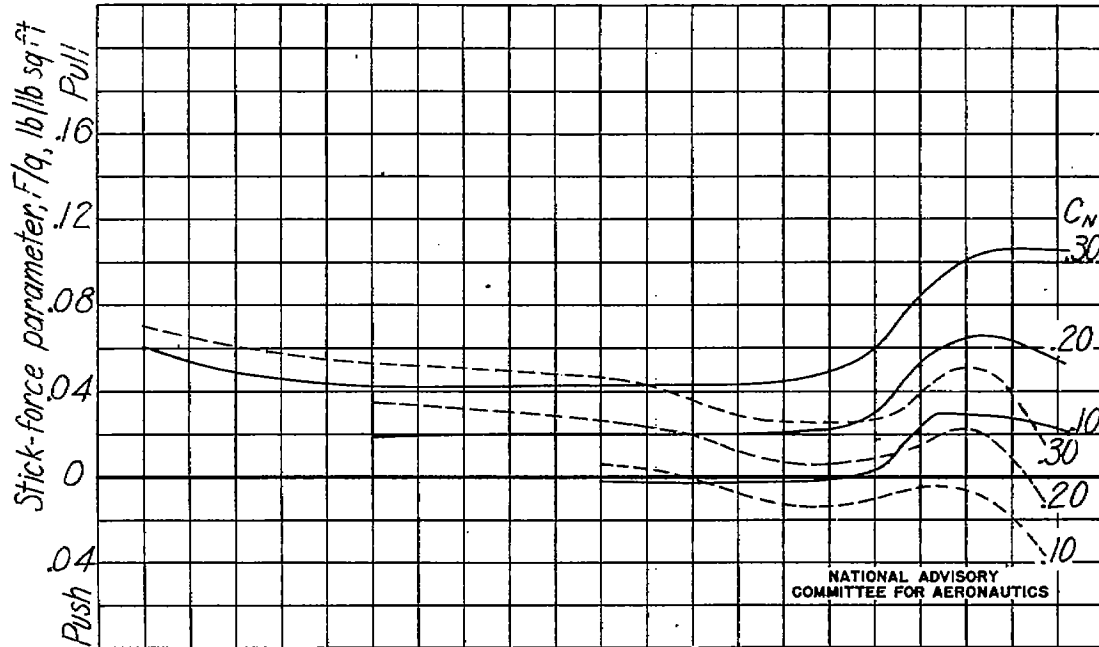

Figure 8.- Typical data from which resultant curves were obtained.



Airplane 1.  $\delta_f = 0$   $M = .74 - .76$ .



— Flap undeflected  
 - - - Flap deflected -6°

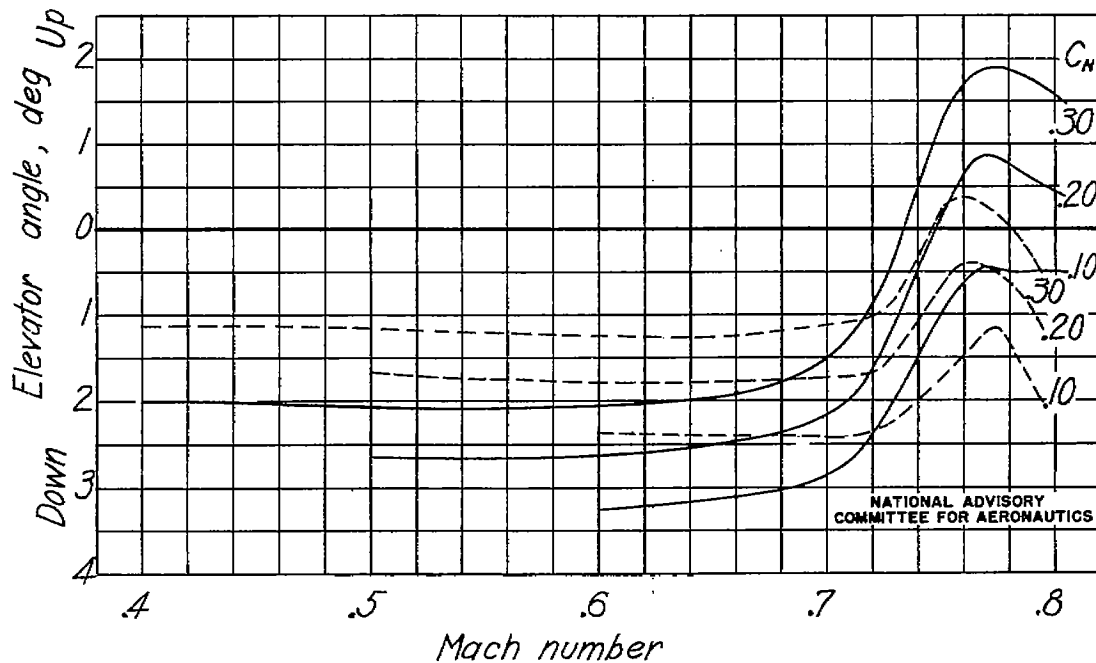

Figure 9.- Effect of negative flap deflection on the variation with Mach number of the elevator angle and the stick-force parameter,  $F/q$ , required for balance. Airplane 1.

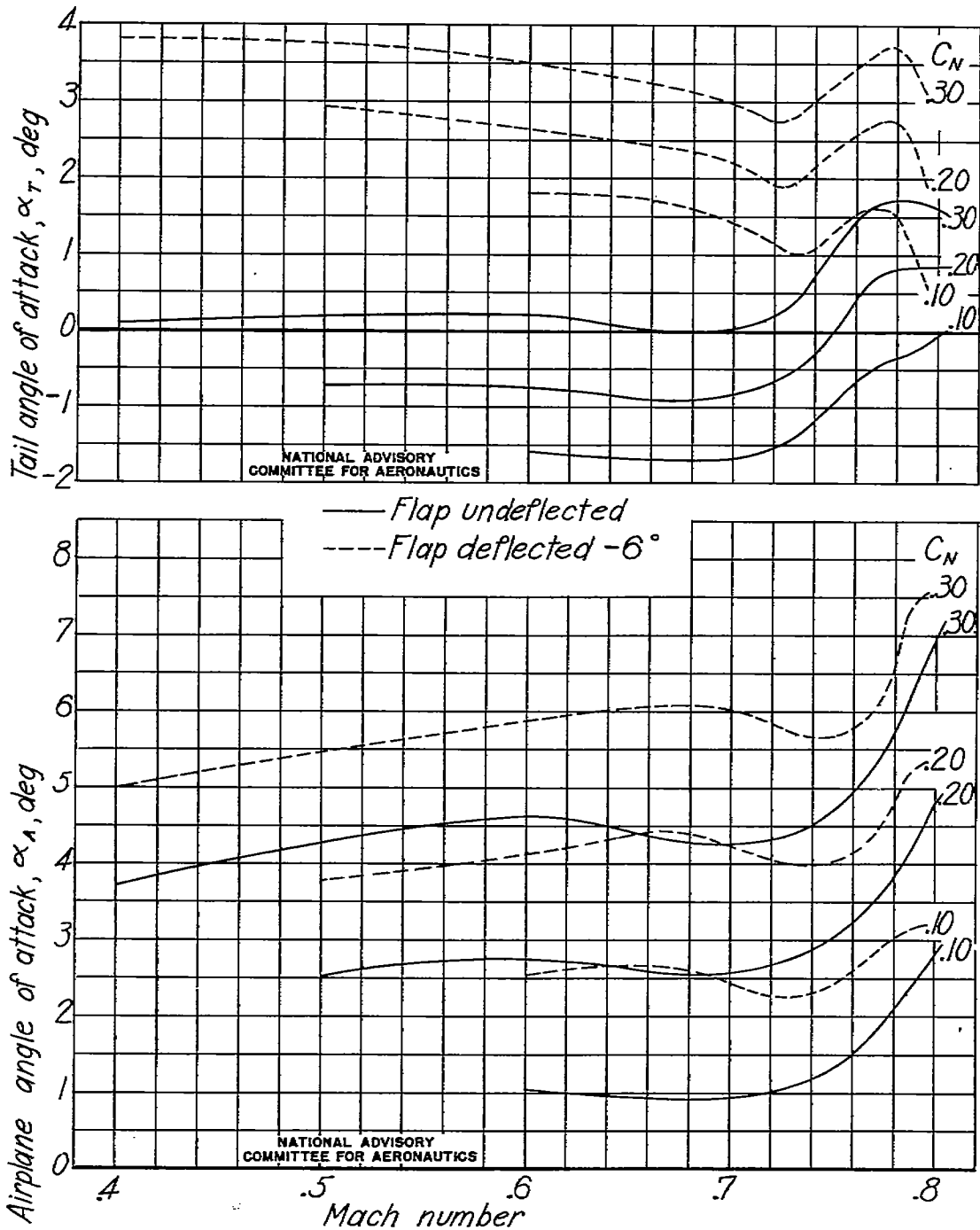

Figure 10.-Effect of negative flap deflection on the variation with Mach number of the indicated airplane and tail angle of attack. Airplane 1.

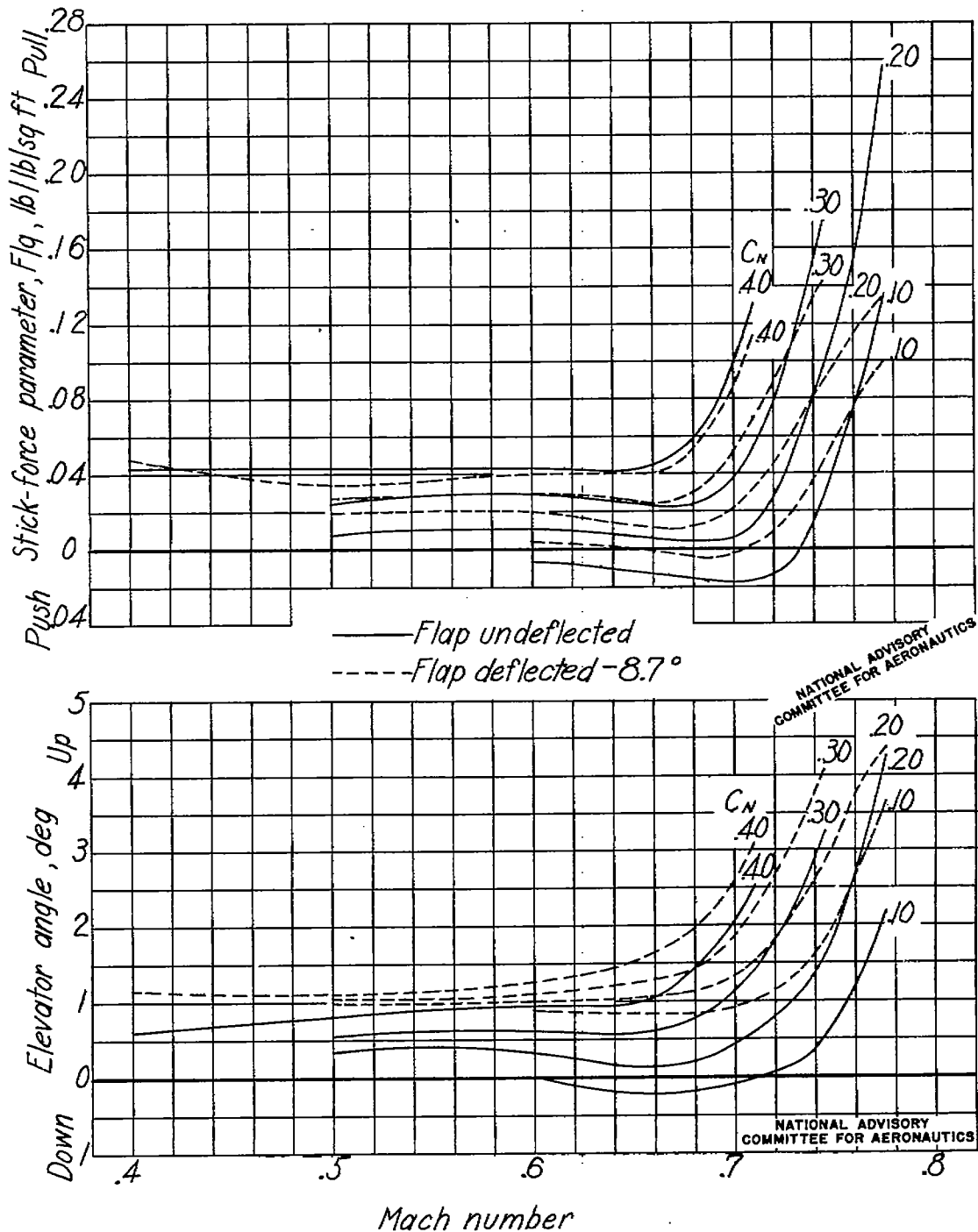

Figure 11.- Effect of negative flap deflection on the variation with Mach number of the elevator angle and the stick-force parameter,  $F/q$ , required for balance. Airplane 2.

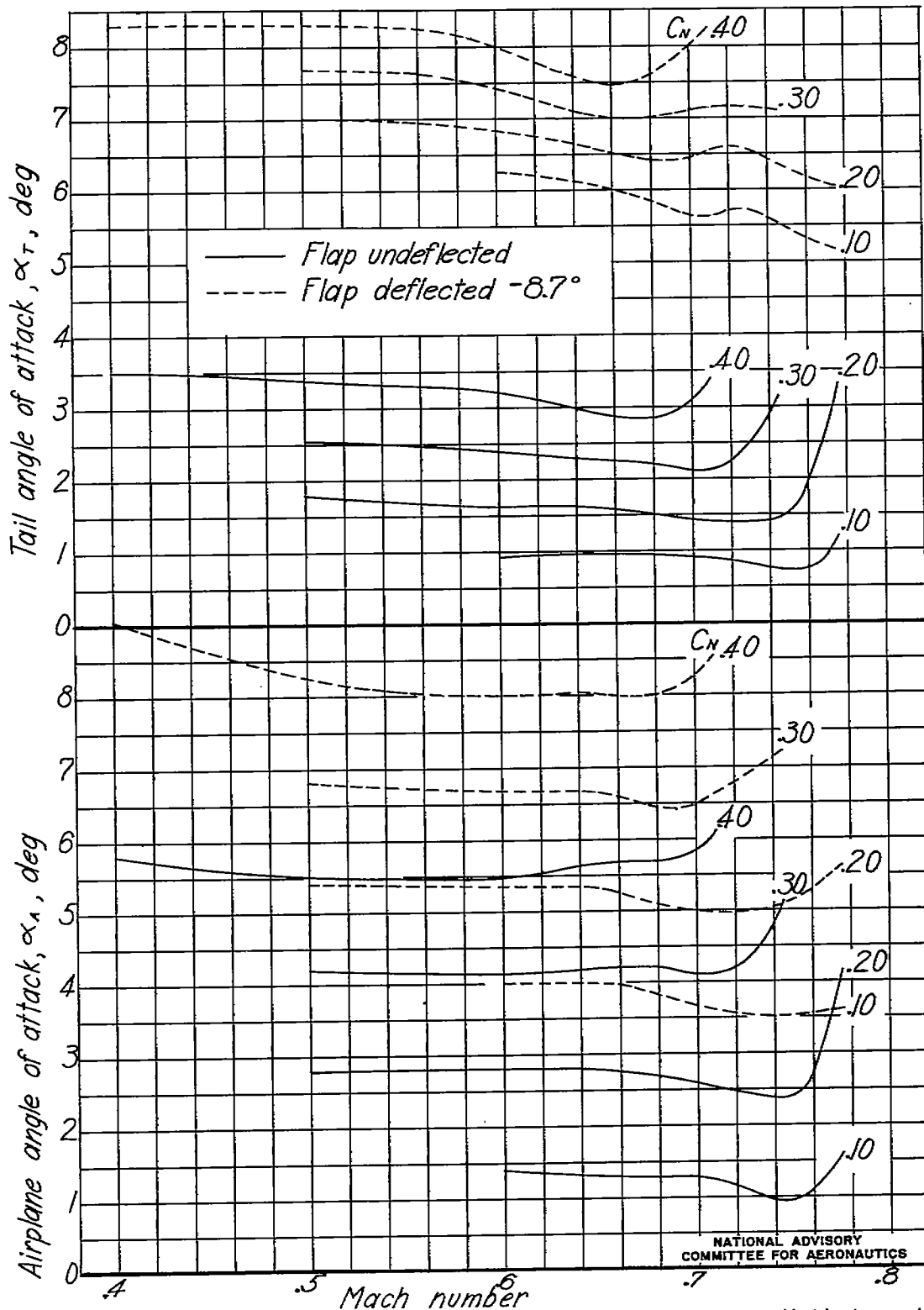

Figure 12.-Effect of negative flap deflection on the variation with Mach number of the indicated airspeed and tail angle of attack. Airplane 2.

NASA Technical Library



3 1176 01434 4379