

FEB 28 1943

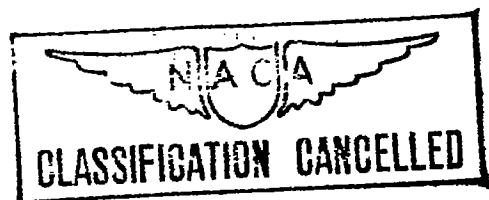

TECHNICAL NOTES

NATIONAL ADVISORY COMMITTEE FOR AERONAUTICS

No. 880

METHODS OF MEASUREMENT OF HIGH AIR VELOCITIES

BY THE HOT-WIRE METHOD

By John R. Weske
Case School of Applied Science

CLASSIFIED DOCUMENT

This document contains classified information affecting the National Defense of the United States within the meaning of the Espionage Act, USC 50:31 and 32. Its transmission or the revelation of its contents in any manner to an unauthorized person is prohibited by law. Information so classified may be imparted only to persons in the military and naval Services of the United States, appropriate civilian officers and employees of the Federal Government who have a legitimate interest therein, and to United States citizens of known loyalty and discretion who of necessity must be informed thereof.

Washington
February 1943

FILE COPY
To be returned to
the files of the Langley
Memorial Aeronautical
Laboratory.

FOR REFERENCE

NOT TO BE TAKEN FROM THIS ROOM

NATIONAL ADVISORY COMMITTEE FOR AERONAUTICS

TECHNICAL NOTE NO. 880

METHODS OF MEASUREMENT OF HIGH AIR VELOCITIES

BY THE HOT-WIRE METHOD

By John R. Weske

SUMMARY

Results are presented of investigations conducted to ascertain the feasibility of measurements of high velocities including velocities in the lower sonic range by the hot-wire method.

Investigations of strengths of hot wires at high velocities were conducted with platinum, nickel, and tungsten at approximately 200° C hot-wire temperature. The results appear to disqualify platinum for velocities approaching the sonic range, whereas nickel withstands sound velocity and tungsten may be used at supersonic velocities. This conclusion applies to standard atmospheric conditions of the air.

For measurements at high velocities, hot wires must be supported by rigid prongs to avoid breakage caused by vibration of the prongs. Tungsten wire may be soldered to the prongs with soft solder after a very thin film of platinum has been electrolytically applied.

Measurements of heating current of the hot wire for constant-temperature operation show agreement with King's relation up to a velocity of 300 feet per second. Deviations from this relation were observed as sonic velocities were approached, presumably because of the effect of impact temperatures. No numerical evaluation of this aspect was undertaken, however.

Calibration curves of measurements with a circuit adjusted for linearity of reading with velocity and of directional characteristics of hot wires adjusted for linear reading are given.

INTRODUCTION

The results which have been obtained to date of an investigation undertaken at Case School of Applied Science, under the auspices of the National Advisory Committee for Aeronautics, for the purpose of investigating the possibilities and limitations of hot-wire measurements at high velocities are given in the present report. A preliminary report on this subject, which was submitted on July 25, 1941, contained a general survey of the field. The investigation has been continued and certain techniques discussed hereinafter have been developed which it is hoped may render measurements by the hot-wire method at high velocities practicable.

Topics under consideration were listed in the preliminary report as follows: (a) measurement by the hot-wire method of high velocities up to and above the acoustic velocity; (b) effect of compressibility on hot-wire measurements; (c) effect of ambient temperature as a factor entering into the measurements; (d) hot-wire measurements in a flow in which fluctuations of velocity of high frequency and large amplitude occur; and (e) hot-wire measurements in flow in which changes of direction of high frequency occur.

In the present report are presented the results of experimental investigations of (a) the strength characteristics of hot-wires of various materials in an air stream of high velocity; (b) the variation of heating current with velocity for constant-resistance operation of the hot wire; and (c) directional characteristics of a hot wire in a circuit adjusted for linearity of reading and wind velocity.

TESTS OF HOT WIRES FOR STRENGTH IN AN

AIR STREAM OF HIGH VELOCITY

A considerable number of factors enter into the problem of the strength of hot-wires at high velocity; namely, (a) the hot-wire material, (b) diameter of the hot wire, (c) length of the hot wire, (d) diameter and length of prongs, (e) method of attachment of hot wire to the prongs, (f) rigidity of mounting of the prongs in the hot-wire

holders; (g) temperature of the hot wire, (h) tension of the hot wire, (i) turbulence of the air stream, and (j) duration of the test. In the development of a technique of investigation it was found exceedingly difficult to effect a clear separation of the influence of the various factors. For this reason an attempt has been made to obtain, by the use of hot wires of various materials, diameter, and length in combination with prongs and holders of various designs, an answer concerning the practicability of hot-wire measurements in a high-velocity air jet as far as strength properties of the wire and design of the mounting are concerned.

Equation for Strength Characteristics of Hot Wires

In order to establish a general relationship for the strength characteristic of the hot wires, it is assumed that breakage of the wire occurs as the aerodynamic drag causes the tensile stress in the wire to exceed the safe maximum limit for the metal. Let it be assumed further that the curves of the wires under load are similar, that is, that the ratio of sag s to length l is constant. The following relation may be established by the approximation of the curve by a parabola:

$$C_D \frac{\rho V^2}{2} l d \frac{l}{4s} = \sigma \frac{\pi d^2}{4}$$

where

- d diameter of wire
- l length of wire
- s maximum sag of wire
- C_D drag coefficient
- σ tensile stress

Hence

$$\sigma = \frac{1}{\pi} C_D \frac{\rho V^2}{2} \left| \frac{l}{d} \right| \left| \frac{l}{s} \right|$$

The drag coefficient varies in the range of Reynolds number ($10 < Re < 10^2$) approximately as $C_D = \frac{\text{constant}}{v \frac{l}{s}}$.

If this variation of C_D with V is neglected, wires of equal length-diameter ratio can sustain, for equal sag, the same velocity pressure. It is seen further that, neglecting variations of C_D with velocity, the strength of the hot wire is a function of the product of mass density of the air and velocity squared; that is, of the velocity pressure, and not simply of the velocity, or it follows from the equation that other factors being equal, the maximum safe velocity increases inversely as the square root of the mass density.

Apparatus

Wires.- Platinum, nickel, and tungsten were used as hot-wires in the investigation. Data of strength characteristics and electrical properties of these metals are given in table I. A table similar to table I for a large number of metals is given in reference 1. Only very thin wires from 3 to 5 mils in diameter were tested because of the limited capacity of the regulator tubes that supplied the heating current. These sizes are either currently in use or are believed to be applicable to high-velocity work.

Method of fastening hot wires to prongs.- The platinum and nickel wires were fastened to prongs by soft solder, a method which was found satisfactory. A mechanically and electrically satisfactory connection was produced in the case of tungsten wire by supporting prongs made of sewing needles, the eyes of which were ground open on one side to form a hook. The tungsten wire was then placed into this hook; the free end was wound around the prong and passed through the hook a second time. After the application of a drop of zinc chloride the wire was imbedded in soft solder which completely filled the eye. The connections were tested by exposure to a high-velocity air stream and accepted as satisfactory, as it was found from the reading of the heating current before and after this test that the electrical resistance of the solder connection had not changed during the test. When the tungsten wire was imbedded in solder without being wound around the prong, it was observed that after exposure to the air stream the wire had slackened; therefore,

this way of fastening the wire was found unsatisfactory. Prongs with hooks, as used for tungsten, produce a larger aerodynamic interference than the pointed prongs used for platinum and nickel. This drawback is offset, however, by the possibility of using longer wires because of the greater strength of tungsten.

Experimentation with a small spot-welding apparatus in which an attempt was made to weld tungsten wire to nickel supports failed to produce positive results because of the difficulty of controlling the intensity of the current. It is understood that satisfactory results with the spot welding of small wires have been obtained at LMAL.

Although satisfactory connection between tungsten wire and the supporting prongs might be produced by the needle method previously described, it was found in the investigations of the directional characteristics of such wires that the increase in the diameter of the prongs required by this method is a source of harmful interference. For this reason further investigations of the soldering of tungsten were undertaken. There appeared to be a possibility that tungsten might be soldered if a thin coat of another metal which soldered easily were electrolytically deposited upon its surface. The metal deposited would have to be corrosion proof and should exhibit characteristics similar to those of tungsten in regard to its temperature coefficient or resistance. Furthermore, it should be possible to deposit a very thin film in such a way that the resistance characteristics of the tungsten would not be greatly affected. The metal that best answers these various requirements undoubtedly is platinum.

A deposit of platinum upon thin tungsten filaments was obtained by exposing the wire for less than a minute to the action of an electrolytic bath. This period of time sufficed to produce a film of deposited platinum of such strength that it could be seen with a microscope in some places where a light metallic surface was produced in place of the dark surface of the tungsten wire. Tungsten wires of two sizes, 0.00042 and 0.00034 inch in diameter, were used for this test. With this coating of platinum, tungsten wire could be soldered without difficulty to steel supporting prongs. The soldering was done with a special tin-base solder containing 67 percent tin and with Schwerter's Superior Soldering Fluid (sold by Hammel, Riglander & Co., Inc., 209 W. 14th St., N.Y.C.).

The soldered joints thus produced are considered both electrically and mechanically equivalent to those obtained with platinum and nickel wire. Inasmuch as only short pieces of platinum-plated tungsten wire were available, accurate comparative measurements of resistance could not be made; the film of platinum appears, however, not to alter appreciably the resistance of the tungsten wire.

Nozzles:- The hot wires were tested by placing them normal to a jet of air discharging from a De Laval nozzle. A nozzle was first used that was designed for the expansion of air from a gage pressure of 90 pounds per square inch to atmospheric pressure. The results with this nozzle, however, were most erratic, partly because the air carried small solid particles and partly because of the high ratio of initial to final pressure for which it was designed. Because of this high ratio, the resulting temperature drop caused the moisture in the air to condense and form a visible fog and under certain conditions even minute ice particles. On the basis of this experience a second nozzle was designed for expansion from a gage pressure of 30 pounds per square inch to atmospheric pressure. Previous to expansion in this nozzle, the pressure of the air was reduced from tank pressure by a throttling process. No trouble from moisture was experienced with this nozzle. Breakage from impingement of solid particles upon the wire was reduced by a large chamber immediately ahead of the nozzle in which screens were placed to arrest these particles.

The nozzle was calibrated by an impact tube placed close to the outlet of the nozzle from which a curve of impact pressure against pressure difference across the nozzle was obtained. Exploratory measurements of the temperature of the air discharged from the nozzle were made by a thermometer held in the air stream. These measurements proved most unreliable and in subsequent work no attempt was made to determine the temperature in a jet of small diameter.

Tests and Results

The hot wire mounted on a pair of prongs was placed into the circuit of a hot-wire instrument and a heating current, by which the temperature of the wire was raised to a desired value, was applied. The characteristics of

the hot-wire instrument were such that thereafter the resistance and therefore also the temperature of the hot wire were automatically kept constant at the value determined by the initial setting, irrespective of the velocity past the wire. Constancy of the resistance, and the temperature, could be checked at any time during the test by a galvanometer. A further check through correlation of the measurements of heating currents of various velocities by means of King's equation will be discussed later.

The tests ordinarily were of 2-minute duration and, during this time, the pressure across the orifice was increased stepwise up to the point at which breakage occurred. The duration of the test was limited by the capacity of the pressure tank and of the compressor. If no breakage occurred, the test was repeated when the tank pressure was reestablished. The results are presented in table II.

Platinum may be used for relatively low velocities only as shown in table II. Nickel is regarded as a more satisfactory material because it exhibits satisfactory strength characteristics which make possible its use for velocities up to and including the velocity of sound. It may readily be soldered to supporting prongs. The high tensile strength of tungsten renders it desirable for measurements at sonic velocities; it is satisfactory, however, only if a connection to the prongs is achieved which is both mechanically and electrically reliable, such as has been obtained through application of a thin electrolytically deposited coat of platinum.

For a hot wire of a given material and diameter the maximum permissible velocity pressure is proportional to the length-diameter ratio. Satisfactory results were obtained with hot wires of length equal to 250 times the diameter. For this length the end effect due to thermal conduction may be neglected. (See reference 2.)

Table II shows that the rigidity of the prongs has a pronounced effect upon decreasing the strength of the wire. This effect of the rigidity of the prongs was investigated as follows: Two three-prong holders were tested, one with slim prongs 0.018 inch in diameter and the other with stiff prongs 0.032 inch in diameter. These prongs were spaced to permit the mounting of two wires, one twice as long as the other, which were connected in series. They were then placed into the air stream and exposed to a gradually increasing velocity until the current was interrupted. Inspection of the wires following

the interruption of the circuit showed that in the majority of cases for the holder with slim prongs both wires were broken, whereas only the longer one was destroyed in the case of the stiff prongs. Simultaneous breakage of both wires was attributed to vibration of the prongs. As seen from table II, these vibrations occur at a decreasing velocity pressure as the prongs extend across the air stream and at an increasing velocity pressure as the prongs are placed parallel to the air stream. It is concluded, therefore, that prongs should be as strong as permissible without causing undue aerodynamic interference. The most satisfactory performance was obtained when the pointed ends of No. 4 darning needles were used to support the wire.

On the basis of the observations of strength and rigidity of prongs, two holders were developed, one with prongs for attaching nickel wire, the other for unplated tungsten wire. These holders are shown in figure 1.

HOT-WIRE MEASUREMENTS AT HIGH VELOCITIES

Constant-Resistance Operation of the Hot Wire

The hot-wire measurements of high velocities taken for the experimental investigation were obtained under particular conditions of operation, namely, for constant-resistance operation of the hot wire. Since the resistance is a function of only temperature, constant-resistance operation is at the same time constant-temperature operation. This method is believed to offer a number of advantages.

If considerations of measurements of high-frequency fluctuation are disregarded, these advantages are: relatively small variations with change of wind velocity of the physical quantities affecting hot-wire measurements such as specific heat, conductivity, and mass density in the film of air surrounding the wire. Furthermore, constant-resistance operation leads to a larger variation of the measured electrical quantity, in this case the heating current, with velocity than would be obtainable with constant-current operation. This increased variation in current with velocity should render the measurements more accurate. It appears reasonable that, with constant-temperature operation, measurements could

be obtained at a relatively low hot-wire temperature, a condition which naturally is desirable when high strength of the wire is required. In practical operation constant-temperature operation was found to reduce the danger of accidentally burning out the hot wire.

Constant-resistance operation of the hot wire was effected through the circuit shown in figure 2. The particular circuit shown has the advantage of requiring a minimum number of batteries. Because the measurement of only mean velocities is considered in the present investigation, the alternating-current impulses were short-circuited by condensers, which were connected in the circuit but are not shown in figure 2. This measure considerably simplified the adjustment of the circuit.

Applicability of King's Equation

A relation between the heating current required for a hot wire and the wind velocity and certain other quantities entering into measurement by the hot-wire method has been derived by King in reference 3 from the condition that the heat supplied to the wire must equal the heat dissipated by the air stream. This equation may be stated (reference 4) as follows:

$$i^2 R = 4.2 K (T - T_0) \left(1 + \sqrt{\frac{2\pi\rho c_p Vd}{K}} \right)$$

where

- i heating current, amperes
- R resistance of the wire, ohms
- T temperature of the hot wire, °C
- T₀ temperature of the ambient air, °C
- K thermal conductivity, calories per centimeter per °C per second
- ρ mass density of air, grams per cubic centimeter
- c_p specific heat at constant pressure, calories per gram per °C

V velocity of air, centimeters per second

d diameter of the wire, centimeters

For air, Marks Handbook in reference 5 gives the following equation for K in Btu per foot per $^{\circ}\text{F}$ per hour:

$$K = 0.0129 \left[\frac{717}{T_0 + 225} \right] \left(\frac{T_0}{492} \right)^{3/2}$$

where T_0 is the absolute temperature of the air in $^{\circ}\text{F}$. The equation is valid from -312°F to $+212^{\circ}\text{F}$ and may be converted into cgs units by dividing the value of K in engineering units by 241.9.

The first quantity on the right-hand side of King's equation represents the heat dissipated by conduction and induced convection and the second quantity the heat dissipated by forced convection. Radiation losses are disregarded. The equation is applicable only above a certain low limit of velocity past the wire which, for standard atmospheric conditions, is defined by a value of Reynolds number, based upon wire diameter, of 0.108. A relation corresponding to equation (1) has been derived for velocities below this limit which, however, has no significance for the field of application under discussion.

For zero wind velocity the equation reduces to

$$i_0^2 R = 4.2 K (T - T_0) \quad (2)$$

where i_0 is the heating current at zero wind velocity. The following conditions must be considered when equation (2) is used for numerical calculations. The value of the thermal conductivity to be used in the equation is that of the film of air surrounding the wire, which is a function of the film temperature. The effective value of the film temperature is not known. It has been suggested that the conductivity corresponding to the arithmetic mean temperature of the wire and the ambient air temperature may be used.

It should be noted, furthermore, that at high velocities the temperature rise due to compression resulting from impact of the air upon the wire must be considered and, if necessary, allowance for it must be made in the choice of T_0 .

Because of these uncertainties calculations of hot-wire temperatures by equation (2) can lead to only approximate values. At velocity approaching the sonic range, the impact temperature affects the heat dissipated from the wire by conduction and induced convection given by the first term on the right-hand side of equation (1). The effect of the impact temperature also enters the relation between wind velocity and heat current given by the second term on the right-hand side of equation (1). It is seen that the relation between heating current i and velocity V for a given current i_0 is uniquely defined only if the resistance is constant and if both the temperature and the mass density of the air are constant. For this reason velocity measurements by the hot-wire method are conclusive only if variations of temperature and mass density remain within limits established by the stipulated accuracy of the results.

Experimental Check

Measurements were made to obtain an experimental check of the conformity of the method of measurement chosen with King's equation at high velocities. The results are shown in figures 3 and 4. A number of test runs were conducted with a nickel wire 0.0005 inch in diameter and 1/8 inch long for various initial heating currents i_0 and for velocities from 0 to approximately 300 feet per second. The measurements for two runs obtained in connection with the tests for the strengths of the hot wires in the high-velocity jet are also shown in figure 4. The deviation from King's relation of these measurements is attributed to variations of effective impact temperature of the air with velocity. No attempt was made to evaluate these results further because this temperature was not known.

DIRECTIONAL CHARACTERISTICS IN A CIRCUIT
ADJUSTED FOR LINEARITY

Hot-Wire Instrument with Linear Characteristic

It has been shown, in the paragraph dealing with the variation of heating current with wind velocity for constant-resistance operation, that the relation between heating current and wind velocity in which the velocity appears in the fourth root according to King's equation is maintained within the range of velocities investigated. It is seen that in accordance with the nature of the fourth-root relation at high velocities, the accuracy of velocity determination from the measured heating current becomes very low. Leaving out of consideration for the moment certain aspects pertaining to the measurement of fluctuating flow, this decrease in accuracy of reading made it desirable to establish a linear relationship between the reading of the hot-wire instrument and the velocity. This relationship was established (reference 6) through the installation of a nonlinear amplifier stage, the exponent of which could be adjusted to be inversely proportional to the exponent relating heating current to wind velocity. This amplifier stage, shown on the wiring diagram (fig. 2), consists of T_3 and its immediate external circuit including battery B_7 and meter M_2 . A calibration curve of measurements obtained with the hot-wire circuit including a linearizing stage is shown in figure 5.

If the variation of heating current with wind velocity is known, for instance, through a curve such as is shown in figure 5, it is possible to adjust the linearizing stage for the desired exponent by a simple electrical testing procedure which does not require the use of aerodynamic equipment, such as an air stream. The procedure is as follows: After the instrument is adjusted for a given heating current at zero wind velocity i_0 , currents are impressed upon the bridge of various strengths $(i - i_0)$ and of voltage opposite to that of the heating current, as indicated by the minus sign. The cathode bias of the linearizing stage is then adjusted to obtain readings that are proportional to the velocities corresponding to the values of $(i - i_0)$ chosen. A satisfactory

calibration curve can be obtained by this out-and-try method using from four to six values of $(i - i_0)$ covering the desired range of velocities. A check of this calibration can be made at any time between tests by impressing upon the bridge a negative heating current, $-(i - i_0)$ corresponding to the maximum velocity and, if necessary, adjusting the bridge balance and the amplifier.

Calibration of the Directional Characteristics of a Hot Wire Adjusted for Linear Instrument Characteristic

Calibrations of the directional characteristics (reference 7) were undertaken for two hot wires, namely, nickel wire 0.0005 inch in diameter and 1/8 inch long and nickel wire of the same diameter and 7/32 inch long. The short wire was tested in a stream of 3/4-inch diameter, the long wire in a stream of 6-inch diameter. In both curves the instrument operating on the basis of constant resistance of the hot wire was adjusted for linearity between reading and wind velocity. Calibration curves for linearity are given in figure 5 for the short wire and in figure 6, for the long wire. Test results showing the directional characteristics are given in figure 7 for the short and long wires. A sin curve is also plotted into the graph for comparison. These curves indicate that within the range of velocities from 50 feet per second to 300 feet per second, the change of reading with angle is quite pronounced, especially for angles of incidence of approximately 45° ; it is suggested, therefore, that these characteristics might possibly form the basis of directional measurements by the use of two properly oriented wires without manual adjustment in the determination of the direction.

It will be seen that the directional characteristics of the long wire show much less spread of test points with velocity for a given angle than the short wire. It was found that the variations of readings may be attributed largely to the drifting of the balance of the hot-wire instrument which, for the short wire is more critical than for the long wire. Other effects, such as interference with the flow past the hot wire caused by the prongs, did not show up clearly. Considerable trouble was caused by the accumulation of lint on the wire, which

produced fluctuations and faulty readings. In the second test (fig. 7(b)) greater care was taken than in the first test to maintain balance of the bridge and to keep the wire free from dust.

CONCLUSIONS

Tests of hot wires of platinum, nickel, and tungsten of various diameters and lengths in combination with prongs and holders of various designs indicate the following conclusions:

1. For measurements at high velocities, hot wires must be supported by rigid prongs to avoid breakage caused by vibration of the prongs. Experimentation with various types of connection between hot wire and prongs indicate that, in high-velocity work, a mechanically satisfactory connection is as difficult to obtain as a connection that has a low electrical resistance which remains constant during the life of the hot wire. Satisfactory results can be secured with steel prongs, however, by the use of soft solder for platinum and nickel and by the use of soft solder with tungsten on which a thin film of platinum has been electrolytically deposited.
2. Platinum may be used for only low velocities, nickel may be used for velocities up to and including the velocity of sound, and tungsten may be used at supersonic velocities.
3. The general relationship established by King's equation for constant-resistance operation of the wire and constant pressure and temperature of undisturbed flow may be assumed to hold for velocities up to 300 feet per second. Deviations from King's relation, which were observed as sonic velocities were approached, were assumed to result from impact temperatures.
4. Decrease in accuracy at high velocities resulting from the fourth-root relationship between heating current and velocity in King's equation for constant resistance operation, made it desirable to establish proportionality between the reading of the hot wire instrument and the velocity.

REFERENCES

1. MacGregor-Morris, J. T.: The Electrical Measurement of Wind Velocity. *Engineering*, vol. 94, no. 26, Dec. 27, 1912, pp. 892-894.
2. Harper, D. R., 3d, and Brown, W. B.: Mathematical Equations for Heat Conduction in the Fins of Air-Cooled Engines. Rep. No. 158, NACA, 1923.
3. King, Louis Vessot: On the Convection of Heat from Small Cylinders in a Stream of Fluid, Determination of the Convection Constants of Small Platinum Wires with Applications to Hot-Wire Anemometry. *Phil. Trans. Roy. Soc. (London)*, ser. A, vol. 214, 1914, pp. 373-432.
4. Dryden, H. L., and Keuthe, A. M.: The Measurement of Fluctuations of Air Speed by the Hot-Wire Anemometer. Rep. No. 320, NACA, 1929.
5. Marks, Lionel S.: *Mechanical Engineers' Handbook*. McGraw-Hill Book Co., Inc., 4th ed., 1941, p. 395.
6. Huguenard, Magnan, and Planiol, A.: *Aérodynamique - Sur un Anémomètre à Fil Chaud à Compensation*. *Comptes Rendus*, vol. 176, no. 5, Jan. 29, 1923, pp. 287-289.
7. Burgers, J. M.: Abkühlung eines Fadens, welcher nicht senkrecht von der Strömung getroffen wird Anwendung zur Bestimmung der Strömungsrichtung. Vol. IV, *Hitzdrahtmessungen*, sec. 6 of *Handb. Exp. Phys. Akad. verlagsgesellschaft (Leipzig)* 1931, fig. 5, p. 657.

TABLE I

PHYSICAL PROPERTIES OF METALS USED FOR HOT WIRES

[Values taken from reference 8]

Metal	Melting point (°C)	Electrical resistivity (microhm-cm)	Temperature coefficient of resistivity (ohm-cm/°C)	Tensile strength (lb/sq in.)
Platinum	1773.5	^a 9.63	^b 0.003	53,000
Nickel	1440	^b 7.8	^c .00537	70,000 to 85,000
Tungsten	3382	^b 5.5	^d .0047	215,000

^aAt 0° C.^bAt 20° C.^cFrom 20° C to 100° C.^dFrom 0° C to 100° C.

TABLE II

RESULTS OF TEST OF HEATED HOT WIRES IN A HIGH-VELOCITY AIR JET

Number of tests	Diameter of wire		Length of wire		Diameter of prongs (in.)	Free length of prongs (in.)	Position of prongs with respect to air stream	Heating current at zero air velocity (ma)	Approximate temperature of wire (°C)	Average velocity at instant of breaking (lb/sq in.)	Average velocity at instant of breaking at standard air conditions (fps)	Remarks
	(mils)	(microns)	(in.)	(cm)								
Platinum												
2	0.2	5.1	$\frac{1}{8}$	0.318	0.032	$\frac{3}{8}$	Parallel	30	199	3.8	650	
			$\frac{1}{16}$.159						7.5	860	
3	.3	7.6	$\frac{1}{8}$.318	.018	$\frac{3}{8}$	Parallel	44	195	6.5	825	
			$\frac{1}{16}$.159						8.5	920	
			$\frac{3}{32}$.24						5.4	760	
			$\frac{9}{64}$.358						5.4	780	
												(1)
												(1)
Nickel												
2	0.5	12.7	$\frac{1}{8}$	0.318	0.032	$\frac{3}{8}$	Parallel	73	192	11.5	1085	
4			$\frac{1}{16}$.159						>20	>1400	(2)
3			Perpendicular	>20						>1400	(2,3)	
Tungsten												
8	0.34	8.8	$\frac{3}{16}$	0.475	0.036	$\frac{3}{8}$	Parallel	50	141	>20	>1400	(2)
3							Perpendicular			25	>1400	(4)
1	.42	10.7	$\frac{3}{16}$	0.475	0.036	$\frac{3}{8}$	Parallel	65	180	>20	1600	(2)
1							Perpendicular			>20	>1400	(3)

¹ Both wires tested simultaneously on a three-prong holder. Both wires broke simultaneously, presumably due to vibration of prongs.

² No breakages observed.

³ Prolonged test.

⁴ Occasional breakages, presumably due to vibration of prongs.

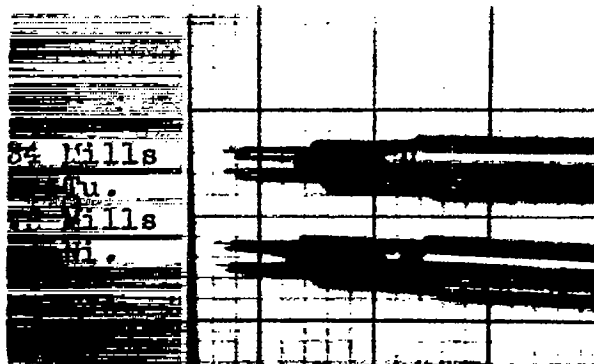

Figure 1.- Hot-wire holders for nickle and tungsten wire.

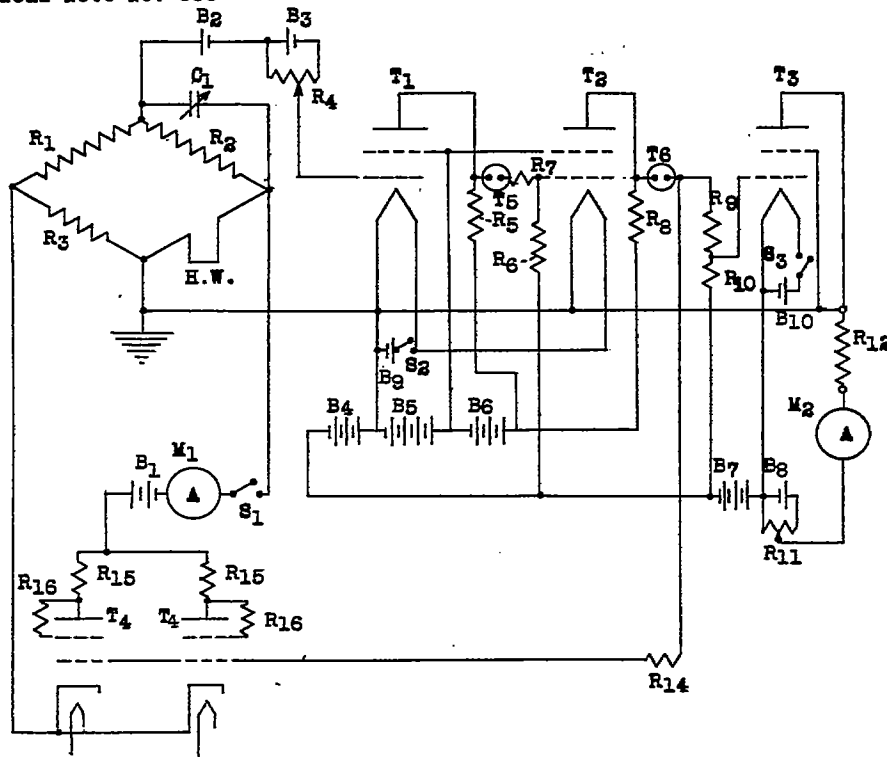

Figure 2.- Hot-wire circuit.

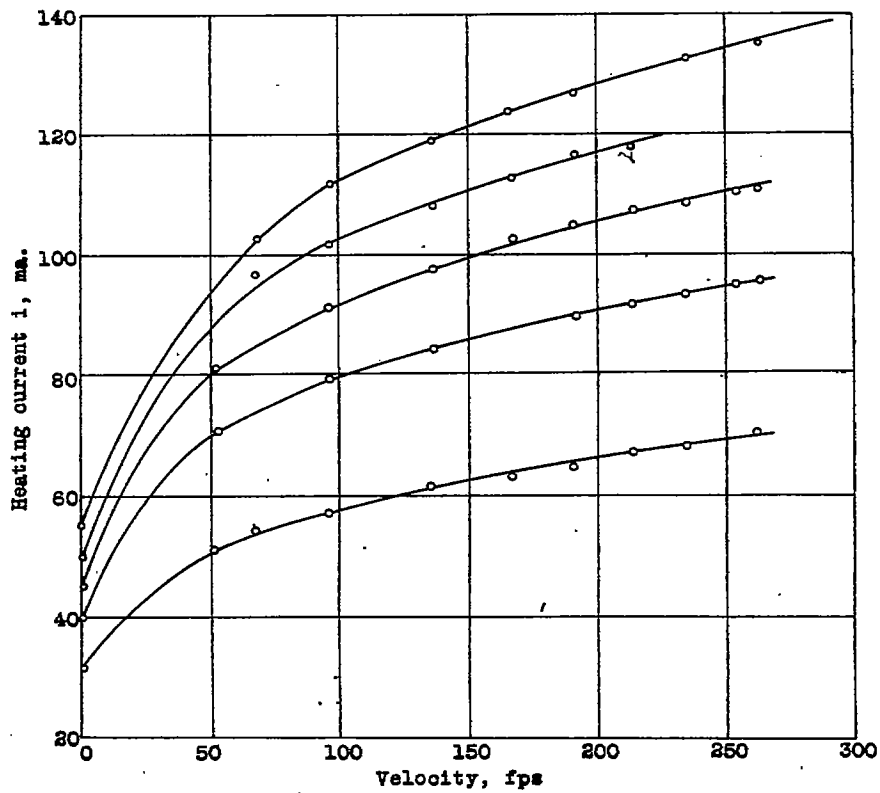

Figure 3.- Heating current of a hot wire at constant-resistance operation.

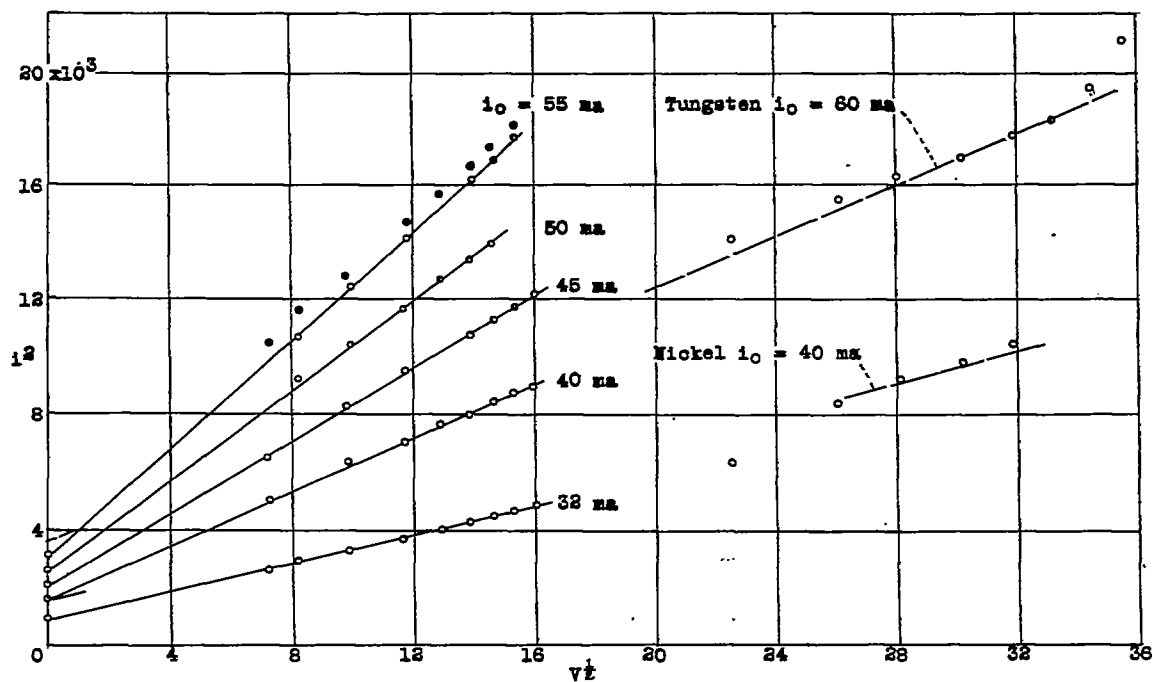

Figure 4.- Heating current for constant-resistance operation plotted for check of conformity with King's relation.

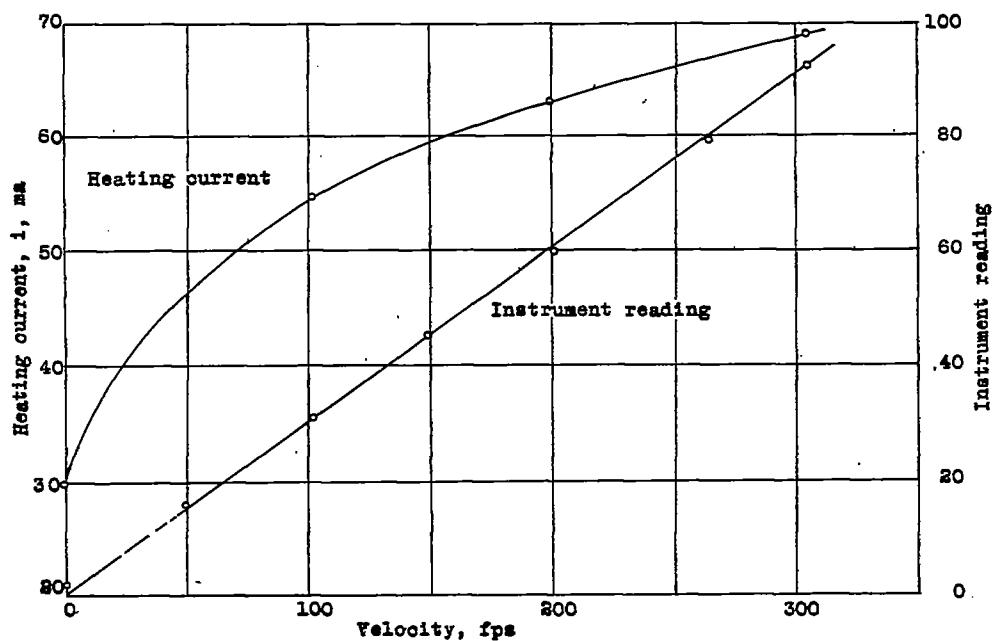

Figure 6.- Calibration curve for linear reading with a wire 0.0005 inch in diameter and 7/32 inch long.

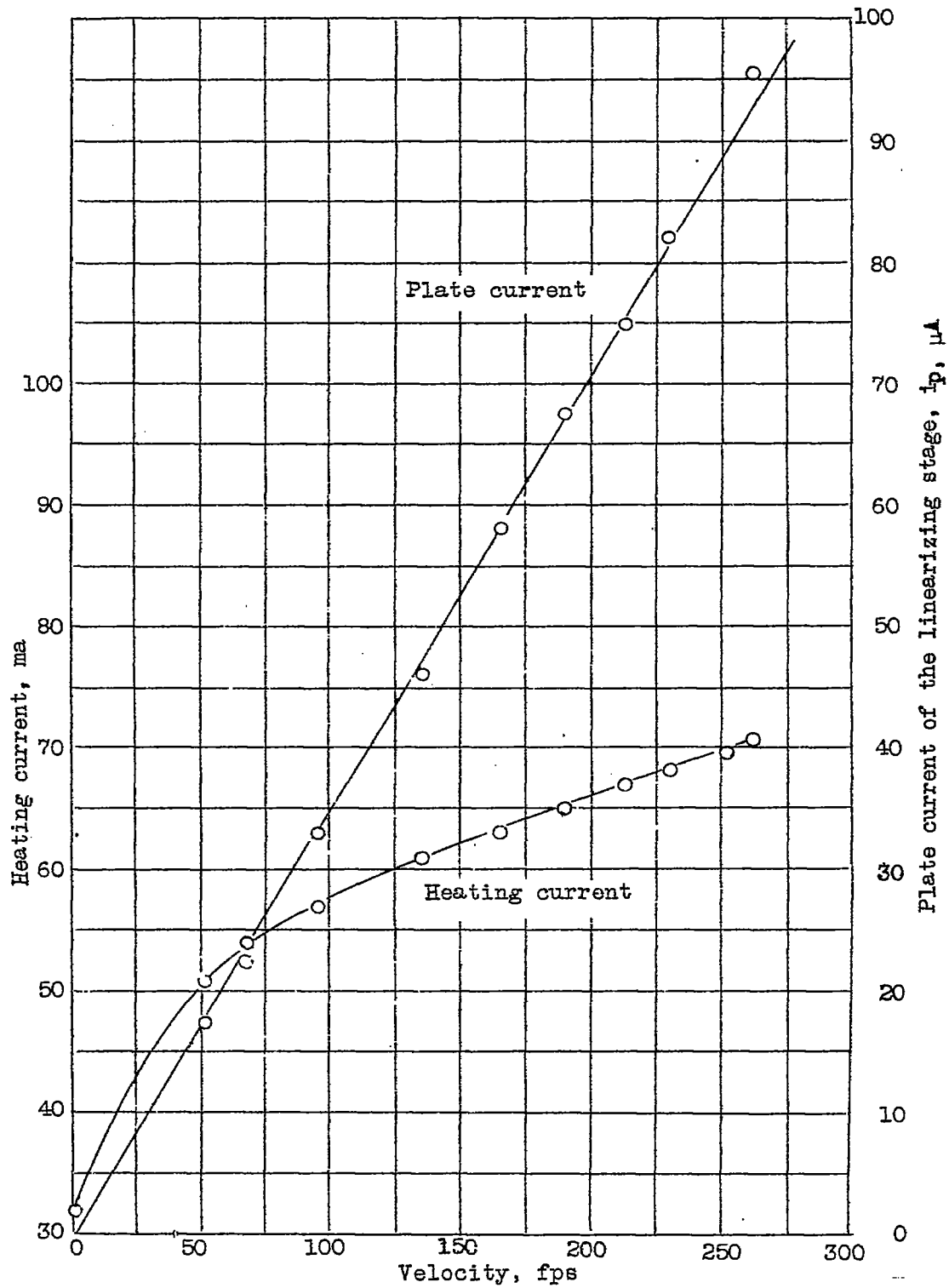

Figure 5.- Calibration curve of the circuit adjusted to linear characteristic.

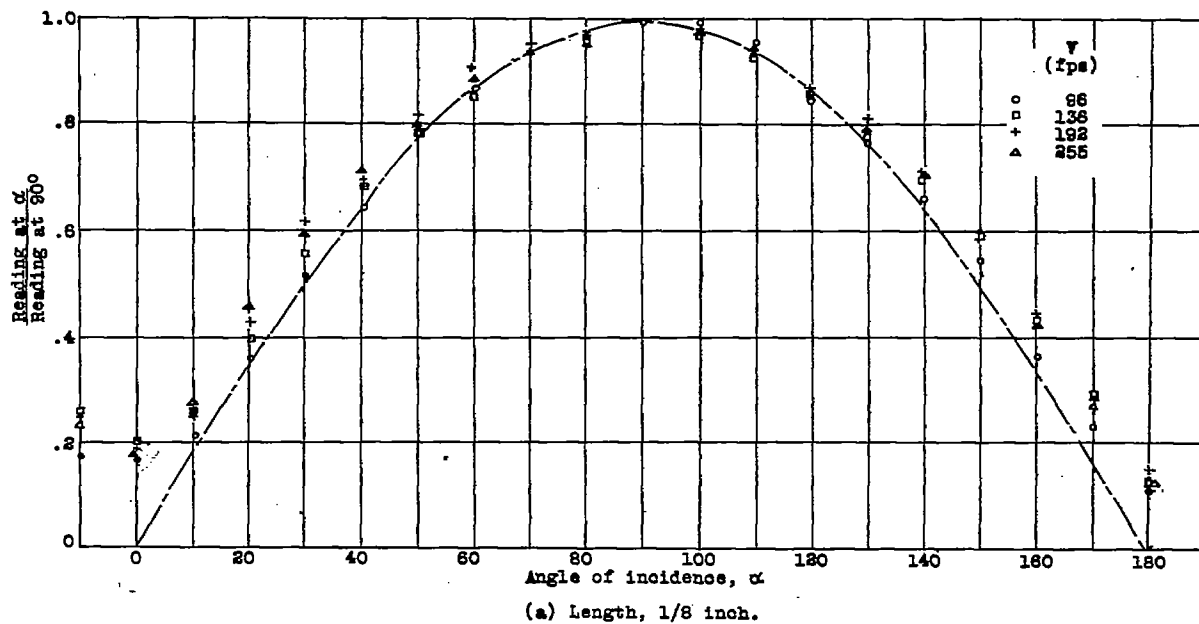

Figure 7.- Directional characteristics for constant-resistance operation and adjustment to linearity of reading. Nickel wire, 0.0005 inch in diameter.

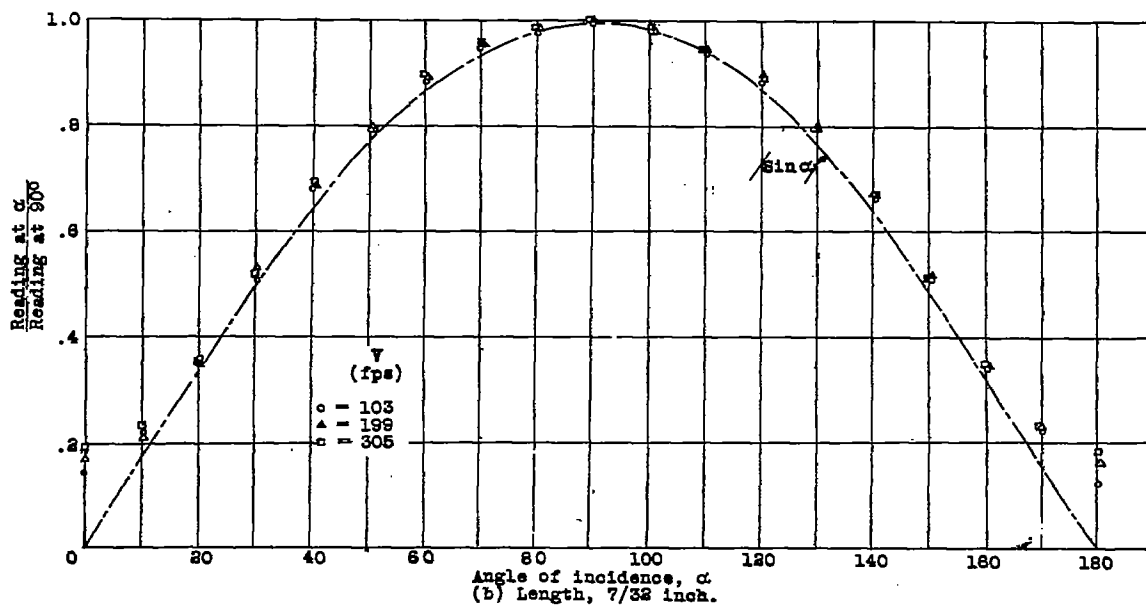

Figure 7.- Concluded.