

FILE COPY  
NO. /



3 1176 00096 1434

TECHNICAL NOTES

NATIONAL ADVISORY COMMITTEE FOR AERONAUTICS

No. 616

NACA LIBRARY  
LANGLEY MEMORIAL AERONAUTICAL  
LABORATORY  
Langley Field, Va.

THE MEASUREMENT OF AIR SPEED OF AIRPLANES

By F. L. Thompson

Langley Memorial Aeronautical Laboratory

THIS DOCUMENT ON LOAN FROM THE FILES OF

NATIONAL ADVISORY COMMITTEE FOR AERONAUTICS  
LANGLEY AERONAUTICAL LABORATORY  
LANGLEY FIELD, HAMPTON, VIRGINIA

RETURN TO THE ABOVE ADDRESS.

REQUESTS FOR PUBLICATIONS SHOULD BE ADDRESSED  
AS FOLLOWS:

NATIONAL ADVISORY COMMITTEE FOR AERONAUTICS  
1724 F STREET, N.W.,  
WASHINGTON 25, D.C.

Washington  
October 1937

NATIONAL ADVISORY COMMITTEE FOR AERONAUTICS

TECHNICAL NOTE NO. 616

THE MEASUREMENT OF AIR SPEED OF AIRPLANES

By F. L. Thompson

SUMMARY

Various methods of measuring the air speed of airplanes are described. Particular emphasis is placed on the procedure required to obtain precise measurements of speed by the use of the suspended pitot-static head or the suspended static head. Typical calibration curves for service installations of pitot-static heads are shown and the relation between errors in air speed and corresponding errors in observed altitude for such installations is discussed. There is included a brief discussion of various speed-course methods of measuring speed.

INTRODUCTION

The measurement of the air speed of airplanes by means of instruments attached to them is an almost universal practice, but the results of such measurements are often very inaccurate, particularly with installations used for normal flight. The sources of error are numerous and not all of them are easily avoided. For special tests it is usual to resort to timed flight over a course between landmarks as a means of obtaining precise measurements of speed. It is possible, however, to measure air speed with a high degree of precision by means of instruments attached to the airplane, and such a method is often more convenient than that of the speed course. Thus the instrument method, if the proper precautions are taken, may be made to supplement or replace the speed-course method.

It is the primary purpose of this paper to discuss, on the basis of experience gained in numerous flight tests conducted at the laboratory of the N.A.C.A., the various sources of error in the instrument method of measuring air speed and to point out as well as possible how the errors may be avoided. The use of a pitot-static tube is assumed. Consideration is given to two aspects of the problem: that of measuring air speed with a high degree of precision for

special tests, wherein it is permissible to use special test equipment; and that of measuring air speed with a fair degree of precision for normal flying. The problem of measuring air speed for normal flying includes consideration of the provision of a satisfactory reference pressure for the altimeter. In addition to the discussion of the instrument method of measuring air speed, there is also included a brief description of various speed-course methods.

### PITOT-STATIC HEAD

The pressure prevailing at the two openings of a pitot-static head subjected to axial air flow are presumably the atmospheric, or static, pressure  $p_s$  and the total, or stop, pressure  $p_t$ . For an incompressible and inviscid fluid the stop pressure is

$$p_s + q$$

where  $q = \frac{1}{2} \rho v^2$  which is usually called the "dynamic" pressure.

As shown by Zahm in reference 1, however, in a compressible fluid the total pressure actually is

$$p_t = p_s \left[ 1 + \frac{(k-1) \rho v^2}{2 k p_s} \right]^{\frac{k}{k-1}}$$

For air  $k$ , the ratio of the specific heats, is taken as 1.40 so that the difference between the incompressible and the compressible total pressures divided by  $q$  can be reduced to the convenient form

$$\frac{q_c - q}{q} = \frac{5}{14} \frac{q}{p_s} + \frac{5}{98} \frac{q^2}{p_s^2} + \dots$$

where the actual impact pressure  $q_c = p_t - p_s$ .

Figure 1 shows the dynamic-pressure correction factor  $\frac{q_c - q}{q}$  in percent plotted against  $q_c/p_s$ .

This relationship is general, that is, independent of atmospheric conditions. In order to illustrate more clearly the significance of the compressibility effect, it can be stated that at sea level  $q_c - q$  becomes 1 percent  $q$  at a speed of about 150 miles per hour and about 7 percent  $q$  at 400 miles per hour. Thus, it appears that the effect of the compressibility is negligible only at low speeds. For the determination of  $V$ , it is necessary to apply the corrections as shown in figure 1 to observed data so as to obtain  $q$  and then to calculate  $V$  in accordance with the

simple relation  $q = \frac{1}{2} \rho V^2$ , which reduces to

$$V_{m.p.h.} = 45.08 \sqrt{q(\text{inches of water})} \sqrt{\rho_0/\rho}$$

It seems advisable to point out, in this connection, that for very accurate determinations of  $V$  the influence of humidity on the density should be taken into account. (See reference 2.) For convenience herein no further distinction will be made between  $q$  and  $q_c$ .

The pitot-static head, when subjected to axial flow, usually develops the correct total pressure but seldom develops exactly the correct static pressure, owing to the effect of structural details of the head itself on the local pressure and velocity. (That the compressibility effect does not influence the static pressure for ordinary pitot-static tubes is indicated in reference 3.) It is possible to design a head for which the error in static pressure is small, but for very accurate work the head should be calibrated. If the pitot-static head is inclined to the air flow, there is, in general, a defect in both the total and static pressures, the magnitude of which depends to some extent on the shape of the tube and the location and type of openings used.

The characteristics of several types of pitot-static tubes, as determined in wind-tunnel tests, are presented in references 4 and 5. Figure 2 illustrates the general character of the effect of pitch or yaw on the total pres-

sure  $p_t$ , the static pressure  $p_s$ , and the dynamic pressure  $q$ . The errors are expressed as a percentage of  $q_0$ , the dynamic pressure indicated by the head when set parallel to the air flow. It will be noted that the error in static pressure starts at very small angles of inclination whereas the error in total pressure does not become appreciable until the angle has exceeded  $10^\circ$ . The resultant error in  $q$  is positive for angles up to approximately  $25^\circ$  and thereafter becomes negative.

### SUSPENDED PITOT-STATIC HEAD

#### Location of Head

It is generally appreciated that all parts of an airplane adjacent to the air stream, the wings in particular, influence the local velocity and the static pressure over a wide field. Generally speaking, these local variations in velocity and static pressure occur without alteration in the magnitude of the total pressure. This statement does not apply, of course, to the propeller slipstream or to the wake, wherein there are losses in total head due to friction. The one convenient way of surely avoiding the interference is to suspend the air-speed head below the airplane by a long cable. Such a head must be fitted with stabilizing surfaces so that it will align itself parallel to the direction of flow. The length of suspension required to avoid appreciable interference with the airplane depends, among other factors, on the lift coefficient and on the size of the airplane; it should ordinarily be defined in terms of span lengths. The air-speed head, under no circumstances, will hang directly below the machine because of the drag, principally of the cable. Thus, when the suspension length required is considered, it is necessary to take into account the fact that the head will swing backward and upward.

In order to determine what the location of the suspended head relative to the airplane should be, the induced velocities in the region below and behind the wing have been analytically investigated. It is assumed that the head will be suspended from the fuselage and, hence, will lie in the plane of symmetry so that the equations given by Glauert in reference 6 can be reduced to the following forms:

$$\frac{u}{V} = - \frac{C_L}{8\pi A} \frac{k_Z}{k_X^2 + k_Z^2} \frac{1}{\sqrt{k_X^2 + k_Z^2 + \frac{1}{4}}}$$

$$\frac{w}{V} = \frac{C_L}{8\pi A} \left[ \frac{k_X}{k_X^2 + k_Z^2} \frac{1}{\sqrt{k_X^2 + k_Z^2 + \frac{1}{4}}} + \frac{1}{k_Z^2 + \frac{1}{4}} \left( 1 + \frac{k_X}{\sqrt{k_X^2 + k_Z^2 + \frac{1}{4}}} \right) \right]$$

where  $u$  is the induced velocity component parallel to  $V$  (positive forward).

$w$ , the induced velocity component perpendicular to  $V$  (positive downward).

$A$ , an effective aspect ratio; for monoplanes, approximately  $\frac{b^2}{S}$ .

$k_X$  and  $k_Z$ , space coordinates measured from the wing aerodynamic center as origin, expressed in terms of span lengths  $b$ .

The term  $k_X = \frac{x}{b}$  (positive backward) and  $k_Z = \frac{z}{b}$  (positive downward). The error due to the horizontal component  $u$  is given directly by the expression for  $\frac{u}{V}$  but, since the vertical component  $w$  is perpendicular to  $V$ , the error is given by  $\frac{1}{2} \left( \frac{w}{V} \right)^2$  (approximately). It follows that the magnitude of the resultant velocity to which the suspended head is subjected is influenced chiefly by the  $u$  components, the  $w$  components having a large effect on the angle of flow but no appreciable influence on the magnitude except for positions close to the  $X$  axis.

Figure 3 shows contours of constant  $\frac{u}{V}$  as obtained

by the preceding method of calculation for a lift coefficient ( $C_L$ ) of 2 and an aspect ratio ( $A$ ) of 6. The error for other values of  $C_L$  and  $A$  is readily obtainable from figure 3 inasmuch as the error is directly proportional to  $C_L$  and inversely proportional to  $A$ . Since the  $u$  components in this region tend to decrease the resultant velocity, whereas the  $w$  components tend to increase it, it follows that with  $w$  neglected the result and error at points close to the  $X$  axis is slightly overestimated.

It appears from figure 3 that, with a given effective suspension length  $l$ , it is advantageous to have the head swing backward. (Owing to curvature of the cable the effective length will vary to some extent with speed and will always be a little less than the actual cable length.) For the assumed lift coefficient of 2 and aspect ratio of 6, a suspension length of 1.5 span lengths appears to be sufficient to keep the error from exceeding 0.5 percent unless the head should hang practically straight downward, an unlikely condition. At high speed the error would disappear because the head would swing farther backward, approximately along an arc into a region of reduced error, and also because the lift coefficient would be small. The fact that the backward displacement of the head is advantageous is of particular interest for large airplanes where there is a possibility of suspending the head at a point near the tail so as to reduce the suspension length required.

#### Type of Head

There is no standard type of suspended pitot-static head. One type that has been used a great deal by the Committee is shown in figure 4(a). A more recent design is shown in figure 4(b). The latter head, some details of which are shown in figure 5, has the advantage of being more compact and rugged than the older type. In both cases a ring of static holes, rather than a slot, is used for the static-pressure opening to avoid possibility of damage. If the head is too light in proportion to the drag of the cable, it will trail almost straight back at high speeds and there is danger that the cable may foul the tail of the airplane. A weight of about 20 pounds is about all that an observer will care to handle, unless a reel is provided, and it seems likely that that weight is all that will be required. Experience in the use of suspended heads at

high speeds is lacking, however, and such use may have an important bearing on conclusions regarding the optimum weight.

#### Method of Suspension

A convenient way to suspend the pitot-static head is to use a small flexible cable, say  $1/8$  inch in diameter, with a pair of rubber tubes taped to it to conduct the static and dynamic pressures. The internal diameter of the tubing should not be less than  $3/32$  inch, and the outside diameter should not exceed  $1/4$  inch. If the head is to be used at moderately high speeds, it is probably better to limit the tubing size to an outside diameter of  $3/16$  inch so that the complete cable will not exceed  $3/8$  inch in diameter.

#### Air-Speed Indicator or Pressure Gage

The pressure difference at the upper ends of the tubes in the airplane can be satisfactorily observed by means of a commercial type of air-speed indicator or other suitable pressure gage. The instrument should be checked for leaks, for the effect on its calibration of changes in temperature, or attitude, and for "hysteresis." It is of minor interest to note that the instrument will indicate a dynamic pressure for an air density corresponding to that at the level of the indicating mechanism, rather than that at the level of the suspended head. This statement is based on the justifiable assumption that the temperature of the air in the two sides of the system will be equal.

#### Lag Error Due to Change in Altitude

In many cases it will be desired to measure the air speed with the suspended head while the airplane is either gliding or climbing. In such cases there will be an equal rate of change of pressure at each opening of the air-speed head and it should be appreciated that erroneous readings will probably be obtained unless precautions are taken to eliminate unequal lag effects in the air-speed lines. In general, an inequality in the lag characteristics will exist because of the difference in volume of the two sides of the system, or a difference in the restrictions in the lines. The static side of an air-speed indicator, for example, has a very large volume compared



with that in the dynamic side, and in some cases there are additional instruments connected to the static side of the air-speed head. A simple test will show whether or not the lag characteristics in the two sides of the system are equal. A small pressure is applied simultaneously at both openings of the pitot-static head and, as this pressure is released so as to simulate the simultaneous variation of pressure in both sides of the system experienced in climbing or descending, the reading of the air-speed indicator or pressure gage is observed. If there is an appreciable deflection of the indicator, the system requires modification. The modification consists simply of adding additional volume to the gage end of the side of the system that shows the least lag.

#### Errors Due to Wind Gradient

Another possible source of error with the suspended head is introduced by the variation of wind velocity with altitude. It is entirely possible under normal atmospheric conditions for the wind velocity at the elevation of the airplane to be, say, 1/2 to 1 mile per hour different from that 50 or 100 feet below the airplane. If such is the case, there will be an appreciable error in the air-speed measurements. In order to avoid this source of error, it is advisable to use the average readings of flights made in opposite directions at approximately the same time.

#### Drag of Suspended Head

The chief aerodynamic force acting on the cable of the suspended instrument is one perpendicular to the cable, components parallel to the cable being small. Furthermore, the drag of the head itself in proportion to its weight will probably not be great enough to cause any large increase in the magnitude of the resultant force acting on the head. It follows that the tension in the cable at the point of attachment to the airplane remains approximately equal to the weight of the cable plus the weight of the air-speed head. The drag of the suspended instrument, therefore, can readily be estimated from the weight and the angle of the cable at the point of attachment to the airplane relative to the flight path. Even at moderate speeds this angle is small, so that the drag becomes approximately equal to the weight. In any event, a rough estimate of the drag component is likely to be sufficient.

### Stability of Suspended Head

Experience with numerous suspended instruments at speeds up to about 150 miles per hour has indicated little likelihood of any serious instability of the suspended head when cable lengths ranging from about 70 to 100 feet are used. When the suspension length is very short, however, instability is likely to develop. Thus, it may sometimes be found that, when a suspended head is slowly hauled back into the airplane, oscillations will be set up during the last few feet of travel. This condition can usually be overcome by a brisk handling of the head. It is advisable, however, to fly slowly while the instrument is being paid out or retrieved, at least until experience has been obtained with the instrument. Stability at low speeds, however, does not insure stability at high speed. The results of reference 7 indicate that instability at high speeds will probably be encountered unless proper precautions are taken in designing the suspended instrument and that, for use at high speed, a heavy instrument with a long tail of small dimensions is desirable whereas a large moment of inertia is undesirable. It would appear from these results that the critical velocity of the head shown in figure 5, for example, might be increased by replacing the present tail surfaces with much smaller ones mounted on a light spindle well back of the present position.

### SUSPENDED STATIC HEAD

An alternative for the use of the pitot-static head as previously described is to use the suspended head to obtain only a measure of the true static pressure. Since the total pressure is, in general, not altered by the proximity of the airplane, a measure of the correct total pressure can be obtained by means of a pitot head mounted on the airplane outside the wake or slipstream, provided that precautions are taken to avoid errors due to inclination of the head to the direction of the air flow. Such errors can be avoided either by mounting the head on a pivot so that it is free to rotate in pitch or by using a type of head that is free from error for large angles of inclination, such as the type of head described in reference 8. A total-head meter, proportioned as shown in figure 6, has been found to give correct readings for inclinations of nearly 40°.

When a suspended static head is used, the temperature of the air within the connecting tube is assumed to be essentially the same as that of the ambient air, so that the pressure drop due to the difference between the elevation of the airplane and the head is the same inside the tube as outside. Superheating of the tube due to the absorption of rays from the sun and the effect of lag in temperature transmission during altitude changes would be expected to cause some inequality of temperatures. A flight investigation of the possibility of appreciable error from this cause disclosed a maximum superheating of 2.6° F. in bright sunshine within a rubber tube encased in black tape, the black tape being used to insure a maximum absorption of heat. An additional lag error of about 3° was found when the rate of temperature change was 3° F. per minute. The resultant effect in a climb was a temperature difference of nearly 6° F., whereas in a glide the net effect was practically zero. In order to estimate the corresponding error in recorded dynamic pressure, consider that, for standard sea-level conditions (absolute temperature, 519° F.; pressure, 29.92 inches Hg), the pressure drop with height is 0.0147 inch of water per foot. With a 6° F. temperature rise the resultant pressure error for an elevation difference of 100 feet between the air-speed head and the airplane would be

$$\Delta p = \frac{6}{519} \times 0.0147 \times 100 = 0.017 \text{ inch of water}$$

This error, which would have the effect of reducing the recorded dynamic pressure, would be equal to approximately 1 percent  $q$  at a speed of 60 miles per hour. This error corresponds to the climbing condition, and the error in level flight or glide would be considerably less, if not actually zero. In general, the error can therefore be neglected.

An important advantage of the suspended static head over the suspended pitot-static head is that it eliminates error due to relative motion between the head and the airplane because the static pressure given by the suspended head is independent of speed. Errors due to unsteadiness of the suspended head or to a gradient of wind velocities with height are therefore eliminated and there is likely to be less scattering of observed data than would be the case with a suspended pitot-static head. Another advantage of a suspended static head is that it requires only a single tube rather than a pair of tubes; hence, it has less drag and is somewhat easier to handle. Furthermore,

the head is easier to construct because of the elimination of the extra opening.

In other respects the two methods are similar. The same precautions that were mentioned in the discussion of the use of a pitot-static head must be observed to eliminate leaks and lag errors due to changing altitude.

#### FIXED PITOT-STATIC HEAD

The question of the proper location for a fixed air-speed head that will give accurate results constantly recurs. The answer is usually disappointing. The fixed head is ordinarily subjected to angles of pitch over a considerable portion of the speed range, and wing interference cannot be avoided with the fixed head to the extent that is possible with the suspended head. In fact, with any installation of a fixed head, it will probably be necessary to accept an appreciable error at some speeds. In consideration of the errors incurred, it is worth noting that, at the present time, the problem is not only to obtain a correct value of dynamic pressure but to obtain simultaneously a source of correct static pressure for altitude reference.

#### Errors for Typical Installations

The magnitude of the installation error in any given case is, of course, the resultant of several effects and is often very large. The errors in indicated air speed  $V_i$  for three typical cases are shown in figure 7. Figure 7(a) is typical for a low-wing monoplane, the head being located  $0.25c$  forward of the wing, as indicated in the figure. The large difference between the curves for the power-on and the power-off conditions is noteworthy. Figure 7(b) applies to a high-wing monoplane equipped with partial-span flaps but, as shown on the figure, the use of the flaps had no influence on the calibration. As in the previous case, the use of power had a marked effect. Figure 7(c) shows the calibration for another high-wing monoplane with the head located below and very slightly behind the leading edge of the wing. The error at minimum speed in this case was very large but the application of power had no effect.

In order to obtain an indication of the magnitude of

the error in the altimeter reading that would result in the cases shown in figure 7 if the altimeter were connected to the static side of the air-speed head, it is permissible to assume that the errors in indicated air speed correspond to equivalent errors in static pressure. The equivalent errors in static pressure, expressed as a percentage of  $q$  for any given case, would be approximately twice the error in indicated velocity. In other words, it may be assumed that an error of, say, 10 percent in indicated velocity corresponds to a static-pressure error equal to about 20 percent  $q$ . In figure 8, the altimeter error in feet is plotted against static-pressure error in percentage of  $q$  for various speeds. This figure shows that an error in static pressure equal to 20 percent  $q$  at speeds between 50 and 100 miles per hour would correspond to an altimeter error ranging from about 20 to 70 feet. The altimeter error would remain under 10 feet if the static-pressure error were 3 percent  $q$  or less.

#### Satisfactory Locations of Fixed Head

For flight tests at the N.A.C.A. laboratory a procedure that gives satisfactory results consists in mounting a head, which is free to rotate in pitch and thus to align itself parallel to the direction of the relative wind, on a long boom extending one chord length forward from the wing of a monoplane or the upper wing of a biplane. It is preferable that the head should be a little below the chord line. Errors due to inclination of the flow are thus eliminated and the error due to wing interference is reduced to a very small magnitude except at the extreme lower end of the speed range. At minimum speed an error in indicated air speed of 2 to 5 percent would be typical. This type of installation ordinarily does not entirely obviate the necessity for calibration but, when the calibration is obtained, it is applicable within reasonable limits to all flight conditions; that is, to climbs, glides, pull-ups, take-offs, etc.

Another installation that has often been suggested consists of a fixed head mounted a little behind and above the wing. Results of a survey around wings in the N.A.C.A. full-scale wind tunnel (reference 9) indicated that, with a plain wing, such an installation would give an accuracy within 2 or 3 percent of  $V_i$  at all flight speeds. An objectionable feature is that the use of flaps introduces very large errors.

## SPEED-COURSE METHODS

There are several variations of the basic speed-course method of determining the true air speed from timed flight in opposite directions between given points on the surface of the earth. The deduction of true air speed from the results of such tests presupposes that the stipulated course is closely followed, that the wind speed is constant both as regards its magnitude and direction, and that the timing is accurate. For satisfactory results the wind should be steady and of low velocity relative to the speed of the aircraft. Large cross-wind components are likely to introduce difficulty in following a prescribed ground course. Accurate timing demands care in determining the exact time at which a specific point or line is passed. Whether the observer is located in the airplane or on the ground, care should be taken to make certain that his line of sight is directed perpendicular to the course. A brief description of various methods follows:

The most familiar speed-course method is probably that in which the airplane is flown in opposite directions along a straight ground course between two points. In the general case there would be a wind velocity  $V_w$  inclined at an angle  $\theta$  to the ground course, so that the cross-wind component (perpendicular to the ground course) is  $V_w \sin \theta$ . In following the ground course the airplane will have an angle of drift  $\phi$ . The average true air speed for a pair of runs in opposite directions is then found from either

$$V = \left( \frac{L}{t_1} + \frac{L}{t_2} \right) \frac{1}{2} \times \frac{1}{1.467} \times \frac{1}{\cos \phi}$$

or

$$V = \sqrt{\left[ \left( \frac{L}{t_1} + \frac{L}{t_2} \right) \frac{1}{2} \frac{1}{1.467} \right]^2 + (V_w \sin \theta)^2}$$

where  $V$  is the average true air speed in miles per hour.

$L$ , the length of the course in feet.

$t_1$  and  $t_2$ , the times in seconds for runs in opposite directions.

Under favorable conditions the cross-wind component will be negligible so that for practical purposes  $\cos \phi$  will be unity or  $\sin^2 \theta$  will be zero.

A variation of this method that eliminates the difficulty of following a straight ground course with a cross wind requires the use of two parallel lines, such as roads, as the landmark, or an equivalent set-up depending upon whether the timers are in the airplane or on the ground. The airplane, in this case, is flown in opposite directions on a compass course set perpendicular to the parallel lines without reference to the drift. The crossing time  $t_1$  and  $t_2$  are observed and the average true air speed (m.p.h.) is found from

$$V = \left( \frac{L}{t_1} + \frac{L}{t_2} \right) \times \frac{1}{2} \times \frac{1}{1.467}$$

where  $L$  is the distance between the lines.

It is apparent that, when the observers are located on the ground, the actual landmarks need only to be points, as in the first case, provided that the observers are equipped with sighting apparatus set perpendicular to the ground course between the two points so that parallel sighting lines can be accurately established.

Sometimes methods are employed that make use of either a triangular closed course or two neighboring, but not necessarily adjoining, straight courses arranged in the shape of an L or T that must be traversed in opposite directions so that, in effect, there are four mutually perpendicular legs. Results obtained from flights over such courses are ordinarily evaluated graphically as the analytical solution is too laborious for convenience. Vectors representing the ground speed for the various legs of the course are laid out from a common point in directions corresponding to the geographical orientation of the legs. (See reference 2.) The extremities of these vectors determine a circle, the radius of which is the average true air speed  $V$ . The magnitude and direction of the wind velocity are also given by a vector drawn from the origin of the ground-speed vectors to the center of a circle. Since only three vectors are required for the determination of the circle, the use of the L or T course with four legs makes it possible to obtain in some measure a check on the accuracy of the results. With regard to

the triangular course, it should be noted that for maximum precision in the determination of a circle the triangle should be approximately equilateral.

The length of any leg of a speed course should be long enough so that inadvertent timing errors do not introduce appreciable errors into calculated speed. Thus, the length of the course required tends to increase with increase of speed and to decrease with increased precision of timing. The time required to traverse a 2-mile course at an air speed of 72 miles per hour is 100 seconds, more or less, depending on the wind speed. If the accidental timing error for this speed is of the order of  $\pm 1/4$  second, which is a reasonable value, the resultant error in velocity would be  $\pm 1/4$  percent. In order to obtain the same accuracy at 200 miles per hour, however, it would be necessary either to triple approximately the length of the course, making it about 6 miles long or to reduce the timing error to about  $\pm 1/12$  second. This precision of timing could hardly be obtained without elaborate apparatus so that lengthening the speed course would ordinarily be the easier method.

Langley Memorial Aeronautical Laboratory,  
National Advisory Committee for Aeronautics,  
Langley Field, Va., September 25, 1937.



## REFERENCES

1. Zahm, A. F.: Pressure of Air on Coming to Rest from Various Speeds. T.R. No. 247, N.A.C.A., 1926.
2. Thompson, F. L.: Procedure for Determining Speed and Climbing Performance of Airships. T.N. No. 564, N.A.C.A., 1936.
3. Lock, C. N. H., and Hilton, W. F.: Calibration of Standard Pitot-Static Heads in the High-Speed Tunnel. R. & M. No. 1752, British A.R.C., 1936.
4. Kumbruch, H.: Pitot-Static Tubes for Determining the Velocity of Air. T.M. No. 303, N.A.C.A., 1925.
5. Merriam, Kenneth G., and Spaulding, Ellis R.: Comparative Tests of Pitot-Static Tubes. T.N. No. 546, N.A.C.A., 1935.
6. Glauert, H.: The Elements of Aerofoil and Airscrew Theory. Cambridge University Press, 1930, pp. 158-159.
7. Koning, C., and DeHaas, T. P.: The Critical Velocity of a Body Towed by a Cable from an Airplane. T.M. No. 832, N.A.C.A., 1937.
8. Kiel, G.: Total-Head Meter with Small Sensitivity to Yaw. T.M. No. 775, N.A.C.A., 1935.
9. Parsons, John F.: Full-Scale Wind-Tunnel Tests to Determine a Satisfactory Location for a Service Pitot-Static Tube on a Low-wing Monoplane. T.N. No. 561, N.A.C.A., 1936.

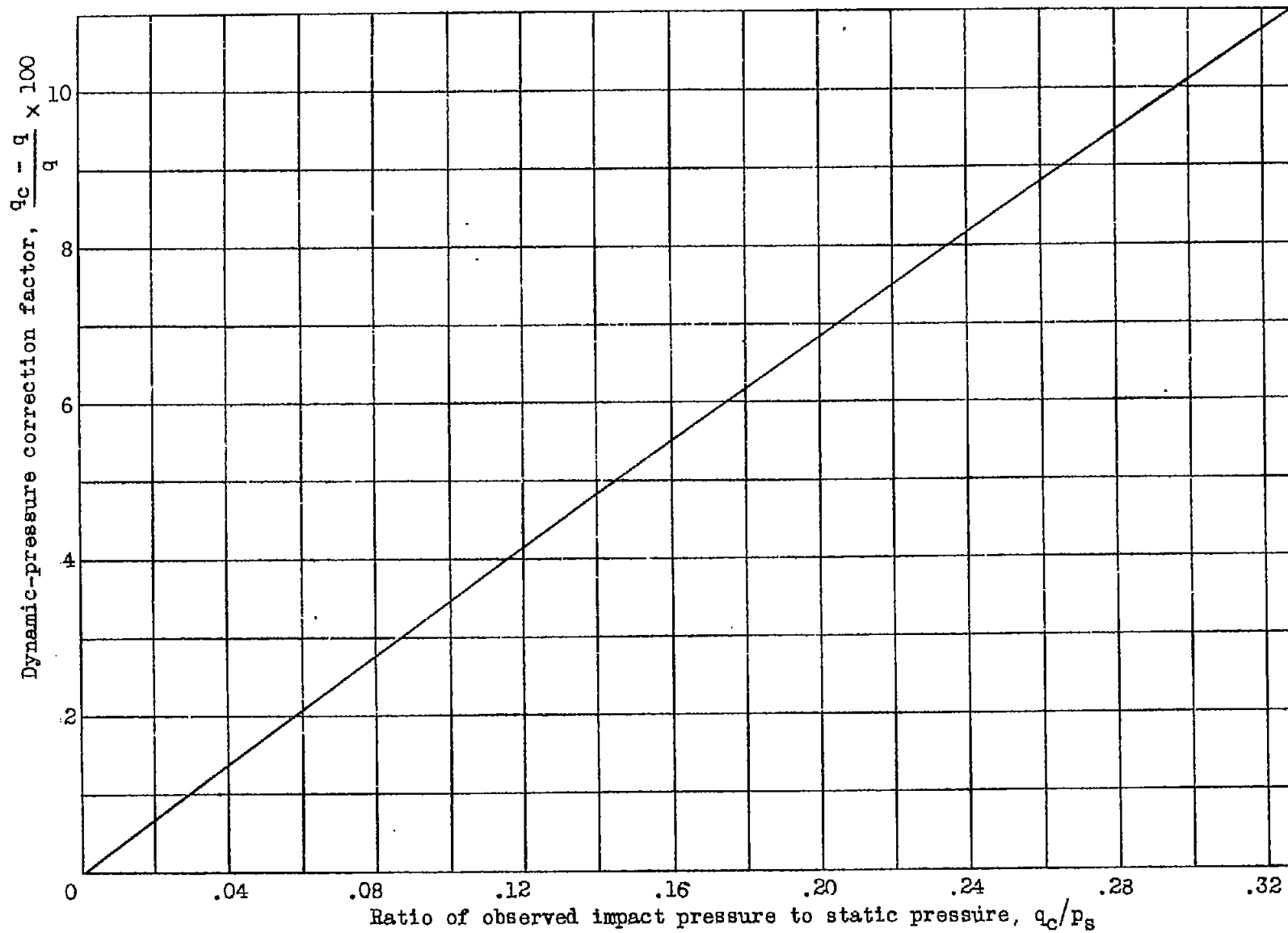

Figure 1.- Effect of compressibility on impact pressure.

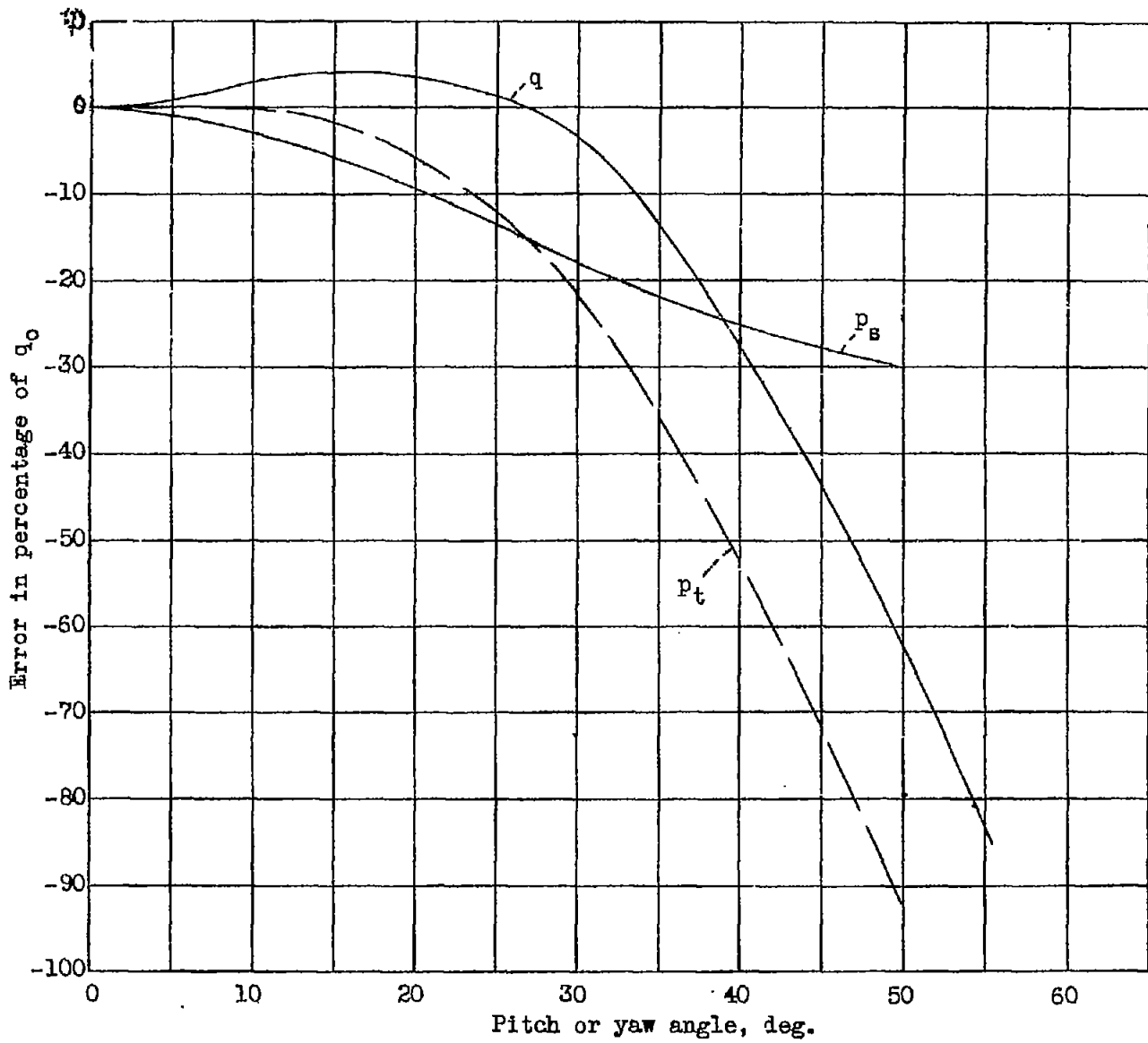

Figure 2.- Typical effect of inclination on pitot-static tube.

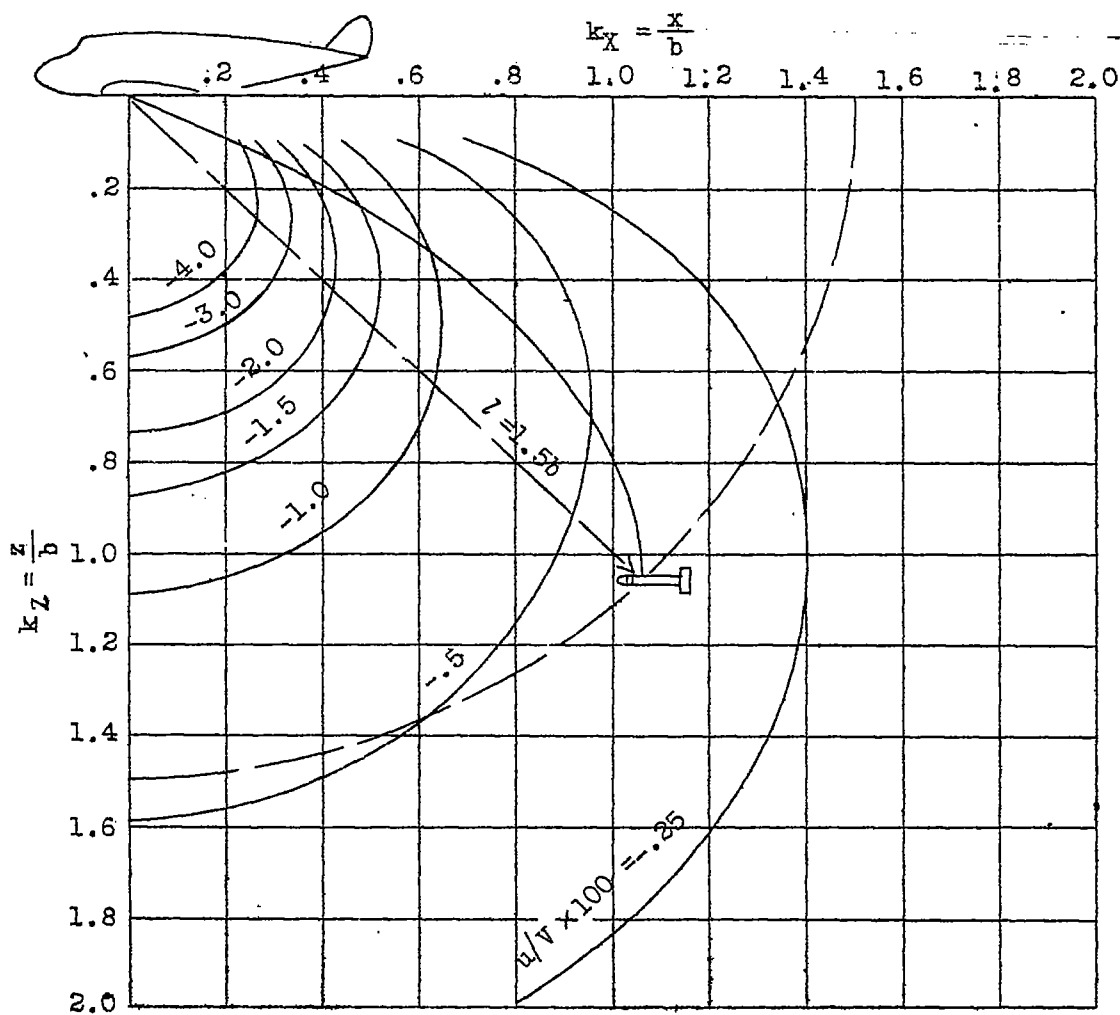

Figure 3.- Induced-velocity contours.  $C_L, 2$  ; A,6.

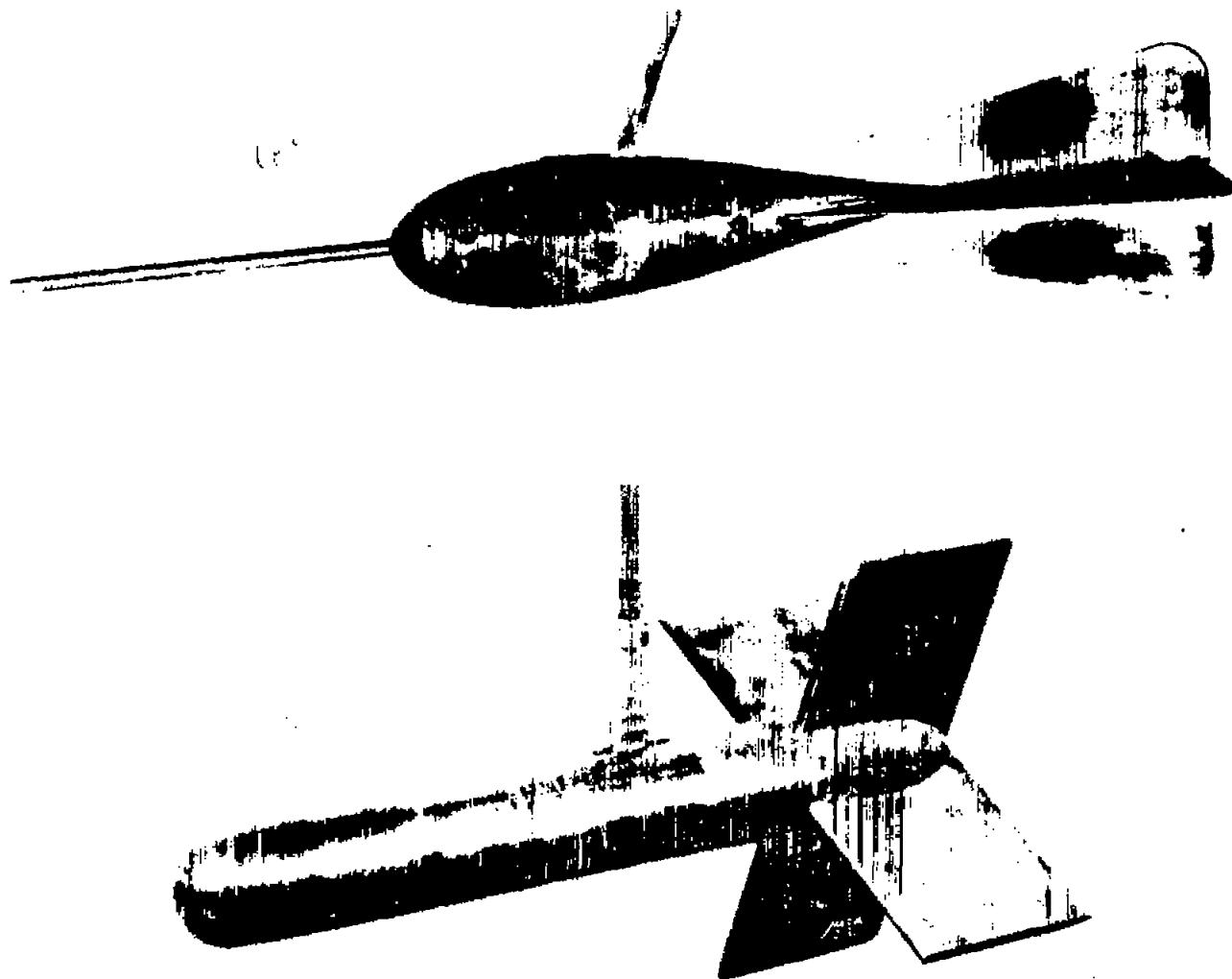

Figure 4.- Suspended air-speed heads



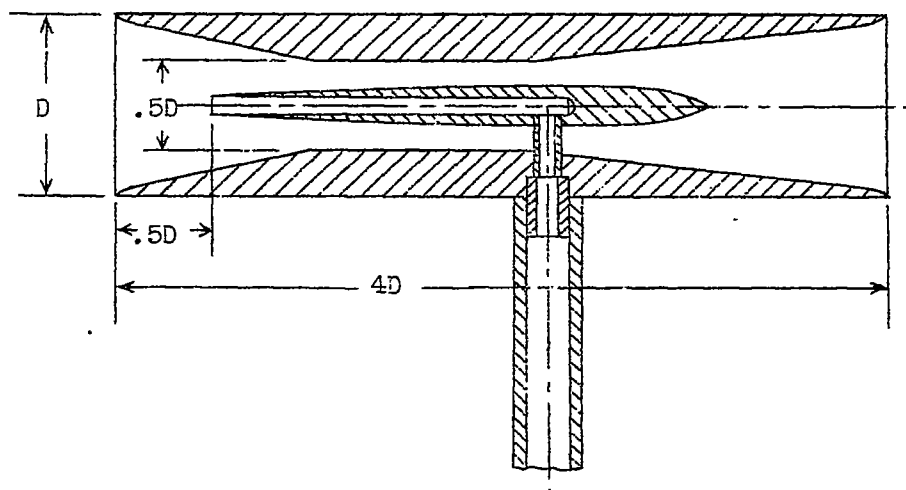

Figure 6.- Total-head meter (reference 7, fig. 9).

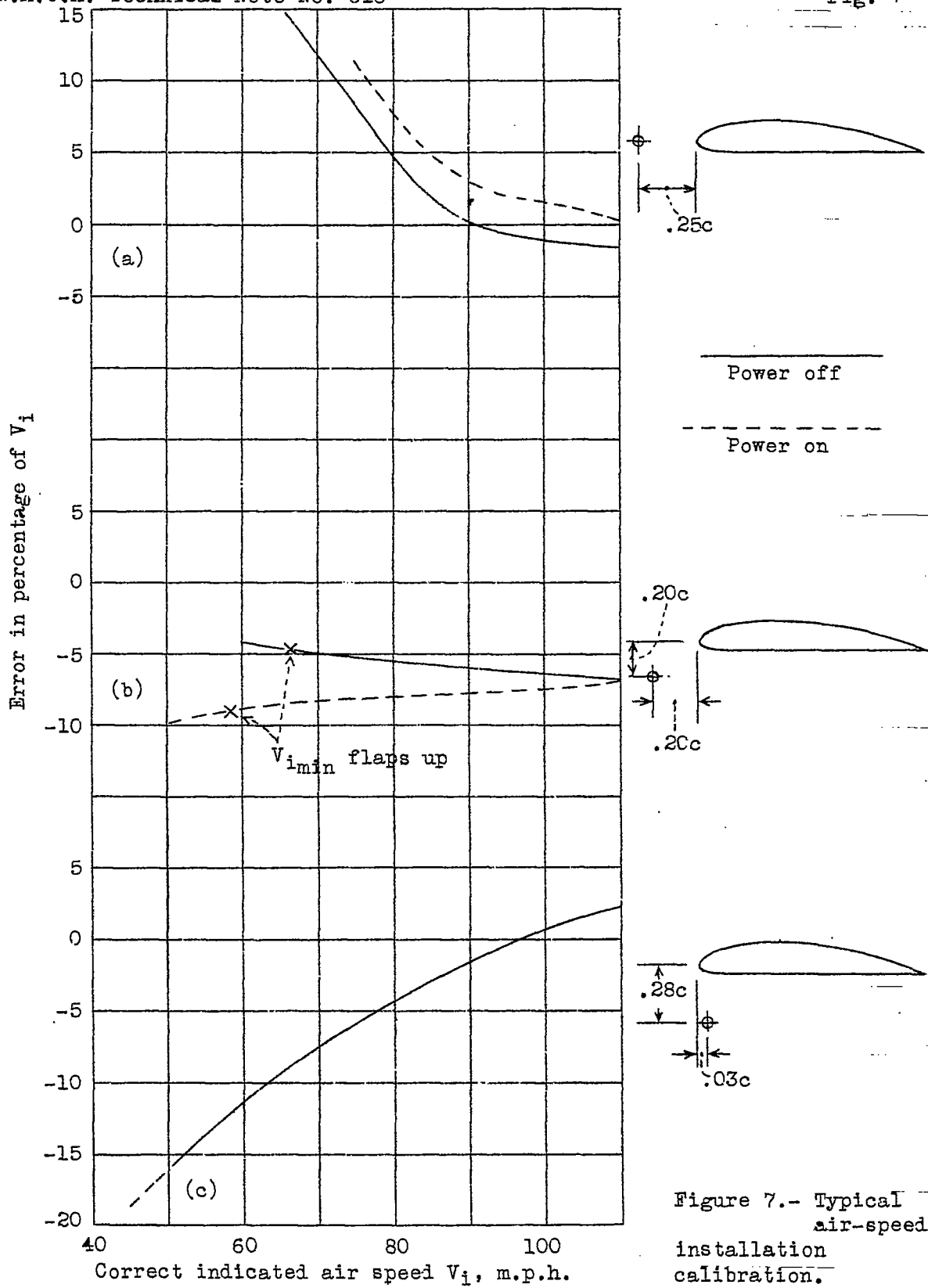

Figure 7.- Typical air-speed installation calibration.



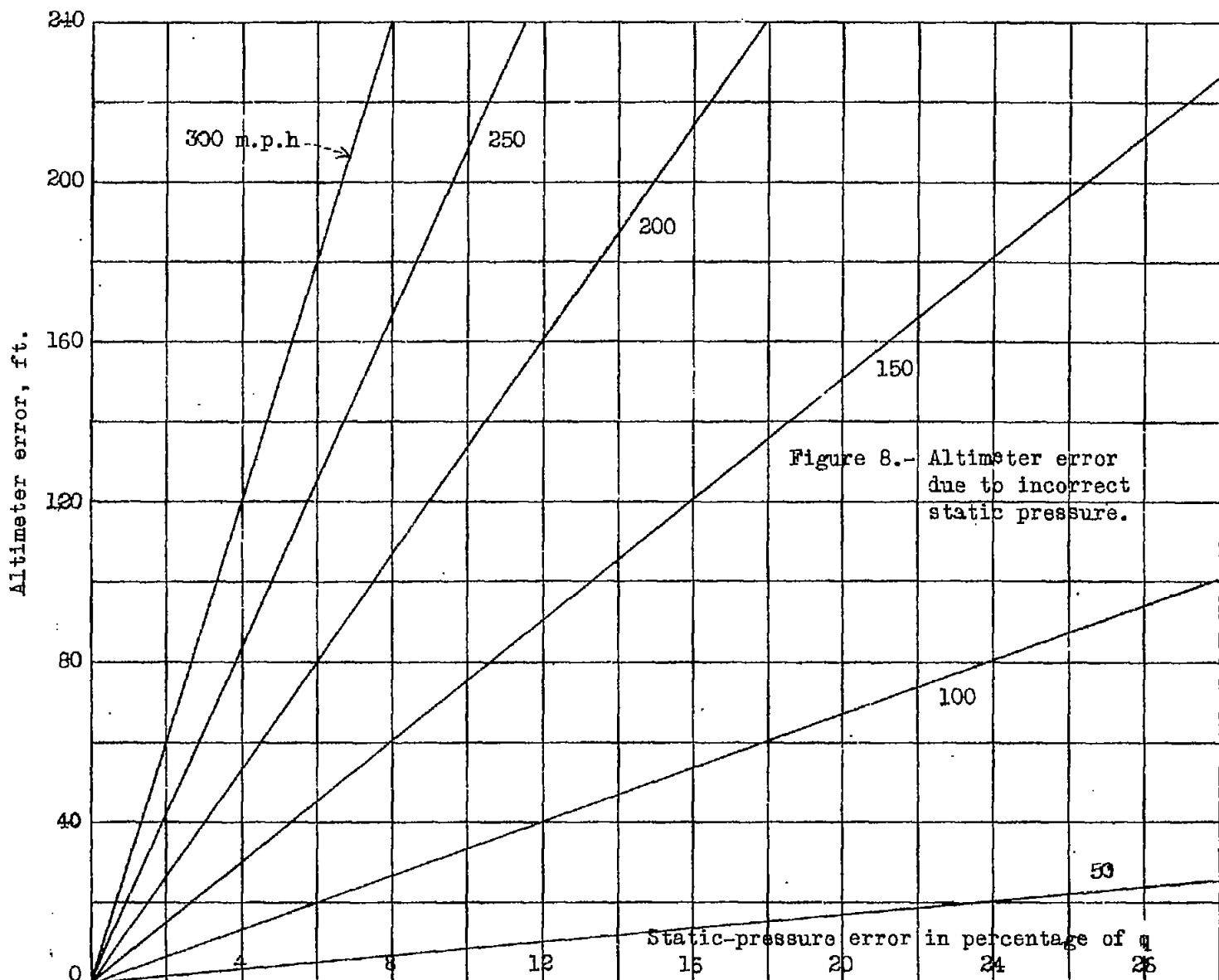

Figure 8.- Altimeter error due to incorrect static pressure.