

Library L.M.A.L.

TECHNICAL NOTES

NATIONAL ADVISORY COMMITTEE FOR AERONAUTICS

No. 602

HEAT TRANSFER FROM CYLINDERS HAVING CLOSELY SPACED FINS

By Arnold E. Biermann
Langley Memorial Aeronautical Laboratory

Washington
May 1937



3 1176 01433 6870

NATIONAL ADVISORY COMMITTEE FOR AERONAUTICS

TECHNICAL NOTE NO. 602

HEAT TRANSFER FROM CYLINDERS HAVING CLOSELY SPACED FINS

By Arnold E. Biermann

SUMMARY

The heat-transfer coefficients have been determined for five steel cylinders having fins 1.22 inches wide and the spacing between the fins ranging from 0.022 to 0.131 inch. The cylinders were tested with and without baffles in a wind tunnel; they were also tested enclosed in jackets with the cooling air supplied by a blower.

A maximum heat transfer was reached at a fin space of about 0.045 inch for the cylinders tested with each of the three methods of cooling investigated. The rise in temperature of the air passing between the fins and the change in flow pattern were found to be important factors limiting the heat transfer that may be obtained by decreasing the fin space.

The use of baffles for directing the air around the cylinders with closely spaced fins proved very effective in increasing the over-all heat-transfer coefficient provided that the spacing was not appreciably less than that for maximum heat transfer.

INTRODUCTION

The results of a theoretical analysis and experimental tests made to determine the heat dissipated from finned cylinders have shown that the over-all heat-transfer coefficient of the conventional fin construction may be increased by adding more fin area. Very large rates of heat flow may be obtained by increasing the fin width and thickness. A more practical method of improving the heat transfer of the conventional fin design, however, is to increase the fin area by reducing the space between the fins and at the same time to maintain optimum proportions of width, space, and thickness. These changes result in a much lighter and more compact fin construction for the same

heat transfer than is otherwise possible. For this reason the method is the most desirable for aircraft engines.

Tests made at this laboratory and elsewhere have indicated the need for a determination of the heat transfer from finned cylinders having more closely spaced fins than have hitherto been tested. The minimum fin space tested by Taylor and Rehbock (reference 1) with rectangular copper fins soldered to a flat plate was 0.063 inch. This investigation and tests by the N.A.C.A. (reference 2) of finned steel cylinders having a space between fins of 0.060 inch showed that the maximum heat transfer for these surfaces is to be obtained with a fin space less than 0.060 inch.

The present work, which is part of a general investigation to determine the optimum fin constructions for various conditions of air flow, was undertaken to determine the fin spacing giving the maximum heat transfer. The work of this report covers the experiments made with fins of one width and one thickness in which the space between the fins was varied over a range from 0.022 to 0.131 inch. The quantity of heat dissipated by a given arrangement of fins was determined with the cylinders mounted in a wind tunnel, with and without baffles, and also in jackets with the cooling air supplied by a blower.

TEST APPARATUS

Five steel cylinders having identical fins of rectangular section and of 1.22-inch width and 0.035-inch thickness, but of varying pitch, were tested. Each fin was constructed integrally with that portion of the cylinder wall which formed its base as shown in figure 1. The cylinder-wall shoulder of each fin was varied in width by machining to give pitches of 0.166, 0.135, 0.111, 0.083, and 0.057 inch and the adjacent shoulder surfaces were sweated together during assembly to form an integral cylinder. The test portion of each cylinder was 4.66 inches in outside wall diameter and 5 inches in length. The steel used was S.A.E. 1050 forged stock, heat-treated to a Brinell hardness of approximately 200.

As the fin width and thickness were the same for all the cylinders of these tests, the fins will be designated simply by the pitch of the fins, as 0.166, 0.136, 0.111, 0.083, and 0.057.

The test cylinders were electrically heated and tested with guard rings as described in reference 2. The assembled over-all length of the guard rings and the test section was in each case 10 inches. In all tests the electrical heating elements and measuring instruments were essentially the same as described in reference 2. The locations of the iron-constantan thermocouples used for measuring the surface temperatures are shown in figure 1. The type of baffle used is shown in figure 2. The ratio of the exit area to the area between the fins was approximately 2. This proportion of areas as well as the baffle design was found in previous tests (reference 3) to give good results. The tunnel air speed was measured with a pitot tube located ahead and to one side of the test cylinder.

The apparatus used for the tests in which a blower draws air over the test cylinders enclosed in a jacket is described in reference 4. The jacket used in these tests is shown in figure 3. The weight of air passing through the jacket was measured with thin-plate orifices placed in the end of a large tank.

TESTS

All tests were conducted with a constant heat input of approximately 95 B.t.u. per square inch of wall area per hour and with air speeds ranging from 30 to 150 miles per hour in the wind-tunnel tests and with weight velocities of the cooling air ranging from 1.37 to 13.8 pounds per second per square foot of free area between fins in the tests with blower cooling.

Wind-tunnel tests with baffles were not made of the 0.166 and 0.136 cylinders.

COMPUTATIONS

Air speed.- All tunnel air-speed readings were corrected to a specific weight of 0.0734 pound per cubic foot, which corresponds to a barometric pressure of 29.92 inches of Hg and an air temperature of 80° F.

Surface heat-transfer coefficients.- The average surface heat-transfer coefficient q was obtained by divid-

ing the heat input per hour by the product of the area of the total cooling surface and the difference between the average temperature of the cooling surface and the entering-air temperature.

A value of q for individual stations around each cylinder was obtained by dividing the heat input per square inch of total cooling area by the difference between the average surface temperature at each station and the entering-air temperature.

The calculated value of the over-all heat-transfer coefficient U was obtained from the equation

$$U = \frac{q}{s + t} \left[\frac{2}{a} \left(1 + \frac{w}{2 R_b} \right) \tanh aw' + s_b \right]$$

as derived in reference 2, where

$$a = \sqrt{\frac{2q}{kt}}$$

- U, over-all heat-transfer coefficient, B.t.u. per square inch base area per hour, per °F. temperature difference between the cylinder wall and the entering cooling air.
- q, surface heat-transfer coefficient, B.t.u. per square inch total surface area per hour, per °F. temperature difference between the average surface and the entering cooling air.
- q_l , local surface heat-transfer coefficient, B.t.u. per square inch total surface area per hour, per °F. local surface temperature difference between the surface and the entering cooling air.
- k, thermal conductivity of metal, B.t.u. per square inch, per °F. through 1 inch per hour (2.17 for steel).
- t, average fin thickness, inches.
- s, average space between fins, inches.
- w, fin width, inches.

w' , $w + \frac{t_t}{2}$, effective fin width.

t_t , fin-tip thickness, inches.

R_b , radius from center of cylinder to fin root, inches.

s_b , distance between adjacent fin surfaces at the fin root, inches.

PRECISION

Heat-transfer coefficients.— The maximum errors in the values of the heat-transfer coefficients occurred at the highest rates of the heat flow and are probably less than ± 4 percent for U and ± 5 percent for q . These values include inaccuracies in measuring the heat input and surface temperatures with allowance for small unaccounted heat interchange through the ends of the cylinders. Inaccuracies occurring in the temperature measurements at high rates of air flow were a chief source of error owing to the low temperature differences obtained in this condition. The range of average temperature differences between the cylinder wall and the entering air extended from 40° F. to 355° F.

Air speed.— The air-speed measurements are accurate to within 1 percent for speeds above 40 miles per hour, and within 3 percent below this speed.

Effect of building up cylinders from separate fins.— The practicability of using finely pitched finned cylinders is partly determined by the difficulty in manufacture. Integral steel cylinders having wide fins and a space between fins of less than 0.060 inch are very difficult to machine. For this reason the fins for the present tests were separately constructed and sweated together at the abutting shoulders that make the cylinder wall. With only radial and circumferential heat flow, such as is obtained with the guard-ring method of testing, there is little heat exchange through the soldered surfaces and tests have shown that the results obtained from cylinders constructed in this manner are practically the same as for integral cylinders.

HEAT-TRANSFER COEFFICIENTS

The local surface heat-transfer coefficients q_s are shown for the various cylinders in figures 4, 5, and 6. These coefficients are slightly different from the true coefficients owing to the circumferential heat flow caused by the temperature gradient existing around the cylinder. These coefficients, however, give comparative values of the heat-transfer distribution and by this means it is possible to compare the effectiveness of the various methods of directing the air over the cylinders.

Velocity surveys made between fins (reference 5) show that the velocity around a cylinder is a maximum at a position between 60° to 90° from the front. The curves in figures 4, 5, and 6 show that, with the exception of the 0.057 cylinder, the heat-transfer coefficient q_s was a maximum at the front of the cylinder where the air speed was somewhat lower than at the sides. This result may have been partly caused by the conduction of heat from the rear of the cylinder to the sides so that the heat transfer in these regions appeared deficient with respect to that at the front of the cylinder.

The shape of the curves in figures 4, 5, and 6 indicates that the chief effect of directing the cooling air over the cylinders with baffles or with the blower and jacket arrangement is to flatten out the sharp break in the q_s curves that is caused by the break-away of flow that occurs at the 90° position for cylinders tested in the free air stream. The shapes of the curves from tests with baffles and with blower cooling are practically the same. There is no consistent trend to show whether cooling in the baffle tests or in the tests with the blower produces the greater heat transfer at the rear of the cylinder.

Results from the wind-tunnel tests are given in figure 7 showing curves of the average q for each cylinder as well as curves of the over-all heat-transfer coefficient U . The corresponding data for the tests with blower cooling have been reported in reference 4 and, with the exception of the 0.083 cylinder which is included for comparison, are therefore omitted. The coefficient U , which is based on the wall area, has also been calculated by means of the equation previously referred to, using the values of q given in figure 7. The calculated and experimental values of U conform reasonably well.

Effect of baffles.— The curves in figure 7 show, with one exception, the marked increase in q and U obtained through the use of baffles. At an air speed of 150 miles per hour the baffles effect an increase in heat transfer of 44 percent for the 0.083 cylinder and 24 percent for the 0.111 cylinder. The results of tests on the 0.057 cylinder show that with this fin spacing very little improvement can be obtained by the use of baffles. However, in the tests of this report the air could flow freely around the exterior of the baffles and the pressure drop across the cylinder was very small as compared with that across the pressure-type baffles which are used on conventional engines. The higher velocity over the fins under the latter condition may appreciably improve the results on the 0.057 cylinder when tested with pressure baffles as compared with the results without baffles.

Effect of fin space.— The variation of average q with fin space s for cylinders tested in the tunnel with and without baffles is shown in figure 8. Previous tests (reference 2) showed that for the range of fin spacing tested at that time, the data, when plotted on logarithmic coordinates, could be represented by straight lines with a slope of 0.32. The earlier data were for fins of various shapes and sizes and the curves represented a fairly wide dispersion of points. With the extension of the data to smaller values of s the trend of the previous data is now more accurately established and the curves are seen to have a slope that decreases with increase in s . The slope of these curves is determined to a large extent by the rise in air temperature and by a decrease in the air velocity between fins as the fins are more closely spaced. The reduction in air velocity is caused by an increase in the resistance to flow between fins with decrease in fin space, whereas the available energy head from the tunnel air stream remains constant. This effect is indicated by the curves in figure 9 obtained by comparing the average velocity between fins when blower cooling was used with the tunnel air speed, both cases giving the same heat-transfer coefficient U . Although the curves in figure 9 are, strictly speaking, not true indications of the velocity between fins in the tunnel tests because of the effects of turbulence and of air-temperature rise, it is believed that the relative velocities shown are very good approximations.

MAXIMUM VALUES OF THE HEAT-TRANSFER COEFFICIENT

A successive reduction in fin space is accompanied by an increase in the coefficient U up to a maximum value, as shown by the curves in figure 10. These curves indicate a maximum heat transfer with a fin space of approximately 0.045 inch for all three methods of directing the air over the cylinders and with all but the lowest air speeds, for which the space is somewhat larger. In these curves the coefficient U is dependent on the fin dimensions and on the surface coefficient q . The fin-surface area varies inversely as the fin thickness and fin space and q is dependent almost entirely upon the character and velocity of the air flow over the surfaces. As the number of fins per inch and the fin area are dependent upon the fin thickness and fin width as well as the fin space, it may be shown that the fin space at which the curves in figure 10 reach maximum values will vary with the fin thickness and width. The maximum values of U for any desired fin thickness or fin width may be calculated from the theoretical equation and a curve of q against fin space.

Effect of change in flow pattern.— It is well known that a transition from turbulent to laminar flow is accompanied by a decrease in the heat transfer. The effect of a probable change in boundary-layer flow conditions may be illustrated by the tests with blower cooling if the assumption is made that the heat transfer or the characteristic flow over the surface of each fin of a cylinder having fins spaced relatively far apart remain constant as the fin space is decreased. If this assumption is made, then the difference between the calculated U curve obtained in this manner and the experimental heat-transfer curve of U represents the effect of change in flow pattern. This effect is shown in figure 11 as the difference between curves A and curves B or D, where curve B was derived from the experimental data of the blower tests based on the difference between the cylinder temperatures and the average air temperature and curve D was calculated from the experimental q from the blower tests, also based on the average air-temperature difference. Curve A was calculated by the use of a constant q obtained from curve B for a fin space of 0.131 inch. The curves show that, with the air speed given, a change in the flow pattern starts gradually with a fin space of between 0.055 and 0.070 inch and increases to what may be fully devel-

oped laminar flow with some fin space less than that for maximum heat transfer. That such a change in flow also occurs in the wind-tunnel tests is indicated by the curves in figures 5, 6, and 7 in the comparison between the results obtained with the 0.057-inch pitch cylinder and the cylinders having larger pitches. The tunnel tests were, however, unlike the blower tests in that the decrease in heat transfer was caused by the combined effect of change in air-flow characteristics and a reduction in air velocity between fins, whereas in the blower tests the average velocity between fins was held constant.

The tendency for the curves in figure 10 to reach maximum values at closer fin spacings as the air speed increased conforms to what would be expected if the maximum value is a function of the transition from turbulent to laminar flow. As the air speed increases the transition from turbulent to laminar flow occurs at a reduced fin space.

In the blower tests it has been shown that, although the average air speed between fins was maintained constant as the fins were successively spaced closer together, the heat transfer increased to a maximum value and then decreased rapidly with further change in fin space. In these tests it is evident then that the average velocity between fins is not necessarily a criterion of the heat transfer.

Effect of air-temperature rise.- In the blower tests it was possible to measure and to calculate the air-temperature rise. From these data the effect of air-temperature rise on U is shown in figure 11 as the difference between U based on the average air temperature difference around the cylinder (curve B) and U based on the inlet-air temperature difference (curve C). The curves show that the fin space at which U is a maximum is practically unaffected by an increase in the temperature of the air. Furthermore, the decrease in U caused by air-temperature rise is shown to become greater as the fin space is decreased. Since the amount of air-temperature rise is directly proportional to the length of any one flow path between fins, it is evident that in the application of closely spaced fins there is a definite advantage in making the flow paths as short as is practical. In addition, short flow paths offer less resistance to flow and therefore should permit cooling with lower pressure heads.

CONCLUSIONS

For the cylinders tested it may be concluded that:

1. The maximum values of the over-all heat-transfer coefficients U occurred with a fin space of approximately 0.045 inch in tests in a free air stream, with and without baffles, and also in tests with the air drawn over the cylinder by means of a blower. The change in the flow pattern is probably the most effective factor limiting the maximum heat transfer that can be obtained by decreasing the space between fins.

2. The fin space for maximum heat transfer decreased slightly with an increase in air speed within the range from 30 to 150 miles per hour.

3. The fin space at which the over-all heat-transfer coefficient U was a maximum was unaffected by rise in air temperature.

4. Baffles considerably improved the heat transfer of closely spaced fins provided the fin space was not appreciably less than that for maximum heat transfer.

5. The variation of q around the cylinder was approximately the same for cylinders cooled in the free air stream with baffles as when cooled in a jacket using a blower to draw the air through the jacket.

Langley Memorial Aeronautical Laboratory,
National Advisory Committee for Aeronautics,
Langley Field, Va., December 17, 1936.

REFERENCES

1. Taylor, C. Fayette, and Rehbock, A.: Rate of Heat Transfer from Finned Metal Surfaces. T.N. No. 331, N.A.C.A., 1930.
2. Biermann, Arnold E., and Pinkel, Benjamin: Heat Transfer from Finned Metal Cylinders in an Air Stream. T.R. No. 488, N.A.C.A., 1934.
3. Schey, Oscar W., and Rollin, Vern G.: The Effect of Baffles on the Temperature Distribution and Heat-Transfer Coefficients of Finned Cylinders. T.R. No. 511, N.A.C.A., 1934.
4. Schey, Oscar W., and Ellerbrock, Herman H., Jr.: Blower Cooling of Finned Cylinders. T.R. No. 587, N.A.C.A., 1937.
5. Brevoort, M. J., and Rollin, Vern G.: Air Flow Around Finned Cylinders. T.R. No. 555, N.A.C.A., 1936.

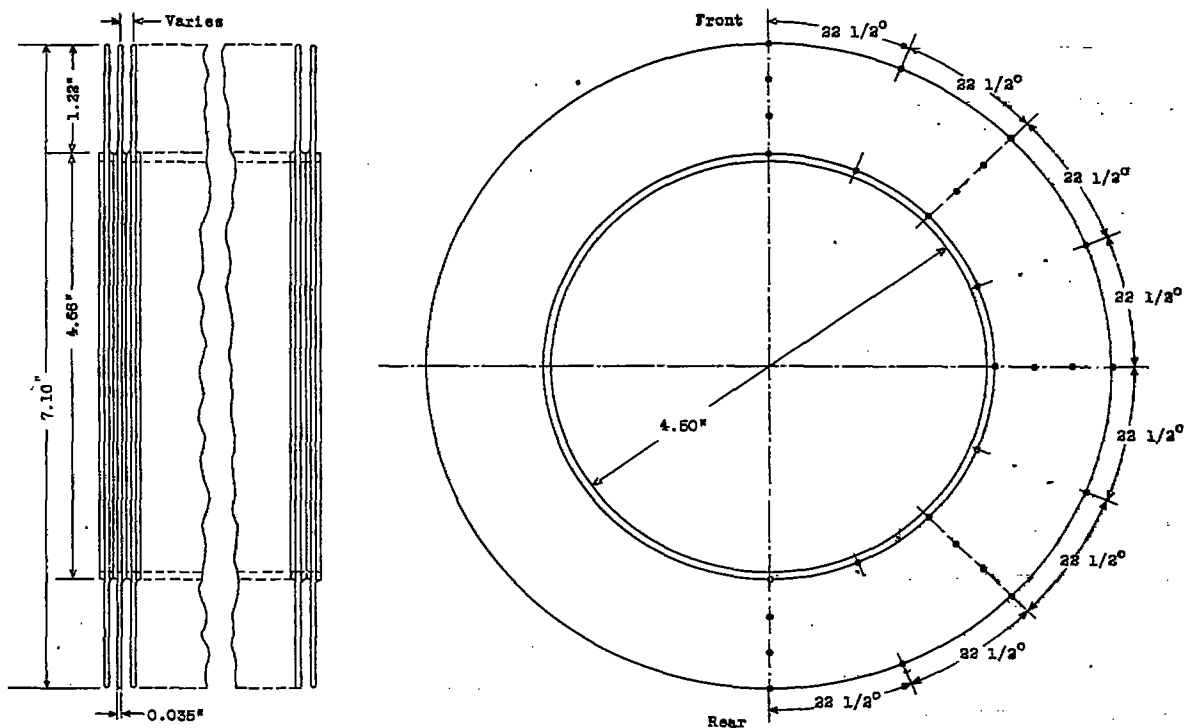

Figure 1.- Construction of finned cylinder and location of thermocouples.

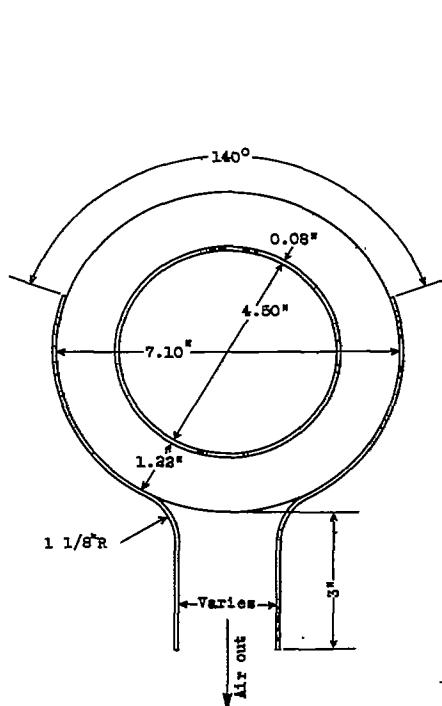

Figure 2.- Shape of baffles and location with respect to cylinder.

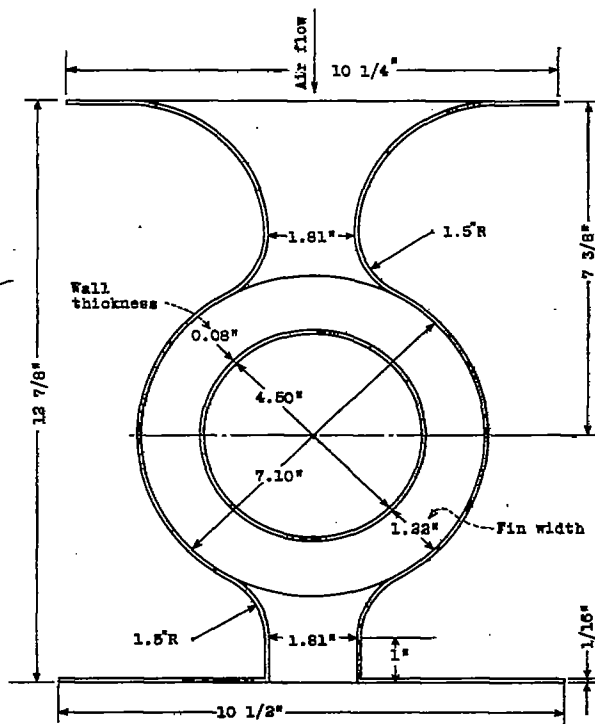

Figure 3.- Jacket for tests in which a blower was used to draw the cooling air over the cylinders.

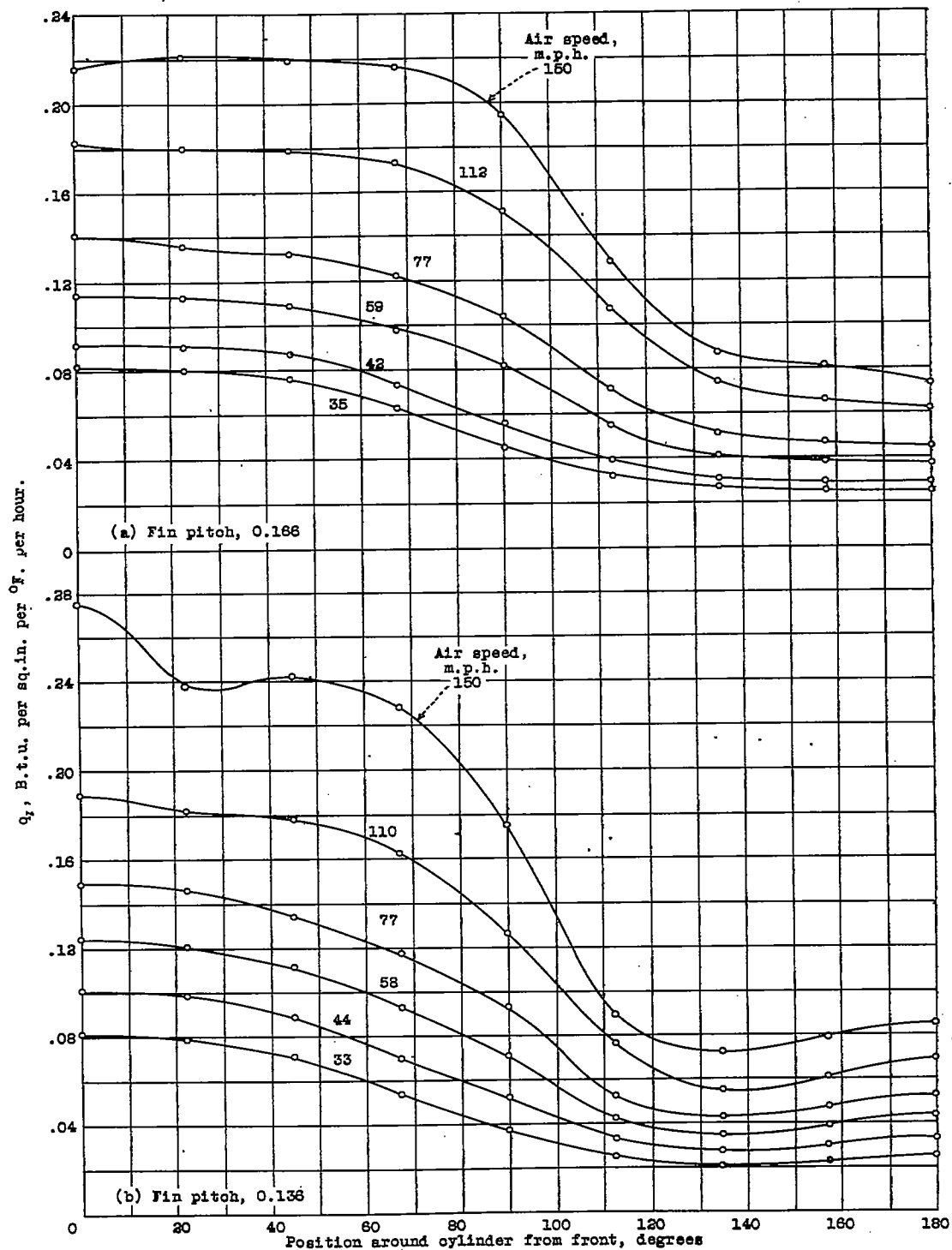

Figure 4a,b.- Variation of q_f with position around the cylinder when tested without baffles in the wind tunnel.

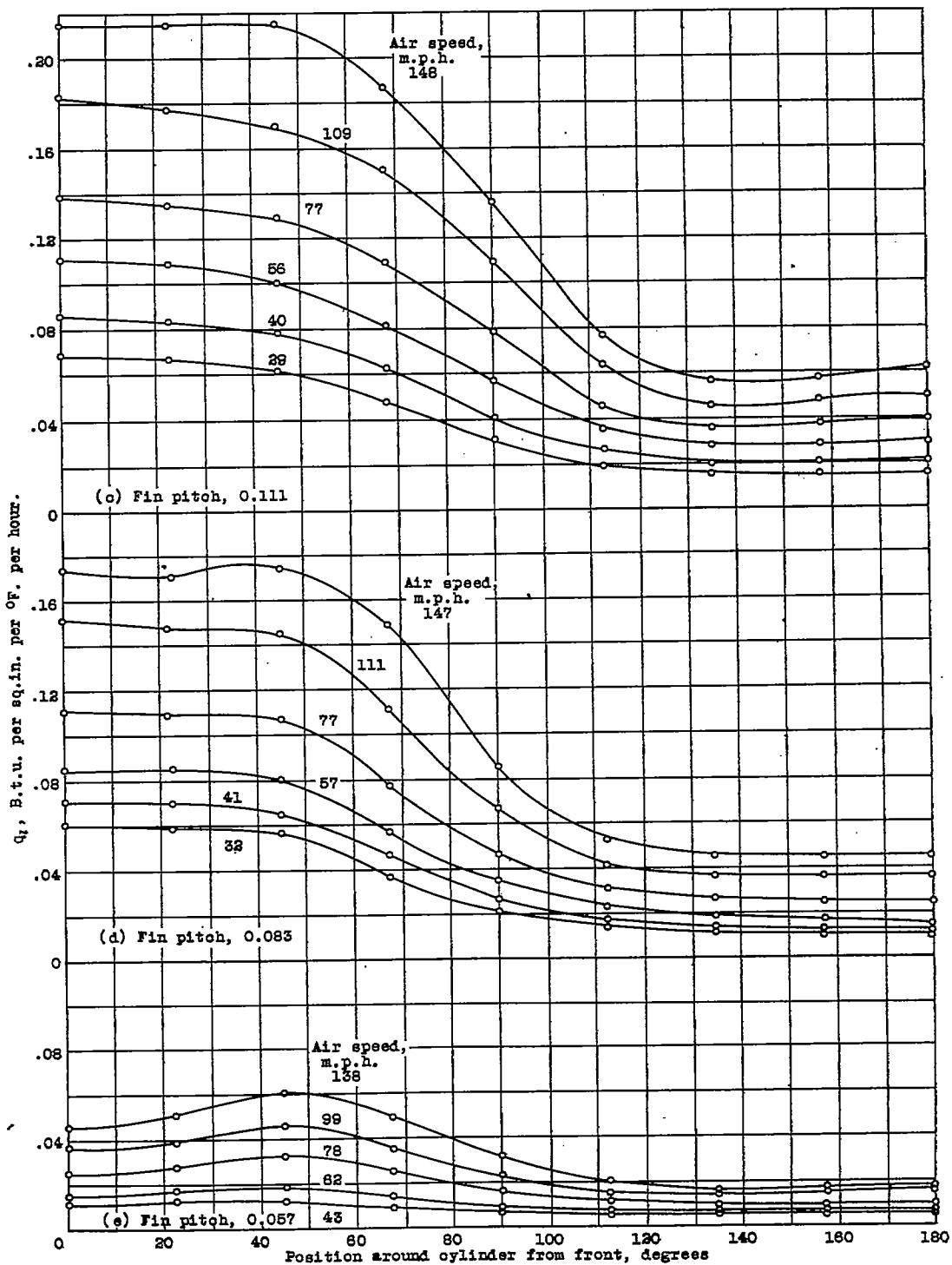

Figure 4c,d,e.- Variation of q_1 with position around the cylinder when tested without baffles in the wind tunnel.

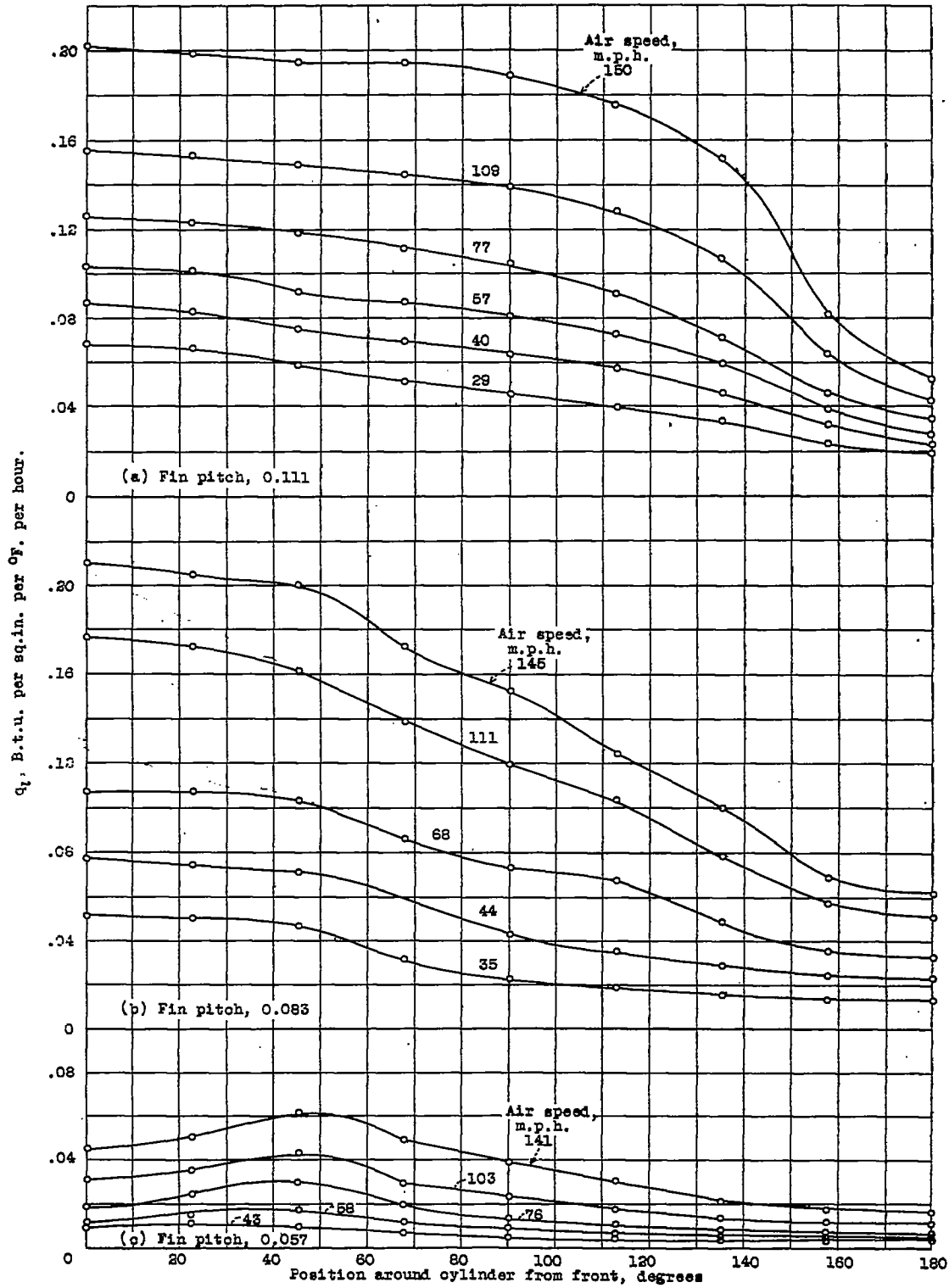

Figure 5a,b,c.- Variation of q_f with position around the cylinder when tested with baffles in the wind tunnel.

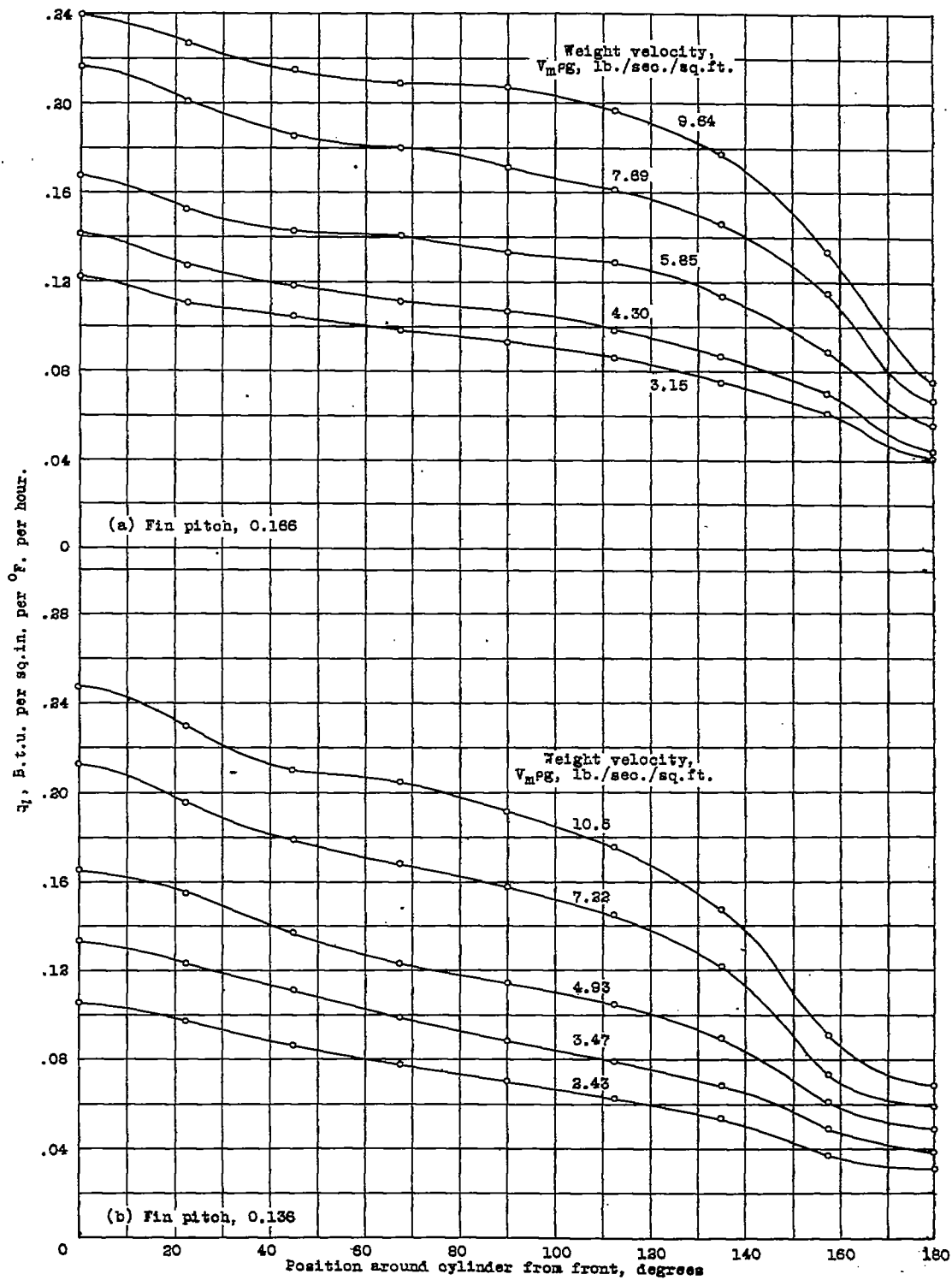

Figure 8a,b.- Variation of q_1 with position around the cylinder when tested in a jacket with blower cooling.

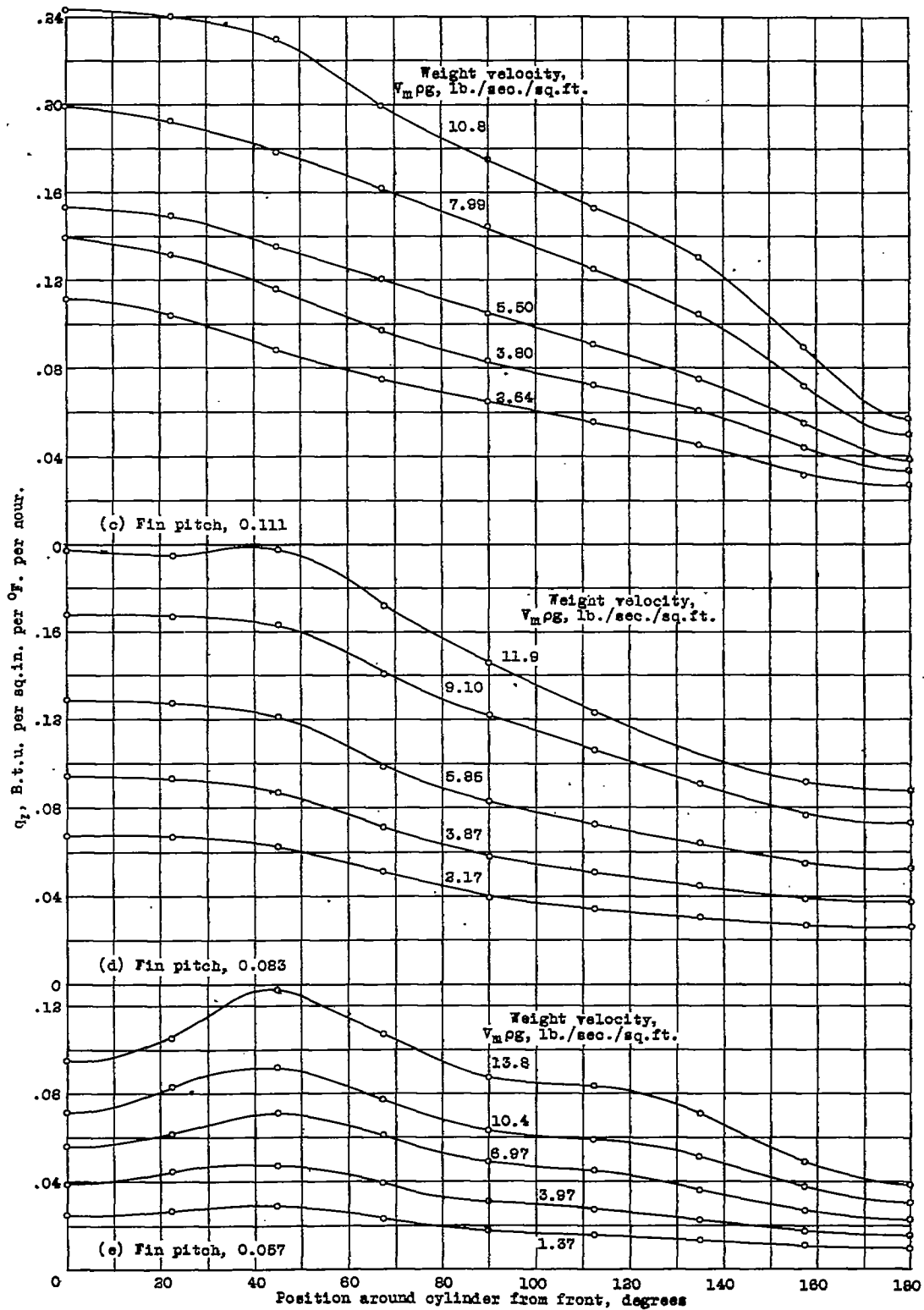

Figure 6c,d,e.- Variation of q_2 with position around the cylinder when tested in a jacket with blower cooling.

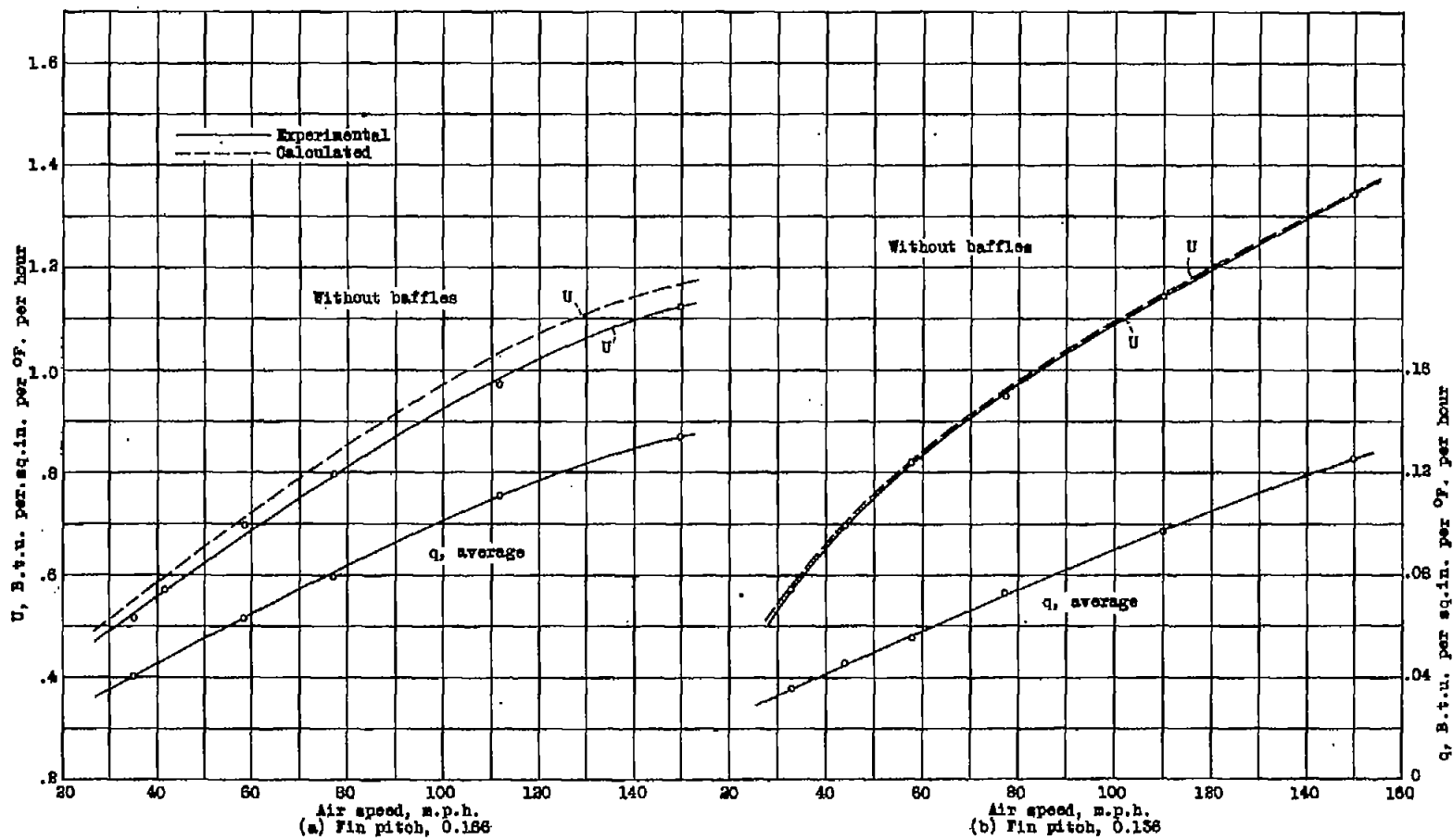

Figure 7a,b.- Variation of average q with air speed and comparison of calculated and experimental values of U.

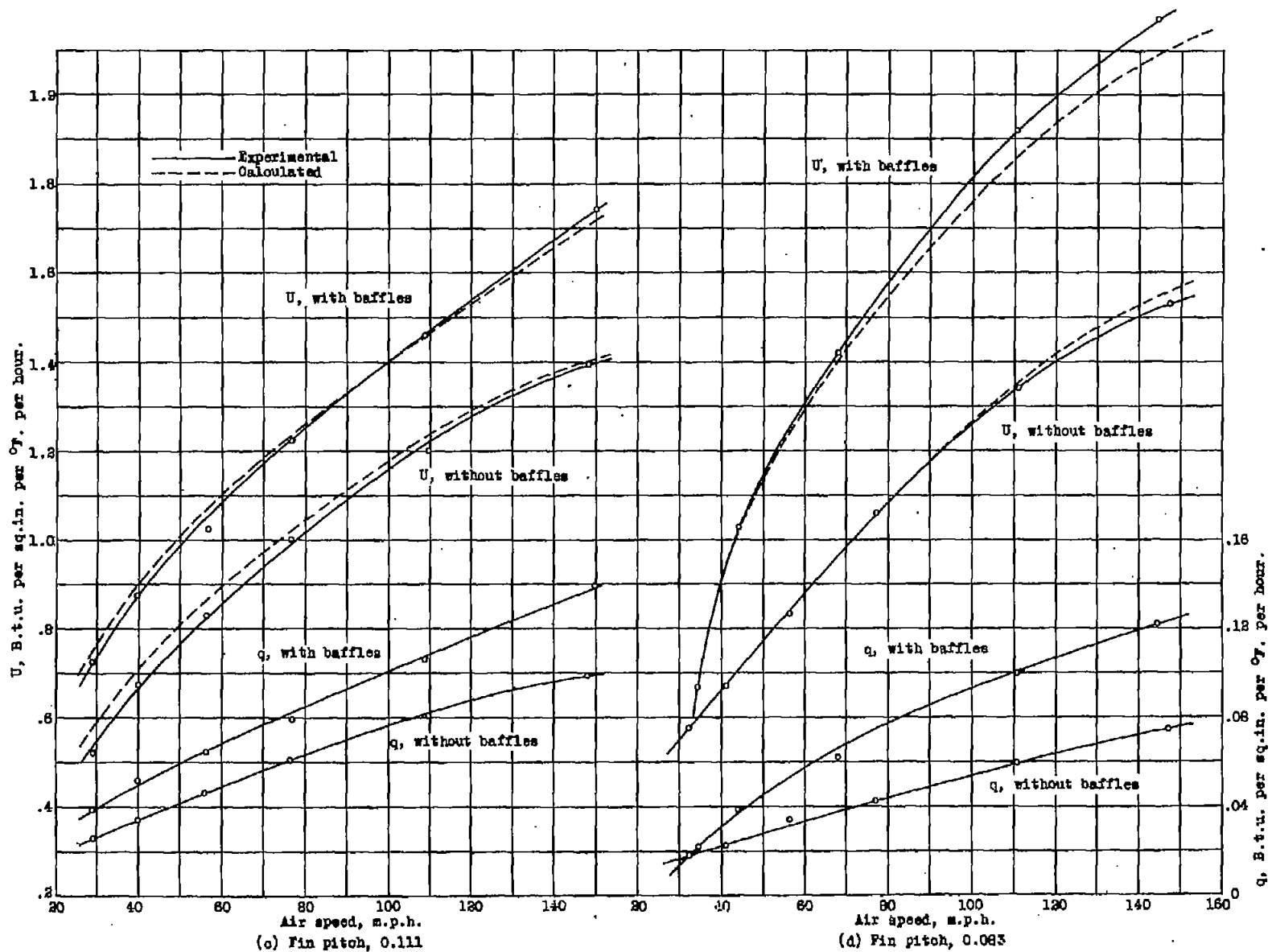

Figure 70,d.- Variation of average q with air speed and comparison of calculated and experimental values of U .

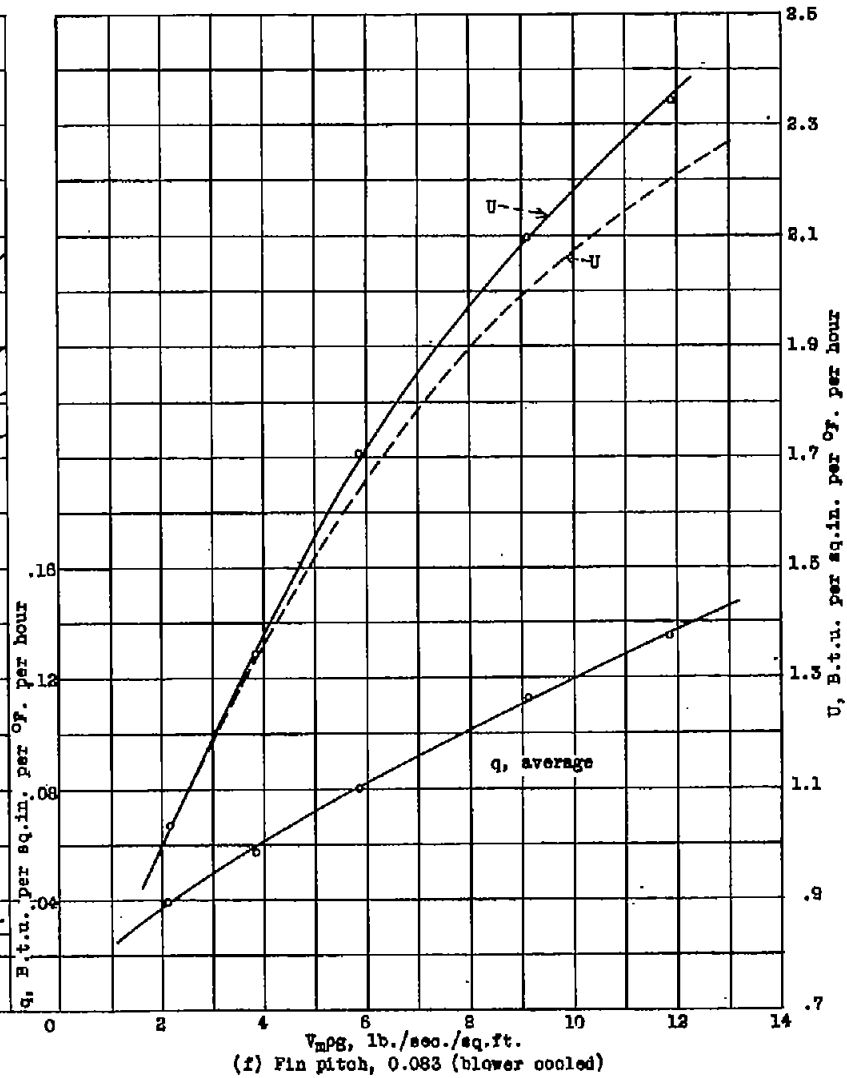
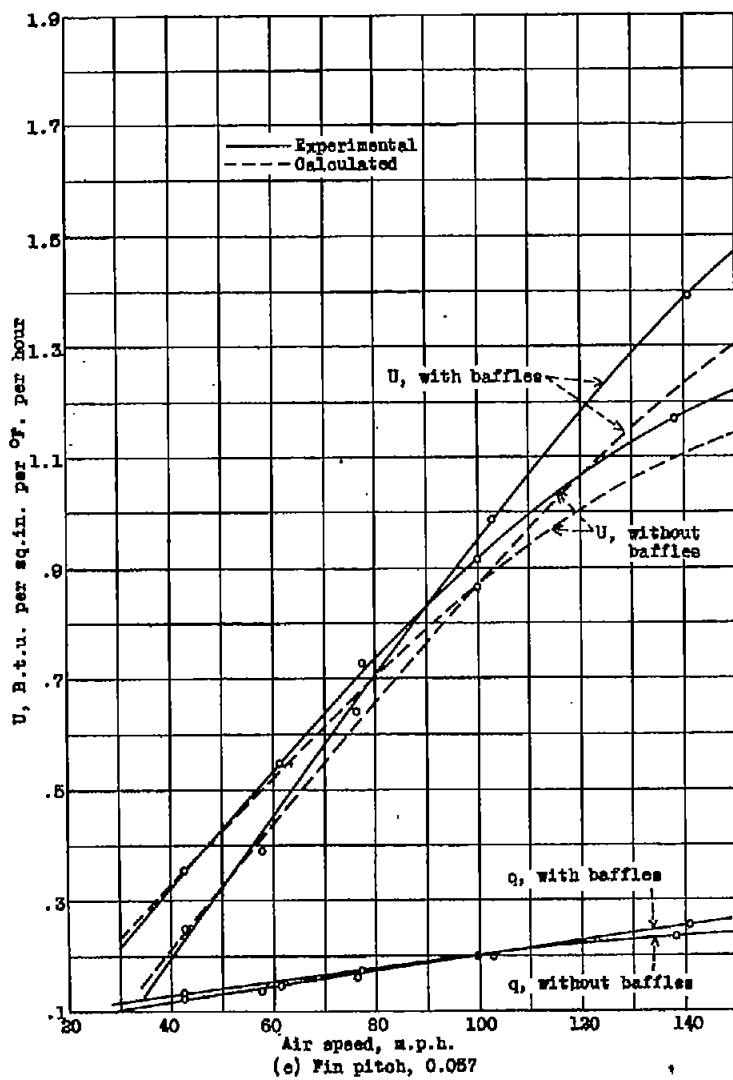

Figure 7e,f.- Variation of average q with air speed and comparison of calculated and experimental values of U .

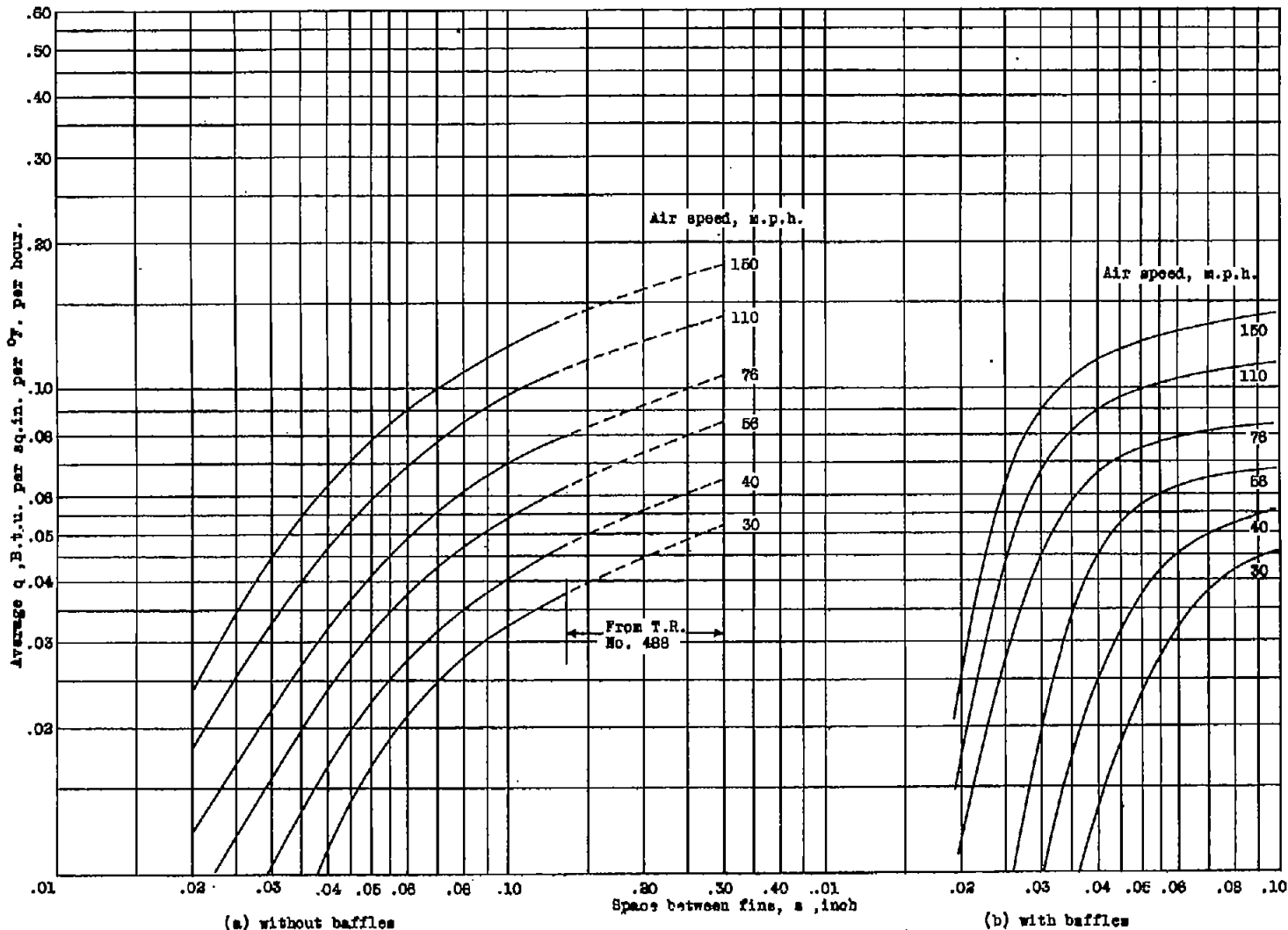

Figure 8a,b.- Effect of space between fins on the value of q for wind-tunnel tests.

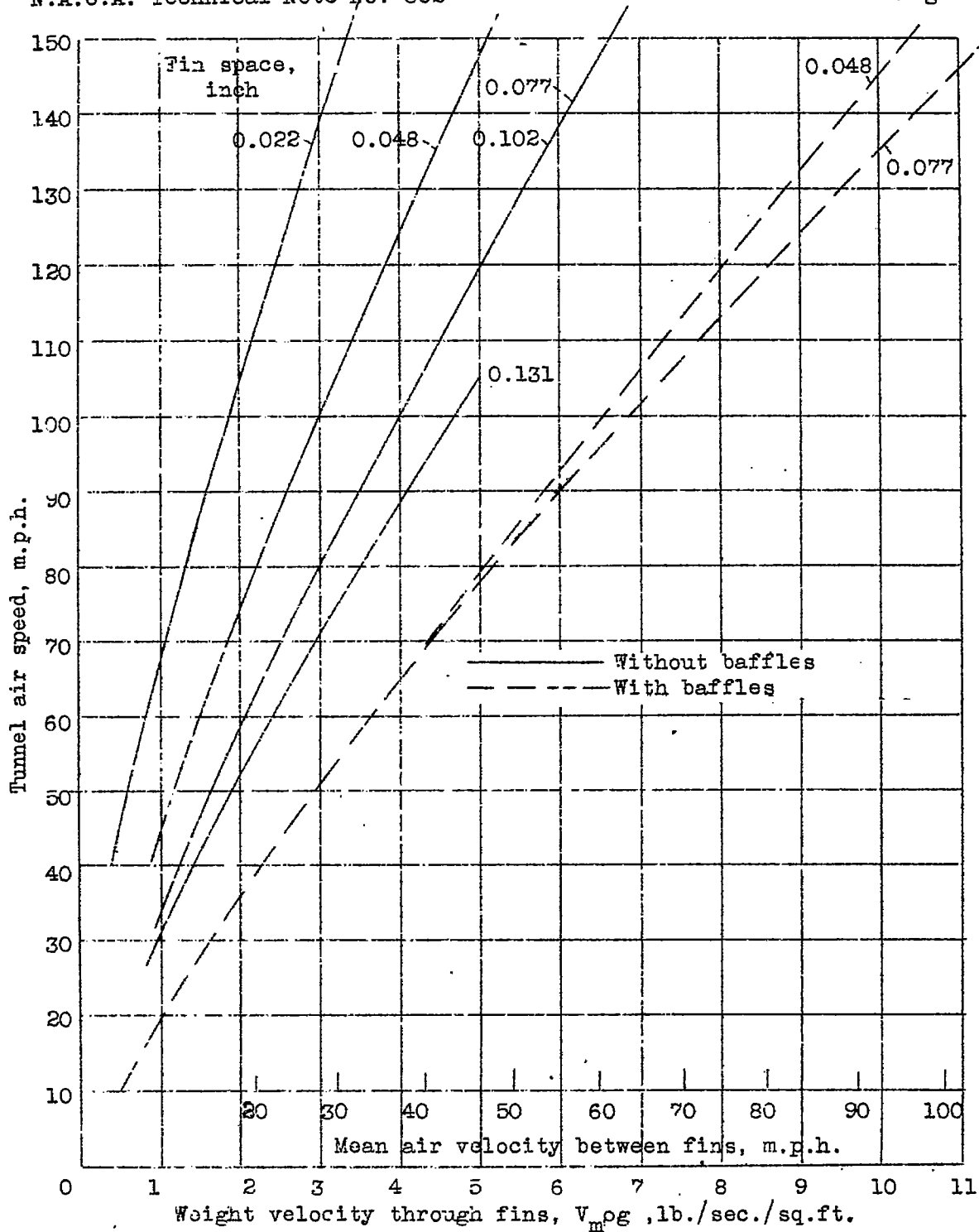

Figure 9.- Average velocity between fins with blower cooling compared with the tunnel velocity giving the same cooling.

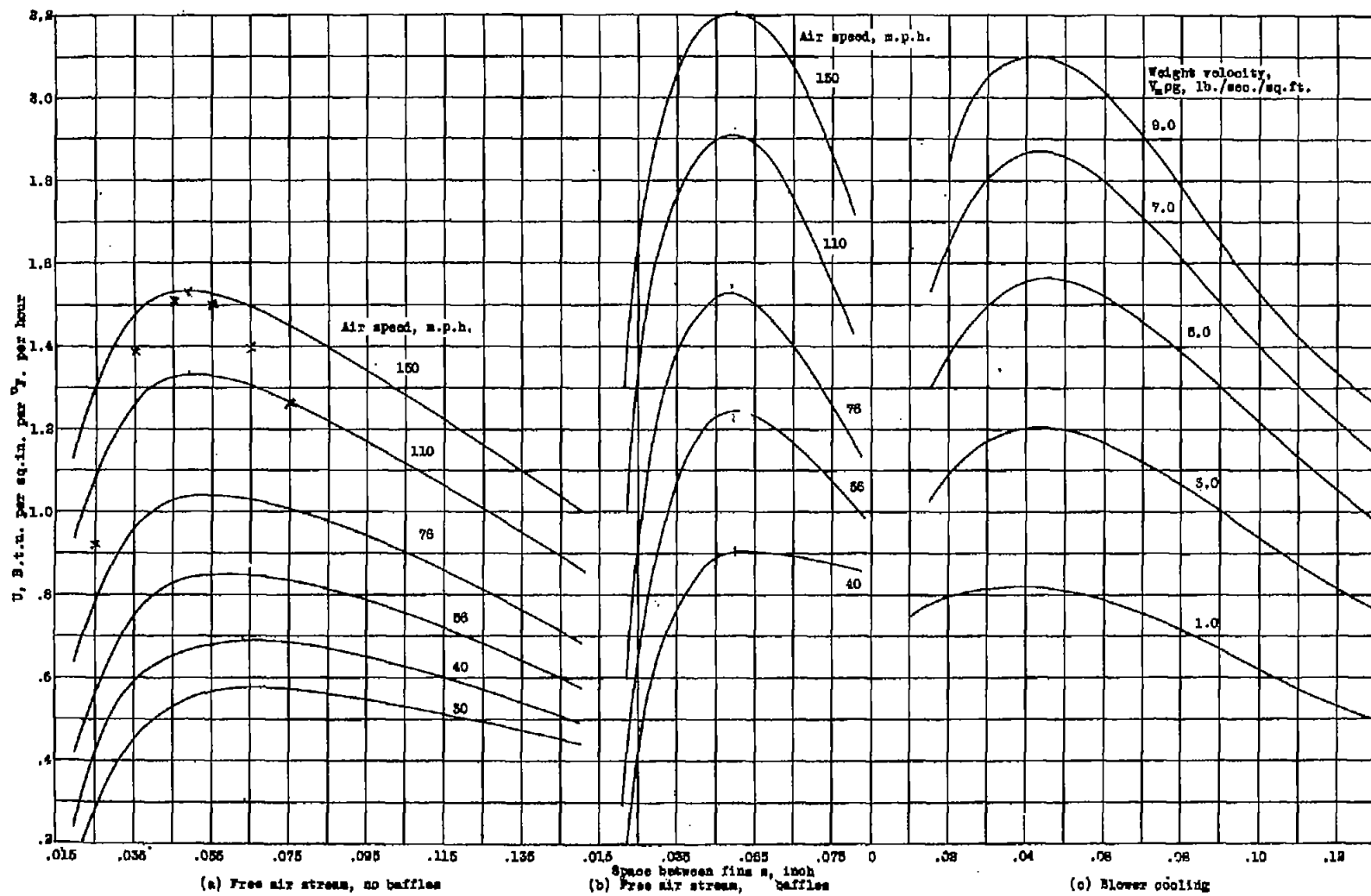

Figure 10a,b,c.- Variation of U with space between fins.

