



3 1176 00120 6243

6710
589
e.2

TECHNICAL NOTES

NATIONAL ADVISORY COMMITTEE FOR AERONAUTICS

MAR 2 1945

No. 543

THE COMPRESSIBILITY BURBLE

By John Stack
Langley Memorial Aeronautical Laboratory

LANGLEY MEMORIAL AERONAUTICAL
LABORATORY
Langley Field, VA.

Washington
October 1935

NATIONAL ADVISORY COMMITTEE FOR AERONAUTICS

TECHNICAL NOTE NO. 543

THE COMPRESSIBILITY BURBLE

By John Stack

SUMMARY

Simultaneous air-flow photographs and pressure-distribution measurements have been made of the N.A.C.A. 4412 airfoil at high speeds in order to determine the physical nature of the compressibility burble. The tests were conducted in the N.A.C.A. 24-inch high-speed wind tunnel. The flow photographs were obtained by the schlieren method and the pressures were simultaneously measured for 54 stations on the 5-inch-chord wing by means of a multiple-tube photographic manometer. Pressure-measurement results and typical schlieren photographs are presented.

The general nature of the phenomenon called the "compressibility burble" is shown by these experiments. The source of the increased drag is the compression shock that occurs, the excess drag being due to the conversion of a considerable amount of the air-stream kinetic energy into heat at the compression shock.

INTRODUCTION

The first important effects of compressibility were encountered in aeronautical applications when propeller tip speeds were increased to values approaching the velocity of sound. A marked decrease in propeller efficiency was noted and investigations were started to study the phenomenon. The earliest investigations were made on model propellers. These investigations were followed by tests of airfoils made partly to simplify experimental procedure so that the effects of compressibility could be more easily isolated and partly to develop sections more suitable for high-speed applications. The airfoil investigations indicated that a marked change in the type of flow occurred as the velocity of sound was approached; the lift decreased, the drag increased, and the center of pressure moved to the rear. Although these tests yielded much valuable informa-

tion for design problems, very little information regarding the character of the air flow, particularly at the compressibility burble, was obtained. It became apparent from these experiments that a more fundamental investigation was necessary to study the nature of the compressibility burble.

Preliminary experiments leading to the development of a method of flow visualization were undertaken early in 1934 and the schlieren method was adopted. The flow around the N.A.C.A. 0012 airfoil mounted in the 11-inch high-speed wind tunnel was observed and it was established (see fig. 3) that the flow change which occurred at the compressibility burble was associated with the formation of compression shocks or regions of rapid change of density in the flow. Following these observations, which were shown at the Ninth Annual N.A.C.A. Engineering Research Conference in May 1934, a general investigation of the air-flow variations over a wide speed range was outlined. This investigation consists of flow photographs and pressure measurements over the surface of a wing made simultaneously for several speeds extending from approximately 35 percent of the velocity of sound to values in excess of the speed at which the compressibility burble occurs. Part of this general investigation is reported herein and consists of simultaneous flow photographs and pressure-distribution measurements of the flow about an airfoil for speeds in the critical region, that is, for the speeds at which the flow breakdown or the compressibility burble occurs.

The experiments were conducted in the N.A.C.A. 24-inch high-speed wind tunnel. The airfoil on which observations were made is a 5-inch-chord N.A.C.A. 4412 airfoil with 54 orifices at the center section. The pressures at each orifice were simultaneously measured by means of a photorecording multiple-tube manometer.

APPARATUS AND METHODS

The N.A.C.A. 24-inch high-speed wind tunnel is an induction-type tunnel that may be operated over a large speed range. Compressed air from the variable-density wind tunnel discharged through an annular nozzle located downstream from the test section induces a flow of air from the atmosphere through the test section. Velocities approaching the velocity of sound may be obtained at the

test section. The tunnel is an outdoor wind tunnel and, except for certain modifications arising from this source and from its size, the methods of operation are the same as for the 11-inch high-speed wind tunnel (reference 1). The essential air passages are geometrically similar to those of the 11-inch high-speed tunnel. A cross-sectional diagram of the 24-inch high-speed tunnel is shown in figure 1.

The method of flow observation and photography is the schlieren, or striae, method devised by Toepler, which is described in detail in reference 2. A simplified diagram of the apparatus is given in figure 2. Light from a source located at C, the principal focus of lens D, emerges from the lens D as a parallel beam, passes through the converging lens D' and is brought to focus at E, the principal focus of lens D'. At E a knife-edge is located so as to cut off most of the light from the source C. The model A is placed in the parallel beam between the lenses and an image is formed on the screen F. When air passes over the model, its density, and therefore its optical index of refraction, changes. Thus, portions of the parallel beam of light are bent and some of the rays that were previously interrupted by the knife-edge now pass over the knife-edge at E to the screen or photographic plate F. The illumination on the screen then shows regions of varying air density.

The pressures over the airfoil were measured by means of a multiple-tube photorecording manometer. The manometer contains 60 tubes arranged in a semicircle with a neon light parallel to the tubes located at the center of the semicircle. Photostat paper is drawn from a roll, located at the back of the manometer, around the tubes and the exposed lengths of paper are drawn up on another roll also located at the back of the manometer. Mechanism for automatic remote control of the photostat paper and the light are contained within the manometer.

The model, a 5-inch-chord by 30-inch-span N.A.C.A. 4412 rectangular wing, consists of a brass center section of 1-inch span and duralumin end pieces. Fifty-four holes are arranged along the upper and lower surfaces at the center of the brass center section. These holes are connected to the manometer by small brass tubes led out through two large ducts cut in the lower surface of the duralumin end pieces of the model. The ducts are closed by duralumin covers shaped to the contour of the airfoil. The brass

center section and the duralumin end pieces are bolted together and all joints are carefully made to preserve the contour and fairness of the model.

Mounted for tests, the airfoil extended through the tunnel walls and was supported in carefully fitted transparent end plates. The model was originally designed for tests in the variable-density wind tunnel where the supporting system is such that the bending stresses at the center of the model resulting from lift loads are small. For the tests in the high-speed wind tunnel it was necessary to provide auxiliary bracing to care for the lift loads because of the inherent structural weakness of the airfoil at the center section. This bracing consisted of cables secured at the quarter-chord point of the airfoils approximately 6 inches out from the center on either side and fastened to the tunnel wall. These cables appear in some of the schlieren photographs as the dark lines extending outward from the airfoil approximately perpendicular to the lower surface; they should not be confused with the shock waves.

The lenses of the schlieren set-up were mounted, as shown by the simplified diagram (fig. 2). The source light was a high-intensity spark discharge and the photographs were obtained with a standard 8- by 10-inch studio-type camera. The camera was equipped with a shutter but no lens and, because of limitations in space within the tunnel chamber, it was necessary to mount a mirror back of the knife-edge of the schlieren apparatus to reflect the light from its original path into the camera. Because of the large change of pressure with time within the tunnel chamber as the air speed was increased from or decreased to zero, it was necessary to install methods of operating the tunnel and all the apparatus from the outside.

The test procedure consisted of first increasing the speed, by means of a motor-driven valve in the compressed-air supply line, to the desired value, which was measured by an outside mercury manometer connected to calibrated static plates. The camera shutter, which was operated by an electromagnet, was then opened and, at a signal immediately following, the light circuit for the manometer and the source light in the schlieren apparatus were closed. By this procedure the pressure record and the flow photograph were simultaneously obtained. The tunnel operator then quickly reduced the air speed to zero and closed the camera shutter. The film in the camera was changed, the

exposed photostat paper in the manometer was rolled up, a new section was automatically placed over the manometer tubes, and the procedure as previously outlined was repeated for the next speed.

Tests were made for each of three angles of attack, -2° , $-0^\circ 15'$, and $1^\circ 52\frac{1}{2}'$, for several speeds in the critical region.

For dynamic pressure $\frac{\rho}{2} V^2$ and the ratio of the local velocity to the local velocity of sound V/V_c , were determined by calibrated static-pressure orifices connected to two tubes in the photographic manometer and also to an outside mercury manometer, which was used to set the speed for the tests. A detailed discussion of the method of determining the dynamic pressure and the speed ratio V/V_c is given in reference 1. The pressures acting on the airfoil were determined by measuring the deflections of the liquid in the manometer tubes as shown on the photorecord; the ordinates for the pressure-distribution diagrams were computed by dividing these pressures by $\frac{\rho}{2} V^2$ as determined by the static-pressure orifices in the tunnel walls and the tunnel calibration.

DISCUSSION

Investigations of the effects of air compressibility on the characteristics of propellers and airfoils have indicated that a marked change in the type of air flow occurs as the air speed approaches the velocity of sound. This flow change, or compressibility burble, is evidenced by large detrimental changes in the characteristics of airfoils. Previous tests (e.g., references 1 and 3) have shown that the critical speed, that is, the speed at which the compressibility burble occurs, decreases as the lift increases. Because of the relationship between the lift and the induced velocities over the surface of an airfoil, the dependence of this critical speed on lift is important in that it shows that the speed at which the compressibility burble occurs is influenced by the induced velocities in the field of flow. Analysis of the force-test and other data (reference 1) indicated that the compressibility burble occurs when the local velocity at any point in the field of flow reaches the local velocity of sound. Fundamental knowledge of the compressibility burble, however,

cannot be obtained from force-test data alone; and, in order to determine the nature of the phenomenon, it was necessary to obtain air-flow observations and pressure-distribution data.

Preliminary flow observations made of the N.A.C.A. 0012 airfoil in the 11-inch high-speed wind tunnel definitely showed the establishment of compression shocks in the flow about the airfoil when the main stream velocity was considerably less than the velocity of sound. The results of these observations correlated with force tests (fig. 3) showed that the rise in drag occurs simultaneously with the establishment of the compression shocks. As the speed of flow is increased to values approaching the velocity of sound, a shock appears first near the leading edge of the airfoil and then moves aft with further increase of speed, ultimately reaching the trailing edge. The abrupt increase in drag starts with the first appearance of the shock and continues as the shock moves aft along the airfoil. The location of the shock on the N.A.C.A. 0012 airfoil when the speed is approximately 76 percent of the velocity of sound is shown by the sketch at the top of figure 3. The photographs in the figure show the position and width of the discontinuity at slightly higher speeds. As the compression shock moves aft along the airfoil the front remains approximately perpendicular to the air-flow direction as shown in the lower photograph. The upper photograph shows the shock at the trailing edge and the considerable downstream slope of the discontinuity indicates that supersonic velocities exist in the region ahead of the shock.

The results of the pressure-distribution tests (figs. 4, 5, and 6) and the simultaneous schlieren photographs, typical results of which are presented in figures 7, 8, 9, and 10, provide the fundamental information leading to a complete description of the phenomenon as well as corroborate the preliminary observations and the earlier force tests. The dotted lines on the pressure-distribution diagrams are drawn at ordinate values corresponding to the local velocity of sound. It is apparent, then, from examination of the diagrams that local velocities considerably in excess of the local velocity of sound are attained over the forward portion of the airfoil. This region of supersonic velocities ends in the compression shock, which is evidenced on the pressure-distribution diagram by the discontinuity in the curves and the relatively large and abrupt increase of pressure. Comparison of the schlieren photographs and the pressure-distribution diagrams (e.g.,

fig. 4 with figs. 7 and 8) shows that the location of the shock at the various speeds as determined by both methods is in agreement. The width of the shock at the highest speeds, as shown by the photographs, is relatively narrow, and it is likely that the entire increase in pressure occurs in this region. At lower speeds (see figs. 4 and 8, $V/V_c = 0.668$) the discontinuity extends over a relatively wide area along the airfoil and seems to consist of a series of less intense discontinuities. It is important to note that, when this condition exists, the resultant velocities over that portion of the airfoil are very close to the velocity of sound and that the corresponding air-stream velocity is the velocity at which the compressibility burble starts.

The results of the pressure-distribution investigation corroborate the preliminary flow observations as regards the movement of the shock with change of speed. A comparison of figures 7 and 8 shows that the shock moves forward as the speed is decreased and an examination of the pressure-distribution diagrams for any angle of attack likewise shows the forward movement of the region of discontinuity with decrease of speed. This condition exists irrespective of angle of attack. The shock, however, may not occur the same distance back of the leading edge on both upper and lower surfaces because of differences in the pressure distribution for the two surfaces.

The decrease in the speed at which the compressibility burble occurs as the lift is increased is also substantiated by the pressure-distribution data. When the angle of attack is $1^\circ 52\frac{1}{2}'$, the compressibility burble is just starting at a speed ratio V/V_c of 0.596 (fig. 6). The corresponding condition at -2° occurs for a speed ratio of 0.668 (fig. 4). It is also apparent that the discontinuity on the lower surface shown by the results for an angle of attack of -2° (figs. 4, 7, and 8) does not occur at the highest angle of attack except at the highest speed (fig. 6). With further increase of angle of attack the discontinuity on the lower surface will entirely disappear.

It is not the purpose of this preliminary report to give a detailed analysis of the discontinuity but, in view of its importance in certain applications, it is desirable to consider briefly the conditions leading to the establishment of the shock. As flow velocities approach the velocity of sound, the sum of the main flow velocity

and the induced velocity near the surface of the airfoil exceeds the local velocity of sound. The existence of this supersonic-velocity region is shown by the pressure-distribution diagrams. The flow conditions are now quite unlike the conditions at low speeds because the velocity at which pressures are propagated is the velocity of sound. This fact is particularly significant because pressures in the subsonic-velocity field existing at the rear of the airfoil cannot be transmitted upstream to affect the pressure field corresponding to the supersonic velocities that exist over the forward portion of the airfoil. It is apparent, then, that an unusual type of flow must exist since the air after passing through the supersonic-velocity region must be retarded to subsonic velocities. The nature of the observed discontinuity where this retardation takes place is illustrated by the schlieren photographs, and the flow phenomena are described by the pressure-distribution data.

Similar discontinuities have been observed in converging-diverging nozzles operating with excessive back pressure. A discussion of the phenomenon in nozzles is given in reference 4 and a theoretical analysis of the infinitely thin discontinuity or shock wave is given in reference 5. Prandtl has derived a formula (reference 4, p. 84) for the increase of pressure at the shock. Pressure increments computed from this formula (reference 6), however, give values much larger than the values obtained by the present experiments and some doubt may therefore exist as to the adequacy of the analysis. Furthermore, this analysis does not permit the prediction of the location of the shock for any given speed.

One significant result of the analyses presented in references 4 and 5, however, concerns the change of state of the air or gas passing through the discontinuity. It has been shown (reference 4) that the air passes through the discontinuity and undergoes an increase of entropy. The cause of the drag increase can thereby be readily explained. Low-pressure, high-kinetic-energy air meets the discontinuity where there is a sudden decrease in kinetic energy. Only part of this kinetic energy is recovered as a gain in pressure; the remainder is converted into heat and is lost to the flow. This loss of kinetic energy to the flow appears as increased drag or, conversely, the additional energy required to propel an object at a speed above that at which the compressibility burble occurs, in excess of the energy required if no change of flow occurred, is converted into heat energy.

Some further experimental investigation may be required to enable the solution of certain quantitative aspects of the problem, notably the computation of the pressure after the shock and the prediction of the location of the wave on the surface for any given speed.

CONCLUSIONS

1. The general nature of the phenomenon called the "compressibility burble" has been determined. It has been established that as the free-stream speed approaches the velocity of sound the air in passing over the airfoil surface is accelerated to speeds in excess of the local velocity of sound and, when this condition occurs, a compression shock is formed that involves a more or less sudden, rather than a gradual, retardation of the flow and a dissipation of energy.

2. The source of the increased drag observed at the compressibility burble is the compression shock and the excess drag is due to the conversion of a considerable amount of the air-stream kinetic energy into heat at the compression shock.

3. Although the experiments disclose the general nature of the compressibility burble, certain quantitative aspects of the phenomenon require further experimental investigation and analysis.

Langley Memorial Aeronautical Laboratory,
National Advisory Committee for Aeronautics,
Langley Field, Va., September 23, 1935.

REFERENCES

1. Stack, John: The N.A.C.A. High-Speed Wind Tunnel and Tests of Six Propeller Sections. T.R. No. 463, N.A.C.A., 1933.
2. Wood, Robert W.: Physical Optics. The Macmillan Company, New York, 1919.
3. Stack, John, and von Doenhoff, Albert E.: Tests of 16 Related Airfoils at High Speeds. T.R. No. 492, N.A.C.A., 1934.
4. Stodala, A.: Steam and Gas Turbines, vols. I and II. (Authorized translation from the sixth German edition by Louis C. Lowenstein.) McGraw-Hill Book Company, Inc., 1927.
5. Taylor, G. I., and Maccoll, J. W.: The Mechanics of Compressible Fluids. Vol. III, div. H of Aerodynamic Theory, edited by William Frederick Durand, Julius Springer (Berlin), 1935.
6. Jacobs, Eastman N.: Methods Employed in America for the Experimental Investigation of Aerodynamic Phenomena at High Speeds. Prepared for presentation at Volta meeting, Royal Academy of Italy, September 30, to October 6, 1935.

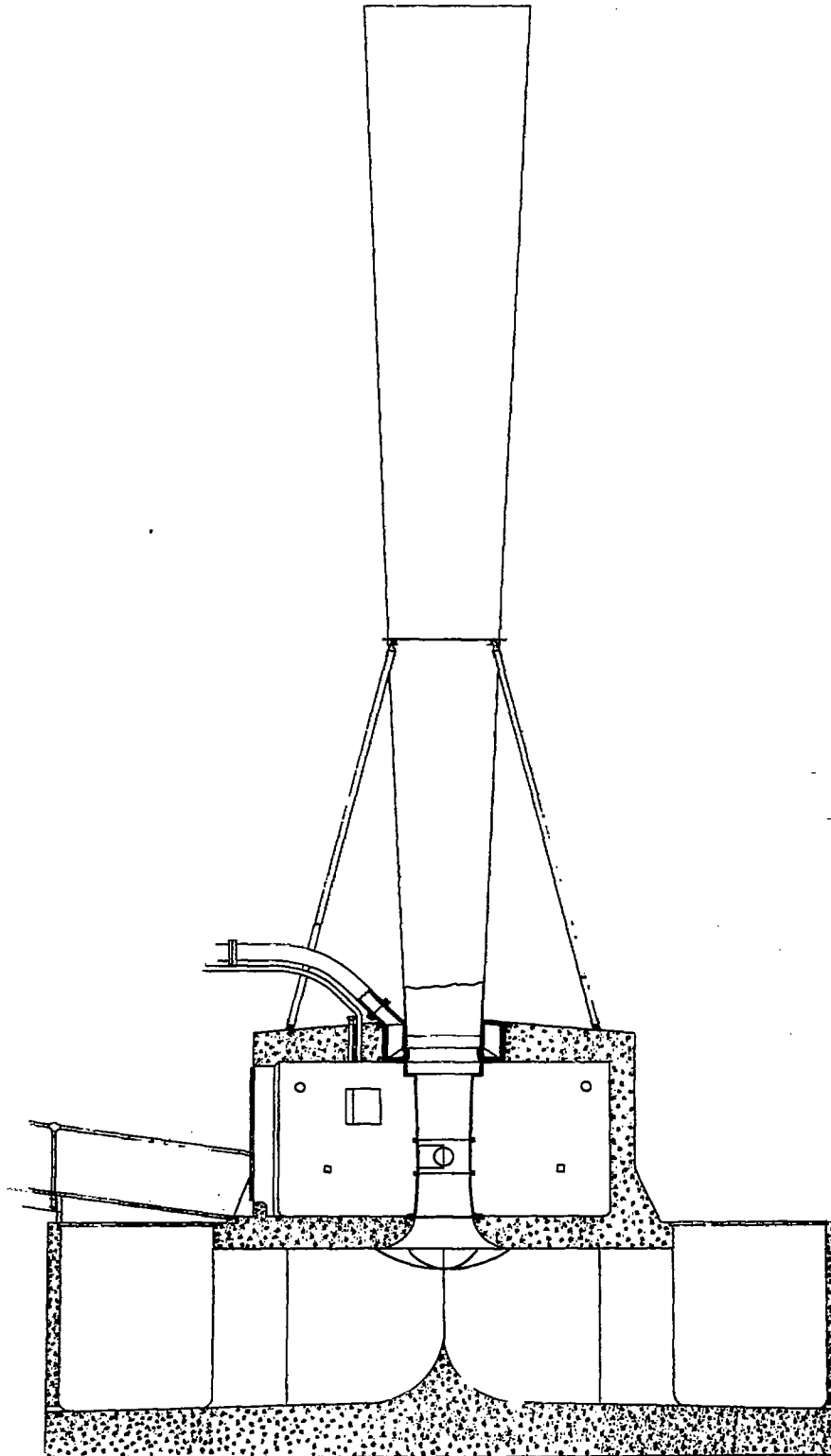

Figure 1.- Diagrammatic cross section of the N.A.C.A. 24 inch high-speed wind tunnel.

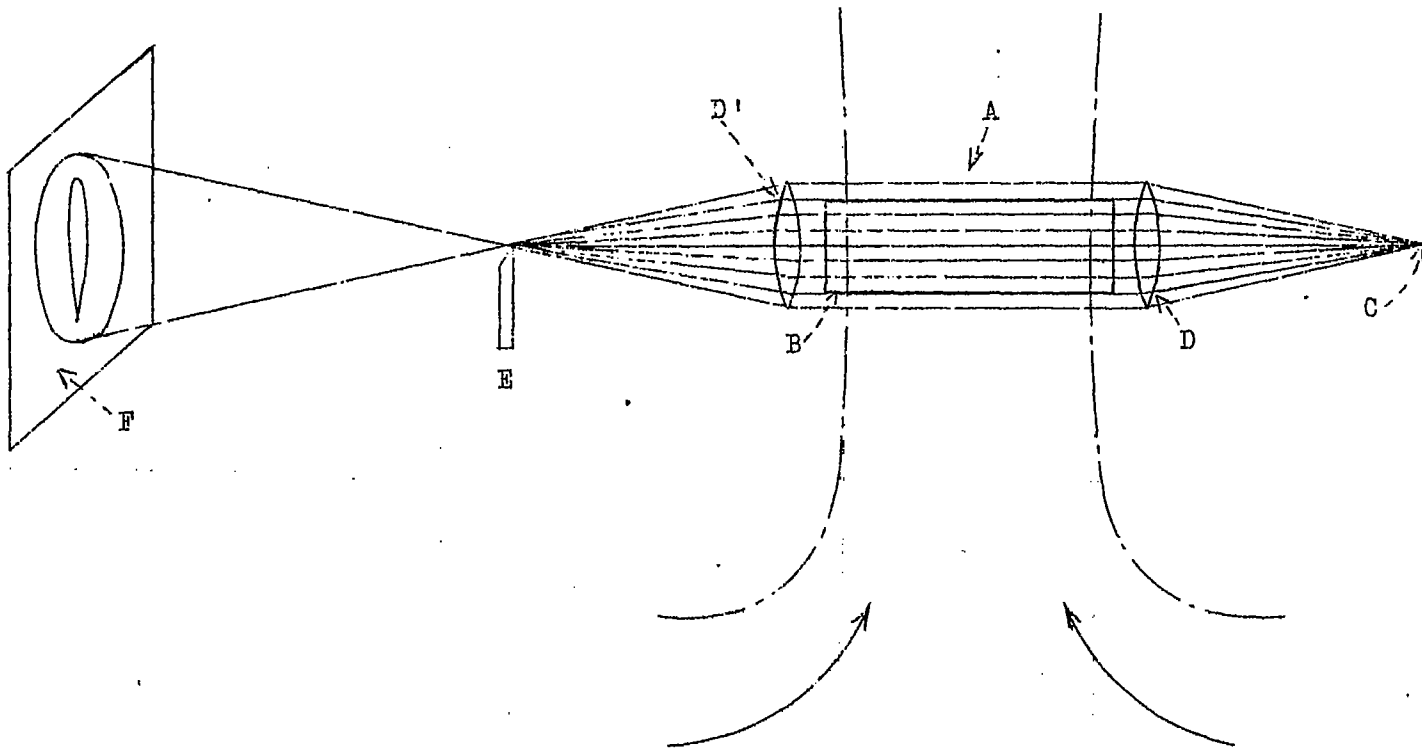

Figure 2.- Simplified diagram showing the schlieren method.

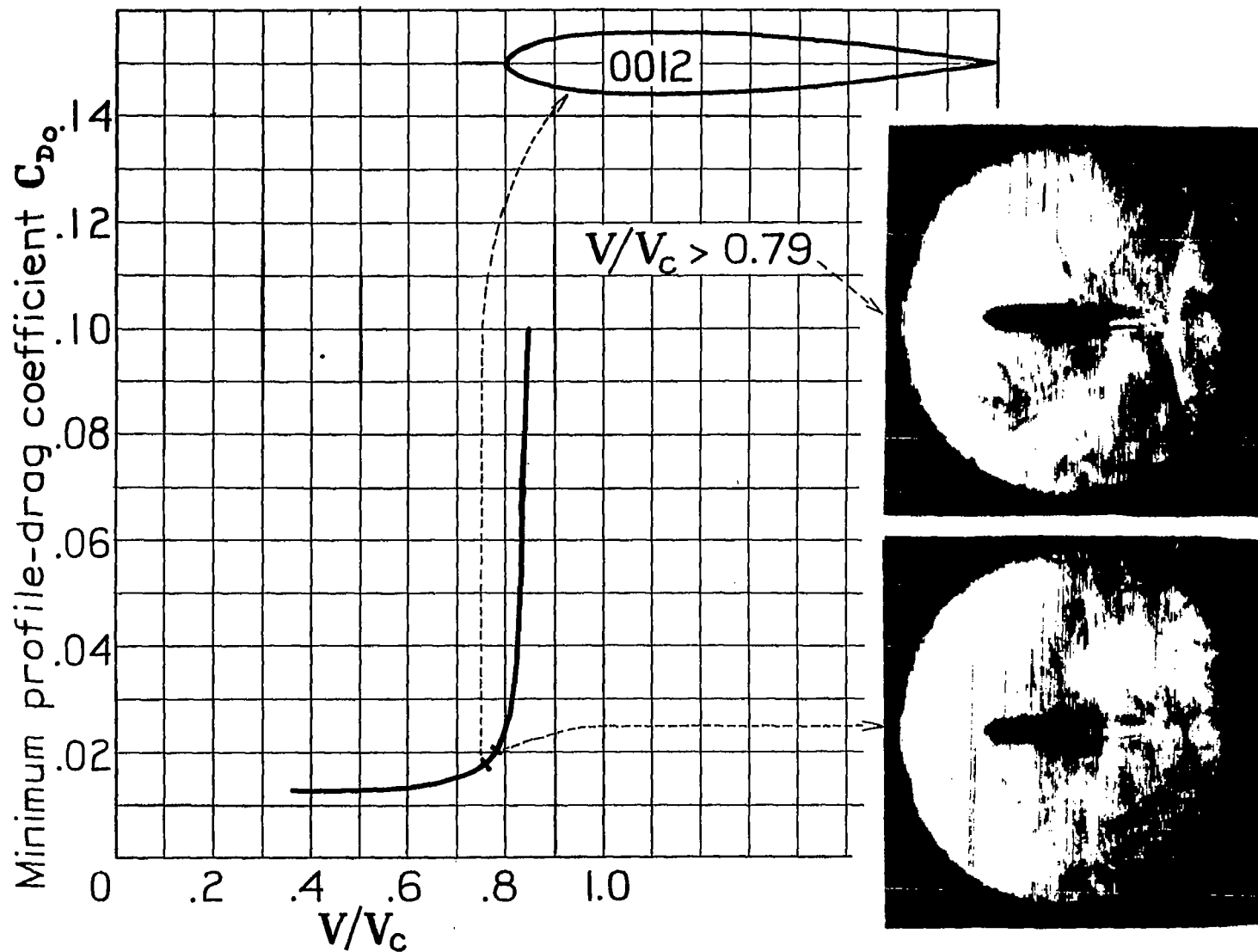

Figure 3.- Correlation of force tests and schlieren observations at the compressibility burble.

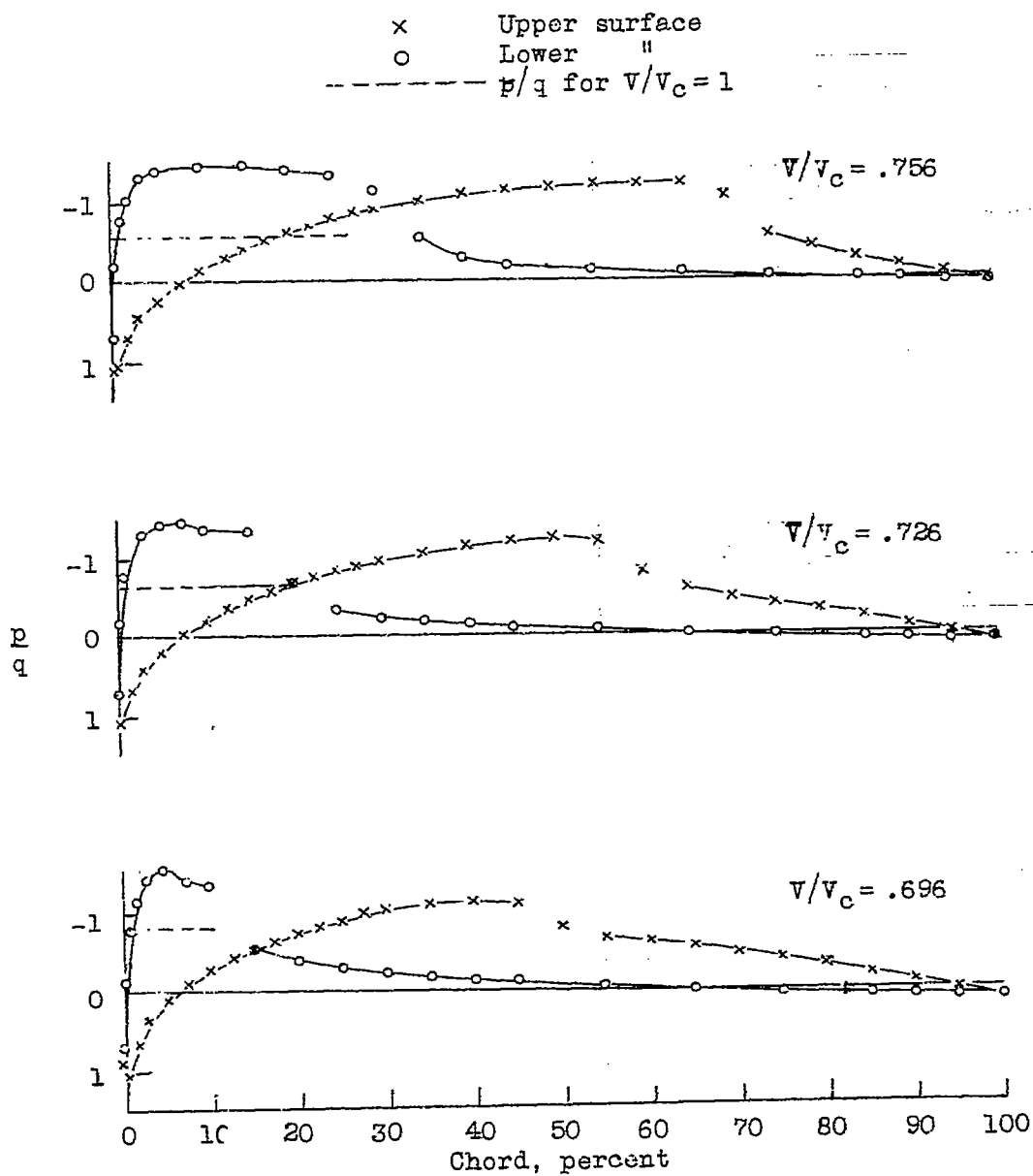

Figure 4.- Pressure distribution for N.A.C.A. 4412
 airfoil. $\alpha = -2^\circ$
 (Continued on next page)

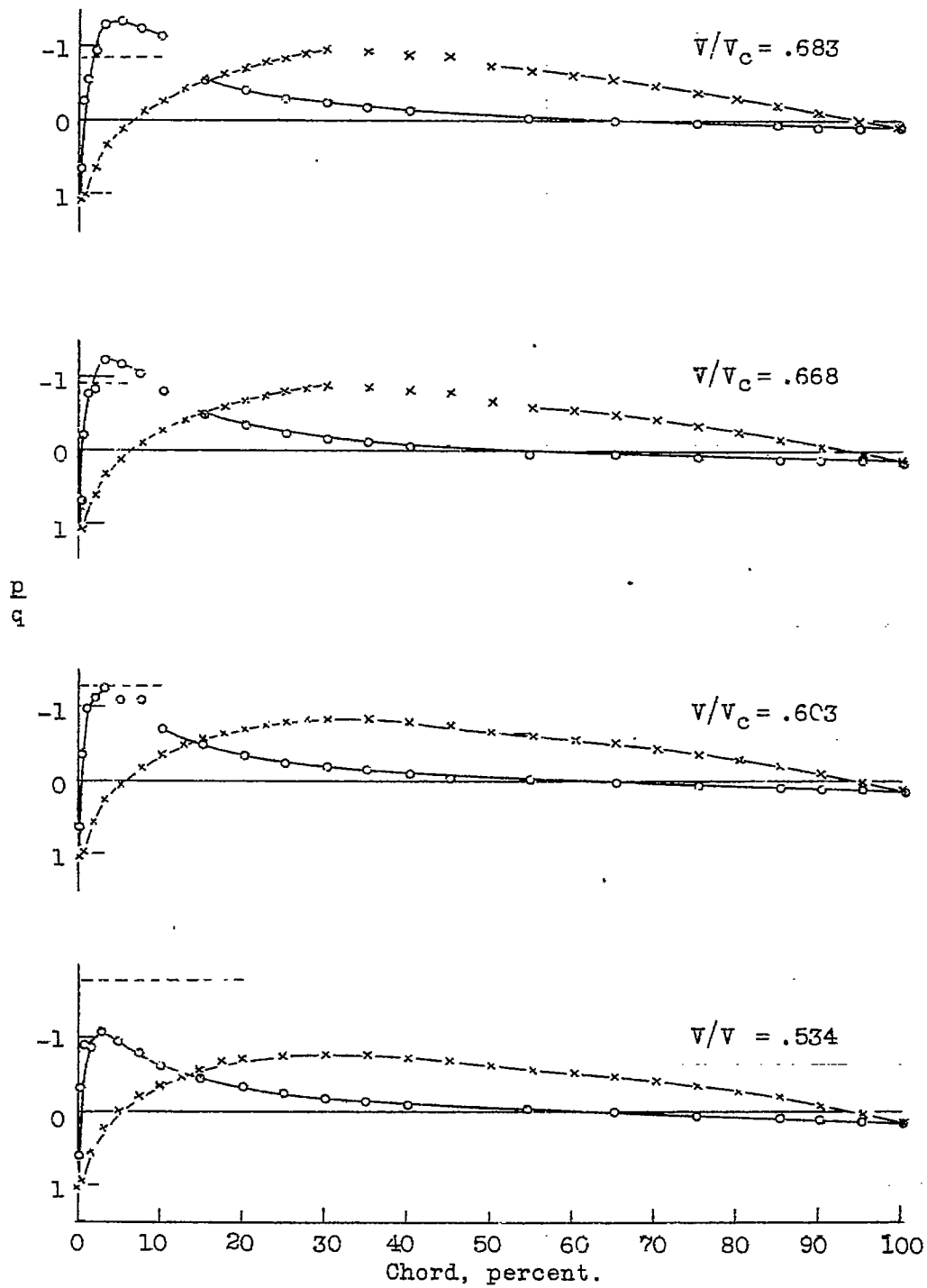

Figure 4. (concluded)

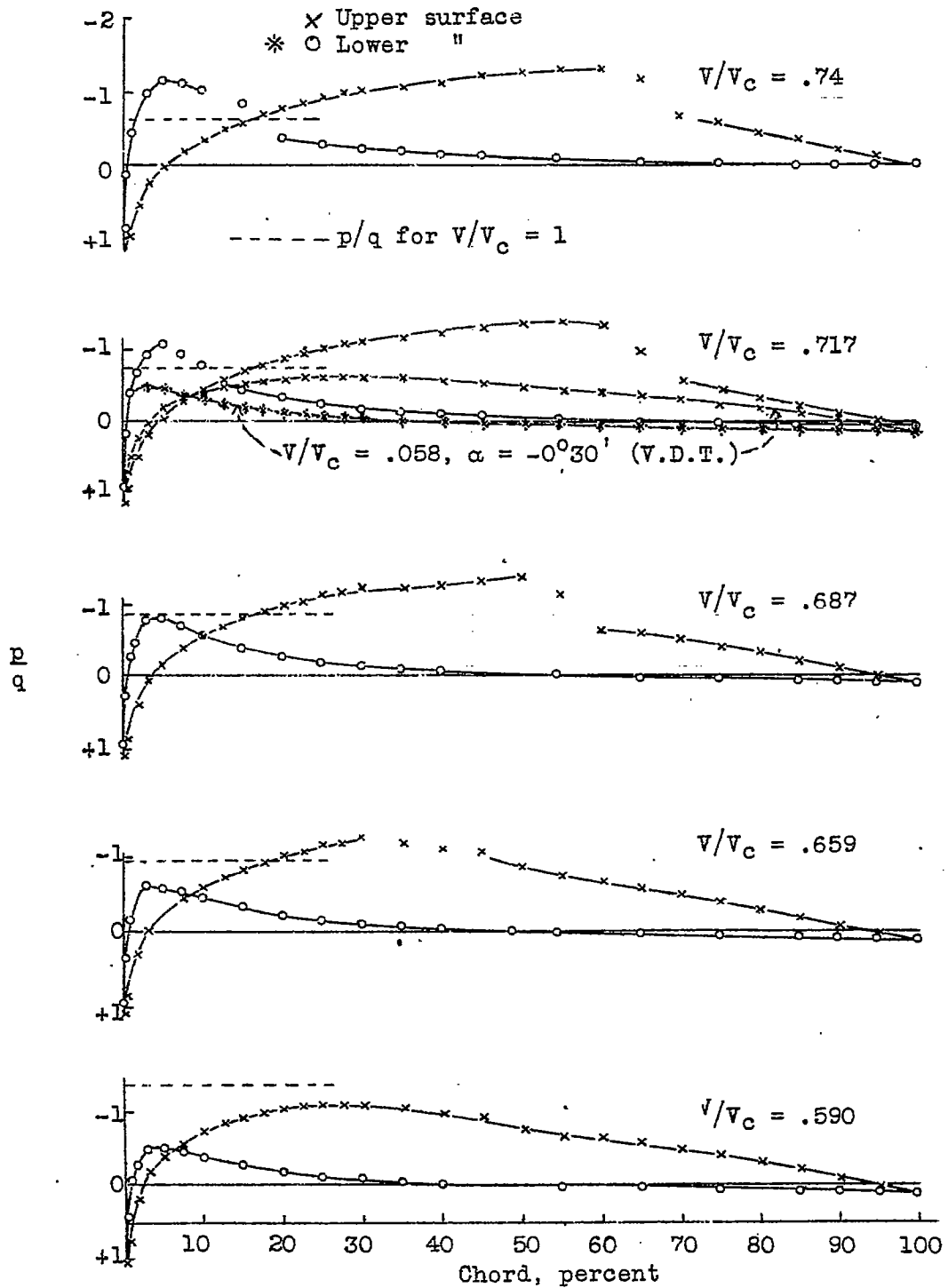

Figure 5.- Pressure distribution on the N.A.C.A. 4412 airfoil section, $\alpha = -0^\circ 15'$.

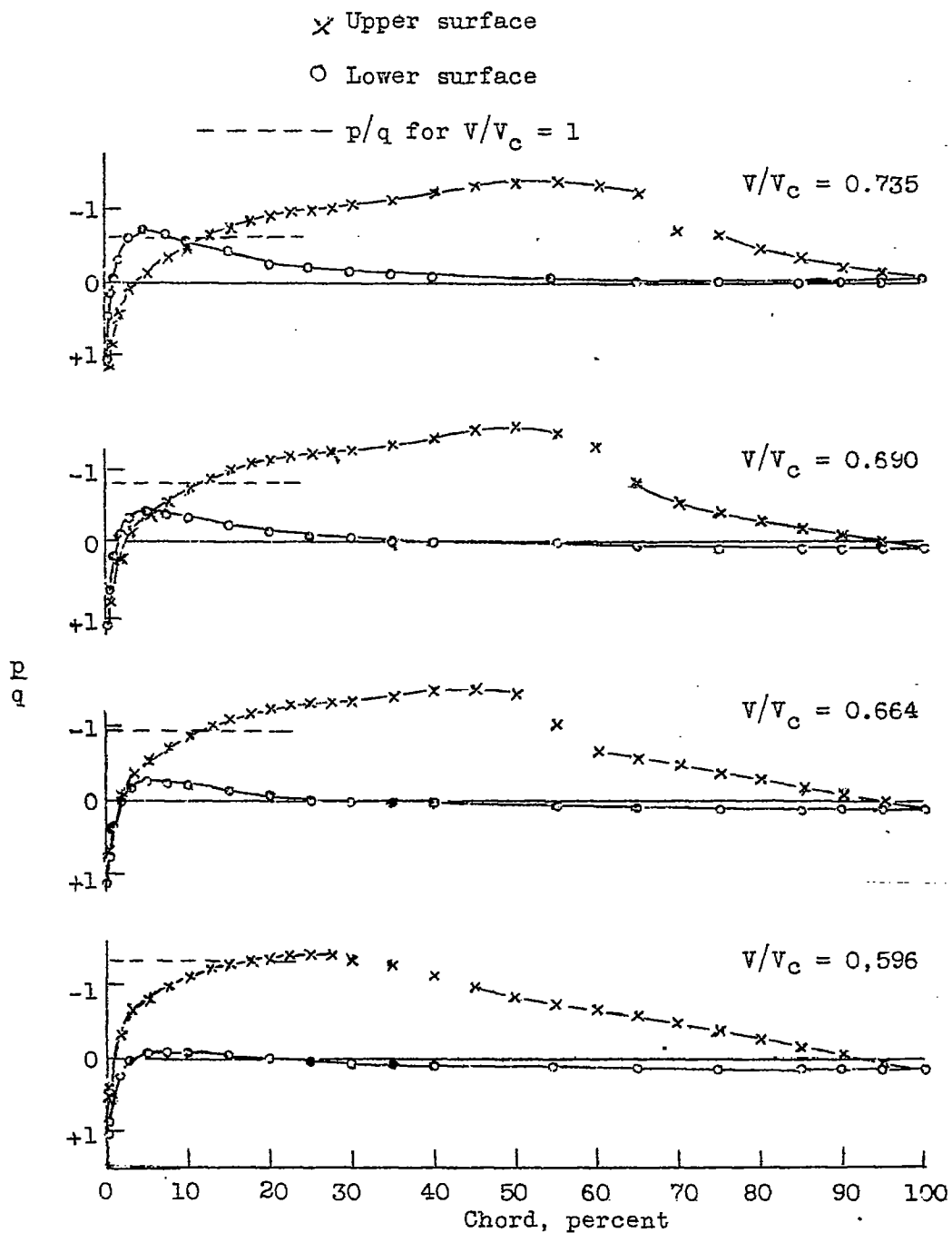

Figure 6.- Pressure distribution for N.A.C.A. 4412 airfoil.
 $\alpha = 1^\circ 52.5'$



Figure 7.- Schlieren flow photograph. N.A.C.A. 4412 airfoil; $\alpha = -2^\circ$; $V/V_c = 0.756$.

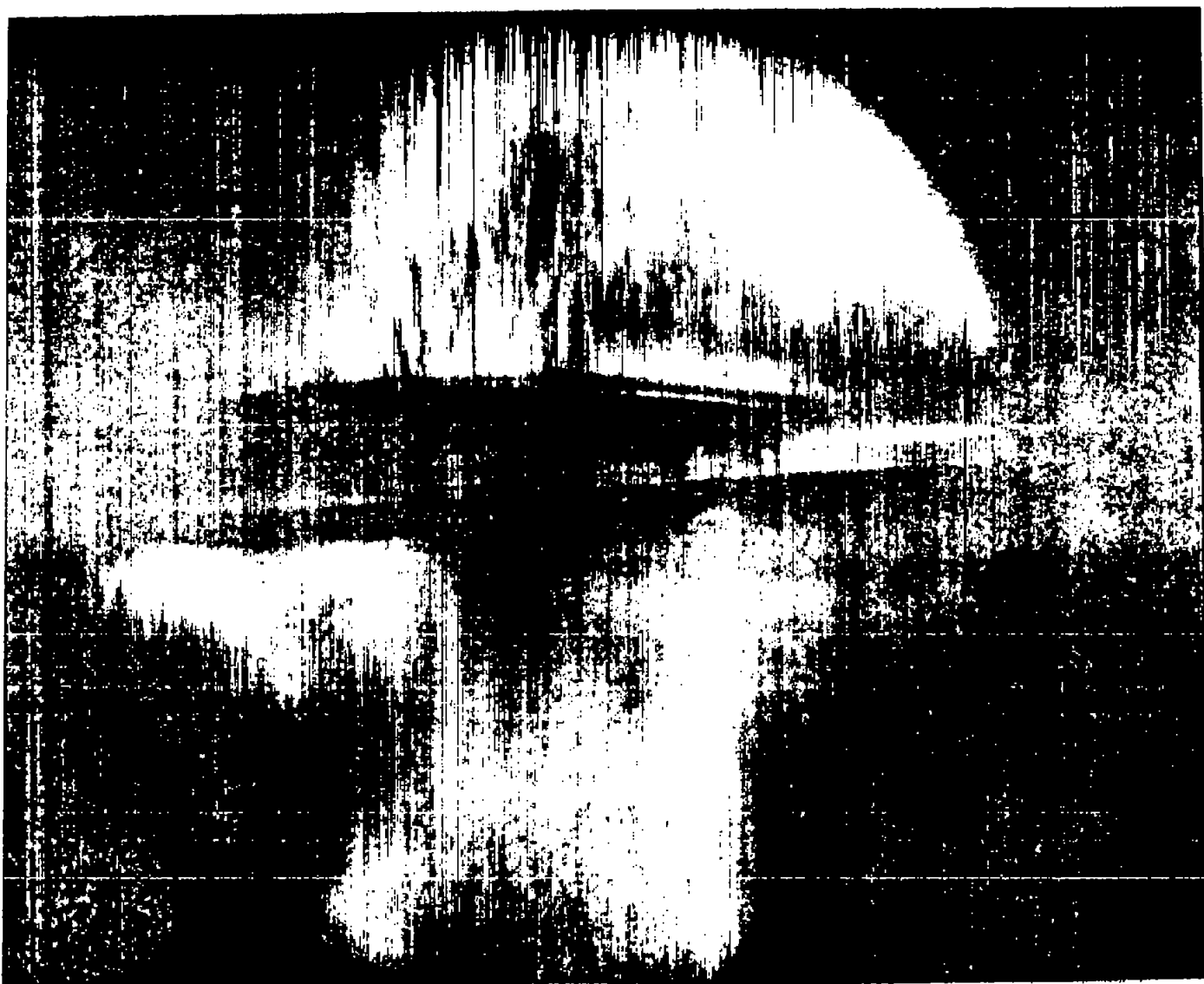

Figure 8.- Schlieren flow photograph. N.A.C.A. 4412 airfoil; $\alpha = -2^\circ$; $V/V_c = 0.668$.



Figure 9.- Schlieren flow photograph. N.A.C.A. 4412 airfoil; $\alpha = -15^\circ$; $V/V_c = 0.717$.



Figure 10.- Schlieren flow photograph. N.A.C.A. 4412 airfoil; $\alpha = 1^\circ$ $52\frac{1}{2}'$; $V/V_c = 0.690$