

Library. L. M. A. L.

TECHNICAL NOTES

NATIONAL ADVISORY COMMITTEE FOR AERONAUTICS

No. 461

THE EFFECT OF RIVET HEADS ON THE CHARACTERISTICS
OF A 6 BY 36 FOOT CLARK Y METAL AIRFOIL

By Clinton H. Dearborn
Langley Memorial Aeronautical Laboratory

Washington
May, 1933

NATIONAL ADVISORY COMMITTEE FOR AERONAUTICS

TECHNICAL NOTE NO. 461

THE EFFECT OF RIVET HEADS ON THE CHARACTERISTICS
OF A 6 BY 36 FOOT CLARK Y METAL AIRFOIL

By Clinton H. Dearborn

SUMMARY

An investigation was conducted in the N.A.C.A. full-scale wind tunnel to determine the effects of exposed rivet heads on the aerodynamic characteristics of a metal-covered 6 by 36 foot Clark Y airfoil. Lead punchings simulating 1/8-inch rivet heads were attached in full-span rows at a pitch of 1 inch at various chord positions. Tests were made at velocities varying from 40 to 120 miles per hour to investigate the scale effect.

Rivets at the 5 per cent chord position on the upper surface of the airfoil produced the greatest increase in drag for a single row. Nine rows of rivets on both surfaces, simulating rivet spacing of multispar construction, increased the drag coefficients by a constant amount at velocities between 100 and 120 miles per hour. Extrapolation of the curves indicates that the same increase would be obtained at speeds over 120 miles per hour. Accordingly, if rivets spaced the same as those on the test airfoil were used on a Clark Y wing of 300 square feet area and operated at 200 miles per hour the drag would be increased over that for the smooth wing by 55 pounds and the power required would be increased by 29 horsepower. The effect on the lift characteristics due to the rivets was found to be negligible.

INTRODUCTION

One of the most promising possibilities of improving the performance of airplanes lies in the reduction of drag. A recent airfoil investigation conducted in the N.A.C.A. variable-density wind tunnel on full-span protuberances (reference 1) and on short-span protuberances, including wing fittings (reference 2), showed that small protuberances have an important effect on the aerodynamic

characteristics of an airfoil. This investigation was extended to include the determination of the effects caused by exposed rivet heads of a type common to metal airplane wing construction. The latter tests were conducted in the full-scale wind tunnel on a 6 by 36 foot airfoil.

Lead punchings formed to simulate rivet heads were attached to the airfoil first in single rows at various chord positions on the upper surface, then in nine rows on the upper surface, and finally in nine rows on both surfaces.

APPARATUS AND METHODS

The 6 by 36 foot Clark Y airfoil used in this investigation is shown mounted in the tunnel in Figure 1. Two structural steel H beams with steel-angle connecting members form the primary structure of the airfoil; the ribs and skin are of 1/16-inch sheet aluminum. The outer surface of the skin was made as smooth as practicable by the use of butt joints and countersunk attaching screws. Rivet heads were simulated by gluing lead punchings to the surface of the airfoil as shown in Figure 2. These punchings were made from sheet lead with a die conforming in dimensions to the head of a 1/8-inch brazier head rivet. (Fig. 3.)

The airfoil was supported on the balance by two braced struts shown in Figure 1. All members were encased in fairings except the tops of the supports and the short struts for changing the angle of attack. The exposed members were made as small as practicable so that the tare drag would be a small percentage of the minimum drag of the airfoil. Tare-drag tests in which the airfoil was independently supported showed that the drag of the supports was only 4 per cent of the minimum drag of the plain airfoil at 100 miles per hour. A description of the balance will be given with the description of the tunnel now being prepared as a Technical Report.

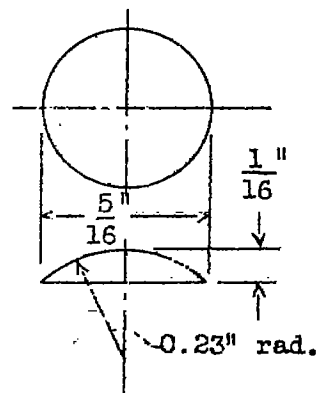

Figure 3.

TESTS

The effect on the drag of the airfoil of a single row of rivet heads at the leading edge, and at 5, 15, and 30 per cent of the chord back of the leading edge on the upper surface was first investigated. The single rows, as well as the combinations of rows at 10 per cent chord intervals tested later, extended over the full span of the airfoil with the rivets spaced 1 inch apart.

Starting with the 5 per cent chord position, nine rows were attached to the upper surface at increments of 10 per cent of the chord and the drag measured. Nine additional rows of rivet heads were later attached to the lower surface at the same chord positions as those on the upper surface and the drag again measured. The last condition of test is representative of the spacing of rivets on metal-covered wings of multispar construction. These tests were made at a dynamic pressure of 7.8 pounds per square foot, which corresponds to an indicated velocity of 55 miles per hour.

The plain airfoil and the airfoil with the nine rows of rivets on both the upper and lower surfaces were next tested at angles of attack in the region of minimum drag over a speed range from 40 to 120 miles per hour to investigate the magnitude of the scale effect. The effect of the rivets on lift was investigated by testing the airfoils from -8° to 21° angle of attack at a dynamic pressure of 16 pounds per square foot (79.2 miles per hour indicated velocity).

RESULTS AND DISCUSSION

Tunnel jet-boundary corrections have not been applied to the results presented in this report because the differences in lift were negligible and the differences in drag therefore would not be affected.

A comparison of the results obtained from the plain airfoil with those obtained with a single row of rivets at the various chord positions on the upper surface showed that the single row at the 5 per cent chord position produced the greatest increase in minimum drag. This increase in drag amounted to 19 per cent of the minimum drag of the plain airfoil. (Fig. 4.)

The nine rows of rivets on the upper surface of the airfoil at 10 per cent chord intervals extending from the 5 to 85 per cent chord positions caused a 21 per cent increase in minimum drag. This increase in drag is small compared with the increase of about 60 per cent that would be obtained from the summation of increases in minimum drag for single rows shown in Figure 4. The fact that the increases in drag due to the single rows failed to become additive for a combination of the same rows was probably due to a serious disturbing effect in the boundary layer caused by the first row of rivets.

The nine rows of rivets on both surfaces produced an increase of 27 per cent in drag. This is less than one-third more than the amount obtained with the rivets on the upper surface alone.

The preceding results were obtained from tests at 55 miles per hour. It will be noted in Figure 5 that the increase in minimum drag at 120 miles per hour for the airfoil with rivets on both surfaces is only 18 per cent of the minimum drag of the plain airfoil. This difference in increase of minimum drag may be attributed to scale effect; it may be assumed that the same scale effect would be present with the single row of rivets at the 5 per cent chord position and with the nine rows on the upper surface alone and that the percentage increase in minimum drag for these conditions would be proportionally reduced at the higher speeds.

Figure 5 shows a greater scale effect for the riveted airfoil than for the plain airfoil at the lower test velocities. However, at the higher velocities this difference in the scale effect disappears, resulting in a constant difference in minimum drag. Differences of the minimum drag coefficients and drag coefficients corresponding to the lift coefficients of 0.1, 0.2, and 0.3 for the two airfoils throughout the speed range are plotted in Figure 6. The increase in the drag coefficient due to the rivets is, for practical purposes, due solely to an increase in the profile drag, as indicated by the parallelism of the polars in Figure 8. The difference in drag coefficients at velocities between 100 and 120 miles per hour is 0.0018. It appears reasonable to assume that this difference in drag coefficients would remain the same at velocities even higher than those employed for this investigation.

The effect of the rivets on lift is practically negligible, as shown in Figure 7. The burble angle occurs 1° earlier with a decrease of about 1 per cent in the maximum lift coefficient.

The significance of the increase in profile drag may well be illustrated by estimating what effect it would have on the performance of an airplane. For this purpose an airplane with the following specifications was chosen and the assumption made that the wings were metal covered with exposed rivet heads on both surfaces in the same locations as those covered by the tests.

Wing area	300 sq.ft.
Wing section	Clark Y
Engine	500 b.hp
Fuel consumption	0.5 lb./b.hp-hr.
Propulsive efficiency	80 per cent
High speed	200 m.p.h.
Cruising speed	170 m.p.h.

These specifications are representative of a modern high-speed transport or a military observation airplane.

The extrapolated drag curve in Figure 6 shows that the increase in drag caused by the rivets would be 40 pounds at the cruising speed of 170 miles per hour and 55 pounds at the high speed of 200 miles per hour. These drag forces, taking the propulsive efficiency into account, would consume 23 and 37 brake horsepower, respectively, at the cruising and high speeds. The increase in fuel consumption due to the rivets at the cruising speed, based on a weight of 6 pounds per gallon, would be 1.9 gallons per hour. This amount represents about 7 per cent of the fuel consumption at the cruising speed. The high speed would be increased from 200 to 205 miles per hour by the elimination of the exposed rivet heads.

CONCLUSIONS

1. A single row of rivets located at the 5 per cent chord position on the upper surface of the airfoil produced a greater increase in the minimum drag than any other position investigated.
2. Rivets added on the upper surface of the airfoil

back of a single row at the 5 per cent chord position had little effect on drag.

3. Nine rows of rivets on the lower surface increased the drag less than one-third of the amount that the same number of rows did on the upper surface.

4. The effect of rivets on maximum lift was negligible.

5. Exposed rivet heads of the type and spacing investigated would have an appreciable detrimental effect on the fuel consumption and high speed of an airplane.

Langley Memorial Aeronautical Laboratory,
National Advisory Committee for Aeronautics,
Langley Field, Va., February 4, 1933.

REFERENCES

1. Jacobs, Eastman N.: Airfoil Section Characteristics as Affected by Protuberances. T.R. No. 446, N.A.C.A., 1932.
2. Jacobs, Eastman N., and Sherman, Albert: Wing Characteristics as Affected by Protuberances of Short Span. T.R. No. 449, N.A.C.A., 1932.

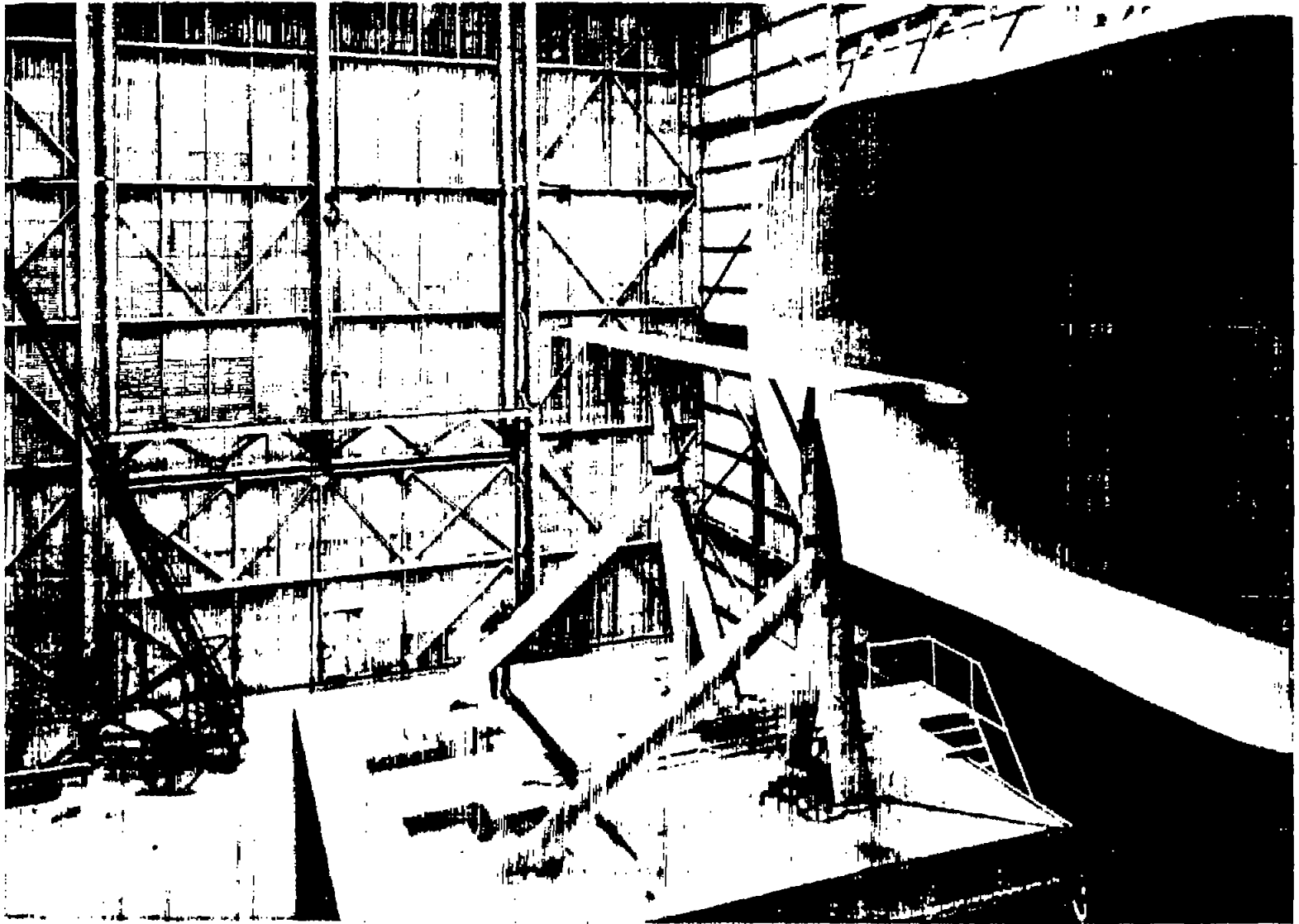

Figure 1.--The 6 by 36 foot Clark Y airfoil mounted on balance.

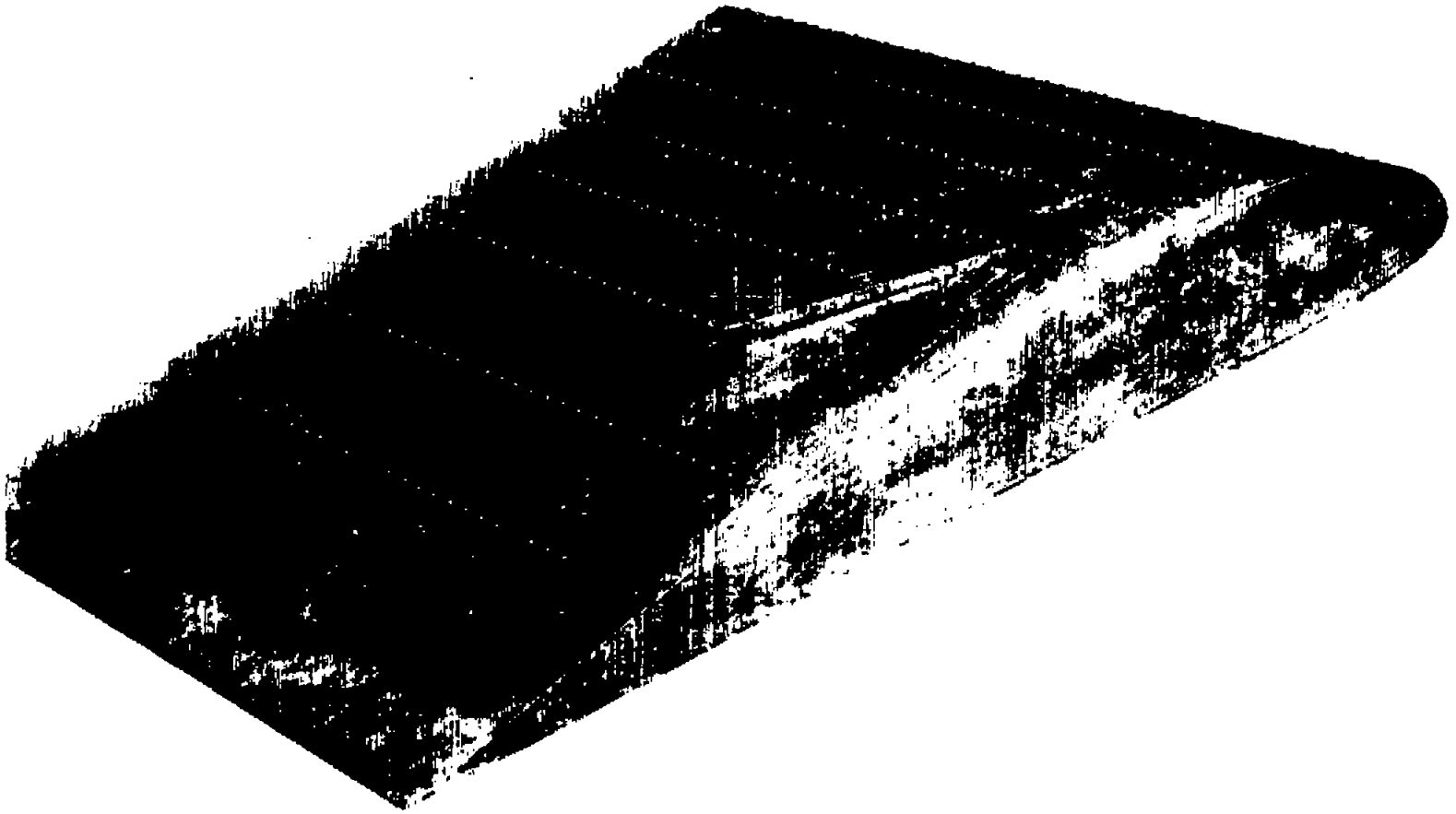

Figure 2.-Nine rows of rivet heads on upper surface of airfoil.

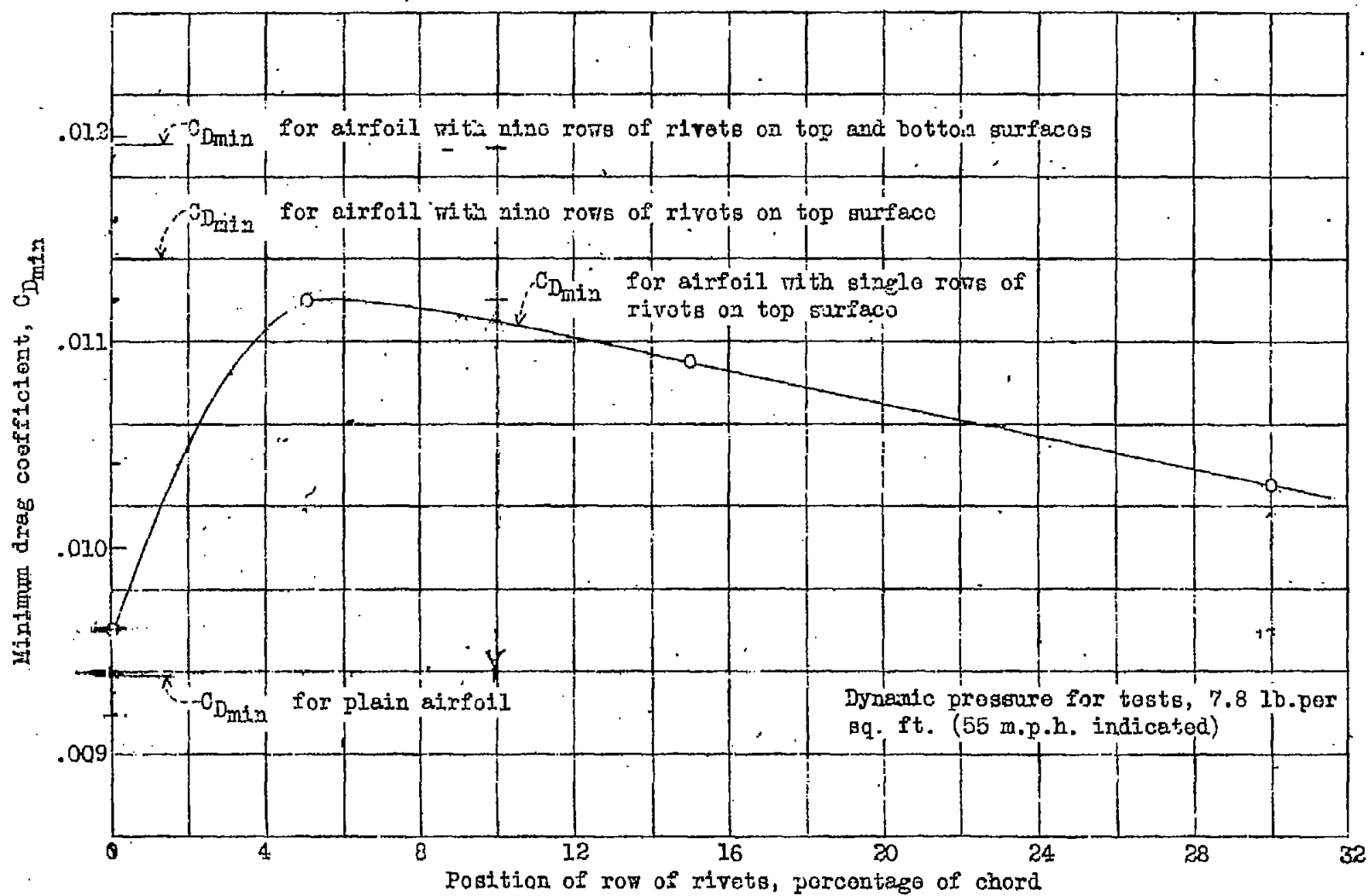

Figure 4.—Minimum drag coefficient for airfoil with rivet arrangements tested.

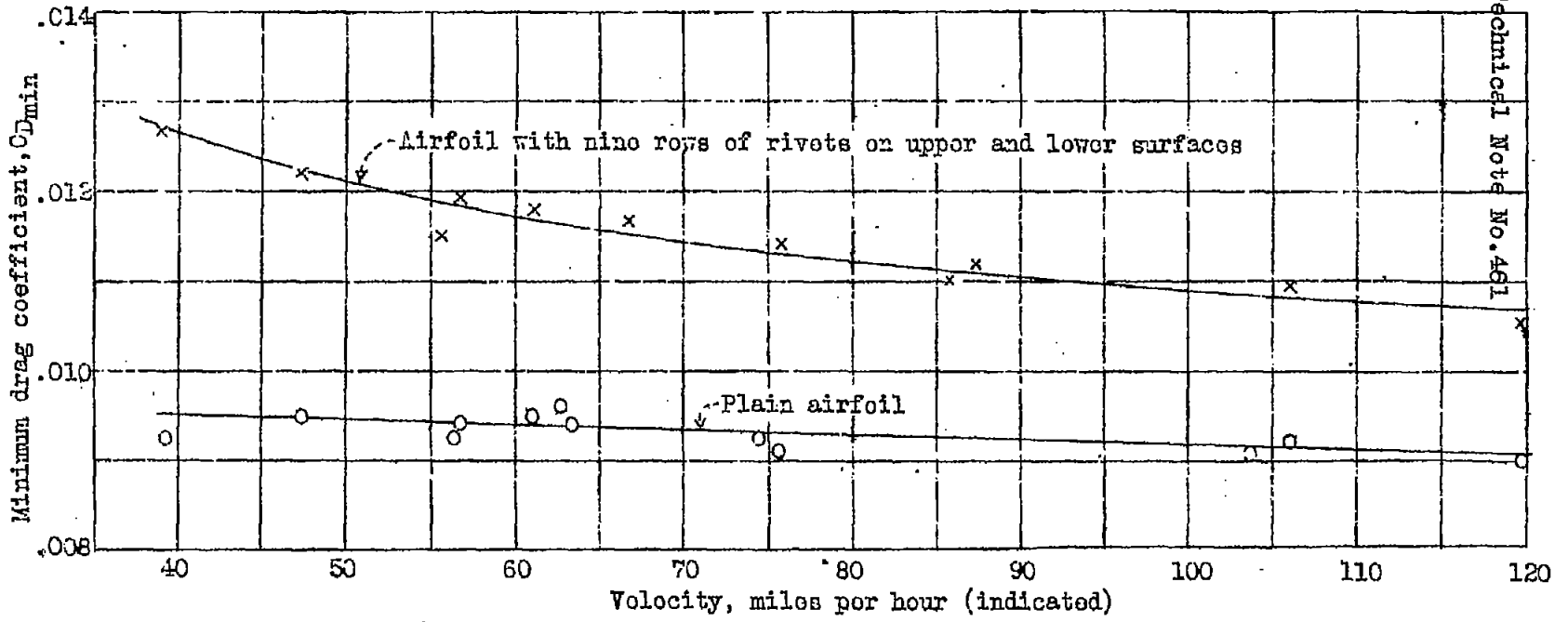

Figure 5.-Scale effect on C_{Dmin} for the plain airfoil and airfoil with 18 rows of rivets.

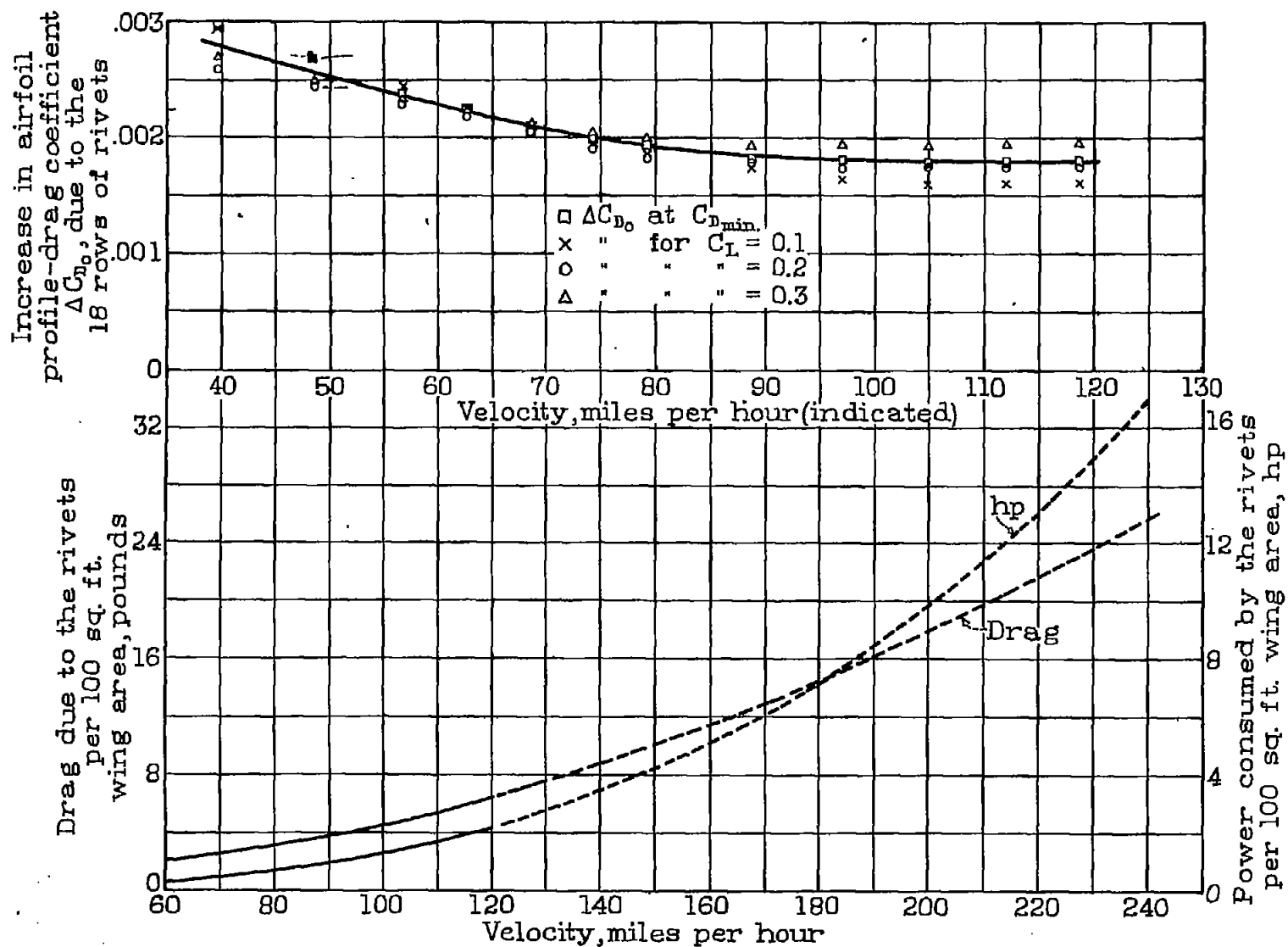

Figure 6.- Increase in profile-drag coefficient, drag, and power required due to the rivets.

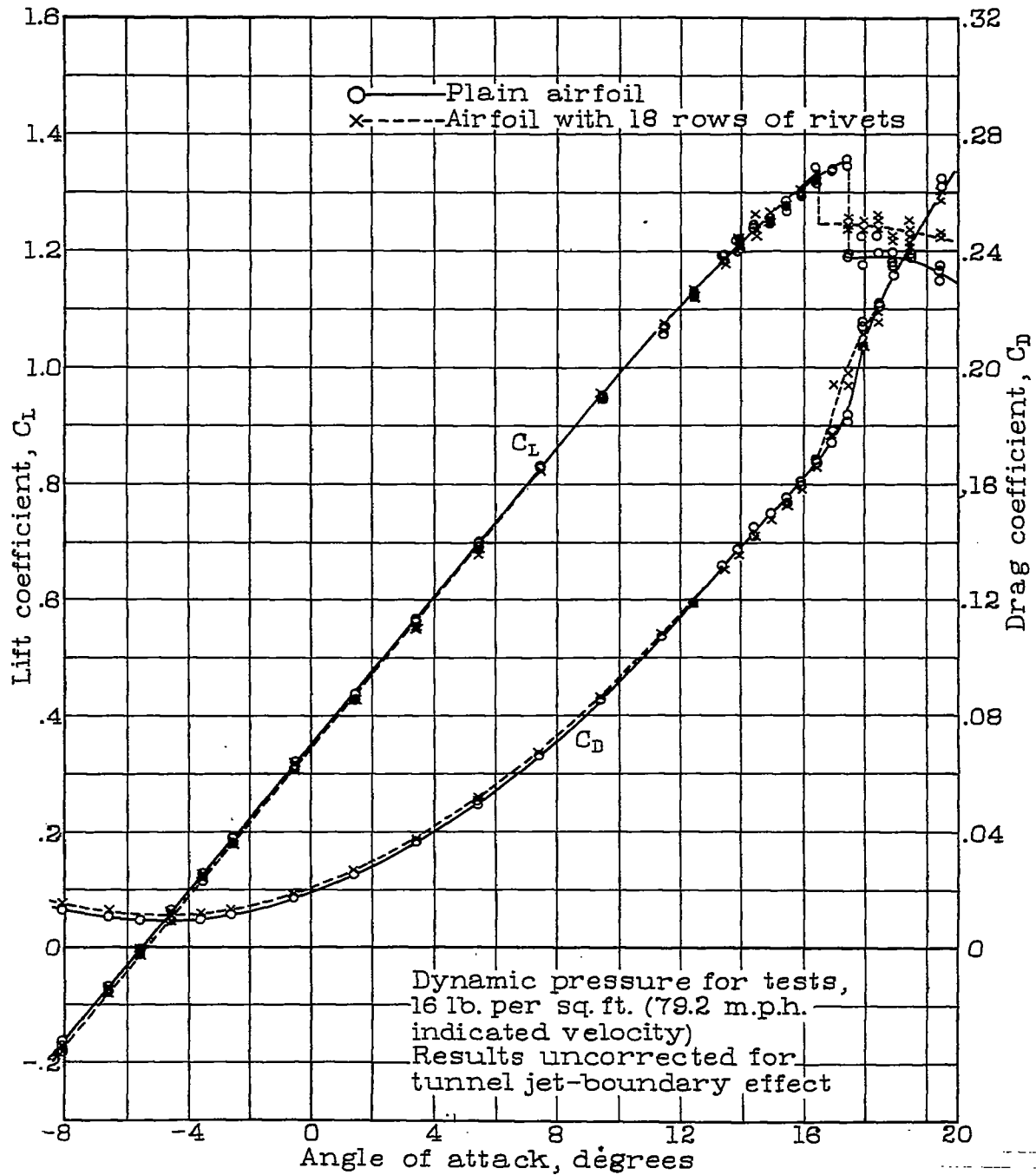

Figure 7.-Variation of lift and drag with angle of attack for plain airfoil and airfoil with rivets.

Fig. 8

N.A.C.A. Technical Note No. 461

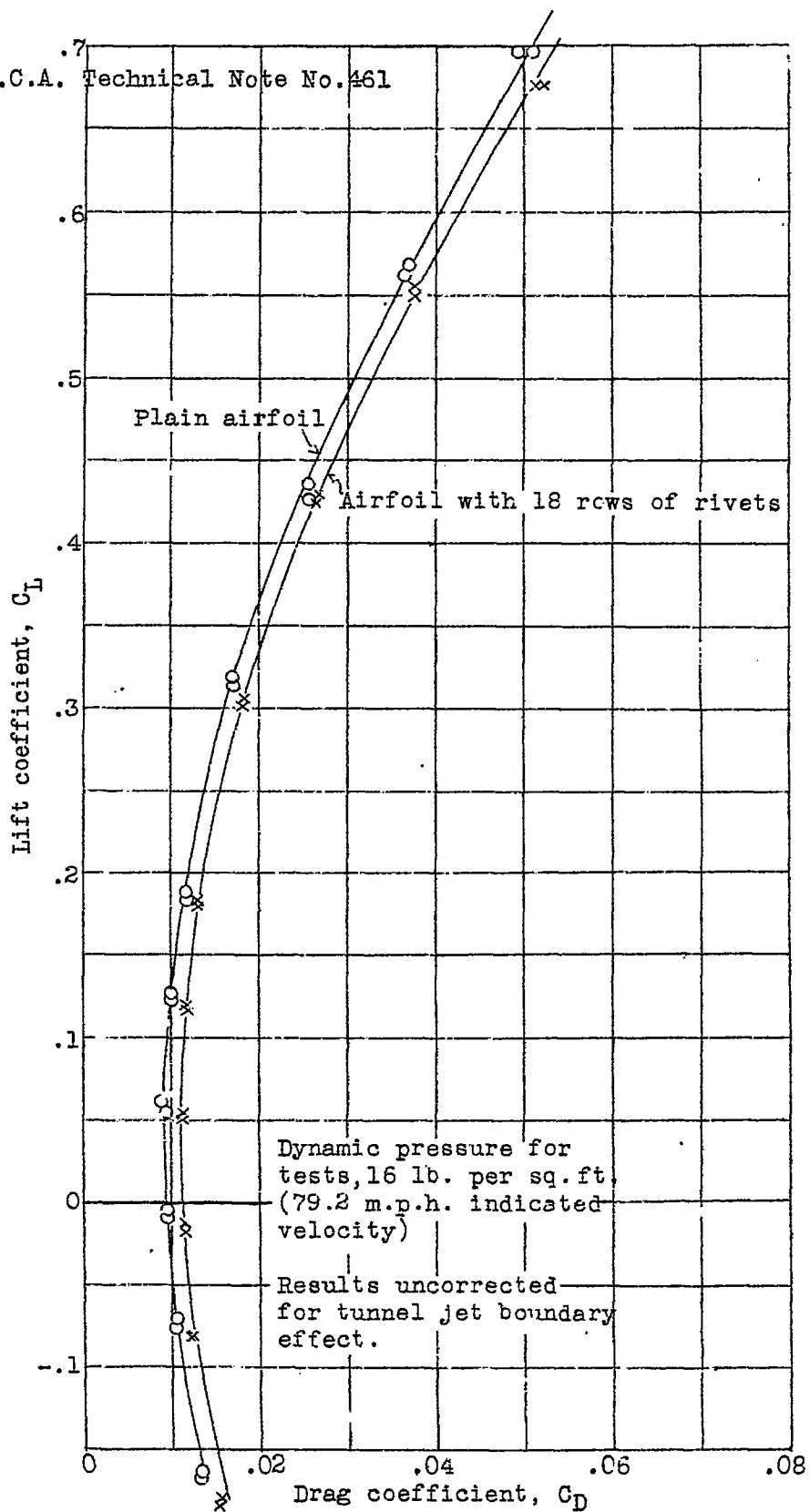

Figure 8.-
Polars
for
plain
airfoil
and
airfoil
with
rivets.