REPORT No. 304

**AN INVESTIGATION
OF THE AERODYNAMIC CHARACTERISTICS OF
AN AIRPLANE EQUIPPED WITH SEVERAL
DIFFERENT SETS OF WINGS**

By J. W. CROWLEY, Jr., and M. W. GREEN
Langley Memorial Aeronautical Laboratory

REPORT No. 304

AN INVESTIGATION OF THE AERODYNAMIC CHARACTERISTICS OF AN AIRPLANE EQUIPPED WITH SEVERAL DIFFERENT SETS OF WINGS

By J. W. CROWLEY, Jr., and M. W. GREEN

SUMMARY

This investigation was conducted by the National Advisory Committee for Aeronautics at Langley Field, Va., at the request of the Army Air Corps, for the purpose of comparing the full scale lift and drag characteristics of an airplane equipped with several sets of wings of commonly used airfoil sections. A Sperry Messenger airplane with wings of R. A. F.-15, U. S. A.-5, U. S. A.-27, and Göttingen 387 airfoil sections was flown and the lift and drag characteristics of the airplane with each set of wings were determined by means of glide tests.

The results are presented in tabular and curve form.

INTRODUCTION

While there is a very considerable amount of data existent on the aerodynamic characteristics of airplanes and airfoils as obtained in wind tunnel model tests, very little information of this kind has been obtained in full-scale flight test. For the purpose of comparing directly the full-scale lift and drag characteristics of a number of commonly used airfoils and also of providing a basis for comparison with model tests, the present tests on a Sperry Messenger airplane equipped with R. A. F.-15, U. S. A.-5, U. S. A.-27, and Göttingen 387 wings were instituted. The investigation was conducted by the National Advisory Committee for Aeronautics, at Langley Field, Va., at the request of the Army Air Corps. The airplane and wings were furnished by the latter. Six sets of wings of different airfoil section were constructed for the investigation, but during the conduction of the tests this type of airplane was condemned as being structurally unsafe and only the above-mentioned wings were used.

The lift and drag characteristics of the complete airplane with each set of wings were obtained by means of glide tests with the propeller operating at the $\frac{V}{nD}$ of zero thrust. It is essential in glide tests that the airplane be motivated by its weight only and, consequently, propeller thrust must be eliminated or allowed for. Two general methods are used: (1) Glide tests with the propeller stopped and locked in a definite position, and (2) glide tests with the propeller operating at the $\frac{V}{nD}$ to produce no thrust. It was necessary to use the latter method in this investigation since the size and loading of the airplane prohibited the use of propeller braking apparatus on the engine.

The $\frac{V}{nD}$ to be used in flight was determined from the results of a wind tunnel test of a 3-foot model of the Sperry Messenger propeller, tested with no body behind it. It was realized that the value thus obtained would be different from the actual $\frac{V}{nD}$ of zero thrust in flight since scale effect and the presence of a body behind the propeller would be expected to change this value, and consequently the propeller operating at this $\frac{V}{nD}$ in flight would be delivering

some thrust. However, since it was a part of the program of these tests to measure the actual $\frac{V}{nD}$ of zero thrust on the identical airplane and propeller at a later date in the 20-foot propeller research tunnel (then under construction), it was considered satisfactory to conduct the flight tests at the $\frac{V}{nD}$ determined from the model test, as approximating the true $\frac{V}{nD}$ of zero thrust, and then correct the flight results for thrust on the basis of the measurements obtained in the propeller research tunnel tests, when the latter were made available. Actually the flight tests were made at a $\frac{V}{nD}$ of 1.08 while the true $\frac{V}{nD}$ for zero thrust as determined in the propeller research tunnel was 1.07 to 1.08, making the correction on this account negligible.

APPARATUS AND METHOD

AIRPLANE AND WINGS.—A standard Sperry Messenger airplane (fig. 1) equipped with United States Air Service propeller No. 048765 and with four interchangeable sets of wings of different airfoil section was used in this investigation. The airfoil sections were R. A. F.-15, U. S. A.-5, U. S. A.-27, and Göttingen 387. The wings were all of rectangular plan form with equal area and aspect ratio (fig. 2) and were constructed in the conventional manner for wooden

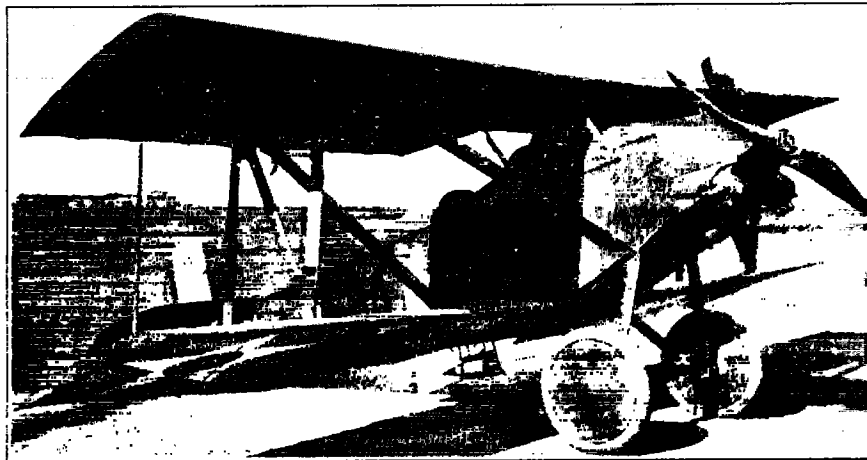

FIG. 1.—Sperry Messenger airplane with flight path angle recorder installed

wings with plywood between the leading edge and the front spar. The dimensions of the biplane cellule were the same for all sets of wings: Span 20 feet, gap 3 feet 10 inches, dihedral $1\frac{1}{2}^\circ$, and incidence $+2^\circ$. The stabilizer was fixed at $+1\frac{1}{2}^\circ$ throughout the tests. Including the area of the center section the total wing area was 148.5 square feet.

INSTRUMENTS.—The following special test instruments were used:

(1) *N. A. C. A. flight path angle and air-speed recorder* (reference 1).—This instrument, as its name implies, was used for measuring the air speed and the angle of inclination that the airplane's flight path made with the horizontal. It is a suspended type instrument and in these tests was lowered approximately 35 feet below the airplane.

(2) *N. A. C. A. recording inclinometer*.—This instrument consists essentially of an oil-damped pendulum mounted in the standard photographic recording type of instrument used by the N. A. C. A. It was used to record the attitude of the airplane with respect to the horizontal which, together with the flight path angle, determines the angle of attack.

(3) *N. A. C. A. recording altimeter and air-speed meter*.—This instrument is a standard recording air-speed meter (reference 2) with an aneroid mechanism incorporated in it. It was used primarily to measure the barometric pressure during the tests. The air-speed readings provided a check on the air speed recorded by the flight path recorder and the change of altitude with time, together with the air speed, was used to check the flight path angle recorded by the flight path recorder.

(4) *N. A. C. A. control position recorder* (reference 3).—This instrument was used to measure the elevator angle during the tests.

(5) *Revolution counter*.—The revolutions of the engine were recorded by means of a contact-making apparatus which, connected to the service tachometer shaft, completed an electrical circuit every 50 revolutions of the engine and flashed a light in a standard photographic type recording instrument. These light flashes were recorded on a moving film as a series of dots and knowing the film speed enabled the computation of engine revolutions per minute. Film speed was determined from timing lines placed on the record as mentioned below.

(6) *Thermometer*.—An indicating distance thermometer, mounted on the strut, the readings of which were taken by the pilot, gave the air temperatures during the tests.

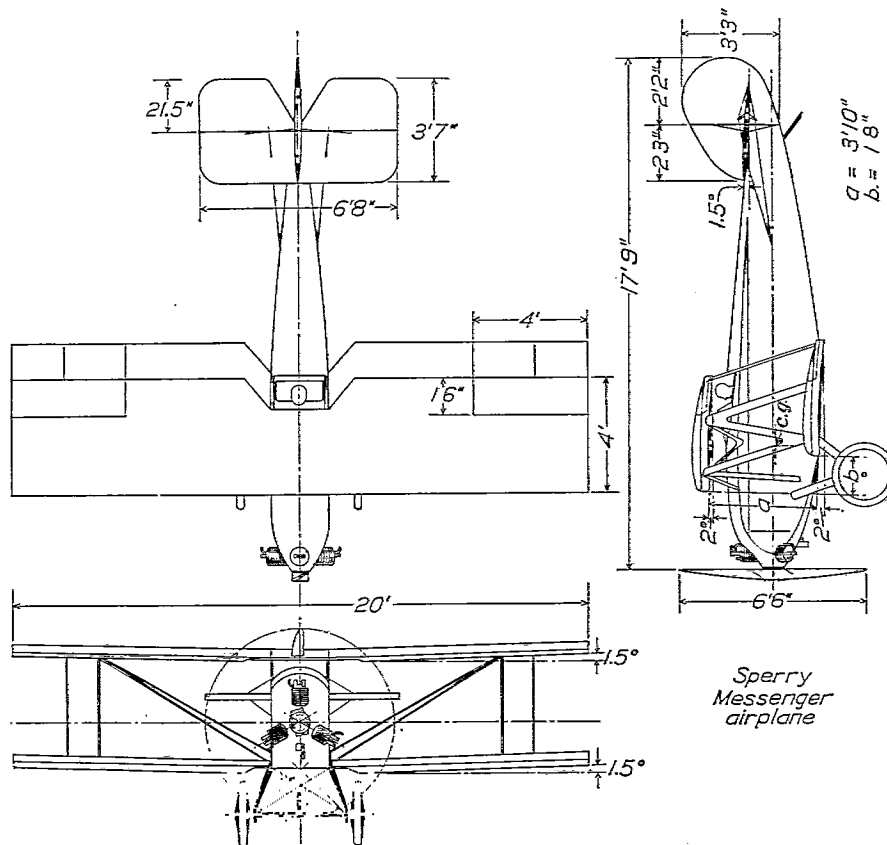

FIG. 2.—Elevations and plan of the Sperry Messenger airplane

The photographic records of all of the above instruments were synchronized by means of timing lines placed simultaneously on all the records at definite time intervals by an N. A. C. A. timer. (Reference 4.)

FLIGHT TESTS.—Preliminary tests were made in level flight to determine the airworthiness of each set of wings and the desirability of continuing further tests.

Following the preliminary tests, the lift and drag characteristics of the airplane when equipped with each set of wings were obtained by means of glide tests (reference 5) with the propeller operating at the $\frac{V}{nD}$ of zero thrust. As previously mentioned, this value of $\frac{V}{nD}$ determined from the results of a 3-foot model test was 1.08. Glides were made at predetermined air speeds and engine revolutions per minute for a change of altitude of approximately 1,000 feet and records were taken for about one-half minute after the airplane had reached a steady condition. The range of speed covered was approximately 45 to 105 miles per hour. On each glide the following data were obtained: airplane weight, angle of flight path to horizontal, angle of wing chord to horizontal, dynamic pressure, barometric pressure, temperature, propeller revolutions

per minute, and elevator angle. All of these were obtained from the instruments previously mentioned except the weight, which was measured before each flight. An allowance was made for the weight of fuel burned during flight.

REDUCTION OF DATA.—The essential observed and computed data for the determination of lift and drag characteristics are given in Tables I, II, III, and IV.

While it was attempted to conduct the glide tests with the propeller operating at the $\frac{V}{nD}$ of no thrust, this was seldom exactly accomplished since in the first place, as mentioned before, the $\frac{V}{nD}$ of the model test was not the true $\frac{V}{nD}$ for zero thrust in flight, and secondly (and most important) because of the difficulties in adjusting the airplane's air speed and engine speed to obtain the exact $\frac{V}{nD}$ desired. Consequently, there was nearly always a small amount of thrust acting in addition to the weight of the airplane to produce the motion of the airplane, that had to be corrected for as follows:

The apparent drag is equal and opposite to $W \sin \gamma$, where γ is the angle of the flight path. Since thrust is present, true drag is equal to apparent drag plus the drag component of thrust or $D = W \sin \gamma + T \cos \beta$, where β is the angle of the thrust axis with the flight path. Since β is small it is possible, within the limits of accuracy of the measurements, to consider $T \cos \beta = T$ and the true drag is therefore equal to $W \sin \gamma + T$. T is determined for the $\frac{V}{nD}$ attained in flight from the thrust coefficient curve for this same propeller and airplane obtained in tests in the propeller research tunnel. (Fig 3)

In a like manner lift is equal to $W \cos \gamma + T \sin \beta$. Since $T \sin \beta$ is negligible, lift is equal to $W \cos \gamma$.

The angle of attack given in the tables and curves is the angle of attack of the wing, and the coefficients are given in the absolute form, where

$$C_L = \frac{L}{qS}$$

$$C_D = \frac{D}{qS}$$

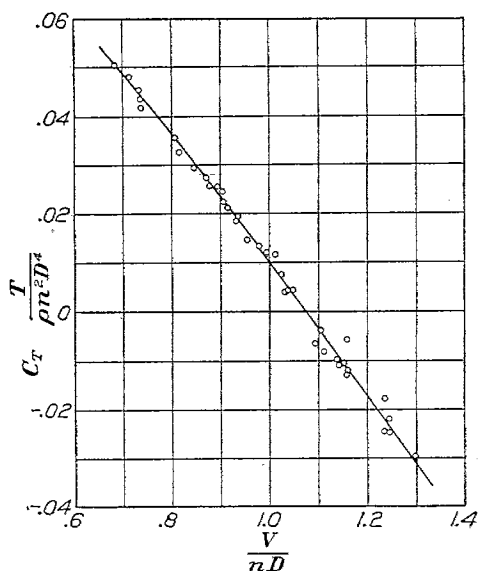

Fig. 3.—Propeller thrust characteristics from propeller research tunnel tests

PRECISION.—The greatest sources of error encountered in flight tests of this type are due to accelerations imposed on the airplane and the flight path recorder by uneven air conditions or the piloting of the airplane during a glide. The instruments used were calibrated frequently during the tests and the errors due to inherent instrumental errors are believed to be negligible in comparison with the others. The tests were made only when the air was found to be unusually smooth and any readings that indicated the presence of accelerations were discarded, but even under these conditions and with the most careful piloting it is probable that accelerations were present to some extent. In general, considering the number and grouping of the experimental points, it is believed that the faired curves of lift and drag coefficients are precise to within ± 2 per cent. In the determination of angle of attack, accelerations might cause greater errors since this measurement is obtained from the readings of two pendulum type instruments and the angle of attack may, therefore, be in error as much as ± 3 or ± 4 per cent.

Another possible source of error lies in the fact that, while the propeller characteristics were determined in the wind tunnel with the propeller axis parallel to the relative wind, in flight the propeller was always operating with its axis at some angle of pitch, and consequently the $\frac{V}{nD}$ for zero thrust from the wind tunnel tests might not be exactly that obtained in flight. However,

subsequent tests in the propeller research tunnel on a propeller operating with its axis at a pitch of 5° , indicated that the pitch produced no measurable change in the propeller characteristics, and it has been assumed in these tests that errors due to this cause are negligible.

RESULTS

The results of the investigation are given in Tables I to IV, and Figures 4 to 15. Figures 4, 5, 6, and 7 give the polar diagrams of the airplane when equipped with R. A. F.-15, U. S. A.-5, U. S. A.-27, and Göttingen 387 wings, respectively, with the experimental points shown thereon. The polars for all four sets of wings are plotted together for comparison in Figure 8. In addition, the C_L , C_D , and L/D versus angle of attack for these wings have been plotted in Figures 9 to 15, where Figures 9, 10, 11, and 12 give these results for each set of wings with the experimental points shown, and Figures 13, 14, and 15 compare the C_L , C_D , and L/D , respectively.

It will be noted that considerably fewer measurements were obtained with the Göttingen 387 wings than with any of the others and consequently the curves for these are not as definitely established. This was occasioned by the fact that the airplane was condemned while the tests with these wings were in progress.

The results, as shown on the curves, cover the usual flying range of an airplane without reaching maximum lift or minimum drag, although the latter is more closely approached. It is usually difficult to obtain maximum lift in glide tests, and it was almost impossible in these particular tests since the engine could not be throttled sufficiently to give the proper $\frac{V}{nD}$ at the low air speed required without danger of stopping the propeller. This would have been extremely hazardous because the pilot had to reel in the suspended flight path recorder in addition to piloting the airplane. Even without this difficulty it is believed that only slightly higher lifts could have been reached as the lateral control of the airplane was poor and the difficulties in holding the airplane in a steady glide at low speed were great.

The comparison of the lift and drag characteristics is best shown in Figure 8. This figure indicates that, as would be expected, the use of the thin section, R. A. F.-15, gives the lowest maximum lift and minimum drag, while the thicker section, Göttingen 387, gives the greatest maximum lift and highest minimum drag. The U. S. A.-5 and U. S. A.-27 give quite similar effects in all respects.

The comparisons given in Figures 13 and 14 are mainly of interest in that they show that the slopes of the lift curves (and to a somewhat less extent the slopes of the drag curves) are not greatly different, indicating quite similar characteristics with all sets of wings except, of course, in the region of maximum lift.

The comparison of the L/D of the airplane with the different wings (fig. 15) shows that the use of the U. S. A.-5 wings gave the highest L/D and the U. S. A.-27 only a slightly lower value.

In general, the results, particularly as shown in Figure 8, emphasize one fact which it is believed is not sufficiently appreciated and that is, that with the exception of the change in maximum lift, the use of different reasonably good airfoil sections in themselves can not be expected to greatly change the performance of an airplane. When it is considered that the drag of an airplane consists of the airplane's parasite drag, the profile and induced drag of the tail surfaces, the induced drag of the wings, and the profile drag of the wings, it will be more appreciated that different airfoil sections, which change only the wing profile drag, can not be expected to produce any great changes in the airplane's performance.

BIBLIOGRAPHY

- Reference 1. Coleman, D. G.: N. A. C. A. Flight Path Angle and Air-Speed Recorder. N. A. C. A. Technical Note No. 233 (1926).
- Reference 2. Norton, F. H.: N. A. C. A. Recording Air-Speed Meter. N. A. C. A. Technical Note No. 64 (1921).
- Reference 3. Ronan, K. M.: An Instrument for Recording the Position of Airplane Control Surfaces. N. A. C. A. Technical Note No. 154 (1923).
- Reference 4. Brown, W. G.: The Synchronization of N. A. C. A. Flight Records. N. A. C. A. Technical Note No. 117 (1922).
- Reference 5. Green, M. W.: Determination of the Lift and Drag Characteristics of an Airplane in Flight. N. A. C. A. Technical Note No. 223 (1925).

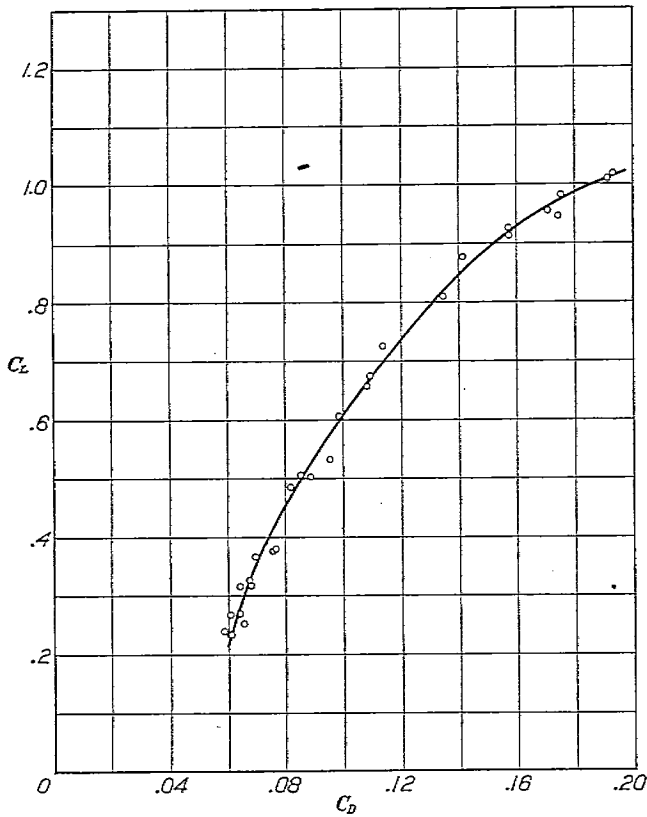

FIG. 4.—Sperry Messenger tests. Characteristics of R. A. F.-15 wings. Glide at $\frac{V}{nD} = 1.075$

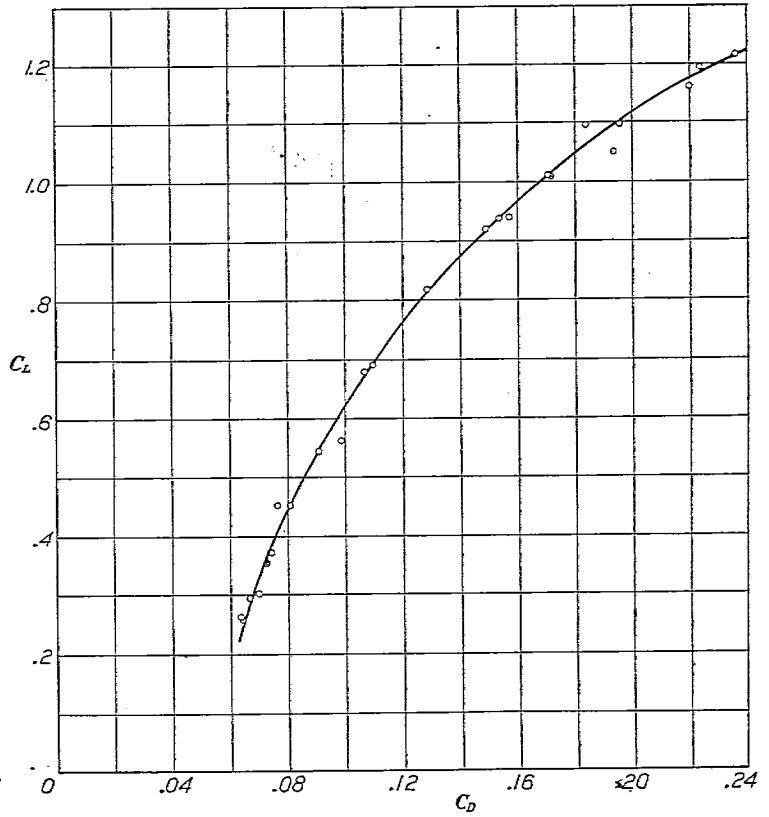

FIG. 6.—Sperry Messenger tests. Characteristics of U. S. A.-27 wings. Glide at $\frac{V}{nD} = 1.075$

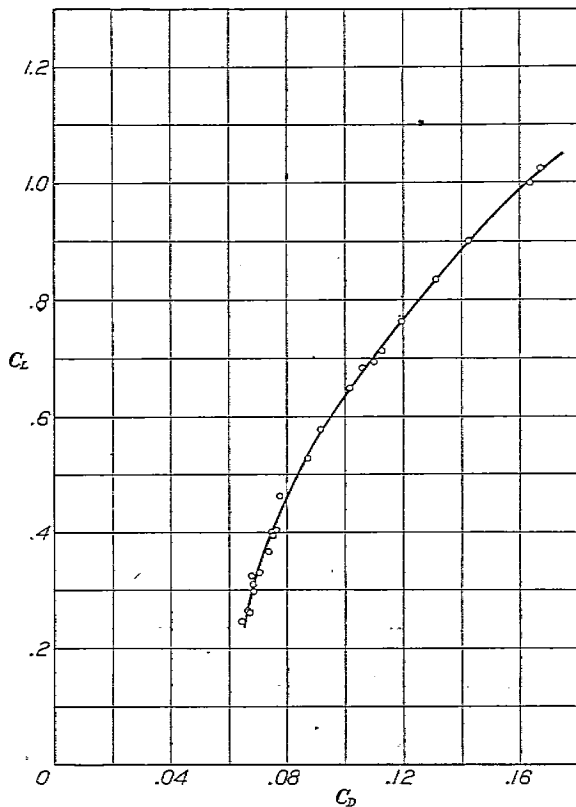

FIG. 5.—Sperry Messenger tests. Characteristics of U. S. A.-5 wings. Glide at $\frac{V}{nD} = 1.075$

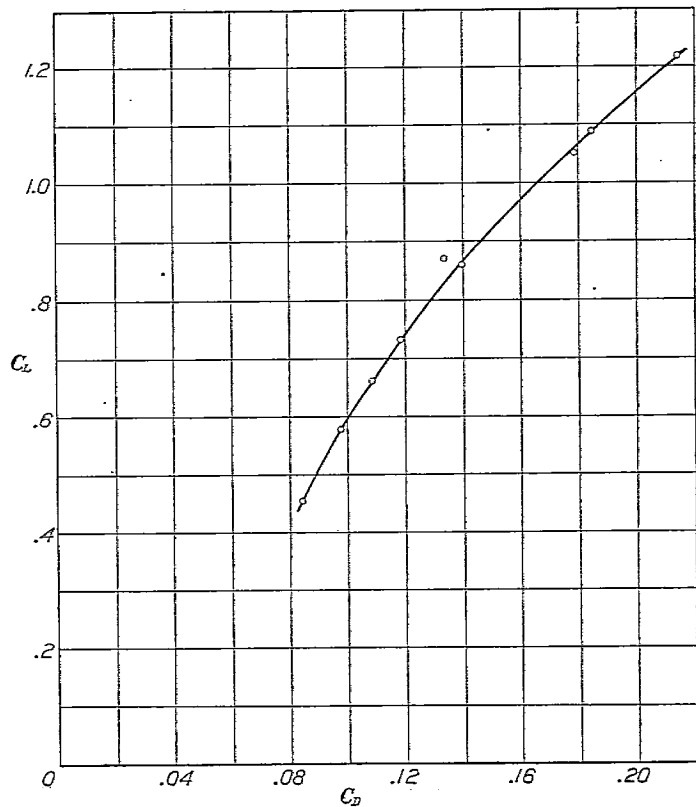

FIG. 7.—Sperry Messenger tests. Characteristics of Göttingen 337 wings. Glide at $\frac{V}{nD} = 1.075$. (Limited data)

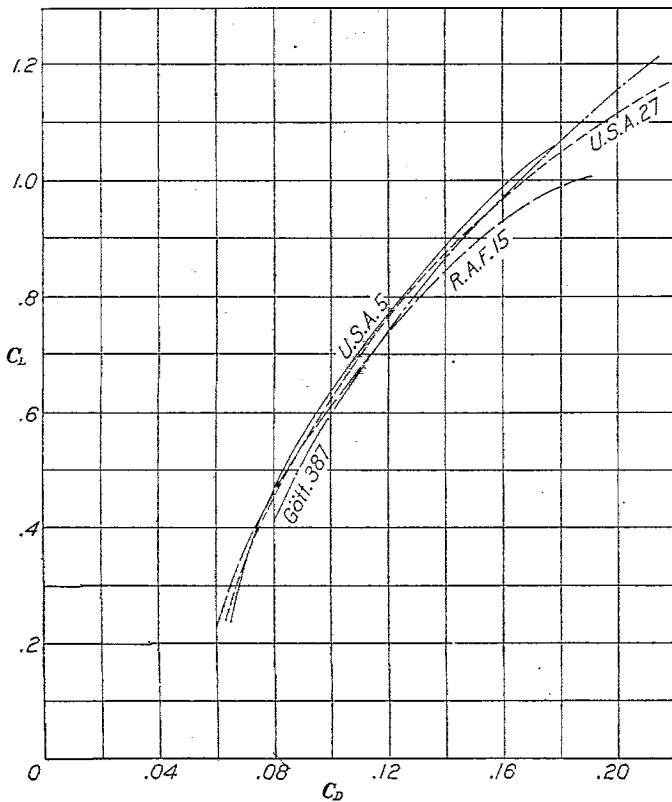

FIG. 8.—Sperry Messenger tests. Characteristics of the various wings. Glide at $\frac{V}{nD} = 1.075$

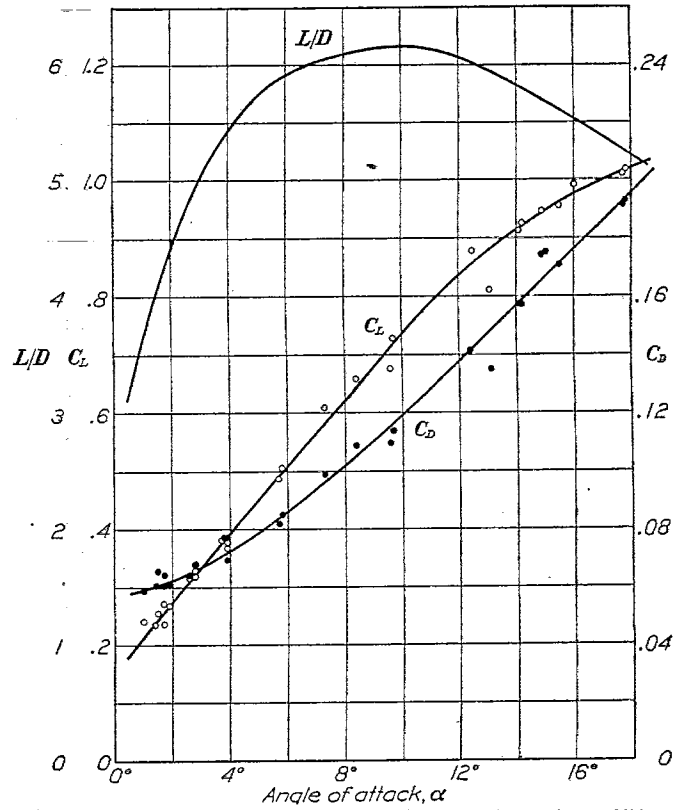

FIG. 9.—Sperry Messenger tests. Characteristics of R. A. F.-15 wings. Glide at $\frac{V}{nD} = 1.075$

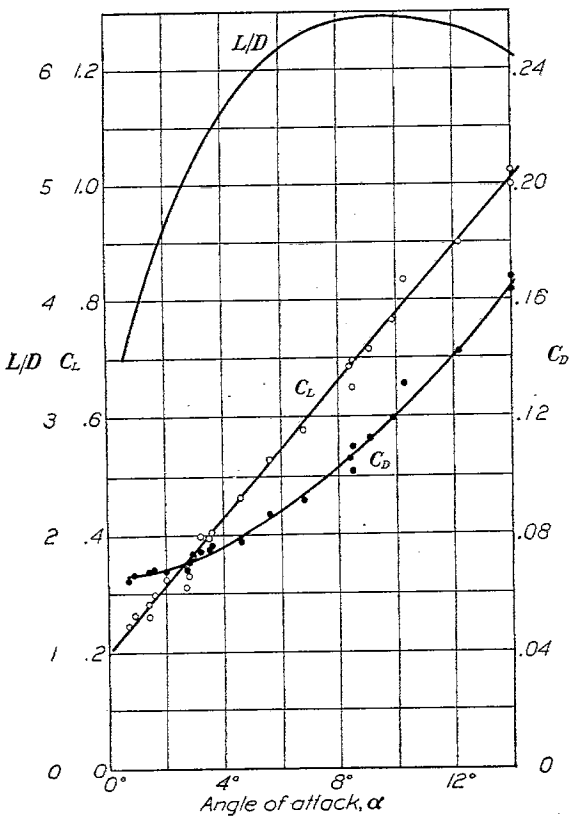

FIG. 10.—Sperry Messenger tests. Characteristics of U. S. A.-5 wings. Glide at $\frac{V}{nD} = 1.075$

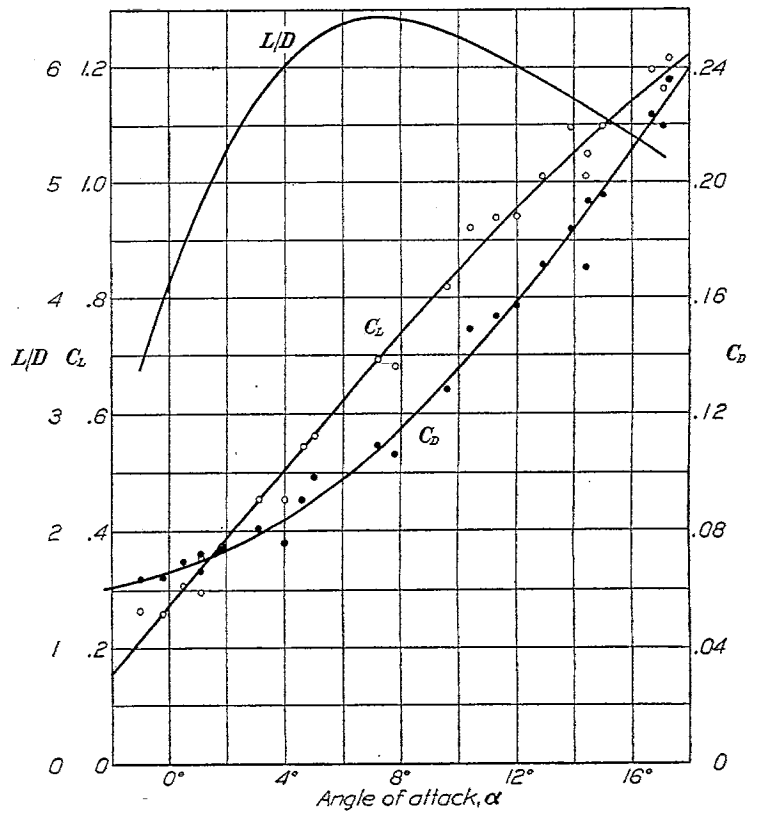

FIG. 11.—Sperry Messenger tests. Characteristics of U. S. A.-27 wings. Glide at $\frac{V}{nD} = 1.075$

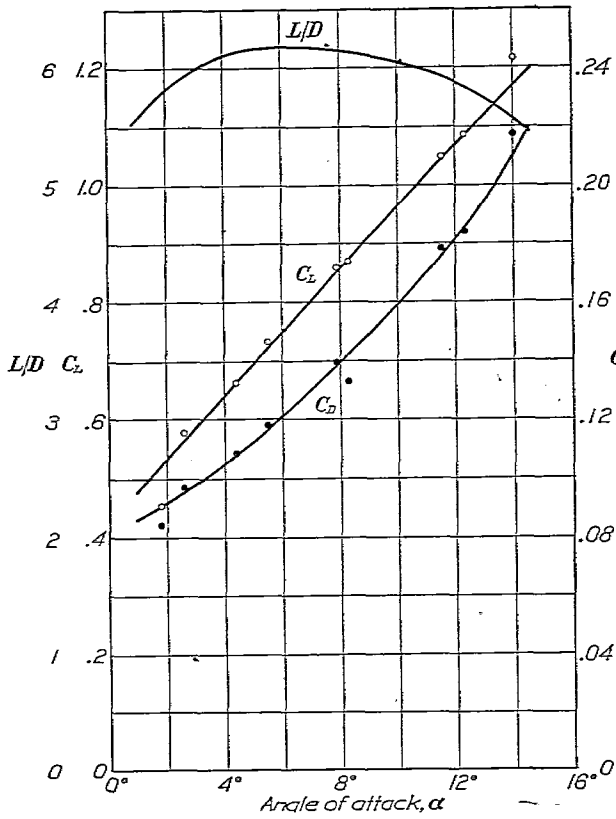

FIG. 12.—Sperry Messenger tests. Characteristics of Göttingen 387 wings. Glide at $\frac{V}{nD} = 1.075$. (Limited data)

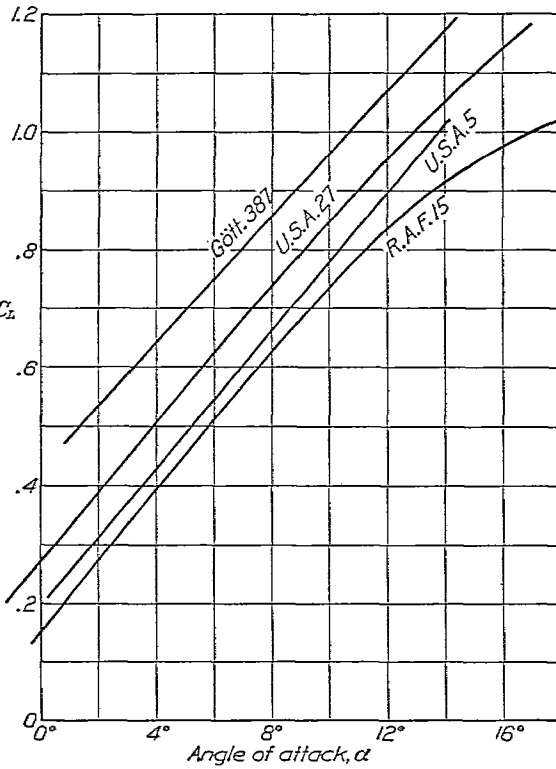

FIG. 13.—Sperry Messenger tests. Lift vs. angle of attack. Glide at $\frac{V}{nD} = 1.075$

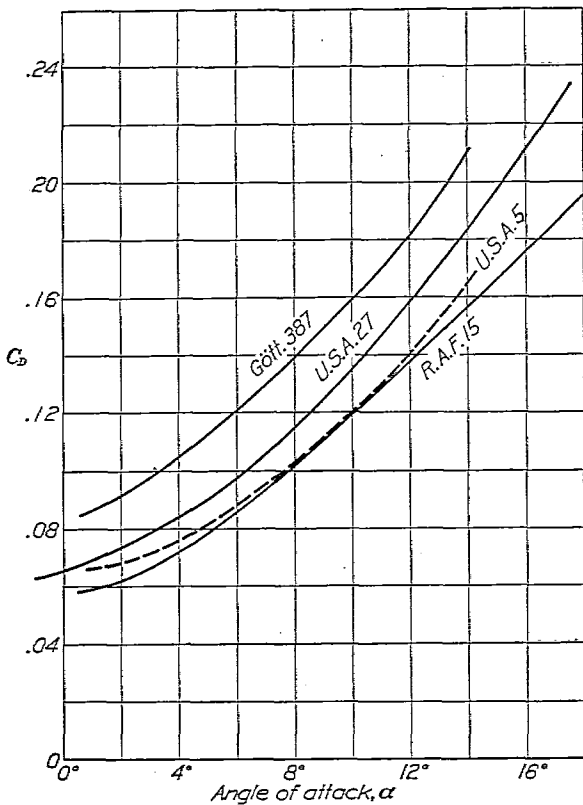

FIG. 14.—Sperry Messenger tests. Drag vs. angle of attack. Glide at $\frac{V}{nD} = 1.075$

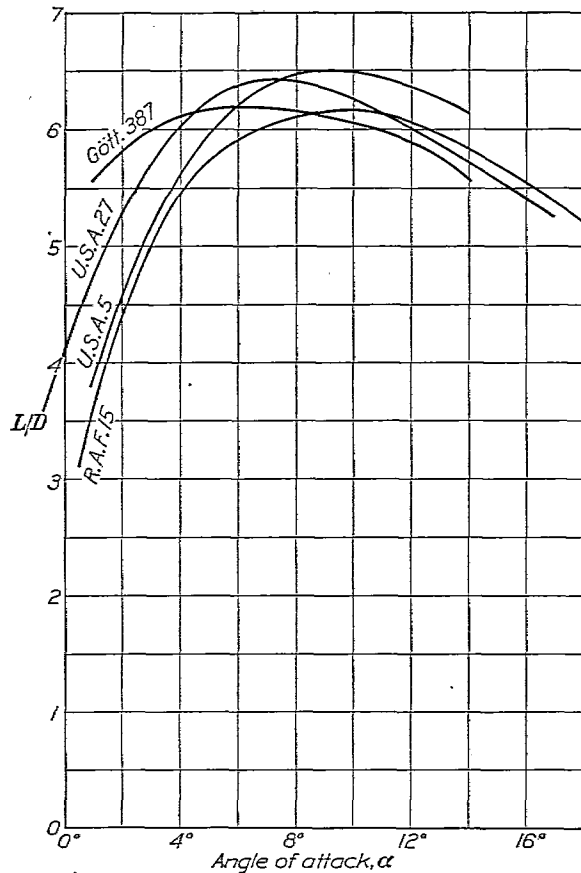

FIG. 15.—Sperry Messenger tests. L/D vs. angle of attack. Glide at $\frac{V}{nD} = 1.075$

TABLE I.—DATA FOR U. S. A.-5 WING
GLIDE TESTS ON SPERRY MESSENGER AIRPLANE

Flight No.	Rm No.	q	P	T	ρ_p	V_T	V_{ind}	R. P. M.	V_{TND}	C_T	T	γ	Sin γ	Cos γ	W	D-T	D	L	C_D	C_L	α	ϕ	
		Dy- namic pres- sure	Baro- metric pres- sure	Tem- pera- ture	Specific weight	True velocity	Indi- cated velocity			Propeller thrust co- efficient $T/\rho V^2 D^2$	Thrust	Flight- path angle			Weight	Appar- ent drag	True drag	Lift	$\frac{D}{qS}$	$\frac{L}{qS}$	Inclina- tion	Angle of attack	Eleva- tor angle
		Lbs. per sq. ft.	Inch. hg.	$^{\circ}C.$	Lbs. per cu. ft.	Ft. per sec.	M. p. h.				Lbs.	Deg.			Lbs.	Lbs.	Lbs.	Lbs.			Deg.	Deg.	Deg.
A	1	16.65	27.6	1	0.0740	120.5	80.6	1,020	1.088	-0.0015	-2.1	10.8	0.1874	0.9823	1,019	191.0	188.9	1,000	0.0765	0.404	7.2	3.6	
	2	22.35	28.0		.0752	138.2	93.5	1,145	1.112	-.0042	-7.9	13.4	.2317	.9728	1,016	235.0	227.1	988	.0685	.298	11.8	1.6	
	3	26.50	27.8		.0746	151.0	102.0	1,242	1.118	-.0048	-10.7	15.2	.2622	.9650	1,013	266.0	255.3	978	.0644	.246	14.5	0.7	
	4	16.90	27.3		.0734	122.0	81.2	1,050	1.070	+.0006	+8	10.7	.1857	.9826	1,010	187.5	188.3	992	.0751	.395	7.2	3.5	
B	5	6.76	26.75	-5	.0735	77.0	51.4	632	1.120	-.0050	-2.8	9.4	.1633	.9866	1,019	166.5	163.7	1,005	.1635	1.000	4.6	14.0	1.5
	6	7.54	27.00		.0743	80.8	54.2	660	1.120	-.0050	-3.2	9.2	.1599	.9871	1,016	162.2	159.0	1,002	.1421	.900	3.0	12.2	1.0
	7	8.84	27.50		.0756	86.8	58.8	740	1.080	-.0006	-0.4	8.9	.1547	.9880	1,013	157.0	156.6	1,000	.1195	.764	1.0	9.9	.5
	8	8.06	27.05		.0743	83.6	56.2	716	1.072	+.0003	+0.2	8.9	.1547	.9880	1,010	156.2	156.4	988	.1311	.835	1.4	10.3	.0
	9	9.36	27.20		.0748	89.6	60.5	745	1.105	-.0034	-2.7	9.1	.1582	.9874	1,007	159.5	156.8	993	.1129	.714	.0	9.1	.3
	10	9.62	27.20		.0748	91.0	61.3	760	1.100	-.0028	-2.3	9.1	.1582	.9874	1,004	159.0	156.7	991	.1100	.696	.0	8.5	.5
	11	10.25	26.80		.0736	94.5	63.3	780	1.110	-.0039	-3.4	9.1	.1582	.9874	1,001	158.2	154.8	989	.1018	.650	-1.6	8.5	-1.7
C	12	20.80	27.4	4	.0729	133.8	89.2	1,140	1.080	-.0006	-1.0	12.3	.2130	.9770	1,019	217.0	216.0	995	.0706	.330	9.5	2.8	
	13	25.25	27.4		.0729	149.2	99.4	1,260	1.090	-.0017	-3.6	14.4	.2487	.9686	1,016	252.5	248.9	986	.0686	.284	13.5	1.9	
	14	21.30	27.4		.0729	137.2	91.4	1,140	1.100	-.0028	-5.1	12.4	.2147	.9767	1,010	216.5	215.4	986	.0681	.311	9.7	2.7	
	15	25.25	28.2		.0750	147.0	99.4	1,260	1.072	+.0003	+1.6	14.4	.2487	.9686	1,007	251.0	251.6	975	.0673	.261	13.0	1.4	
D	16	11.70	27.30	-5	.0750	100.2	67.6	805	1.145	-.0074	-7.3	9.4	.1633	.9866	1,019	166.5	159.2	1,005	.0918	.578	2.6	6.8	.0
	17	14.58	27.30		.0750	111.5	75.5	900	1.140	-.0069	-8.5	10.0	.1736	.9848	1,016	176.0	167.5	1,000	.0776	.463	5.4	4.6	1.0
	18	18.20	27.65		.0768	123.5	84.4	1,000	1.135	-.0065	+10.0	11.9	.2062	.9785	1,013	208.5	199.5	991	.0739	.367	9.0	2.9	1.5
E	19	6.60	27.00	4	.0718	77.0	50.8	643	1.102	-.0031	1.7	9.4	.1633	.9866	1,019	166.3	164.6	1,005	.1680	1.025	-4.6	14.0	2.4
	20	9.88	27.30		.0726	93.5	62.2	800	1.076	.0000	.0	8.8	.1530	.9832	1,016	155.2	155.2	1,002	.1060	.6850	.4	8.4	.0
	21	12.72	27.55		.0732	106.0	70.6	900	1.082	-.0007	.8	9.4	.1633	.9866	1,013	165.5	164.7	1,000	.0872	.5280	3.8	5.6	.5
	22	16.75	27.80		.0738	121.0	80.9	990	1.125	-.0056	8.0	11.0	.1908	.9816	1,010	193.0	185.0	990	.0745	.3980	7.8	3.2	1.0
	23	20.40	27.50		.0730	134.0	89.2	1,128	1.092	-.0020	3.4	12.0	.2079	.9781	1,007	209.0	205.6	984	.0679	.3250	10.0	2.0	1.8

TABLE II.—DATA FOR R. A. F.—15 WING
GLIDE TESTS ON SPERRY MESSENGER AIRPLANE

Flight No.	Run No.	q	P	T	g _p	V _T	V _{ind}	R. P. M.	V _T /nD	C _T	T	γ	Sin γ	Cos γ	W	D-T	D	L	C _D	C _L	α	φ	
		Dyn-amic pres-sure	Baro-metric pres-sure	Tem-pera-ture	Specific weight	True velocity	Indi-cated velocity			Propeller thrust co-efficient $T/\rho V^2 D^2$	Thrust	Flight-path angle			Weight	Appar-ent drag	True drag	Lift	$\frac{D}{qS}$	$\frac{L}{qS}$	Inclina-tion	Angle of attack	Eleva-tor angle
		Lbs. per sq. ft.	Inch. hg.	° C.	Lbs. per cu. ft.	Ft. per sec.	M. p. h.				Lbs.	Deg.			Lbs.	Lbs.	Lbs.	Lbs.			Deg.	Deg.	Deg.
A	1	6.86	27.20	17	0.0690	79.9	51.8	040	1.150	-0.0070	-4.6	10.4	0.1805	0.9886	1,016	183.0	178.4	1,000	0.1751	0.982	-4.6	15.0	+4.0
	2	28.10	27.05	-----	.0710	159.8	104.8	1,275	1.150	-.0079	-18.8	15.5	.2672	.9636	1,013	271.0	252.2	975	.0605	.284	-13.8	1.7	-2.5
	3	28.10	28.32	-----	.0719	158.8	104.8	1,280	1.140	-.0074	-17.6	15.6	.2689	.9632	1,010	271.0	253.4	974	.0608	.233	-14.2	1.4	-2.2
	4	24.70	28.10	-----	.0714	149.2	98.3	1,180	1.165	-.0092	-19.2	13.9	.2402	.9707	1,007	242.0	222.8	978	.0608	.267	-12.0	1.9	-2.0
	5	23.90	27.73	-----	.0704	148.2	98.6	1,190	1.148	-.0077	-15.6	13.9	.2402	.9707	1,004	241.6	226.0	976	.0642	.270	-12.2	1.7	-2.0
	6	20.18	27.80	-----	.0707	135.5	88.8	1,080	1.152	-.0081	-13.8	12.4	.2147	.9767	1,001	215.0	201.2	978	.0673	.327	-9.6	2.8	-1.5
	7	20.80	27.87	-----	.0709	137.5	90.2	1,085	1.165	-.0092	-16.2	12.4	.2147	.9767	998	214.0	197.8	975	.0640	.315	-9.8	2.6	-1.6
	8	7.54	27.73	-----	.0704	83.0	54.3	770	1.140	-.0074	-4.7	9.4	.1633	.9866	995	162.3	158.1	982	.1412	.877	+8.0	12.4	+2.0
	9	9.10	27.87	-----	.0709	90.8	59.6	703	1.190	-.0113	-8.7	9.4	.1633	.9866	992	162.3	153.6	979	.1137	.726	+7.3	9.7	+1.0
B	10	17.70	27.10	14	.0690	128.0	83.2	1,118	1.055	+0.0032	+4.8	11.2	.1942	.9810	1,016	197.2	202.0	1,000	.0768	.380	-7.4	3.8	-1.5
	11	17.80	27.27	-----	.0701	128.0	83.3	1,188	1.088	+0.0047	+7.1	11.1	.1925	.9813	1,013	195.0	202.1	995	.0764	.376	-7.2	3.9	-1.5
	12	13.80	27.42	-----	.0705	112.3	73.4	903	1.140	-.0069	-8.1	10.0	.1736	.9848	1,010	175.5	167.4	994	.0818	.485	-4.3	5.7	-0.9
	13	13.28	27.58	-----	.0709	109.8	72.0	900	1.120	-.0050	-5.6	9.9	.1719	.9851	1,007	173.0	167.4	993	.0850	.505	-4.1	5.8	-0.9
	14	10.15	27.70	-----	.0711	95.7	63.0	795	1.106	-.0035	-3.0	9.2	.1599	.9871	1,004	166.3	163.3	991	.1033	.658	-7.8	8.4	+2.2
	15	10.94	27.62	-----	.0709	99.6	65.4	832	1.102	-.0020	-1.8	9.3	.1616	.9809	1,001	162.0	160.2	989	.0986	.608	-2.0	7.3	-0.0
	16	27.04	28.25	-----	.0701	158.8	108.0	1,280	1.140	-.0069	-15.8	14.6	.2521	.9677	998	252.0	236.2	965	.0588	.240	-13.6	1.0	-3.4
C	17	26.00	28.55	16	.0735	151.0	101.0	1,275	1.090	-.0018	-4.0	14.6	.2521	.9677	1,016	256.0	252.0	982	.0653	.254	-13.1	1.5	-2.0
	18	21.05	28.25	-----	.0720	137.2	90.4	1,175	1.075	-.0000	0	12.1	.2066	.9778	1,013	212.0	212.0	991	.0679	.317	-9.3	2.8	-1.5
	19	18.20	28.25	-----	.0720	127.6	84.4	1,030	1.140	-.0069	-10.6	11.3	.1959	.9806	1,010	197.8	187.2	990	.0692	.306	-7.4	3.9	-1.0
	20	13.25	28.10	-----	.0716	109.1	72.0	915	1.100	-.0029	-3.3	10.2	.1771	.9842	1,007	178.2	174.9	990	.0888	.502	-----	-----	-----
	21	12.48	28.47	-----	.0726	105.2	70.0	875	1.105	-.0034	-3.6	10.0	.1736	.9848	1,004	180.6	177.0	988	.0956	.533	-----	-----	-----
	22	9.88	28.25	-----	.0720	98.9	62.2	772	1.114	-.0044	-3.7	9.4	.1633	.9866	1,001	163.8	160.1	988	.1093	.675	+7.2	9.6	+6.6
	23	8.17	28.40	-----	.0724	85.1	56.5	660	1.190	-.0113	-7.8	9.9	.1719	.9851	998	171.2	163.4	982	.1348	.810	+3.2	13.1	+2.2
D	24	7.33	27.40	15	.0700	82.0	53.5	664	1.188	-.0067	-4.2	10.0	.1736	.9848	1,016	176.2	172.0	1,000	.1571	.925	+4.2	14.2	-----
	25	7.02	28.20	-----	.0721	79.1	52.5	595	1.280	-.0135	-8.0	10.6	.1839	.9829	1,013	186.0	178.0	996	.1708	.955	+4.9	15.5	-----
	26	6.55	27.77	-----	.0708	77.0	50.6	610	1.180	-.0088	-4.9	11.0	.1908	.9816	1,010	192.5	187.6	990	.1931	1.018	+0.8	17.8	-----
	27	7.33	27.60	-----	.0706	81.7	53.5	647	1.100	-.0038	-5.5	10.1	.1754	.9845	1,007	176.5	171.0	982	.1572	.913	+4.0	14.1	-----
	28	7.02	27.83	-----	.0713	79.8	52.5	640	1.145	-.0074	-4.4	10.3	.1788	.9839	1,004	186.0	181.6	988	.1742	.946	+4.6	14.9	-----
	29	6.55	28.43	-----	.0727	76.1	50.6	618	1.134	-.0064	-3.5	10.9	.1891	.9819	1,001	189.5	186.0	982	.1914	1.010	+0.8	17.7	-----

AN AIRPLANE EQUIPPED WITH DIFFERENT SETS OF WINGS

TABLE III.—DATA FOR U. S. A.—27 WING
GLIDE TESTS ON SPERRY MESSENGER AIRPLANE

Flight No.	Run No.	q	P	T	ρp	V_T	V_{ind}	R. P. M.	V_T/nD	C_T	T	γ	$\sin \gamma$	$\cos \gamma$	W	$D-T$	D	L	C_D	C_L	α	ϕ	
		Dy- namic pres- sure	Baro- metric pres- sure	Tem- pera- ture	Specific weight	True velocity	Indi- cated velocity			Propeller thrust co- efficient $T/\rho V^2 D^2$	Thrust	Flight- path angle			Weight	Appar- ent drag	True drag	Lift	$\frac{D}{qS}$	$\frac{L}{qS}$	Inclina- tion	Angle of attack	Eleva- tor angle
		Lbs. per sq. ft.	Inch. hg.	$^{\circ}$ C.	Lbs. per cu. ft.	Ft. per sec.	M. p. h.				Lbs.	Deg.			Lbs.	Lbs.	Lbs.	Lbs.			Deg.	Deg.	Deg.
A	1	5.72	27.45	15	0.0702	72.4	47.2	600	1.112	-0.0041	-2.0	10.7	0.1857	0.9826	1,083	192.0	190.0	1,016	0.2235	1.195	+6.0	+16.7	+6.0
	2	6.50	27.75		.0710	76.8	50.3	638	1.110	-.0039	-2.1	10.0	.1736	.9848	1,080	179.0	186.9	1,013	.1936	1.050	4.5	+16.7	4.8
	3	7.28	27.50		.0704	81.6	53.3	693	1.078	-.0063	-.2	9.3	.1616	.9869	1,027	166.0	165.8	1,012	.1535	.938	2.0	11.3	3.0
	4	18.20	27.22		.0722	127.5	84.2	1,095	1.070	+.0006	+.9	11.2	.1942	.9816	1,024	199.0	199.9	1,008	.0741	.373	-9.4	+1.8	.5
	5	21.85	27.53		.0705	141.0	92.4	1,210	1.074	-.0000	.0	12.8	.2215	.9751	1,021	226.0	226.0	.998	.0698	.308	-12.3	+5.0	.0
B	6	25.60	27.96		.0716	151.2	99.8	1,275	1.092	-.0025	-5.4	14.0	.2419	.9703	1,018	246.0	240.6	.999	.0636	.264	-15.0	-1.0	-7.7
	7	5.62	27.82	15	.0711	71.1	46.8	620	1.058	+.0021	+1.0	10.9	.1891	.9820	1,063	196.0	197.0	1,015	.2360	1.216	+6.4	+17.3	+7.5
	8	6.24	27.65		.0703	78.5	49.4	660	1.048	-.0033	1.7	9.4	.1633	.9866	1,030	168.5	170.2	1,016	.1838	1.096	4.5	13.9	4.7
	9	6.76	27.52		.0705	85.8	51.4	680	1.062	-.0017	1.0	9.6	.1668	.9860	1,027	171.3	172.3	1,013	.1714	1.010	3.3	12.9	3.9
	10	8.06	27.59		.0703	95.5	62.4	760	1.040	-.0045	3.1	9.0	.1564	.9877	1,024	160.5	163.6	1,010	.1490	.920	1.4	10.4	2.7
	11	9.95	27.52		.0710	104.0	68.4	800	1.035	-.0023	-1.9	9.0	.1564	.9877	1,021	160.0	158.1	1,010	.1067	.680	-1.2	7.8	1.7
	12	11.95	27.77		.0700	117.0	76.2	900	1.063	+.0015	+1.5	9.2	.1599	.9871	1,021	162.8	164.3	1,006	.0986	.563	-4.2	5.0	1.5
	13	14.88	27.37		.0712	130.0	84.2	1,000	1.076	-.0060	-10.3	10.3	.1788	.9839	1,015	178.6	178.6	1,000	.0809	.453	-7.2	3.1	1.2
C	14	5.88	27.3	9	.0715	73.0	47.9	660	1.020	+.0073	+3.6	10.5	.1822	.9833	1,033	188.5	192.1	1,015	.2198	1.162	+6.6	17.1	5.7
	15	6.76	27.4		.0715	78.1	51.4	720	.998	-.0107	6.1	9.2	.1599	.9871	1,030	164.9	171.0	1,016	.1702	1.010	5.2	14.4	3.5
	16	8.32	27.5		.0715	86.3	57.0	780	1.018	-.0075	5.3	8.6	.1495	.9888	1,027	153.5	158.8	1,012	.1286	.819	1.0	9.6	2.7
	17	15.00	27.4		.0715	116.2	76.5	1,000	1.070	-.0066	-7.7	9.5	.1650	.9863	1,024	169.0	169.7	1,010	.0761	.453	-5.5	4.0	.8
	18	22.65	27.5		.0722	142.8	94.0	1,200	1.092	-.0020	-3.8	12.9	.2233	.9748	1,021	228.0	224.2	.99	.0606	.295	-11.8	1.1	.0
D	19	6.24	27.6	9	.0722	74.5	49.4	660	1.040	+.0045	+2.4	10.0	.1736	.9848	1,033	179.0	181.4	1,016	.1959	1.097	+5.0	15.0	5.00
	20	7.28	27.7		.0722	80.4	53.3	700	1.058	-.0020	1.2	9.4	.1633	.9865	1,030	168.3	169.5	1,015	.1570	.940	2.6	12.0	3.30
	21	9.95	27.6		.0722	93.8	62.0	800	1.073	-.0065	-4.4	9.0	.1564	.9876	1,027	151.0	160.6	1,013	.1094	.692	-1.8	7.2	2.40
	22	12.45	28.2		.0737	104.5	69.8	900	1.070	+.0006	+.6	9.4	.1633	.9865	1,024	167.3	107.9	1,010	.0907	.545	-4.8	4.6	1.50
	23	19.00	28.2		.0737	129.0	86.0	1,100	1.078	-.0000	-	11.5	.1993	.9799	1,021	204.0	204.6	1,000	.0725	.355	-10.4	1.1	.60
	24	25.75	27.9		.0720	151.0	100.0	1,300	1.068	+.0008	+1.7	13.8	.2856	.9711	1,018	243.0	244.7	.990	.0641	.259	-14.0	-2.2	-6.0

TABLE IV.—DATA FOR GÖTTINGEN 387 WING
GLIDE TESTS ON SPERRY MESSENGER AIRPLANE

Flight No.	Run No.	q	P	T	ρp	V_T	V_{ind}	R. P. M.	V_T/nD	C_T	T	γ	$\sin \gamma$	$\cos \gamma$	W	$D-T$	D	L	C_D	C_L	α	ϕ	
		Dy- namic pres- sure	Baro- metric pres- sure	Tem- pera- ture	Specific weight	True velocity	Indi- cated velocity			Propeller thrust co- efficient $T/\rho V^2 D^2$	Thrust	Flight- path angle			Weight	Appar- ent drag	True drag	Lift	$\frac{D}{qS}$	$\frac{L}{qS}$	Inclina- tion	Angle of attack	Eleva- tor angle
		Lbs. per sq. ft.	Inch. hg.	$^{\circ}$ C.	Lbs. per cu. ft.	Ft. per sec.	M. p. h.				Lbs.	Deg.			Lbs.	Lbs.	Lbs.	Lbs.			Deg.	Deg.	Deg.
A	1	6.86	28.15	25	0.0695	79.8	51.8	670	1.095	-0.0023	-1.33	9.7	0.1635	0.9857	1,082	182.8	181.5	1,068	0.1784	1.060	1.8	11.5	4.0
	2	8.32	28.30		.0698	87.5	57.0	687	1.170	-.0097	-6.82	9.6	.1668	.9860	1,077	179.5	172.7	1,060	.1398	.860	1.7	7.9	1.0
	3	9.72	28.50		.0704	94.2	61.6	765	1.130	-.0059	-4.85	9.4	.1633	.9866	1,072	175.2	170.4	1,058	.1182	.733	3.9	5.5	.3
	4	10.68	28.40		.0702	98.8	64.5	810	1.120	-.0050	-4.50	9.5	.1650	.9863	1,067	176.0	171.5	1,050	.1084	.663	5.1	4.4	-5
	5	12.20	28.40		.0702	106.0	69.0	884	1.105	-.0034	-3.51	9.8	.1702	.9854	1,062	181.0	177.5	1,048	.0980	.578	7.2	2.6	-1.0
	6	15.32	28.50		.0704	118.6	77.5	986	1.105	-.0034	-4.41	10.7	.1857	.9826	1,057	196.0	191.6	1,038	.0841	.455	-8.0	1.8	-1.5
B	7	5.98	28.40	27	.0696	74.4	48.4	625	1.095	-.0023	-1.16	10.2	.1771	.9842	1,098	194.5	193.3	1,080	.2176	1.218	3.8	14.0	5.3
	8	6.66	28.50		.0700	78.4	51.0	595	1.210	-.0128	-7.20	10.0	.1736	.9848	1,093	189.8	182.6	1,078	.1845	1.088	2.3	12.3	3.5
	9	8.32	28.70		.0704	87.5	57.0	693	1.150	-.0079	-5.50	9.0	.1564	.9877	1,088	189.8	164.8	1,072	.1330	.870	-7.7	8.3	1.9