REPORT No. 300

**THE TWENTY-FOOT PROPELLER RESEARCH TUNNEL
OF THE NATIONAL ADVISORY COMMITTEE
FOR AERONAUTICS**

By **FRED E. WEICK** and **DONALD H. WOOD**
Langley Memorial Aeronautical Laboratory

REPORT No. 300

THE TWENTY-FOOT PROPELLER RESEARCH TUNNEL OF THE NATIONAL ADVISORY COMMITTEE FOR AERONAUTICS

By FRED E. WEICK and DONALD H. WOOD

SUMMARY

This report describes in detail the new propeller research tunnel of the National Advisory Committee for Aeronautics at Langley Field, Va. This tunnel has an open jet air stream 20 feet in diameter in which velocities up to 110 M. P. H. are obtained. Although the tunnel was built primarily to make possible accurate full-scale tests on aircraft propellers, it may also be used for making aerodynamic tests on full-size fuselages, landing gears, tail surfaces, and other aircraft parts, and on model wings of large size.

INTRODUCTION

The need of an accurate means for making aerodynamic measurements on full-size aircraft propellers has been realized for some time. Tests on model propellers in wind tunnels are not entirely satisfactory because the deflection of the model is different from that of a similar full-scale propeller, which introduces a rather large error in some cases. The difference in scale and tip speed between the model and full-scale propeller is also a cause of error. Full-scale flight tests on propellers are made, of course, under the correct conditions, but at the present time they can not be made with sufficient accuracy.

In the spring of 1925 the design and construction of a propeller research wind tunnel to fill this need for full-scale tests was started by the National Advisory Committee for Aeronautics. It was completed during the summer of 1927 and testing has been carried on since that time. The tunnel is of the open-jet type with an air stream 20 feet in diameter. This is large enough to permit the mounting of a full-sized airplane fuselage with its engine and propeller. The open-jet type is particularly suitable for testing propellers because no corrections are required for tunnel-wall interference. (References 4 and 5.) Also, since with the open-jet type the inside of the experiment chamber is free from restricting walls, the installation of the objects to be tested is relatively simple.

This wind tunnel makes it possible for the first time to make aerodynamic tests with laboratory accuracy on full-scale aircraft propellers and also on full-scale fuselages, engine cowlings, cooling systems, landing gears, tail surfaces and other airplane parts. Full-scale tests of wings are not, of course, possible in a 20-foot air stream, but large model wings (12 feet in span) can be tested at comparatively high values of Reynolds Number.

Dr. Max M. Munk is responsible for the general arrangement of the propeller research tunnel, and the detail design and construction were carried out under the direction of Mr. E. W. Miller of the laboratory staff.

DESCRIPTION OF THE TUNNEL

GENERAL

The propeller research tunnel of the National Advisory Committee for Aeronautics is located at Langley Field, Va., on a plot adjacent to the committee's other research equipment. Figure 1 is a diagrammatic sketch indicating the general arrangement of the tunnel and Figure 2 illustrates the exterior appearance.

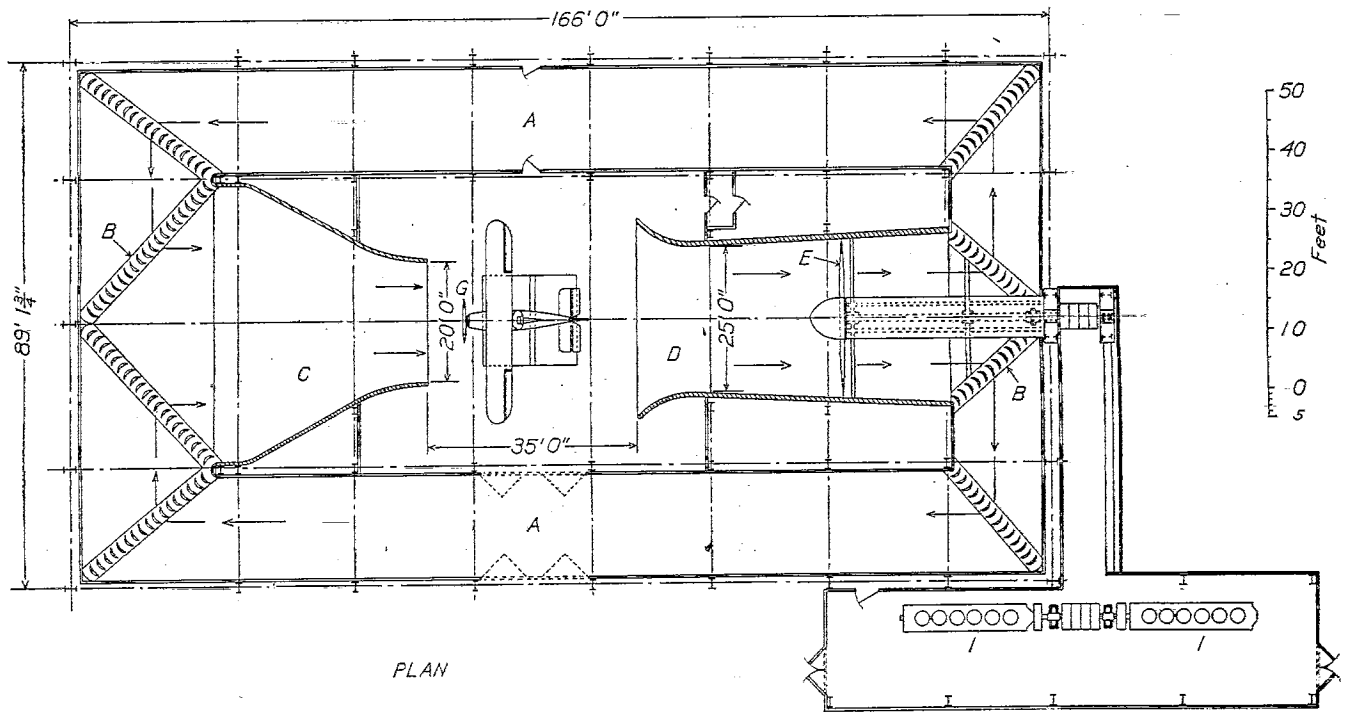

PLAN

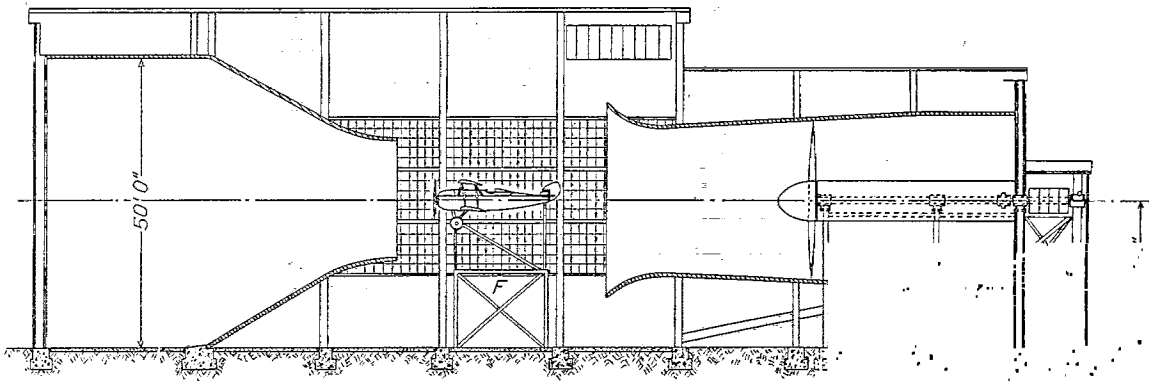

LONGITUDINAL SECTION

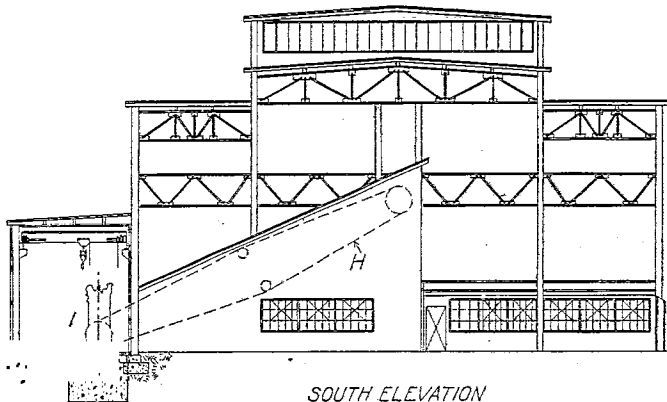

SOUTH ELEVATION

- A, Return passage
- B, Guide vanes
- C, Entrance cone
- D, Exit cone
- E, Circulating fan
- F, Balance
- G, Test propeller
- H, Rope drive
- I, Diesel engines

FIG. 1

The tunnel proper is a wood walled steel-framed structure 166 feet long and 89 feet wide, having a maximum height of 56 feet. The walls are of 2 inch by 6 inch tongued and grooved pine sheathing attached to steel columns with wooden nailers. Except for the fact that the walls are on the inside of the framing only and that the heights vary from point to point, standard structural practice is followed.

The tunnel (fig. 1) is of the open-throat, closed test chamber, return passage type. The direction of the air flow is indicated by arrows. The air is drawn across the test chamber into the exit cone by a propeller fan. After passing through the fan the air column divides, passes through successive sets of guide vanes at the corners, and returns through the side passages to the entrance cone. The areas of the passages are varied in the case of the exit cone by varying the diameter, and of the return passages by sloping the roof and floor, so that the velocity of the moving air is gradually decreased at the large end of the entrance cone to about one-eighth that through the test chamber. It is then rapidly accelerated in passing through the entrance cone.

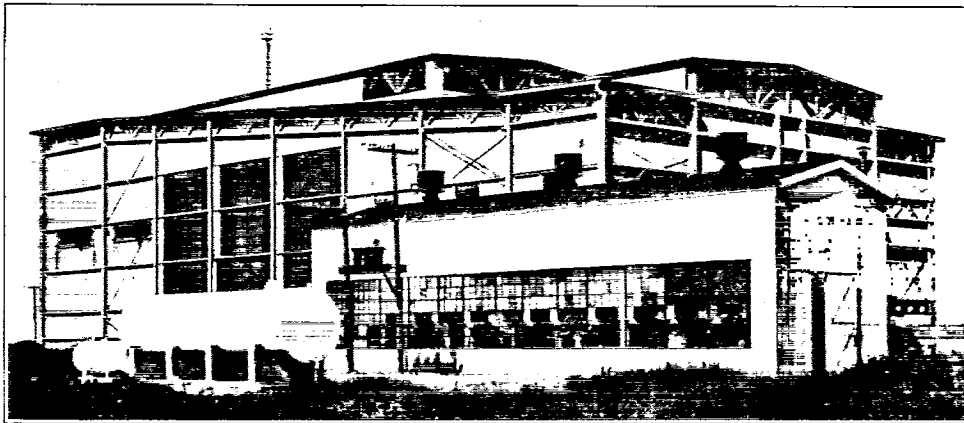

FIG. 2

TEST CHAMBER

The test chamber is about 50 by 60 by 55 ft., located, as shown in Figure 1, near the center of the tunnel structure. Large windows in the east and west walls afford ample light. Doors open out of the west wall to permit the movement of material to and from the test chamber. An electric crane traveling along a roof truss is useful in lifting loads about the chamber and onto the balance. Electrical outlets for light and power are provided at convenient points.

ENTRANCE CONE

The entrance cone (fig. 3) is of 50 ft. square section at the large end, changing to 20 ft. diameter in its length of 36 ft. It is constructed of a double layer of $\frac{3}{4}$ in. by 2 in. sheathing bent, fitted, and nailed to wood forming rings. These, in turn, are bolted to angle clips riveted to I-beams bent to proper shape. A built-up wood ring forms the end of the cone. At the large end the cone runs into the return passage on a gradual curve.

EXIT CONE

The exit cone (fig. 4) is similar in construction to the entrance cone. It is circular in section from the mouth of the bell in the test chamber to the fan. The cone has a diameter of 33 ft. at the mouth of the bell, reducing to 25 ft. at the test chamber wall and then increasing with a 7° included angle to 28 ft. in diameter at the fan. From the fan a gradual change is made to 30 ft. square at the return passage. The total length of the exit cone is 52 ft.

GUIDE VANES

Guide vanes (fig. 5) are located, as shown in Figure 1, at each point of change of direction of the air stream. These consist of metal covered wood framed curved shapes built up in sections 5 ft. long. Rounded leading edges and pointed trailing edges are of wood. The vanes are so proportioned that the free area between them is about a mean of the passage areas before and behind them. Streamlined wood separators run diagonally across the corners and act as stiffeners and supports for each tier of vane sections. It may also be noted in Figure 5 that cross bracing in the return passages is streamlined in the direction of flow.

FAN

Circulation of air is accomplished with a 28 ft. diameter propeller type fan. (Fig. 6 and fig. 1.) It consists of eight cast, heat-treated, aluminum-alloy blades screwed into a cast steel hub and locked in place by means of wedge rings which are forced between the blade shanks

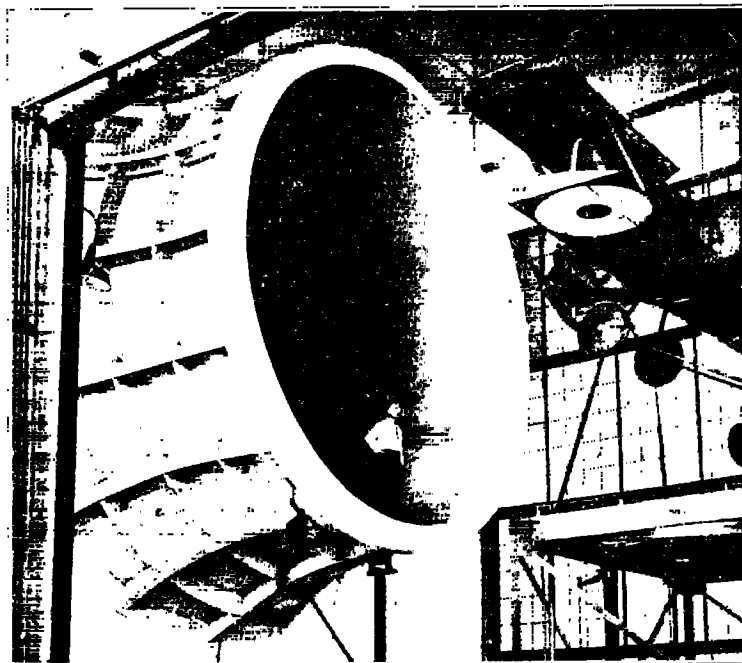

FIG. 3

and the hub. This makes it possible to change the pitch to adapt the fan to the driving engine characteristics or to secure different air speeds with the same engine speed. At present 100 M. P. H. is obtained with 330 R. P. M. of the engines and fan. The weight of each blade is 600 pounds and the total weight of the fan is about $3\frac{1}{2}$ tons.

A steel framed sheet aluminum spinner 7 ft. in diameter is attached to the hub. This fairs into the cylindrical propeller shaft housing.

DRIVE SHAFT

The fan hub is keyed on to the tapered end of an 8-in. solid steel shaft running back through the exit cone and return passage. This shaft is supported on four plain, collar oiled, bearings and one combination plain radial bearing and deep groove ball thrust bearing. The latter is located at the end of the shaft opposite the propeller. The bearings are supported, in turn, on steel I-beam A frames resting on spread footings in the ground below the exit cone.

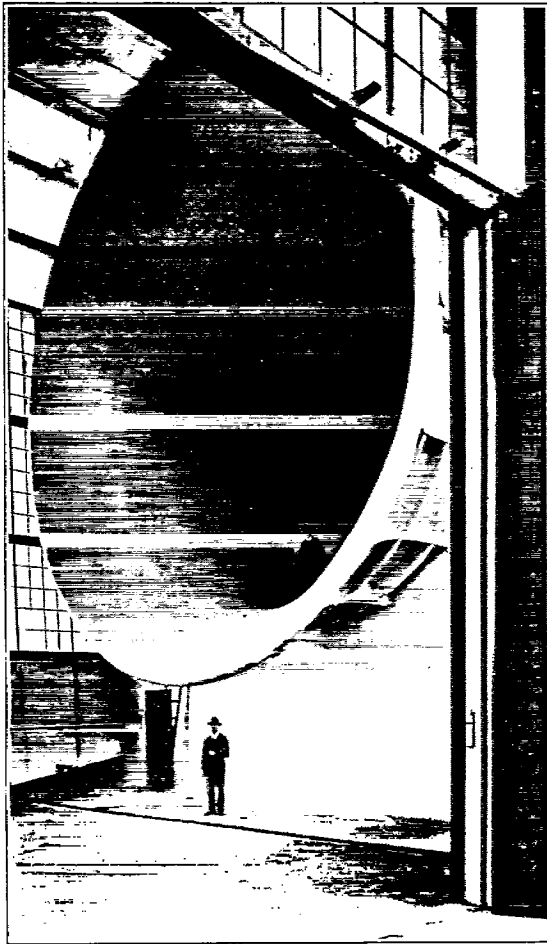

FIG. 4

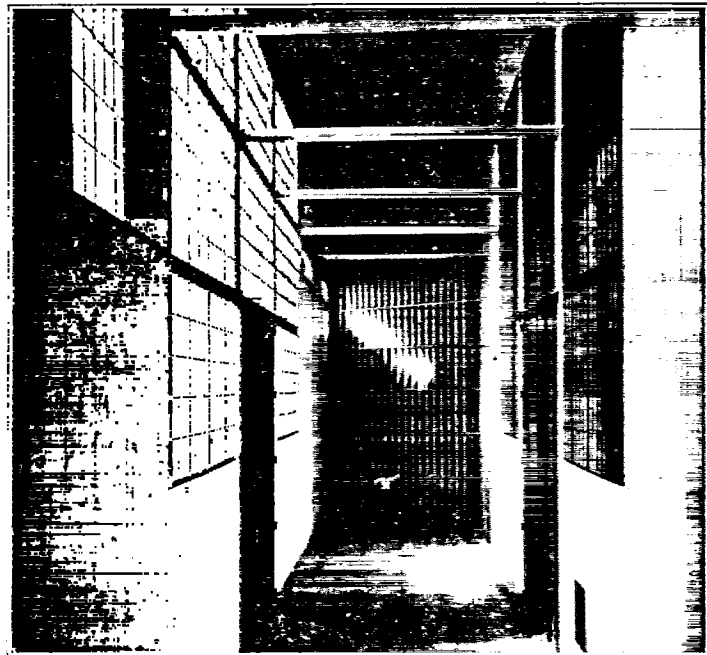

FIG. 5

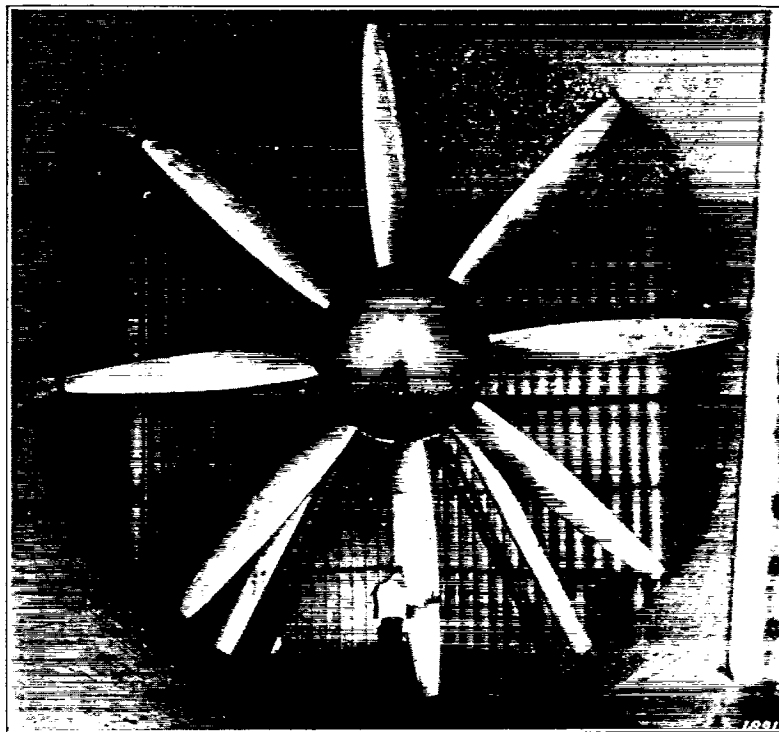

FIG. 6

The shaft and bearing bracing are surrounded by a cylindrical sheet steel fairing on wood formers of the same diameter as the fan spinner. The legs of the A frames are also suitably faired.

POWER PLANT AND TRANSMISSION

Because of local conditions it was found advisable to use Diesel engines rather than electric motors to furnish power for circulating the air through the tunnel. Two Diesel engines, which had been removed from a submarine, were furnished by the Navy Department—

These engines are full Diesel M. A. N. type, 6 cylinder, 4 cycle, single acting, rated at 1,000 HP. each at 375 R. P. M. After due consideration, it was decided to install these end to end as they had been in the submarine, using the existing flywheels and clutches, spacing them far enough apart to allow the installation of a driving sheave between. The location of the engine room is shown in Figure 1, with the engine and sheave position indicated. The

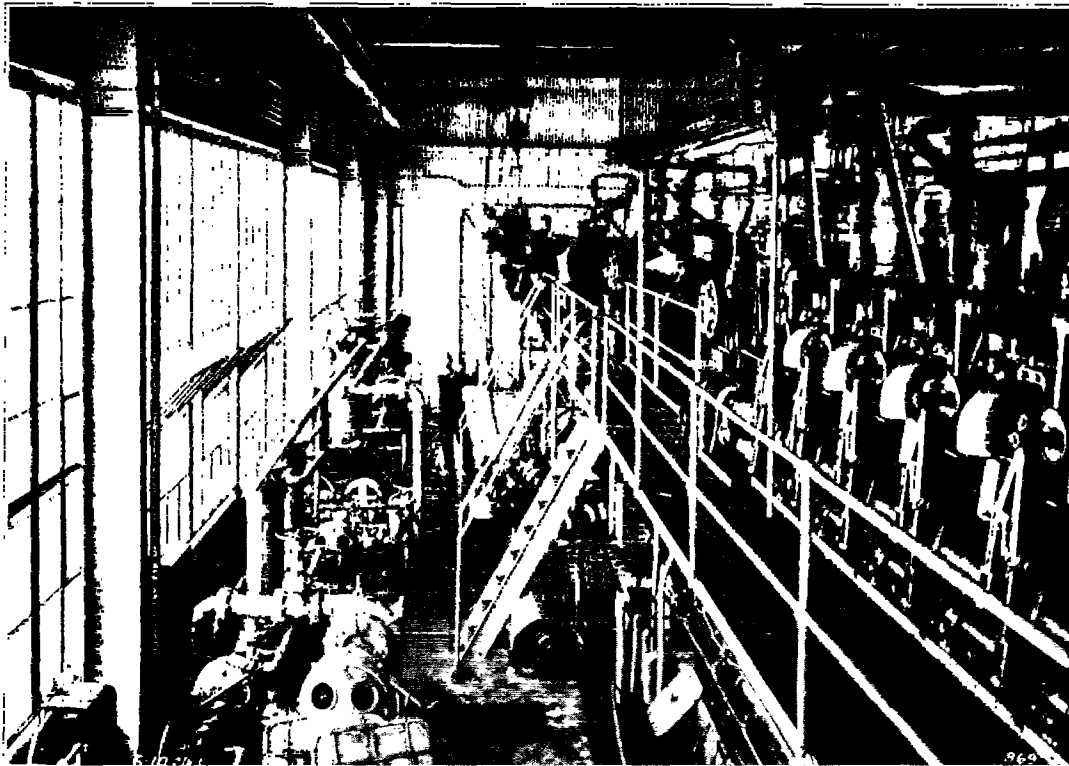

FIG. 7

auxiliary machinery is arranged on the opposite side of the room from the engines. Figure 7 is a general view of the engine room.

Power is transmitted from the driving sheave to a similar sheave located forward of the thrust bearing on a part of the fan shaft extending through the main tunnel wall. Forty-four "Texrope" V-belts are used with two adjustable grooved idler pulleys located as shown in the end view, Figure 1. The transmission ratio is 1 to 1. The belt pull is carried on a suitable steel structure and the whole framing is roofed over and sided with a protected corrugated metal. This same material is a covering for the engine room proper, rendering this part of the installation practically fireproof.

BALANCE

The testing of full size airplane fuselages necessitated the design of a new type balance. This, as shown in Figures 8 and 9, consists essentially of a triangular frame A of steel channels and gussets resting on tubular steel posts B, which in turn bear on the platforms of ordinary

beam scales *C*. Double knife edges are provided at both ends of these posts. The rear post of the frame is on the longitudinal center line of the balance and the forward posts are at equal distances (5 ft.) on either side. The sum of the net readings on all three balances is the lift. The pitching moment is computed from the sum of the front balance readings and from the rear balance reading. Since the rear balance is on the longitudinal axis, the rolling moment is computed from the net readings on the front balances.

At *D* are located knife edges connected to tie rods *E* running forward to a bell crank *G* and a counterweight *H*, and aft to a bell crank *F* and a post *I* resting on the scale *T*. A forward pull or thrust on the frame produces a down force on the post or an increase in load on the scale *T*. The counterweight *H* produces an initial load on the scale *T* and consequently a drag or backward force is measured as a diminution of load on the scale. The counterweight

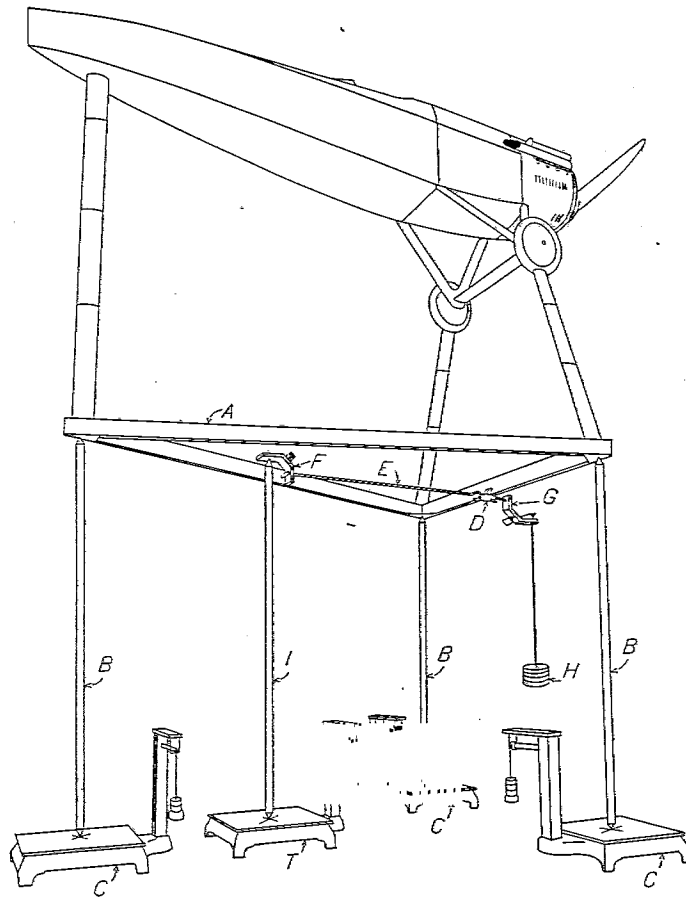

FIG. 8

consists of several 50-lb. units and can be easily adapted to the range of thrusts and drags expected during any one test.

The fixed knife edges on the bell cranks are seated on blocks bolted to a rectangular steel frame rigidly fastened to the floor, as shown in Figure 9. In addition, this frame is provided with knife edges, links, and counterweights which hold the triangular frame in a fixed lateral position. Screws are also provided for raising the triangular frame from the knife edges while working on the attached apparatus. A stairway at the rear and a grating floor facilitate work on the supports and apparatus mounted on the balance.

At each corner of the triangular frame are ball ended steel tubes, adjustable in length and angle, which support the body under test. The forward tubes, in the case of a fuselage with landing gear, have a fitting at the upper end which clamps the axle of the landing gear.

The rear post has a ball-and-socket attachment to the fuselage. The drag of these supports is reduced by streamline fairings which also serve to cover wires and fuel and water lines running to the fuselage.

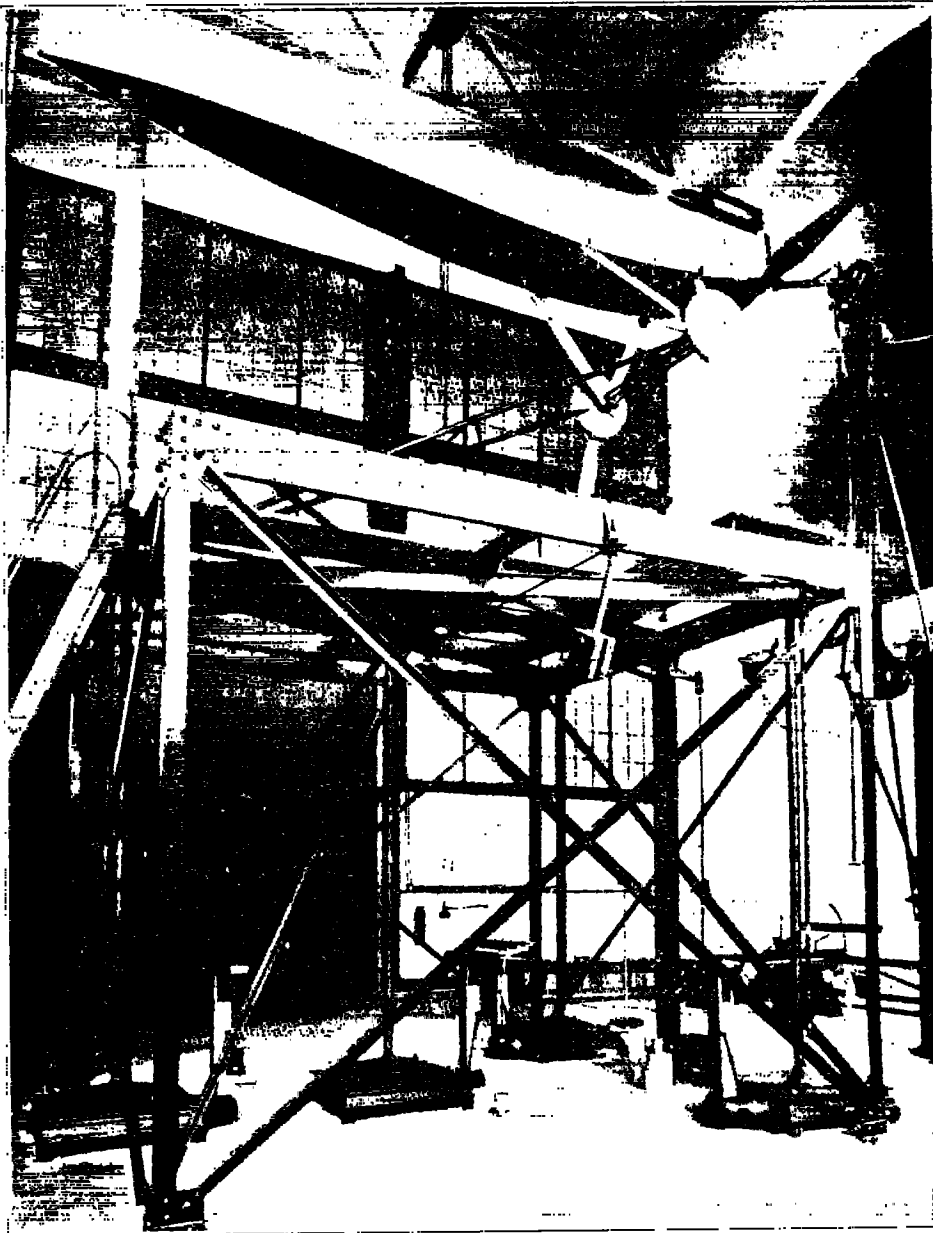

FIG. 9

TORQUE DYNAMOMETER

As the engine power is one of the major variables determining the propeller characteristics, a test fuselage has been developed which allows the engine driving the propeller to be mounted on a dynamometer and the torque to be measured directly.

As shown in Figure 10, this is a heavy angle and strap steel frame so shaped that it can be slipped inside a standard airplane fuselage and supported by suitable blocking. At its forward end a steel casting is fixed carrying two large ball bearings and an extension shaft and plate. An airplane engine can be mounted on this plate. Its torque, which is carried through

the plate and shaft and a special linkage, is read on a dial scale mounted farther back in the fuselage. This dial reads directly in lb. ft. up to 2,000 lb. ft. and a total of 4,000 lb. ft. may be obtained with a counterweight. A double link system renders the operation independent of the direction of engine rotation.

Figure 11 shows a VE-7 airplane mounted on the test fuselage with an E-2 engine on the plate. The radiator is mounted independently of the engine and is not used for cooling. Cooling water is supplied and returned through rubber hose running back through the fuselage and down the rear post to the floor. Figure 12 shows the dial in the rear cockpit.

To reduce the fire hazard and to simplify installation, fuel is supplied from a small tank located on the outer wall of the tunnel, feeding by gravity to the engine carburetor. The gravity tank is filled from a large storage tank by an electric gear pump which is started and stopped by an automatic float switch in the gravity tank.

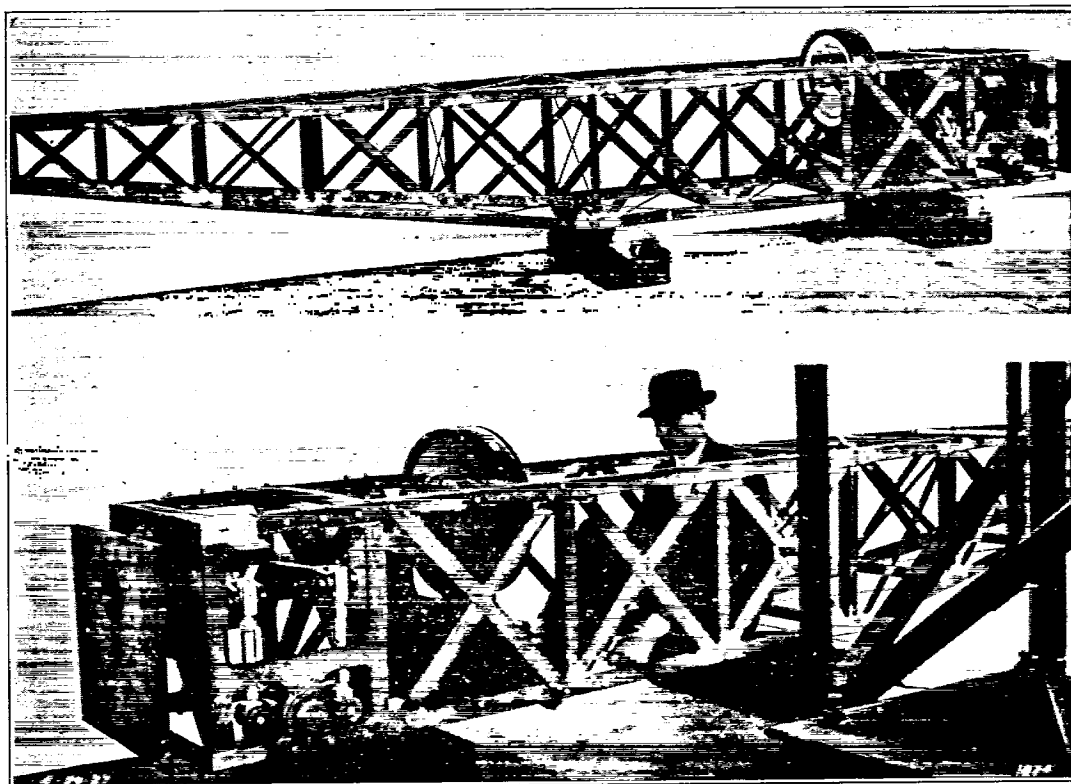

FIG. 10

PROPELLER BLADE DEFLECTION

Propeller blade deflections are measured as follows. A telescope with cross hairs, in conjunction with a prism, is mounted on a lathe bed beneath the propeller being tested. One blade of the propeller at a time is painted black and a black background is painted on the ceiling. Two lights are arranged so that their beams strike the propeller blade. On sighting through the telescope no image will be seen when the black blade passes the black background; but when the white or bright metal blade passes, a line of the leading or trailing edge will appear. By locating the cross hairs successively on these lines and reading the distance moved it is possible to compute the angular deflection of the propeller blade at any given radius. Further development of this apparatus is in process.

MANOMETER

For routine testing, velocities are calculated from the readings of an N. A. C. A. micro-manometer, one side of which is connected to plates set in the walls of the return passage and entrance cone, and the other side open to the air in the test chamber.

SPEED REGULATOR

An air-speed regulator has been developed to insure a uniform dynamic pressure, but to date its use has not been found necessary.

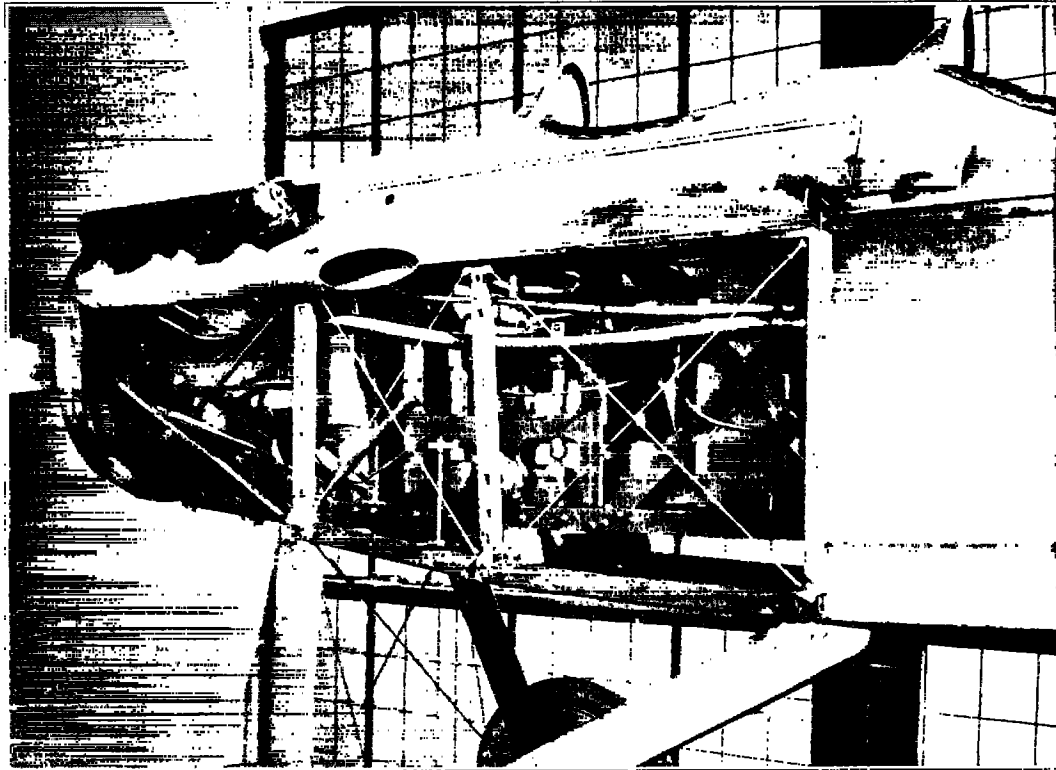

FIG. 11

ENGINE STARTER

For starting an airplane engine mounted on the balance, an electric starter is secured to the entrance cone shown in Figures 12 and 13. A hollow shaft with a pin meshing with a dog on the propeller shaft is driven by means of a chain from an electric motor. The whole unit is arranged to swing down clear of the air stream during a test.

CALIBRATIONS

A velocity survey has been made over the entire cross section of the air stream at a point about 6 ft. back of the entrance cone edge. Seventy-nine points were taken at 2 ft. intervals. The velocity without a honeycomb or air straightener was found to be constant within 1 per cent over the test area. This is attributed to the large reduction of area in the entrance cone. Large variations of velocity at the entrance to the cone are greatly reduced by the rapid acceleration through it. In consequence, while provision was made in the structure for the installation of a honeycomb, none has been deemed necessary.

The wall plates and manometer are calibrated from time to time against a group of Pitot tubes set in the air stream. These are attached to a movable frame to which one or more Pitot

tubes may be attached and the velocity at any point in the air stream determined without a special installation. In particular, this apparatus is used to measure the velocities in the plane of the airplane propeller.

The tunnel was designed to give a velocity of 100 M. P. H. with an energy ratio of 1.2 based on the power input to the fan. A velocity of 110 M. P. H. has been obtained indicating an energy ratio higher than that assumed.

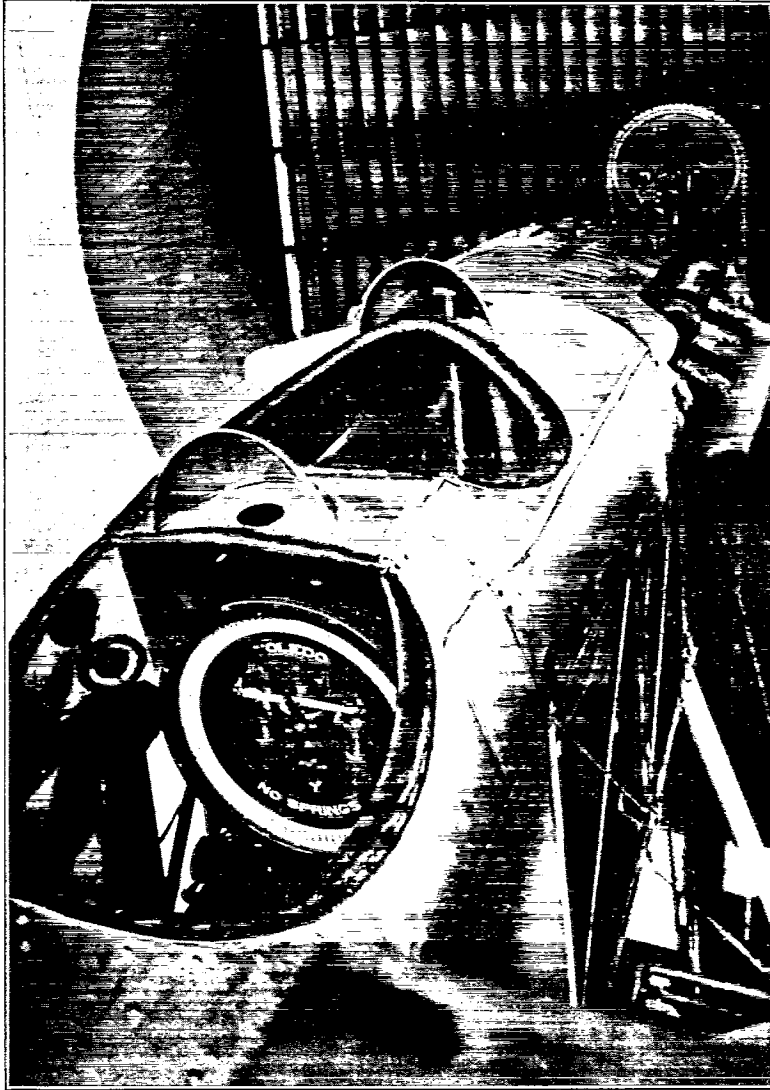

FIG. 12

Figure 13 is a view in the test chamber during a standard propeller test. Balances, manometer and deflection apparatus are shown in operation. An observer stationed in the fuselage to control the engine and read the torque scale does not appear in this view.

SOME RESULTS

A considerable amount of testing has already been accomplished since operation began in July, 1927. Figure 14, taken from Technical Note No. 271 (Reference 1), indicates the proportional drag of various parts of the Sperry Messenger airplane fuselage. The propeller research tunnel is particularly adapted to full scale tests of this nature. Figure 15 shows the characteristics of Propeller I, previously tested in model form at Stanford University, and in

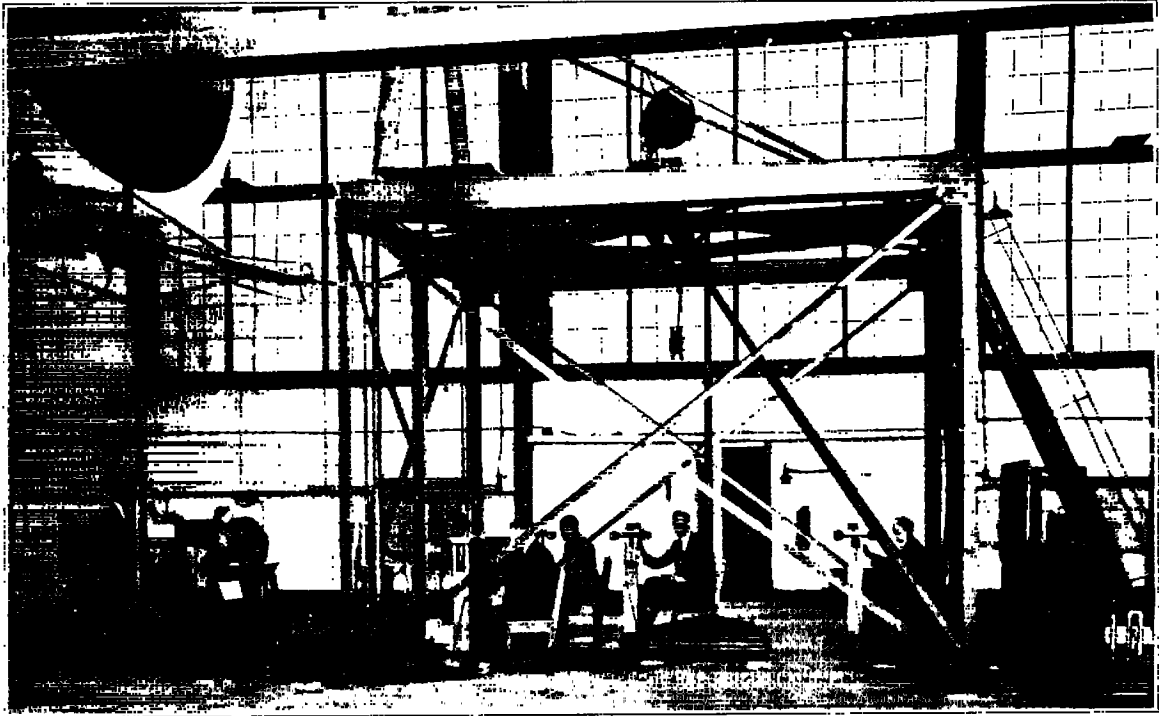

FIG. 13

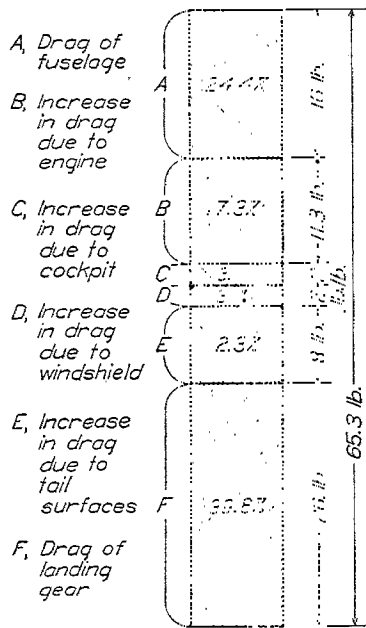

FIG. 14

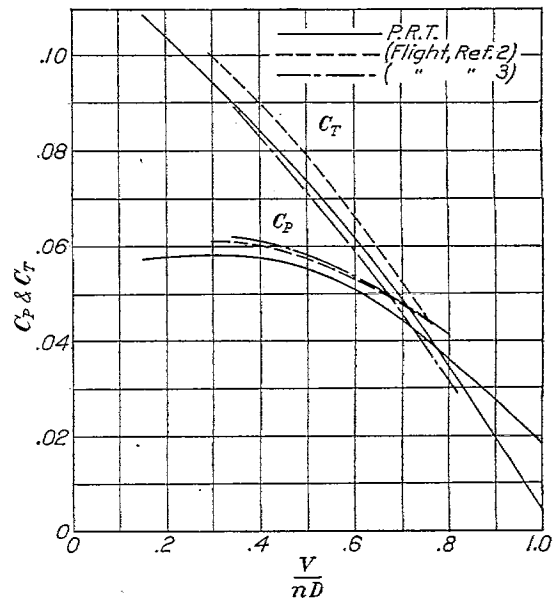

FIG. 15

two separate flight tests. (References 2 and 3.) Curves from these tests are given for comparison. Attention is called to the inaccuracy of flight data mentioned in the introduction to this paper. Tests of wings of 12 ft. span have also been made at speeds up to 100 M. P. H. A comparatively high Reynolds Number is thus attained. Figure 16 is a view of a wing set up for test. A comprehensive program of tests to determine the effect of propellers on air-cooled engines operating in front of various types of fuselages with several shapes of cowling is now in progress. The effect of these bodies on the propeller is also being determined.

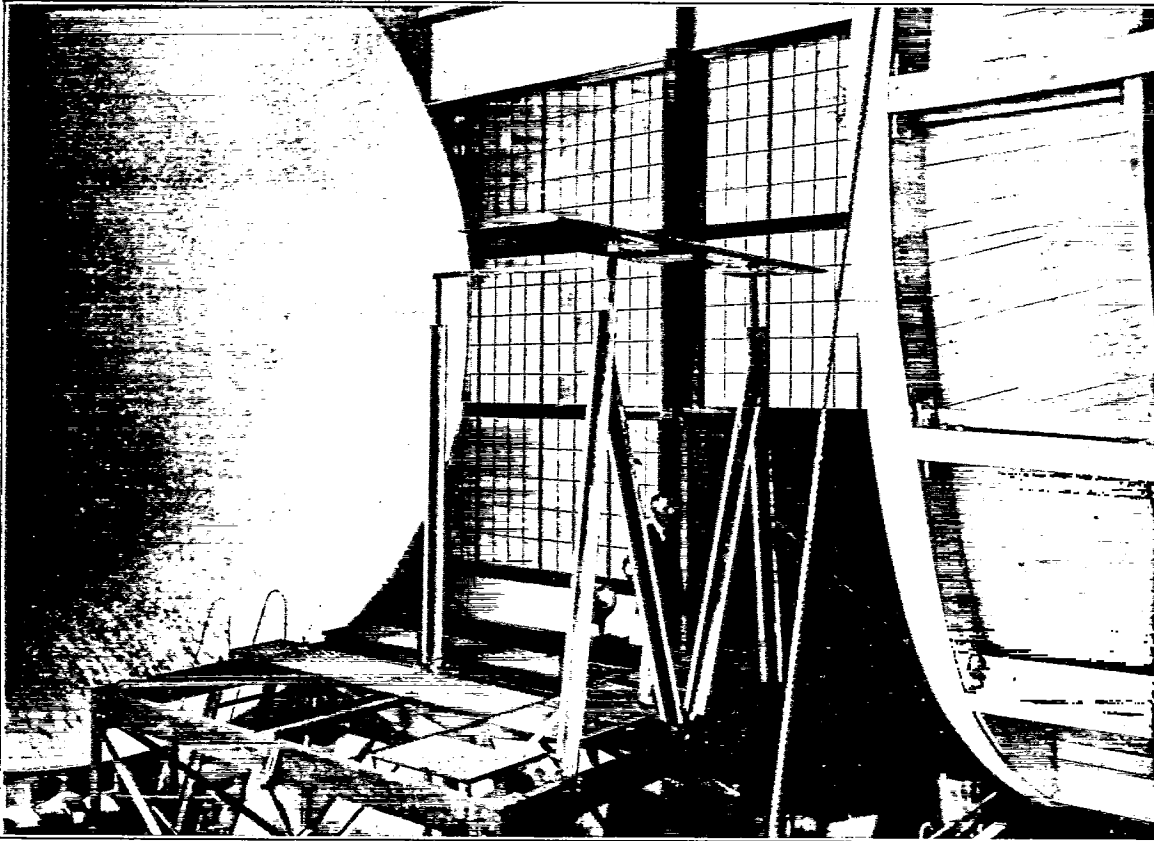

FIG. 16

ACCURACY

Dynamic pressure, thrust, torque, and R. P. M. are measured with an accuracy of from 1 to 2 per cent. Computed data are, therefore, correct to approximately plus or minus 2 per cent and final faired curves through computed points to about plus or minus 1 per cent. This compares favorably with other engineering measurements. The beam thrust balance is to be replaced with a dial scale which will increase the accuracy and will enable the observers to read more quickly and more nearly simultaneously. A change in the linkage of the torque scale is contemplated which will increase the accuracy of that reading. When these changes are in effect it is hoped that computed points will be correct to plus or minus 1 per cent.

CONCLUSION

The propeller research tunnel fulfills a long-felt want in aerodynamic research. Propellers can be tested full scale, and with actual engines and bodies in place, with an accuracy not attained in flight tests. The components of the airplane, fuselage, landing gear, and tail surfaces can be tested full scale. While full size wings can not be accommodated, a stub wing can be installed which is sufficient to study the effects of all parts of the airplane on the propulsive

system, and vice versa. Tests thus far made are consistent and reliable and it is increasingly evident that the propeller research tunnel is a useful addition to the extensive research facilities of the National Advisory Committee for Aeronautics.

LANGLEY MEMORIAL AERONAUTICAL LABORATORY,
NATIONAL ADVISORY COMMITTEE FOR AERONAUTICS,
LANGLEY FIELD, VA., *June 2, 1928.*

REFERENCES

- Reference 1. Weick, Fred E.: Full Scale Drag on Various Parts of Sperry Messenger Airplane. N. A. C. A. Technical Note No. 271, 1928.
- Reference 2. Durand, W. F., and Lesley, E. P.: Comparison of Tests on Air Propellers in Flight with Wind Tunnel Model Tests on Similar Forms. N. A. C. A. Technical Report No. 220, 1926.
- Reference 3. Crowley, J. W., jr., and Mixson, R. E.: Characteristics of Five Propellers in Flight. N. A. C. A. Technical Report No. 292, 1928.
- Reference 4. Glauert, H., and Locke, C. N. H.: On the Advantages of an Open Jet Wind Tunnel for Airscrew Tests. B. A. C. A. R. & M. 1033, 1926.
- Reference 5. Durand, W. F.: Experimental Research on Air Propellers. N. A. C. A. Technical Report No. 14, 1917.