REPORT No. 233

**THE AERODYNAMIC CHARACTERISTICS OF SEVEN
FREQUENTLY USED WING SECTIONS AT
FULL REYNOLDS NUMBER**

By **MAX M. MUNK** and **ELTON W. MILLER**
Langley Memorial Aeronautical Laboratory

REPORT No. 233

THE AERODYNAMIC CHARACTERISTICS OF SEVEN FREQUENTLY USED WING SECTIONS AT FULL REYNOLDS NUMBER

By MAX M. MUNK and ELTON W. MILLER

SUMMARY

This report contains the aerodynamic properties of the wing sections U. S. A. 5, U. S. A. 27, U. S. A. 35 A, U. S. A. 35 B, Clark Y, R. A. F. 15, and Göttingen 387, as determined at various Reynolds Numbers up to an approximately full scale value in the variable density wind tunnel of the National Advisory Committee for Aeronautics.

It is shown that the characteristics of the wings investigated are affected greatly and in a somewhat erratic manner by variation of the Reynolds Number. In general there is a small increase in maximum lift and an appreciable decrease in drag at all lifts.

INTRODUCTION

The tests described in this report were made in the variable density wind tunnel of the National Advisory Committee for Aeronautics. The construction of this tunnel, the features particular to it, and the reasons for providing such features will be the subject of another report.

Since the effective linear model size is equal to the actual model size multiplied by the ratio of the test density to the normal density of air, full scale values of the Reynolds Number are obtained in the variable density wind tunnel with moderate wind speeds on models of ordinary size by compressing the air to about twenty times its normal density (or normal pressure).

The present tests are among the first made in the variable density wind tunnel, and, as might be expected from the newness of the work, there are certain runs and individual readings which do not appear to check with the remaining data. Owing to the general interest in these data and their probable value to airplane designers, it has been decided to make the data immediately available in the present form and to give more complete and more accurate data in some future report or reports. The general effect of the Reynolds Number and the characteristics of the various airfoils at large Reynolds Number are considered to be given with reasonable accuracy by these data.

METHOD OF TEST

The models were smoothly cut of duralumin in rectangular form, 30-inch span and 5-inch chord, with equal and parallel sections along the span. The span of the models, 30-inches, is one-half of the throat diameter of the wind tunnel. In the tests each model was fastened to the tunnel balance by means of thin wires and a vertical shielded bar extending across the tunnel in rear of the model. A skid rigidly connected with the model was hinged to this bar, so that the angle of attack could be changed during the tests by moving the bar up or down.

Each model was investigated through a range of angles of attack at an approximately constant pressure of the air circulating in the wind tunnel. This pressure was increased in steps and each time the test repeated.

In the same way the resistance of the wires and of other auxiliary parts was determined. This latter test includes the slight forces exerted by the air flow on the balances directly, in consequence of small leakages between the test room, the balance room, and the return channel.

The corrections found were applied to the readings obtained with the model at various angles of attack and at various pressures. The velocity of the air flow is approximately the same in all tests, with an average value of about 76 feet per second.

RESULTS OF THE TESTS

The results of the tests are given in the tables and diagrams of this report. Table XXXVI gives the exact shape of the wing sections tested, the ordinates being obtained by measuring the finished model. It is worth mentioning in this connection that in several cases no strict specification of the section exists, as, for instance, several tables of ordinates for the R. A. F. 15 published at different times differ from each other. In such cases the ordinates in general use have been adopted.

Tables I to XXXV give the lift coefficient, drag coefficient, and some of them the moment coefficient for a series of angles of attack, each table for an approximately constant dynamic pressure. The lift coefficient C_L and drag coefficient C_D are obtained by dividing the measured lift L and the corrected drag D by the wing area S and by the dynamic pressure q .

$$C_L = \frac{L}{qS} \text{ and } C_D = \frac{D}{qS}$$

where

$$q = \frac{1}{2} \rho V^2$$

The velocity is always about 76 feet per second. The moment coefficient C_M is obtained from the moment measured with respect to the point on the chord one-quarter chord length from the leading edge, by dividing it by the wing area, by the chord c and by the dynamic pressure q .

$$C_M = \frac{M}{qcS}$$

C_M is positive if it tends to increase the angle of attack; that is, to lift the leading edge up and turn the trailing edge down. The average Reynolds Number for each test is also inserted. The Reynolds Number is computed with reference to the chord as characteristic length of the model.

The results are illustrated by diagrams in the form of the so-called polar curves. There are two diagrams for each section. The one refers to the test at about 20-atmosphere tank pressure, which can be considered as equivalent to a full-size test for an airplane of moderate size. This diagram contains a profile of the section. The lift coefficient is plotted vertically, and against it to the right are plotted the induced drag coefficient (giving a parabola), the observed drag coefficient (giving the polar curve proper), and the negative moment coefficient.

In a second diagram all polar curves of one section observed at different pressures, and hence at different Reynolds Numbers, are drawn side by side. The parabola of induced drag is inserted again.

It appears that the polar curves obtained at different Reynolds Numbers differ appreciably from each other, particularly with the thicker sections. The drag coefficient has generally the tendency to decrease with increase of Reynolds Number, while the lift is not very much affected except in the neighborhood of its maximum.

Table XXXVII has been prepared by Lieut. Walter S. Diehl to supply a condensed summary of the test data in the form commonly used for study of comparative tests. It should be noted that these data are not comparative with tests conducted on other models in other wind tunnels unless appropriate corrections are applied.

CONCLUSIONS

While only conclusions of the most general nature can be safely drawn from these tests, there are certain outstanding features, as follows:

- (1) At any given lift coefficient the drag coefficient has a tendency to decrease as the Reynolds Number is increased.
- (2) The greater the value of minimum drag coefficient at one atmosphere the greater the decrease in minimum drag with increase in Reynolds Number. This is true whether the decrease be taken as an absolute value or as a ratio. In this connection Lieut. Walter S. Diehl points out that the absolute decrease in minimum drag coefficient in passing from 1 to 20 atmospheres for the seven airfoils of this report varies approximately as the cube of the minimum drag coefficient at 1 atmosphere. This relation is probably accidental and is merely cited to show the general nature of the variation.
- (3) Except in the neighborhood of the maximum, the lift coefficient does not appear to be influenced by change in Reynolds Number.
- (4) The maximum lift coefficient is very much affected by change in Reynolds Number. The effect on maximum lift coefficient is quite erratic, and in passing from 1 atmosphere to 20 atmospheres varies from an increase of 14 per cent to a decrease of 23.4 per cent.

Since there is no known reason for doubting that the variations obtained in airfoil characteristics at the higher pressures are a direct effect of the variation in Reynolds Number, it is believed that the aerodynamical properties obtained from tests made in the variable density wind tunnel at full scale values of the Reynolds Number are more reliable and more directly applicable to design than similar data obtained in the ordinary atmospheric wind tunnels at the usual low values of Reynolds Number. This conclusion is supported by the fact that at a pressure of 1 atmosphere the variable density wind tunnel gives results which are in very good agreement with those obtained in the conventional atmospheric wind tunnels.

TABLE I

[Airfoil section U. S. A. 5; model No. 15; span, 30 inches (76.2 centimeters); chord, 5 inches (12.7 centimeters); area, 0.0968 m²; aspect ratio 6]

Angle of attack	Dynamic pressure	Lift coefficient	Drag coefficient
Degrees	q , kg/m ²	C_L	C_D
-6.0	28.1	-0.151	0.0599
-4.5	28.0	.000	.0352
-3.0	28.0	.141	.0204
-1.5	28.0	.254	.0142
0.0	28.0	.354	.0152
1.5	28.1	.439	.0197
3.0	28.1	.537	.0263
4.5	28.1	.634	.0341
6.0	28.1	.808	.0437
9.0	28.0	1.011	.0648
12.0	28.0	1.111	.0945
15.0	28.0	1.111	.1421
18.0	28.0	1.144	.2739
21.0	27.8	1.051	.3650

Average temperature 23° C.; average tank pressure, 1 atmosphere; average Reynolds Number, 179,000.

TABLE II

[Airfoil section, U. S. A. 5; model No. 15; span, 30 inches (76.2 centimeters); chord, 5 inches (12.7 centimeters); area, 0.0968 m²; aspect ratio, 6]

Angle of attack	Dynamic pressure	Lift coefficient	Drag coefficient
Degrees	q , kg/m ²	C_L	C_D
-6.0	76.1	-0.116	0.0573
-4.5	76.1	.011	.0401
-3.0	76.1	.132	.0202
-1.5	75.7	.250	.0140
0.0	76.8	.365	.0147
1.5	76.1	.433	.0200
3.0	75.7	.533	.0263
4.5	75.4	.697	.0333
6.0	75.6	.811	.0424
9.0	76.1	1.007	.0667
12.0	76.1	1.127	.0955
15.0	77.0	1.202	.1402
18.0	76.1	1.165	.2667
21.0	75.4	1.058	.3642

Average temperature, 20° C.; average tank pressure, 2.62 atmospheres; average Reynolds Number, 482,000.

REPORT NATIONAL ADVISORY COMMITTEE FOR AERONAUTICS

TABLE III

[Airfoil section, U. S. A. 5; model No. 15; span, 30 inches (76.2 centimeters); chord, 5 inches (12.7 centimeters); area, 0.0968 m²; aspect ratio, 6]

Angle of attack	Dynamic pressure	Lift coefficient	Drag coefficient
Degrees	q , kg/m ²	C_L	C_D
-6.0	140.0	-0.126	0.0588
-4.5	140.0	-.025	.0402
-3.0	140.0	.133	.0225
-1.5	139.8	.243	.0143
0.0	139.8	.359	.0137
1.5	139.8	.474	.0203
3.0	139.7	.585	.0264
4.5	139.7	.688	.0336
6.0	139.5	.810	.0424
9.0	139.5	1.000	.0668
12.0	139.5	1.134	.0945
15.0	139.5	1.214	.1402
18.0	136.3	1.168	.2623
21.0	137.6	1.065	.3633

Average temperature, 26° C.; average tank pressure, 4.88 atmospheres; average Reynolds Number, 863,000.

TABLE IV

[Airfoil section, U. S. A. 5; model No. 15; span, 30 inches (76.2 centimeters); chord, 5 inches (12.7 centimeters); area, 0.0968 m²; aspect ratio, 6]

Angle of attack	Dynamic pressure	Lift coefficient	Drag coefficient
Degrees	q , kg/m ²	C_L	C_D
-6.0	310	-0.131	0.0589
-4.5	311	-.025	.0406
-3.0	312	.127	.0213
-1.5	312	.234	.0124
0.0	312	.351	.0148
1.5	312	.467	.0193
3.0	313	.582	.0259
4.5	313	.688	.0336
6.0	310	.806	.0418
9.0	310	1.010	.0643
12.0	310	1.159	.0958
15.0	310	1.188	.1381
18.0	307	1.151	.2440
21.0	300	1.092	.3580

Average temperature, 33° C.; average tank pressure, 10.48 atmospheres; average Reynolds Number, 1,840,000.

TABLE V

[Airfoil section, U. S. A. 5; model No. 15; span, 30 inches (76.2 centimeters); chord, 5 inches (12.7 centimeters); area, 0.0968 m²; aspect ratio, 6]

Angle of attack	Dynamic pressure	Lift coefficient	Drag coefficient	Moment coefficient ¹
Degrees	q , kg/m ²	C_L	C_D	C_M
-6.0	633	-0.133	0.0586	-0.071
-4.5	635	-.030	.0388	-.012
-3.0	639	.101	.0142	-.059
-1.5	645	.237	.0115	-.093
0.0	640	.324	.0144	-.094
1.5	639	.441	.0180	-.092
3.0	634	.562	.0244	-.095
4.5	643	.662	.0310	-.110
6.0	643	.782	.0400	-.098
9.0	642	1.001	.0629	-.080
12.0	641	1.188	.0918	-.078
15.0	640	1.184	.1250	-.122
18.0	626	1.134	.2163	-.121
21.0	621	1.080	.3173	-.154

¹ Moments taken about a point at 25 per cent of the chord.

Average temperature, 35° C.; average tank pressure, 20.07 atmospheres; average Reynolds Number, 3,630,000.

TABLE VI

[Airfoil section, U. S. A. 27; model No. 16; span, 30 inches (76.2 centimeters); chord, 5 inches (12.7 centimeters); area, 0.0968 m²; aspect ratio, 6]

Angle of attack	Dynamic pressure	Lift coefficient	Drag coefficient
Degrees	q , kg/m ²	C_L	C_D
-6.0	27.1	-0.046	0.0484
-4.5	27.1	.072	.0276
-3.0	27.1	.190	.0177
-1.5	27.1	.282	.0188
0.0	27.1	.392	.0194
1.5	26.8	.494	.0247
3.0	26.8	.628	.0297
4.5	27.2	.728	.0396
6.0	27.2	.830	.0471
9.0	27.2	1.015	.0688
12.0	27.2	1.193	.0947
15.0	27.2	1.304	.1228
18.0	27.1	1.270	.1891
21.0	26.9	1.142	.2552

Average temperature, 23° C.; average tank pressure, 1 atmosphere; average Reynolds Number, 175,000.

TABLE VII

[Airfoil section, U. S. A-27; model No. 16; span, 30 inches (76.2 centimeters); chord, 5 inches (12.7 centimeters); area, 0.0968 m²; aspect ratio, 6]

Angle of attack	Dynamic pressure	Lift coefficient	Drag coefficient
Degrees	q , kg/m ²	C_L	C_D
-6.0	73.3	-0.041	0.0469
-4.5	73.3	.062	.0265
-3.0	73.6	.168	.0171
-1.5	73.6	.260	.0149
0.0	73.6	.367	.0176
1.5	73.6	.474	.0218
3.0	72.5	.579	.0269
4.5	72.5	.678	.0330
6.0	72.5	.788	.0417
9.0	72.5	.989	.0649
12.0	72.5	1.165	.0869
15.0	72.5	1.214	.1304
18.0	71.8	1.167	.1915
21.0	71.8	1.154	.2410

Average temperature, 26° C.; average tank pressure, 2.58 atmospheres; average Reynolds Number, 456,000.

TABLE VIII

[Airfoil section, U. S. A. 27; model No. 16; span, 30 inches (76.2 centimeters); chord, 5 inches (12.7 centimeters); area, 0.0968 m²; aspect ratio, 6]

Angle of attack	Dynamic pressure	Lift coefficient	Drag coefficient
Degrees	q , kg/m ²	C_L	C_D
-6.0	148	-0.058	0.0441
-4.5	148	.045	.0253
-3.0	148	.153	.0144
-1.5	148	.248	.0131
0.0	148	.361	.0159
1.5	148	.470	.0203
3.0	148	.578	.0251
4.5	148	.686	.0322
6.0	148	.795	.0408
9.0	148	.999	.0606
12.0	148	1.163	.0852
15.0	148	1.206	.1293
18.0	146	1.168	.1991
21.0	146	1.076	.2529

Average temperature, 29° C.; average tank pressure, 5.10 atmospheres; average Reynolds Number, 900,000.

TABLE IX

[Airfoil section, U. S. A. 27; model No. 16; span, 30 inches (76.2 centimeters); chord, 5 inches (12.7 centimeters); area, 0.0968 m²; aspect ratio, 6]

Angle of attack	Dynamic pressure	Lift coefficient	Drag coefficient
Degrees	<i>q</i> , kg/m ²	<i>C_L</i>	<i>C_D</i>
-6.0	318	-0.044	0.0307
-4.5	318	.031	.0170
-3.0	318	.131	.0119
-1.5	318	.234	.0130
0.0	318	.345	.0160
1.5	318	.455	.0203
3.0	320	.560	.0259
4.5	320	.659	.0328
6.0	320	.771	.0407
9.0	320	.966	.0602
12.0	319	1.148	.0857
15.0	316	1.290	.1160
18.0	316	1.246	.1348
21.0	313	1.140	.2533

Average temperature, 25° C.; average tank pressure, 10.14 atmospheres; average Reynolds Number, 1,890,000.

TABLE X

[Airfoil section, U. S. A. 27; model No., 16; span, 30 inches (76.2 centimeters); chord, 5 inches (12.7 centimeters); area, 0.0968 m²; aspect ratio, 6]

Angle of attack	Dynamic pressure	Lift coefficient	Drag coefficient	Moment coefficient ¹
Degrees	<i>q</i> , kg/m ²	<i>C_L</i>	<i>C_D</i>	<i>C_M</i>
-6.0	624	-0.100	0.0127	-0.088
-4.5	626	.007	.0117	-.088
-3.0	626	.120	.0117	-.082
-1.5	625	.221	.0131	-.082
0.0	626	.332	.0160	-.081
1.5	626	.439	.0198	-.073
3.0	627	.553	.0255	-.061
4.5	628	.654	.0325	-.074
6.0	627	.768	.0417	-.064
9.0	626	.972	.0616	-.064
12.0	629	1.165	.0863	-.052
15.0	629	1.326	.1169	-.056
16.0	625	1.386	.129	-.161
18.0	627	1.324	.1815	-.154
21.0	613	1.181	.262	-.192

¹ Moments taken about a point at 25 per cent of the chord.

Average temperature, 34° C.; average tank pressure 19.92 atmospheres; average Reynolds Number, 3,570,000.

TABLE XI

[Airfoil section U. S. A. 35 A; model No., 17; span, 30 inches (76.2 centimeters); chord, 5 inches (12.7 centimeters); area, 0.0968 m²; aspect ratio, 6]

Angle of attack	Dynamic pressure	Lift coefficient	Drag coefficient
Degrees	<i>q</i> , kg/m ²	<i>C_L</i>	<i>C_D</i>
-9.0	28.2	0.019	0.0776
-6.0	28.1	.197	.0227
-4.5	27.9	.300	.0230
-3.0	27.9	.410	.0249
-1.5	27.9	.510	.0281
0.0	27.9	.640	.0359
1.5	27.9	.740	.0428
3.0	27.9	.860	.0519
4.5	27.9	.980	.0615
6.0	27.9	1.070	.0740
9.0	27.9	1.263	.0990
12.0	27.9	1.410	.1280
15.0	27.9	1.520	.1630
18.0	27.9	1.570	.2110
21.0	27.9	1.570	.2610

Average temperature 20° C.; average tank pressure, 1 atmosphere; average Reynolds Number, 180,000

TABLE XII

[Airfoil section, U. S. A. 35 A; model No., 17; span, 30 inches (76.2 centimeters); chord, 5 inches (12.7 centimeters); area, 0.0968 m²; aspect ratio, 6]

Angle of attack	Dynamic pressure	Lift coefficient	Drag coefficient
Degrees	<i>q</i> , kg/m ²	<i>C_L</i>	<i>C_D</i>
-9.0	72.4	0.003	0.0612
-6.0	72.6	.200	.0190
-4.5	72.9	.298	.0202
-3.0	72.5	.408	.0234
-1.5	71.8	.515	.0281
0.0	71.8	.629	.0337
1.5	71.8	.739	.0414
3.0	71.8	.844	.0491
4.5	71.8	.945	.0600
6.0	71.8	1.047	.0701
9.0	71.8	1.213	.0950
12.0	71.3	1.359	.1253
15.0	71.3	1.445	.1670
18.0	71.3	1.486	.3620
21.0	71.1	1.480	.4110

Average temperature, 22° C.; average tank pressure, 2.43 atmospheres; average Reynolds Number, 450,000.

TABLE XIII

[Airfoil section, U. S. A. 35 A; model No., 17; span, 30 inches (76.2 centimeters); chord, 5 inches (12.7 centimeters); area, 0.0968 m²; aspect ratio, 6]

Angle of attack	Dynamic pressure	Lift coefficient	Drag coefficient
Degrees	<i>q</i> , kg/m ²	<i>C_L</i>	<i>C_D</i>
-9.0	156.3	-0.045	0.0150
-6.0	156.3	.186	.0149
-4.5	156.3	.290	.0171
-3.0	157.1	.409	.0215
-1.5	158.0	.513	.0258
0.0	158.0	.626	.0319
1.5	155.5	.731	.0401
3.0	155.5	.838	.0479
4.5	155.5	.936	.0581
6.0	155.5	1.041	.0696
9.0	155.5	1.215	.0953
12.0	153.3	1.363	.1303
15.0	155.0	1.412	.1721
18.0	155.0	1.434	.2320
21.0	154.0	1.424	.2790

Average temperature, 25° C.; average tank pressure, 5.37 atmospheres; average Reynolds Number, 960,000.

TABLE XIV

[Airfoil section, U. S. A. 35 A; model No., 17; span, 30 inches (76.2 centimeters); chord, 5 inches (12.7 centimeters); area, 0.0968 m²; aspect ratio, 6]

Angle of attack	Dynamic pressure	Lift coefficient	Drag coefficient
Degrees	<i>q</i> , kg/m ²	<i>C_L</i>	<i>C_D</i>
-9.0	317	-0.058	0.0181
-6.0	315	.173	.0150
-4.5	318	.269	.0163
-3.0	319	.387	.0203
-1.5	311	.491	.0247
0.0	313	.602	.0313
1.5	313	.709	.0391
3.0	310	.806	.0460
4.5	310	.901	.0565
6.0	309	.989	.0676
9.0	304	1.162	.1042
12.0	304	1.225	.1480
15.0	310	1.240	.1848
18.0	309	1.205	.2400
21.0	304	1.131	.2847

Average temperature, 27° C.; average tank pressure, 10.25 atmospheres; average Reynolds Number, 1,860,000.

TABLE XV

[Airfoil section, U. S. A. 35 A; model No., 17; span, 30 inches (76.2 centimeters); chord, 5 inches (12.7 centimeters); area, 0.0968 m²; aspect ratio, 6]

Angle of attack	Dynamic pressure	Lift coefficient	Drag coefficient	Moment coefficient ¹
Degrees	$q, \text{ kg/m}^2$	C_L	C_D	C_M
-9.0	629	-0.075	0.0168	-0.117
-6.0	637	.146	.0142	-.118
-4.5	636	.252	.0162	-.116
-3.0	632	.365	.0196	-.112
-1.5	630	.468	.0240	-.107
0.0	612	.556	.0304	-.108
1.5	617	.692	.0378	-.107
3.0	617	.798	.0468	-.104
4.5	631	.884	.0564	-.101
6.0	631	.984	.0677	-.110
9.0	630	1.142	.0956	-.105
12.0	627	1.203	.1399	-.127
15.0	615	1.201	.1934	-.142
18.0	617	1.152	.2424	-.150
21.0	616	1.097	.2877	-.123

¹ Moments taken about a point at 25 per cent of the chord.

Average temperature, 40° C.; average tank pressure, 20.3 atmospheres; average Reynolds Number, 3,520,000.

TABLE XVI

[Airfoil section, U. S. A. 35 B; model No., 18; span, 30 inches (76.2 centimeters); chord, 5 inches (12.7 centimeters); area, 0.0968 m²; aspect ratio, 6]

Angle of attack	Dynamic pressure	Lift coefficient	Drag coefficient
Degrees	$q, \text{ kg/m}^2$	C_L	C_D
-9.0	24.9	-0.257	0.1096
-6.0	25.0	-.021	.0260
-4.5	25.2	.082	.0214
-3.0	25.2	.185	.0207
-1.5	25.2	.291	.0227
0.0	25.2	.401	.0264
1.5	25.2	.520	.0314
3.0	25.2	.640	.0395
4.5	25.2	.753	.0473
6.0	25.2	.865	.0539
9.0	25.2	1.060	.0847
12.0	25.2	1.218	.1125
15.0	25.2	1.245	.1525
18.0	25.0	1.150	.2566
21.0	25.0	.930	.3572

Average temperature, 32° C.; average tank pressure, 1 atmosphere; average Reynolds Number, 163,000.

TABLE XVII

[Airfoil section, U. S. A. 35 B; model No., 18; span, 30 inches (76.2 centimeters); chord, 5 inches (12.7 centimeters); area, 0.0968 m²; aspect ratio, 6]

Angle of attack	Dynamic pressure	Lift coefficient	Drag coefficient
Degrees	$q, \text{ kg/m}^2$	C_L	C_D
-9.0	65.6	-0.245	0.0675
-6.0	65.6	-.033	.0148
-4.5	65.6	.073	.0141
-3.0	65.6	.186	.0149
-1.5	65.7	.292	.0185
0.0	65.5	.410	.0215
1.5	65.0	.526	.0279
3.0	65.5	.627	.0332
4.5	65.0	.736	.0431
6.0	65.0	.852	.0535
9.0	65.5	1.053	.0794
12.0	65.5	1.211	.1077
15.0	64.3	1.253	.1561
18.0	64.3	1.212	.2151
21.0	64.3	1.083	.3187

Average temperature, 28° C.; average tank pressure, 2.45 atmospheres; average Reynolds Number, 415,000.

TABLE XVIII

[Airfoil section, U. S. A. 35 B; model No., 18; span, 30 inches (76.2 centimeters); chord, 5 inches (12.7 centimeters); area, 0.0968 m²; aspect ratio, 6]

Angle of attack	Dynamic pressure	Lift coefficient	Drag coefficient
Degrees	$q, \text{ kg/m}^2$	C_L	C_D
-9.0	146.4	-0.250	0.0659
-6.0	145.6	-.036	.0111
-4.5	145.6	.069	.0115
-3.0	145.4	.180	.0123
-1.5	145.4	.288	.0150
0.0	145.4	.408	.0204
1.5	144.5	.524	.0264
3.0	144.3	.690	.0336
6.0	146.0	.852	.0529
9.0	146.0	1.054	.0782
12.0	146.0	1.221	.1060
15.0	146.0	1.301	.1518
18.0	146.0	1.232	.2210
21.0	144.2	1.196	.2827

Average temperature, 41° C.; average tank pressure, 5.24 atmospheres; average Reynolds Number, 859,000.

TABLE XIX

[Airfoil section, U. S. A. 35 B; model No., 18; span, 30 inches (76.2 centimeters); chord, 5 inches (12.7 centimeters); area, 0.0968 m²; aspect ratio, 6]

Angle of attack	Dynamic pressure	Lift coefficient	Drag coefficient
Degrees	$q, \text{ kg/m}^2$	C_L	C_D
-9.0	289	-0.278	0.0168
-6.0	290	-.083	.0103
-4.5	290	.054	.0101
-3.0	290	.169	.0125
-1.5	290	.280	.0144
0.0	290	.397	.0191
1.5	290	.510	.0256
3.0	290	.625	.0335
6.0	290	.845	.0504
9.0	289	1.050	.0760
12.0	289	1.240	.1049
15.0	289	1.370	.1411
18.0	289	1.327	.2144
21.0	289	1.167	.2805

Average temperature, 40° C.; average tank pressure, 10.2 atmospheres; average Reynolds Number, 1,695,000.

TABLE XX

[Airfoil section, U. S. A. 35 B; model No., 18; span, 30 inches (76.2 centimeters); chord, 5 inches (12.7 centimeters); area, 0.0968 m²; aspect ratio, 6]

Angle of attack	Dynamic pressure	Lift coefficient	Drag coefficient	Moment coefficient ¹
Degrees	$q, \text{ kg/m}^2$	C_L	C_D	C_M
-9.0	620	-0.235	0.0168	-0.072
-6.0	628	-.062	.0094	-.074
-4.5	623	.044	.0093	-.071
-3.0	623	.157	.0107	-.070
-1.5	618	.263	.0138	-.070
0.0	624	.378	.0174	-.052
1.5	624	.488	.0231	-.054
3.0	624	.603	.0308	-.081
6.0	623	.823	.0497	-.054
9.0	622	1.045	.0746	-.059
12.0	621	1.235	.1030	-.064
15.0	621	1.374	.1365	-.099
18.0	617	1.304	.2149	-.096
21.0	616	1.181	.2965	-.152

¹ Moments taken about a point at 25 per cent of the chord.

Average temperature, 40° C.; average tank pressure, 19.82 atmospheres; average Reynolds Number, 3,470,000.

TABLE XXI

[Airfoil section, Clark Y; model No., 14; span, 30 inches (76.2 centimeters); chord, 5 inches (12.7 centimeters); area, 0.0968 m²; aspect ratio, 6]

Angle of attack	Dynamic pressure	Lift coefficient	Drag coefficient
Degrees	<i>q</i> , kg/m ²	<i>C_L</i>	<i>C_D</i>
-6.0	28.1	-0.007	0.0150
-4.5	28.1	.006	.0127
-3.0	28.1	.010	.0131
-1.5	28.1	.036	.0141
0.0	28.1	.421	.0168
1.5	28.1	.545	.0223
3.0	28.1	.637	.0293
4.5	28.1	.744	.0372
6.0	28.1	.858	.0478
9.0	28.4	1.060	.0703
12.0	28.4	1.199	.0940
15.0	28.4	1.208	.1420
18.0	28.4	1.133	.2359
21.0	27.9	.908	.3629

Average temperature, 16° C.; average tank pressure, 1 atmosphere; average Reynolds Number, 181,000.

TABLE XXII

[Airfoil section, Clark Y; model No., 14; span, 30 inches (76.2 centimeters); chord, 5 inches (12.7 centimeters); area, 0.0968 m²; aspect ratio, 6]

Angle of attack	Dynamic pressure	Lift coefficient	Drag coefficient
Degrees	<i>q</i> , kg/m ²	<i>C_L</i>	<i>C_D</i>
-6.0	72.2	-0.029	0.0114
-4.5	72.2	.080	.0105
-3.0	72.0	.193	.0113
-1.5	71.1	.299	.0145
0.0	72.2	.417	.0176
1.5	72.2	.516	.0225
3.0	71.2	.618	.0275
4.5	72.0	.725	.0369
6.0	72.0	.836	.0570
9.0	72.0	1.037	.0795
12.0	72.0	1.168	.1072
15.0	71.2	1.182	.1476
18.0	71.2	1.118	.2124
21.0	71.2	.970	.2545

Average temperature, 19.5° C.; average tank pressure, 2.52 atmospheres; average Reynolds Number, 460,000.

TABLE XXIII

[Airfoil section, Clark Y; model No., 14; span, 30 inches (76.2 centimeters); chord, 5 inches (12.7 centimeters); area, 0.0968 m²; aspect ratio, 6]

Angle of attack	Dynamic pressure	Lift coefficient	Drag coefficient
Degrees	<i>q</i> , kg/m ²	<i>C_L</i>	<i>C_D</i>
-6.0	156	-0.040	0.0102
-4.5	157	.073	.0097
-3.0	155	.179	.0108
-1.5	155	.293	.0131
0.0	155	.403	.0169
1.5	155	.510	.0220
3.0	155	.620	.0290
4.5	154	.725	.0370
6.0	154	.839	.0471
9.0	154	1.025	.0693
12.0	153	1.184	.0966
15.0	153	1.188	.1461
18.0	152	1.126	.2251
21.0	152	1.042	.3045

Average temperature, 27° C.; average tank pressure, 5.44 atmospheres; average Reynolds Number, 965,000.

TABLE XXIV

[Airfoil section, Clark Y; model No., 14; span, 30 inches (76.2 centimeters); chord, 5 inches (12.7 centimeters); area, 0.0968 m²; aspect ratio, 6]

Angle of attack	Dynamic pressure	Lift coefficient	Drag coefficient
Degrees	<i>q</i> , kg/m ²	<i>C_L</i>	<i>C_D</i>
-6.0	311	-0.045	0.0118
-4.5	311	.067	.0112
-3.0	312	.176	.0121
-1.5	312	.287	.0145
0.0	308	.401	.0183
1.5	305	.504	.0235
3.0	302	.616	.0288
4.5	305	.721	.0384
6.0	304	.832	.0461
9.0	304	1.025	.0691
12.0	304	1.213	.0976
15.0	304	1.318	.1295
18.0	303	1.254	.2100
21.0	301	1.070	.2857

Average temperature, 28° C.; average tank pressure, 10.2 atmospheres; average Reynolds Number, 1,850,000.

TABLE XXV

[Airfoil section, Clark Y; model No., 14; span, 30 inches (76.2 centimeters); chord, 5 inches (12.7 centimeters); area, 0.0968 m²; aspect ratio, 6]

Angle of attack	Dynamic pressure	Lift coefficient	Drag coefficient	Moment coefficient ¹
Degrees	<i>q</i> , kg/m ²	<i>C_L</i>	<i>C_D</i>	<i>C_M</i>
-6.0	631	-0.060	0.0108	-0.083
-4.5	629	.045	.0107	-.080
-3.0	637	.167	.0119	-.073
-1.5	635	.268	.0139	-.073
0.0	637	.384	.0172	-.070
1.5	629	.501	.0228	-.059
3.0	634	.602	.0288	-.073
6.0	632	.819	.0464	-.079
9.0	631	1.034	.0700	-.054
12.0	630	1.231	.0935	-.036
15.0	630	1.367	.1272	-.077
18.0	623	1.283	.2108	-.056
21.0	616	1.081	.2946	-.048

¹ Moments taken about a point at 25 per cent of the chord.

Average temperature, 36° C.; average tank pressure, 20.4 atmospheres; average Reynolds Number, 3,610,000.

TABLE XXVI

[Airfoil section, R. A. F. 15; model No., 19; span, 30 inches (76.2 centimeters); chord, 5 inches (12.7 centimeters); area, 0.0968 m²; aspect ratio, 6]

Angle of attack	Dynamic pressure	Lift coefficient	Drag coefficient
Degrees	<i>q</i> , kg/m ²	<i>C_L</i>	<i>C_D</i>
-3.0	28.6	-0.076	0.0129
-1.5	28.7	.054	.0102
0.0	28.7	.187	.0107
1.5	28.4	.298	.0123
3.0	28.6	.404	.0170
4.5	28.6	.512	.0220
6.0	28.4	.626	.0302
9.0	28.6	.838	.0490
12.0	28.6	1.022	.0738
15.0	28.6	1.066	.1391
18.0	28.6	1.018	.2706
21.0	28.4	.895	.3338

Average temperature 17° C.; average tank pressure 1 atmosphere; average Reynolds Number, 185,000

TABLE XXVII

[Airfoil section, R. A. F. 15; model No. 19; span, 30 inches (76.2 centimeters); chord, 5 inches (12.7 centimeters); area, 0.0968 m²; aspect ratio, 6]

Angle of attack	Dynamic pressure	Lift coefficient	Drag coefficient
Degrees	q , kg/m ²	C_L	C_D
-3.0	73.3	-0.042	0.0107
-1.5	73.2	.068	.0093
0.0	73.2	.179	.0102
1.5	72.8	.289	.0128
3.0	72.8	.402	.0164
4.5	72.8	.513	.0217
6.0	72.8	.642	.0285
9.0	72.8	.849	.0468
12.0	72.8	1.031	.0735
15.0	73.4	1.059	.1498
18.0	72.0	1.020	.2672
21.0	72.0	.922	.3398

Average temperature, 18° C.; average tank pressure, 2.51 atmospheres; average Reynolds Number 461,000.

TABLE XXVIII

[Airfoil section, R. A. F. 15; model No., 19; span, 30 inches (76.2 centimeters); chord, 5 inches (12.7 centimeters); area, 0.0968 m²; aspect ratio, 6]

Angle of attack	Dynamic pressure	Lift coefficient	Drag coefficient
Degrees	q , kg/m ²	C_L	C_D
-3.0	153.0	-0.042	0.0100
-1.5	153.0	.061	.0097
0.0	153.0	.179	.0112
1.5	153.0	.292	.0127
3.0	153.0	.404	.0162
4.5	153.0	.512	.0218
6.0	152.8	.628	.0296
9.0	152.8	.841	.0469
12.0	152.8	1.050	.0726
15.0	150.2	1.048	.1376
18.0	151.0	.955	.2400
21.0	150.2	.944	.3288

Average temperature, 21° C.; average tank pressure, 5.1 atmospheres; average Reynolds Number, 950,000.

TABLE XXIX

[Airfoil section, R. A. F. 15; model No., 19; span, 30 inches (76.2 centimeters); chord, 5 inches (12.7 centimeters); area, 0.0968 m²; aspect ratio, 6]

Angle of attack	Dynamic pressure	Lift coefficient	Drag coefficient
Degrees	q , kg/m ²	C_L	C_D
-4.5	337	-0.152	0.0207
-3.0	338	-.046	.0110
-1.5	340	.055	.0099
0.0	340	.172	.0109
1.5	338	.290	.0134
3.0	342	.401	.0183
4.5	333	.512	.0225
6.0	233	.624	.0300
9.0	334	.845	.0486
12.0	337	1.047	.0720
15.0	332	1.095	.1389
18.0	332	1.061	.1659
18.0	332	.981	.2208
21.0	329	.959	.3238

Average temperature, 21° C.; average tank pressure, 10.75 atmospheres; average Reynolds Number, 2,000,000.

TABLE XXX

[Airfoil section, R. A. F. 15; model No., 19; span 30 inches (76.2 centimeters); chord, 5 inches (12.7 centimeters); area, 0.0968 m²; aspect ratio, 6]

Angle of attack	Dynamic pressure	Lift coefficient	Drag coefficient	Moment coefficient ¹
Degrees	q , kg/m ²	C_L	C_D	C_M
-4.5	633	-0.162	0.0139	-0.054
-3.0	634	-.052	.0087	-.052
-1.5	634	.052	.0083	-.053
0.0	634	.166	.0088	-.048
1.5	633	.285	.0119	-.045
3.0	632	.398	.0154	-.044
4.5	637	.507	.0205	-.049
6.0	636	.629	.0280	-.045
9.0	630	.850	.0477	-.048
12.0	635	1.068	.0734	-.049
15.0	634	1.209	.0997	-.046
18.0	617	1.004	.2131	-.138
21.0	613	.924	.2872	-.137
16±	615	1.127	.1527	-.077

¹ Moments taken about a point at 25 per cent of the chord.

Average temperature, 36° C.; average tank pressure, 20 atmospheres; average Reynolds Number 3,580,000.

TABLE XXXI

[Airfoil section, Göttingen 387; model No., 20; span, 30 inches (76.2 centimeters); chord, 5 inches (12.7 centimeters); area, 0.0968 m²; aspect ratio, 6]

Angle of attack	Dynamic pressure	Lift coefficient	Drag coefficient
Degrees	q , kg/m ²	C_L	C_D
-9.0	26.0	-0.115	0.0770
-6.0	25.4	.114	.0276
-4.5	26.1	.194	.0252
-3.0	26.4	.293	.0272
-1.5	26.4	.402	.0300
0.0	26.1	.542	.0358
1.5	26.1	.650	.0426
3.0	26.1	.761	.0506
4.5	26.1	.860	.0618
6.0	26.1	.971	.0728
9.0	26.1	1.156	.1012
12.0	26.4	1.298	.1352
15.0	26.4	1.396	.1720
18.0	26.4	1.420	.2190
21.0	26.4	1.392	.2730

Average temperature, 22° C.; average tank pressure, 1 atmosphere; average Reynolds Number, 173,000.

TABLE XXXII

[Airfoil section, Göttingen 387; model No., 20; span, 30 inches (76.2 centimeters); chord, 5 inches (12.7 centimeters); area, 0.0968 m²; aspect ratio, 6]

Angle of attack	Dynamic pressure	Lift coefficient	Drag coefficient
Degrees	q , kg/m ²	C_L	C_D
-9.0	68.6	-0.113	0.0657
-6.0	68.0	.090	.0188
-4.5	68.0	.191	.0199
-3.0	68.0	.302	.0211
-1.5	68.0	.412	.0259
0.0	68.0	.530	.0315
1.5	68.0	.642	.0391
3.0	68.0	.748	.0473
6.0	68.0	.961	.0697
9.0	68.1	1.152	.0963
12.0	68.5	1.302	.1269
15.0	67.0	1.383	.1738
18.0	68.2	1.380	.2248
21.0	67.0	1.327	.2860

Average temperature, 23° C.; average tank pressure, 2.52 atmospheres; average Reynolds Number, 440,000.

TABLE XXXIII

[Airfoil section, model No., 20; span, 30 inches (76.2 centimeters); chord, 5 inches (12.7 centimeters); aspect ratio, 6]

Angle of attack	Dynamic pressure	Lift coefficient	Drag coefficient
Degrees	q , kg/m ²	C_L	C_D
-9.0	152.0	-0.137	0.0172
-6.0	151.7	.087	.0141
-4.5	151.7	.192	.0141
-3.0	151.5	.314	.0174
-1.5	151.5	.415	.0217
0.0	151.3	.533	.0234
1.5	151.3	.650	.0366
3.0	151.3	.754	.0443
6.0	151.1	.972	.0668
9.0	152.0	1.160	.0924
12.0	152.0	1.320	.1243
15.0	152.0	1.370	.1729
18.0	151.0	1.375	.2309
21.0	150.2	1.296	.2835

Average temperature, 30° C.; average tank pressure, 5.37 atmospheres; average Reynolds Number, 940,000.

TABLE XXXIV

[Airfoil section, No. 20, span, 30 inches (76.2 centimeters); chord, 5 inches (12.7 centimeters); aspect ratio, 6]

Angle of attack	Dynamic pressure	Lift coefficient	Drag coefficient
Degrees	q , kg/m ²	C_L	C_D
-9.0	306	-0.148	0.0161
-6.0	305	.083	.0130
-4.5	305	.195	.0142
-3.0	306	.308	.0170
-1.5	306	.407	.0219
0.0	306	.524	.0289
1.5	305	.635	.0339
3.0	304	.746	.0455
6.0	305	.953	.0640
9.0	304	1.143	.0916
12.0	304	1.281	.1263
15.0	301	1.309	.1771
18.0	304	1.310	.2336
21.0	302	1.283	.2838

Average temperature, 28° C.; average tank pressure, 10.2 atmospheres; average Reynolds Number, 1,520,000.

TABLE XXXV

[Airfoil section, model No., 20; span, 30 inches (76.2 centimeters); chord, 5 inches (12.7 centimeters); aspect ratio, 6]

Angle of attack	Dynamic pressure	Lift coefficient	Drag coefficient	Moment coefficient ¹
Degrees	q , kg/m ²	C_L	C_D	C_M
-9.0	623	-0.156	0.0154	-0.097
-6.0	623	.061	.0126	-.091
-4.5	622	.168	.0137	-.093
-3.0	622	.280	.0167	-.098
-1.5	617	.390	.0260	-.079
0.0	618	.504	.0266	-.076
1.5	620	.612	.0343	-.080
3.0	622	.725	.0433	-.073
6.0	621	.960	.0651	-.044
9.0	620	1.146	.0917	-.062
12.0	618	1.308	.1227	-.067
15.0	616	1.328	.1731	-.109
18.0	617	1.320	.2347	-.116
21.0	615	1.276	.2894	-.129

¹ Moments taken about a point at 25 per cent of the chord.

Average temperature, 39° C.; average tank pressure, 19.8 atmospheres; average Reynolds Number, 3,470,000.

TABLE XXXVI

Per cent of chord	Section R. A. F. 15		Section U. S. A. 5		Section U. S. A. 27		Section Göttingen 387	
	Upper	Lower	Upper	Lower	Upper	Lower	Upper	Lower
0	0.20	0.20	0.73	0.33	1.77	1.77	3.61	3.61
1.25	1.90	-0.45	2.10	0.17	3.80	0.50	6.74	1.35
2.5	2.75	-0.71	3.04	0.03	5.07	0.36	7.96	0.80
5	3.93	-0.94	4.42	0.03	6.94	0.19	9.85	0.36
7.5	4.55	-1.00	5.41	0.25	8.22	0.10	11.32	0.18
10	5.06	-1.00	6.22	0.60	9.19	0.02	12.37	0.08
15	5.58	-0.80	7.20	1.15	10.50	0.10	13.83	0.00
20	5.77	-0.50	7.94	1.59	11.37	0.36	14.77	0.06
30	5.85	-0.04	8.38	2.00	11.97	0.93	15.88	0.20
40	5.68	-0.03	8.17	2.16	11.68	1.14	14.91	0.35
50	5.34	-0.22	7.66	1.94	10.86	0.75	13.41	0.47
60	4.78	-0.46	6.76	1.62	9.54	0.28	11.56	0.56
70	4.10	-0.69	5.62	1.16	8.08	0.06	9.18	0.50
80	3.30	-0.59	4.20	0.77	6.10	0.01	6.57	0.45
90	2.26	-0.32	2.48	0.40	3.69	0.12	3.59	0.25
95	1.63	-0.18	1.50	0.20	2.26	0.33	1.99	0.16
100	0.30	+0.30	0.50	0.00	0.67	0.65	0.37	0.00

Ordinates of upper and lower boundary of sections at different stations of the chord.

Per cent of chord	Section U. S. A. 35 B		Section U. S. A. 35 A		Section Clark Y	
	Upper	Lower	Upper	Lower	Upper	Lower
0	2.76	2.76	4.33	4.33	3.58	3.62
1.25	5.15	1.03	8.09	1.62	5.38	1.86
2.5	6.11	0.63	9.54	1.00	6.43	1.42
5	7.52	0.28	11.81	0.46	7.83	0.91
7.5	8.65	0.14	13.58	0.22	8.79	0.53
10	9.45	0.07	14.85	0.10	9.56	0.39
15	10.56	0.00	16.60	0.00	10.63	0.12
20	11.28	0.05	17.73	0.08	11.32	0.01
30	11.76	0.15	18.46	0.24	11.68	0.00
40	11.42	0.28	17.89	0.40	11.37	0.00
50	10.33	0.39	16.21	0.58	10.49	0.00
60	8.81	0.45	13.83	0.66	9.13	0.00
70	7.03	0.42	11.11	0.60	7.34	0.00
80	5.02	0.35	7.88	0.50	5.21	0.00
90	2.72	0.20	4.31	0.32	2.79	0.00
95	1.50	0.12	2.39	0.19	1.50	0.00
100	0.25	0.00	0.43	0.00	0.12	0.00

TABLE XXXVII

SUMMARY OF TEST DATA FOR COMPARISON

Airfoil section	Tank pressure atmospheres	Reynolds Number	Maximum lift C_L max.	Minimum drag C_D min.	Ratio C_L max. / C_D min.	Maximum ratio L/D	Maximum ratio $(C_L/C_D)^2$
U. S. A. 5	1.00	170,000	1.150	0.0140	82.1	25.0	7,760
	2.62	482,000	1.205	.0138	87.0	25.0	9,187
	4.86	863,000	1.220	.0139	87.8	23.6	9,398
	10.48	1,840,000	1.195	.0123	97.2	24.3	11,280
U. S. A. 27	20.07	3,630,000	1.200	.0113	106.2	24.7	13,533
	1.00	175,000	1.310	.0160	81.8	20.6	8,782
	2.58	456,000	1.215	.0149	81.3	21.8	8,078
	5.10	900,000	1.210	.0131	92.3	23.3	10,323
U. S. A. 35 A	10.14	1,890,000	1.295	.0117	110.6	21.6	15,865
	19.92	3,570,000	1.387	.0115	120.5	22.3	20,176
	1.00	180,000	1.580	.0226	70.0	18.2	7,722
	2.48	450,000	1.500	.0189	79.4	18.6	9,448
U. S. A. 35 B	5.37	960,000	1.440	.0142	101.3	19.9	14,808
	10.25	1,890,000	1.240	.0148	83.8	19.9	8,704
	20.30	3,520,000	1.210	.0138	87.6	19.6	9,302
	1.00	163,000	1.250	.0207	60.3	16.7	4,558
Clark Y	2.45	415,000	1.254	.0141	89.0	19.4	9,919
	5.24	859,000	1.301	.0110	118.3	20.1	18,199
	10.20	1,695,000	1.380	.0100	138.0	20.8	26,281
	19.82	3,470,000	1.380	.0092	150.2	21.8	31,050
R. A. F. 15	1.00	181,000	1.215	.0127	95.6	25.1	11,120
	2.52	480,000	1.190	.0105	118.3	24.1	15,285
	5.44	965,000	1.197	.0097	123.4	24.0	18,228
	10.20	1,850,000	1.330	.0112	118.8	22.1	18,765
Göttingen 387	20.40	3,610,000	1.373	.0106	129.5	22.4	23,036
	1.00	185,000	1.067	.0101	105.7	24.5	11,908
	2.51	461,000	1.061	.0093	114.0	24.5	13,809
	5.10	950,000	1.063	.0094	113.0	25.0	13,594
Göttingen 387	10.75	2,060,000	1.095	.0089	110.6	23.6	13,396
	20.00	3,580,000	1.216	.0083	146.6	25.8	26,100
	1.00	173,000	1.420	.0272	51.2	15.3	3,870
	2.52	440,000	1.395	.0188	74.1	16.8	7,686
Göttingen 387	5.37	940,000	1.380	.0136	101.5	19.2	14,209
	10.20	1,820,000	1.310	.0128	102.3	18.7	13,721
	19.80	3,470,000	1.330	.0124	107.3	19.6	15,301

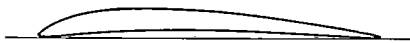
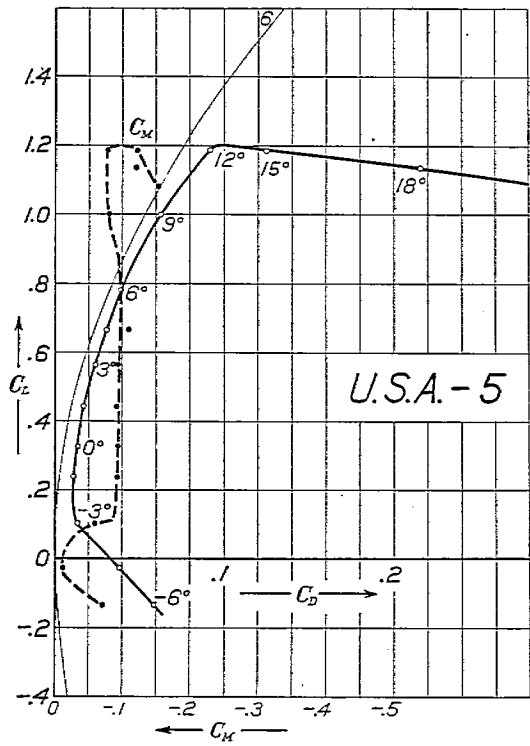

Tank pressure, atmospheres	Dynamic pressure $q = \text{kg/m}^2$	Reynolds Number
20.07	640.00	3,630,000

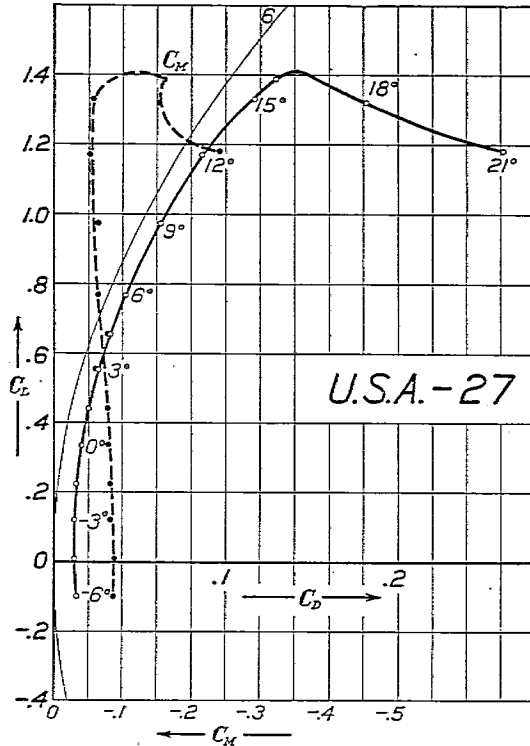

Tank pressure, atmospheres	Dynamic pressure $q = \text{kg/m}^2$	Reynolds Number
19.92	636.00	3,570,000

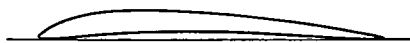
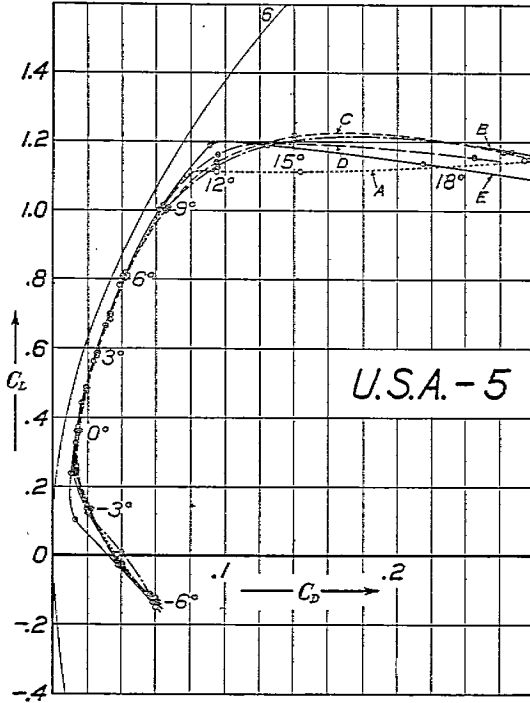

	Tank pressure, atmospheres	Dynamic pressure $q = \text{kg/m}^2$	Reynolds Number
Curve A	1.00	28.00	179,000
Curve B	2.62	76.10	482,000
Curve C	4.86	139.20	863,000
Curve D	10.48	310.00	1,840,000
Curve E	20.07	640.00	3,630,000

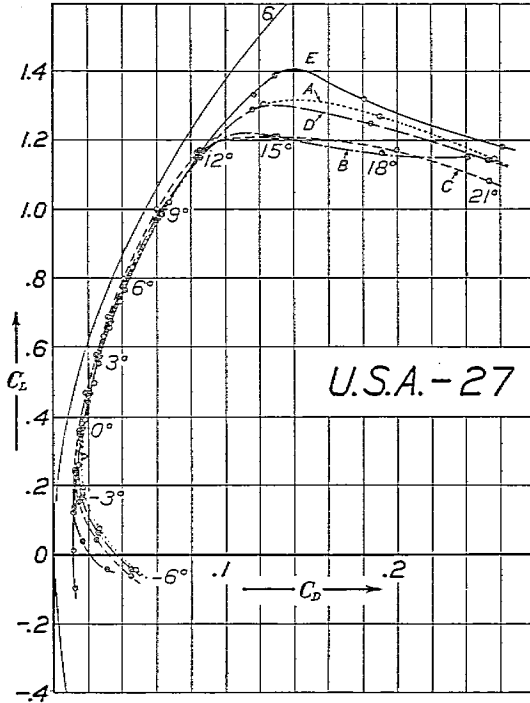

	Tank pressure, atmospheres	Dynamic pressure $q = \text{kg/m}^2$	Reynolds Number
Curve A	1.00	27.00	175,000
Curve B	2.58	72.50	456,000
Curve C	5.10	147.00	900,000
Curve D	10.14	318.00	1,890,000
Curve E	19.92	636.00	3,570,000

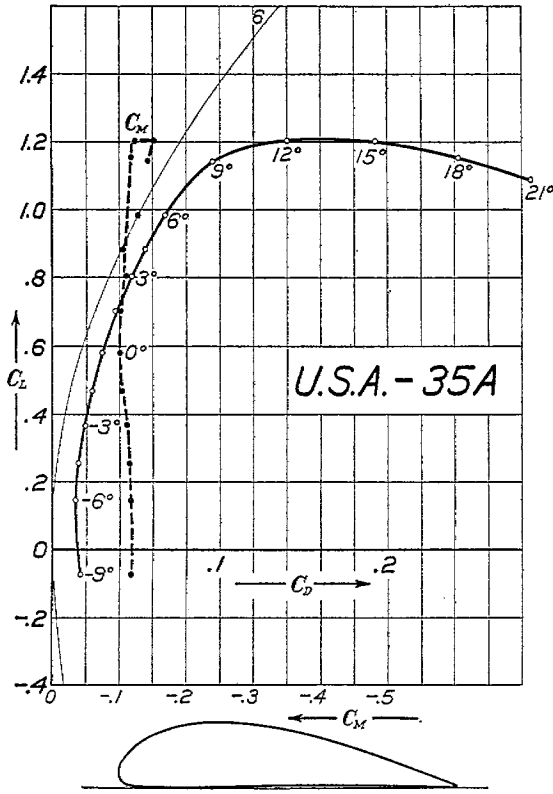

Tank pressure, atmospheres	Dynamic pressure $q = \text{kg/m}^2$	Reynolds Number
20.30	624.00	3,520,000

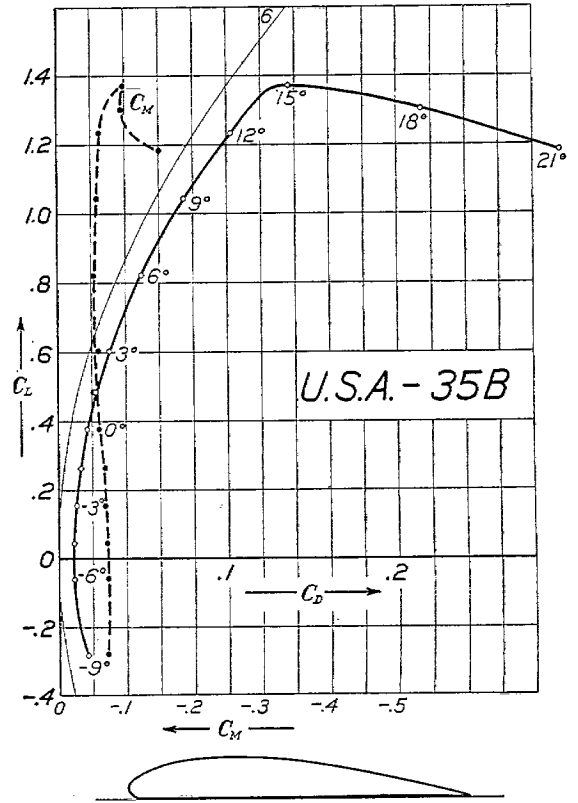

Tank pressure, atmospheres	Dynamic pressure $q = \text{kg/m}^2$	Reynolds Number
19.82	622.00	3,470,000

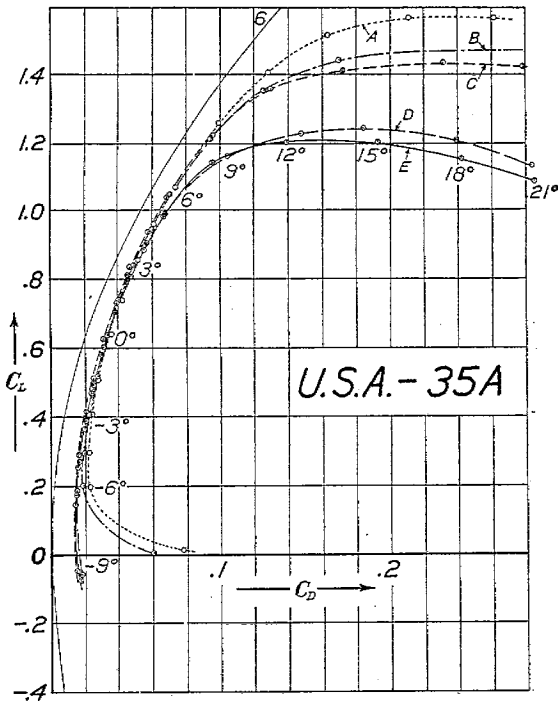

	Tank pressure, atmospheres	Dynamic pressure $q = \text{kg/m}^2$	Reynolds Number
Curve A.....	1.00	28.00	180,000
Curve B.....	2.48	72.00	450,000
Curve C.....	5.37	156.00	960,000
Curve D.....	10.25	310.00	1,860,000
Curve E.....	20.30	624.00	3,520,000

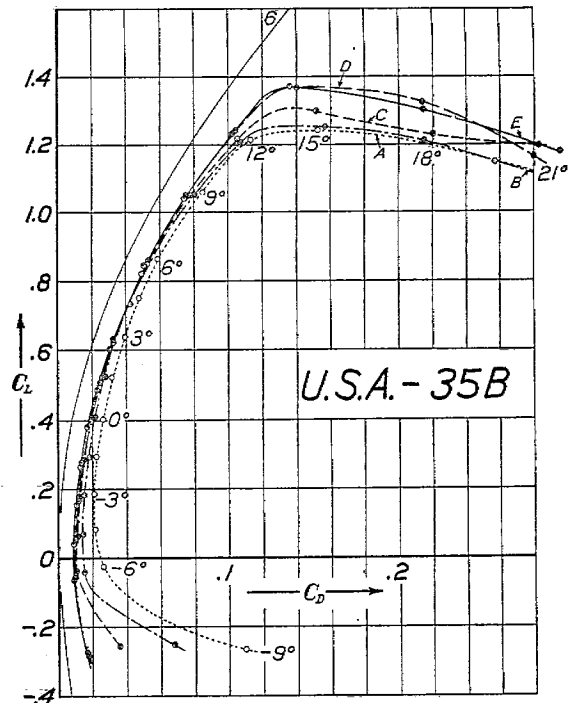

	Tank pressure, atmospheres	Dynamic pressure $q = \text{kg/m}^2$	Reynolds Number
Curve A.....	1.00	25.20	163,000
Curve B.....	2.45	65.00	415,000
Curve C.....	5.24	145.00	859,000
Curve D.....	10.20	289.50	1,695,000
Curve E.....	19.82	622.00	3,470,000

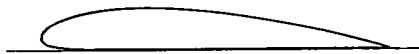
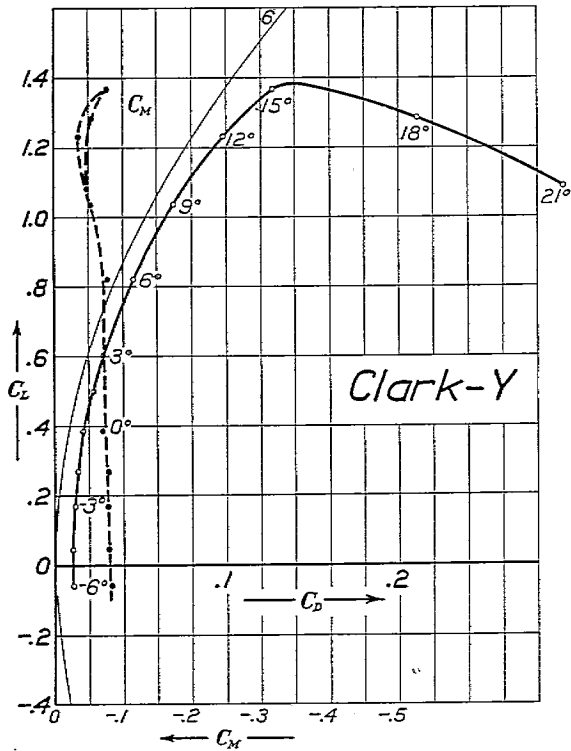

Tank pressure, atmospheres	Dynamic pressure $q = \text{kg/m}^2$	Reynolds Number
20.40	632.00	3,610,000

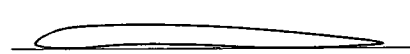
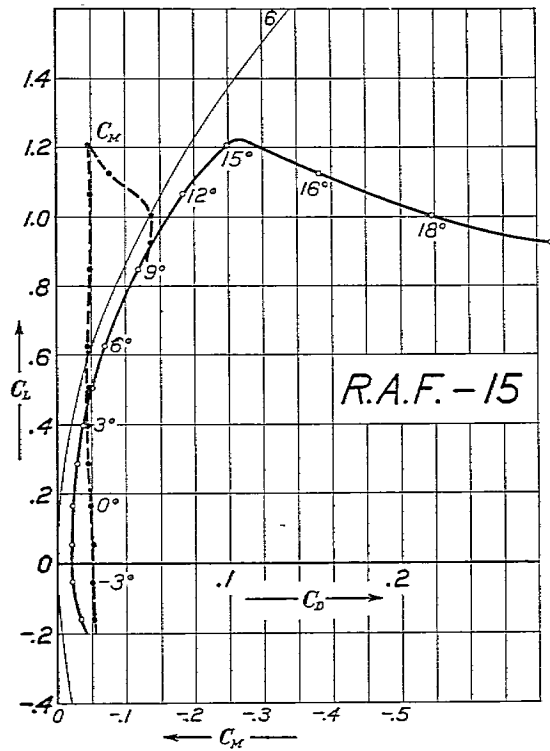

Tank pressure, atmospheres	Dynamic pressure $q = \text{kg/m}^2$	Reynolds Number
20.00	630.00	3,530,000

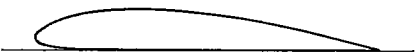
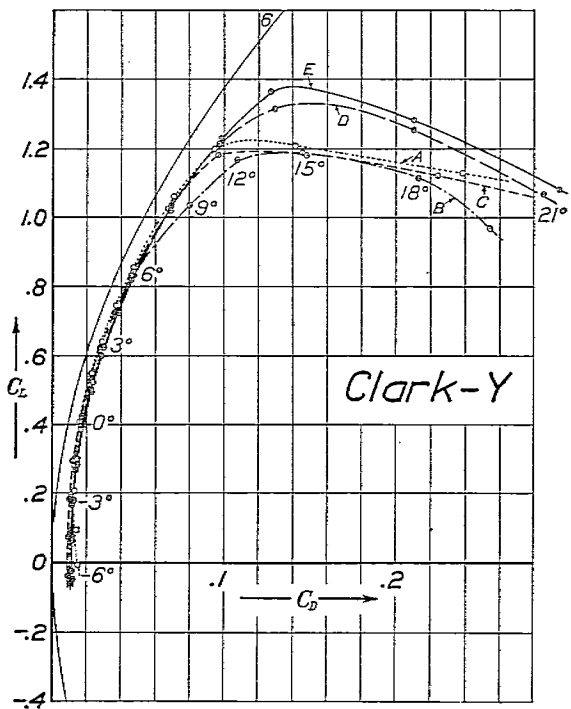

	Tank pressure, atmospheres	Dynamic pressure $q = \text{kg/m}^2$	Reynolds Number
Curve A	1.00	28.10	181,000
Curve B	2.52	71.80	460,000
Curve C	5.44	155.00	965,000
Curve D	10.20	353.00	1,850,000
Curve E	20.40	632.00	3,610,000

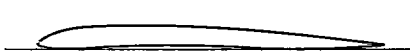
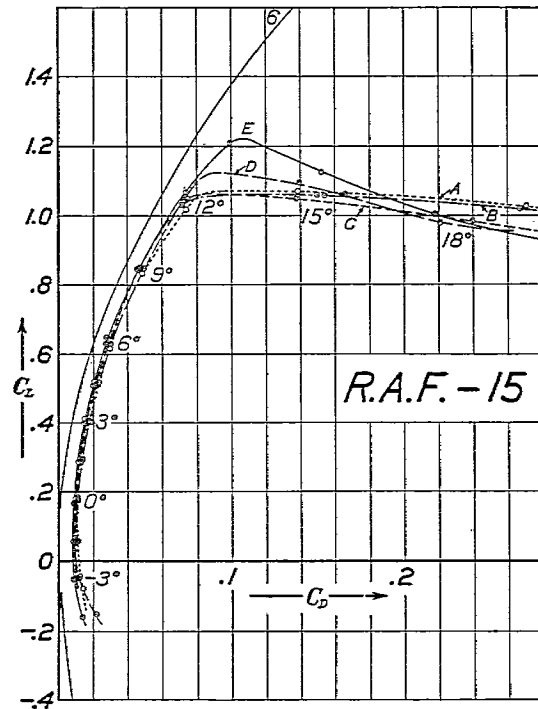

	Tank pressure, atmospheres	Dynamic pressure $q = \text{kg/m}^2$	Reynolds Number
Curve A	1.00	28.60	185,000
Curve B	2.51	72.70	461,000
Curve C	5.10	152.00	950,000
Curve D	10.75	335.00	2,060,000
Curve E	20.60	630.00	3,530,000

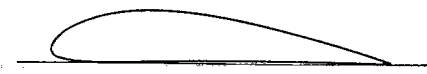
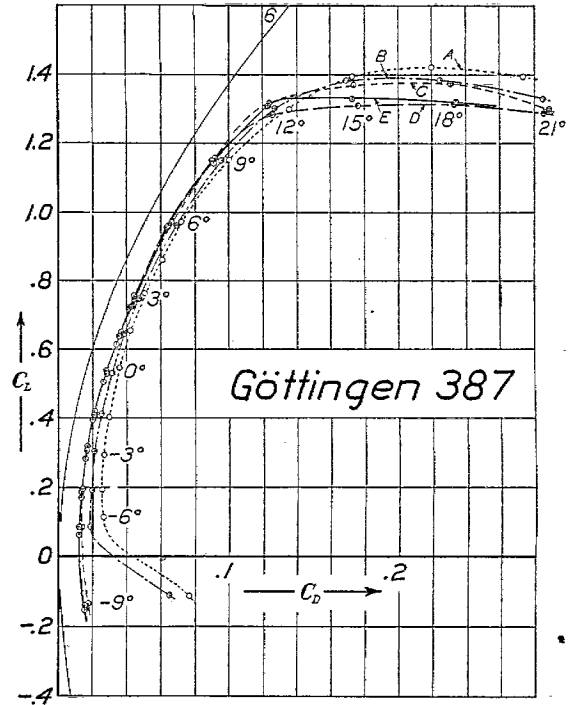
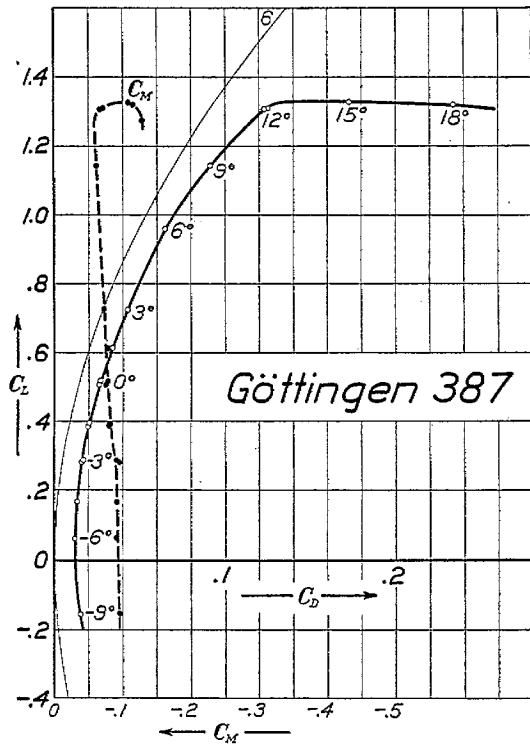

Tank pressure, atmospheres	Dynamic pressure $q = \text{kg/m}^2$	Reynolds Number
19.80	620.00	3,470,000

	Tank pressure, atmospheres	Dynamic pressure $q = \text{kg/m}^2$	Reynolds Number
Curve A	1.00	26.25	173,000
Curve B	2.52	67.80	440,000
Curve C	5.37	151.00	940,000
Curve D	10.20	305.00	1,820,000
Curve E	19.80	620.00	3,470,000