

---

---

**REPORT No. 222**

---

**SPRAY PENETRATION WITH A SIMPLE  
FUEL INJECTION NOZZLE**

By **HAROLD E. MILLER** and **EDWARD G. BEARDSLEY**  
Langley Memorial Aeronautical Laboratory



# REPORT No. 222

## SPRAY PENETRATION WITH A SIMPLE FUEL INJECTION NOZZLE

By Harold E. Miller and Edward G. Beardsley

### SUMMARY

The tests covered by this report form a part of a general investigation of the application of fuel injection engine principles to aircraft engine service. The purpose of these tests was to obtain specific information on the rate of penetration of the spray from a simple injection nozzle, having a single orifice with a diameter of .015 inch when injecting into compressed gases.

The fuel was sprayed into a chamber fitted with glass walls and filled with nitrogen at various pressures. Special high-speed photographic apparatus, capable of taking a continuous series of 15 photographs at a rate of 4,000 per second, was used to record the development of single sprays. The effects of fuel pressures from 2,000 to 8,000 pounds per square inch and chamber pressures from atmospheric to 300 pounds per square inch on the rate of penetration and the development of the spray were studied.

The results have shown that the effects of both chamber and fuel pressures on penetration are so marked that the study of sprays by means of high-speed photography or its equivalent is necessary if the effects are to be appreciated sufficiently to enable rational analysis. It was found for these tests that the negative acceleration of the spray tip is approximately proportional to the 1.5 power of the instantaneous velocity of the spray tip.

### INTRODUCTION

It is usual to study the characteristics of sprays produced by fuel injection engine fuel nozzles by spraying into liquids or the atmosphere. While such tests are easily made, they are not entirely satisfactory, since the test conditions are far different from the actual conditions met in the engine cylinder.

Lack of information regarding the effect of the compressed gases on the spray handicaps the analysis of the action inside the engine cylinder. This fundamental information is especially desirable when applying fuel injection to aviation engines, since the conditions in this field are so different from those existing in low-speed engines now in use that commercial experiences can serve only as a very rough guide.

An item of major importance is the rate of penetration of the spray. Kuehn (Reference 1) gives information on the penetration of single drops of various diameters, but these data depend primarily on theoretical calculations and have little value for predicting the action of a fuel spray composed of a comparatively large quantity of liquid in different form. A complete theoretical analysis for the action of sprays necessitates assumptions that lead to uncertain results, so that direct experimental determinations are desirable. Since investigations of this nature have apparently not been made heretofore, this work was undertaken to provide some definite information for a simple nozzle.

### PHASES OF PROBLEM CONSIDERED

A simple injection valve, opened by a cam and closed by a compression spring, was used for the present work. A cylindrical nozzle having a diameter of 0.015 inch was used, and the valve needle lift was 0.007 inch.

Due to limitations of the apparatus, it was necessary to confine the study to spray lengths of less than 6 inches and to time periods of less than 0.005 second. While interesting data undoubtedly would have been obtained if the scope could have been extended to include greater spray lengths and longer time periods, the information was desired primarily as an aid in applying fuel injection to aviation engines where the conditions do not demand greater spray lengths or longer

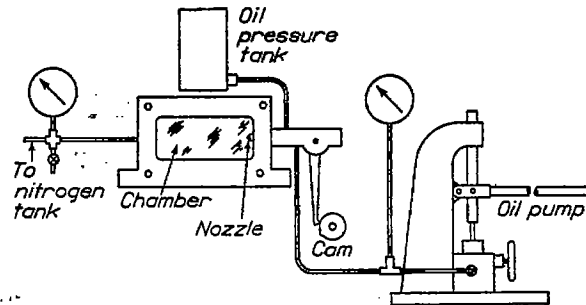

FIG. 1.—Diagrammatic arrangement of apparatus for production and control of spray

time periods. Fuel pressures between 2,000 and 8,000 pounds per square inch at 1,000 pounds per square inch intervals were investigated while injecting into a chamber filled with gas at atmospheric pressure and at 100, 200, and 300 pounds per square inch gauge. Due to strength limitations of the present chamber, greater chamber pressures were not investigated.

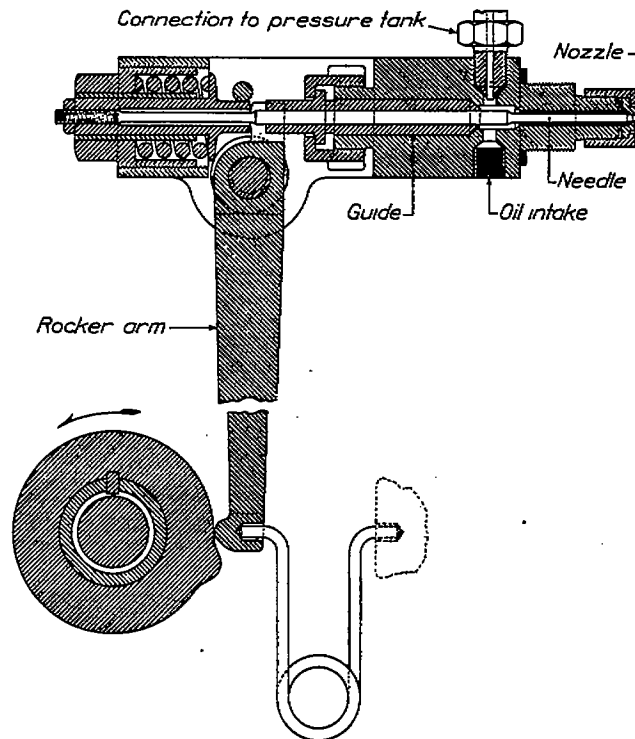

FIG. 2.—Fuel injection valve mechanism

#### APPARATUS AND METHOD OF OPERATION

The apparatus used for producing and controlling the fuel sprays is shown diagrammatically by Figure 1. The valve mechanism is shown in more detail in Figure 2. The cam shown in these two figures was arranged to make a single revolution at a speed of 900 revolutions per minute by means of a clutch mechanism such as is used on punch presses. A control lever engaged the clutch and thus connected the cam to a shaft rotated by an electric motor at 900



FIG. 3.—Injection pressure, 3,000 lb./sq. in. Chamber pressure, atmospheric

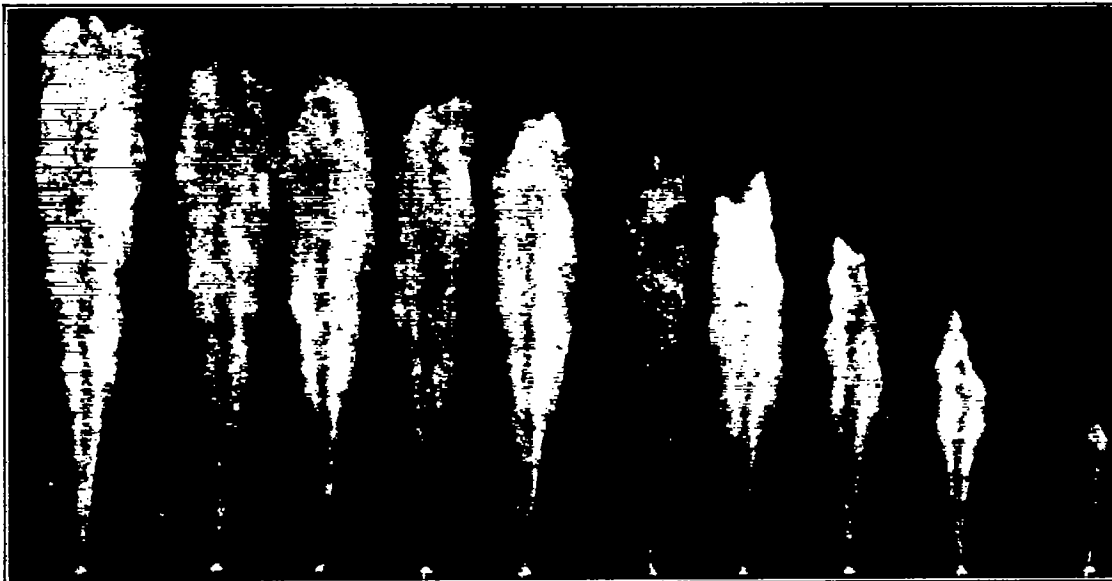

FIG. 4.—Injection pressure, 3,000 lb./sq. in. Chamber pressure, 100 lb./sq. in.



FIG. 5.—Injection pressure, 3,000 lb./sq. in. Chamber pressure, 200 lb./sq. in.  
The original photographs for figures 3 to 8 inclusive were retouched for reproduction purposes



FIG. 6.—Injection pressure, 3,000 lb./sq. in. Chamber pressure, 300 lb./sq. in



FIG. 7.—Injection pressure, 5,000 lb./sq. in. Chamber pressure, 300 lb./sq. in.



FIG. 8.—Injection pressure, 8,000 lb./sq. in. Chamber pressure, 300 lb./sq. in.  
The original photographs for figures 3 to 8 inclusive were retouched for reproduction purposes

revolutions per minute. The cam made one revolution and the clutch was then automatically disengaged. The cam lifted the spring-loaded injection-valve needle from its seat through the rocker arm, permitting the discharge of the fuel. The lift of the steel valve needle could be varied by rotating the eccentric rocker arm pin, but, for the present work, it was not changed.

The fuel system was of the constant pressure type, fuel being supplied to the injection valve by means of a hydraulic hand pump at the point shown in Figure 2. The pressure tank just above the nozzle was filled with air before hydraulic pressure was applied and served to minimize the pressure drop during an injection.

The nozzle was mounted at one end of a pressure chamber fitted with glass walls on two sides to permit visual and photographic observation of the spray. This chamber was filled with nitrogen from a pressure tank.

Special high-speed photographic apparatus, capable of taking a continuous series of fifteen photographs at a rate of 4,000 per second was used to record the development of single sprays. Illumination was obtained from a spark gap located near the focus of a parabolic reflector which directed the light into the spray chamber. A camera lens, mounted on the opposite side of the chamber, focused the spray image on a film fastened around a circular drum. This drum was rotated at 3,700 revolutions per minute in a plane perpendicular to the axis of the spray.

Fifteen glass plate condensers, charged to about 30,000 volts each, were arranged to discharge in sequence across the spark gap by means of a rotary switch. The time between condenser discharges, and hence between pictures, was regulated by varying the speed of the rotary switch. Discharge through the rotary switch and spark gap could not occur, until a master switch was closed. This master switch was operated simultaneously with the nozzle valve cam by the same clutch mechanism which controlled the cam.

The duration of a single exposure was estimated to be of the order of 0.000005 seconds. When injecting into gases at 300 pounds pressure, it was necessary to employ a rate of 2,000 exposures per second in order to show the travel of the spray tip across the chamber. When injecting into gas at atmospheric pressure, the rate was increased to 4,000 per second in order to obtain a complete series of pictures before the spray impinged on the opposite chamber wall. Intermediate rates were used for the intermediate chamber pressures.

By striking the control lever which engaged the clutch the injection of fuel and discharge of the condensers took place simultaneously and a record was obtained on the exposed film. All operation was carried out in a darkened room.

A high-grade Diesel engine fuel oil was used for all experiments.

#### DISCUSSION OF RESULTS

The results given here are for single sprays produced by a single revolution of the cam. It was not feasible to permit continuous operation of the injection system as in actual engines, as the fuel cloud formed in the chamber would obscure the spray. Although differences may exist between sprays under these conditions, visual observation has shown that when injecting into the atmosphere with the chamber removed, continuous operation gave less than 10 per cent greater penetration than obtained with a single spray.

Figures 3 to 8, inclusive, are reproductions of actual photographs taken during the investigation. There was not sufficient contrast in the original photographs to enable intelligible half-tones to be made so that it was necessary to retouch the photographs by increasing the depth of the background and accentuating the nozzle. Much care was taken to alter as little as possible the original outline of the spray. Figures 3 to 6, inclusive, compose a series in which the injection pressure is 3,000 pounds per square inch and the chamber pressure is varied from atmospheric to 300 pounds per square inch gage. Figures 6, 7, and 8 compose another series in which the chamber pressure is 300 pounds per square inch and the injection pressure is varied from 3,000 to 8,000 pounds per square inch.

From such photographs measurements were made of the lengths of the spray images and the distances between images. Figures 9 to 14, inclusive, were plotted from these measurements after taking into account the photographic reduction and the speed of film travel. While

data for figures were taken from a single series of photographs, these were checked by additional photographs and were shown to be representative.

The data given by Figure 15, showing the effect of fuel pressure on spray tip velocity, were obtained from Figure 12. The influence of the chamber and injection pressures on the development of the spray is shown quite markedly by these figures.

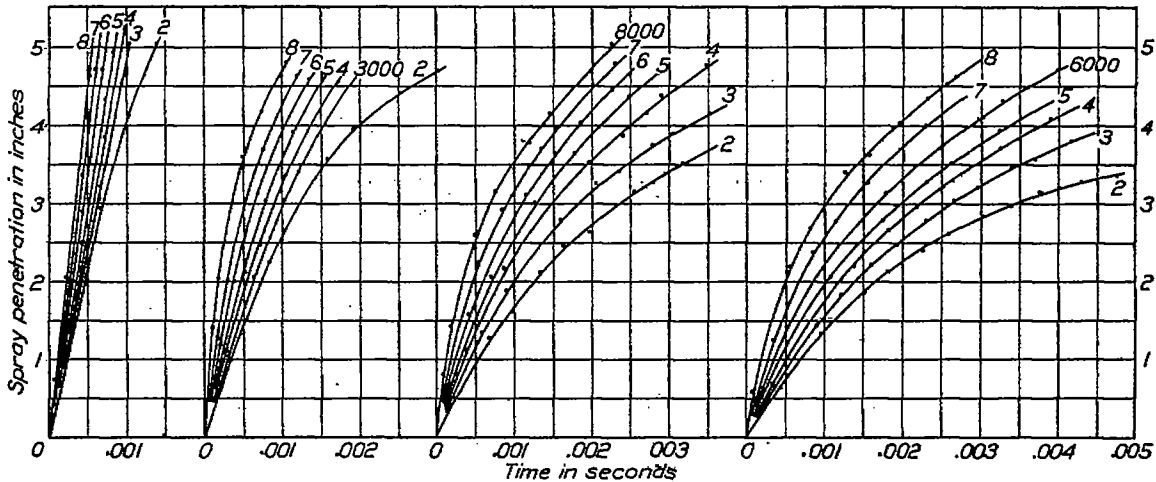

FIG. 9.

FIG. 10.

FIG. 11.

FIG. 12.

Chamber pressure, atmospheric. Fuel pressure, 2,000 to 8,000 lb./sq. in.

Chamber pressure, 100 lb./sq. in. gage. Fuel pressure, 2,000 to 8,000 lb./sq. in.

Chamber pressure, 200 lb./sq. in. gage. Fuel pressure, 2,000 to 8,000 lb./sq. in.

Chamber pressure, 300 lb./sq. in. gage. Fuel pressure, 2,000 to 8,000 lb./sq. in.

Effect of fuel pressure on penetration

Figure 16 shows that injection would have been completed in about 0.003 second if the valve needle followed the cam. None of the pictures taken included the entire period of injection, and since time intervals of nearly 0.005 second were recorded it is evident that the cam

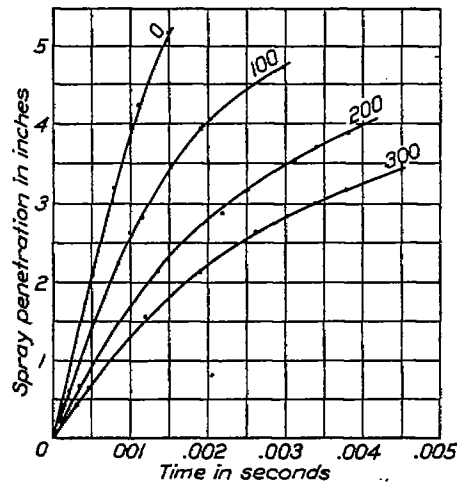

FIG. 13.—Effect of chamber pressure on penetration. Fuel pressure, 2,000 lb./sq. in. Chamber pressure 0 to 300 lb./sq. in. gage

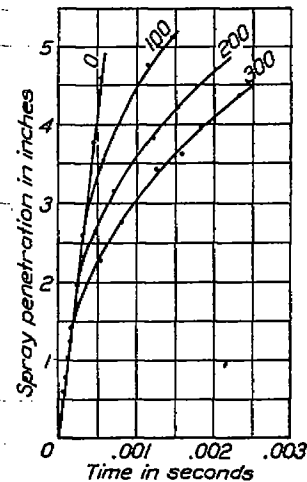

FIG. 14.—Effect of chamber pressure on penetration. Fuel pressure, 8,000 lb./sq. in. Chamber pressure, 0 to 300 lb./sq. in. gage

did not control the closing of the valve. This action is an explanation of the character of the nozzle calibration curve, Figure 17. Several series of calibrations were made at atmospheric and at 300 pounds per square inch chamber pressure, none of which differed perceptibly from those given on the curve.



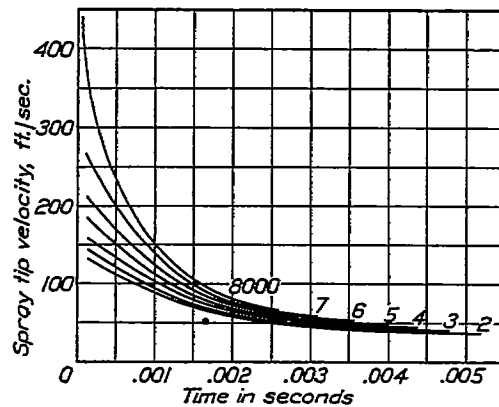

FIG. 15.—Effect of fuel pressure on spray tip velocity. Chamber pressure, 300 lb./sq. in. Fuel pressure, 2,000 to 8,000 lb./sq. in.

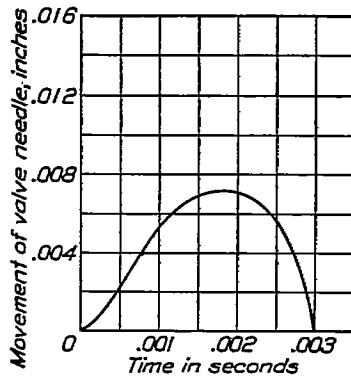

FIG. 16.—Valve lift diagram

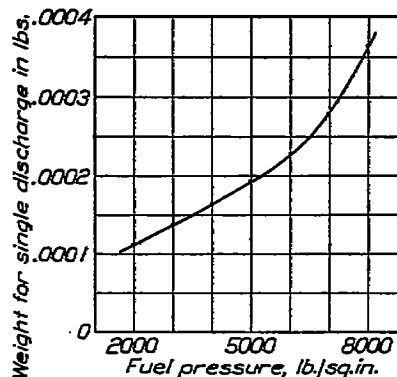

FIG. 17.—Weight of fuel discharged by nozzle

MATHEMATICAL CONSIDERATIONS

The formulation of the mathematical relationships governing the action of liquids injected into compressed gases is considerably involved because of the large number of variables and a lack of knowledge of the true action. Analysis of the experimental results revealed that for the present tests the negative acceleration of the spray tip is approximately proportional to the 1.5 power of the instantaneous velocity of the spray tip.

The applicability of this relation can be readily shown. Assuming such a relation to apply, the mathematical equation will be:

$$-\frac{dv}{dt} = 2kV^{1.5} \tag{1}$$

This may be expressed as:

$$s = \frac{V_0 t}{kV_0^{1.5} t + 1} \tag{2}$$

where  $s$  = spray length or penetration in feet.

$t$  = time in seconds.

$k$  = coefficient.

$V_0$  = initial velocity in feet per second.

Equation (2) may be verified by differentiation. From this equation is derived

$$\frac{t}{s} = \frac{kV_0^{1.5} t}{1} + \frac{1}{V_0} \tag{3}$$

which is an equation of a straight line for  $\frac{t}{s}$  as a function of  $t$ . Values of these variables taken

from Figures 9 to 12, inclusive, give the data plotted on Figures 18 to 20. Since the divergence from straight lines is not very great, equation (1) closely represents the physical conditions within the limits of the experiments.

It is interesting to note that equation (3) may be arranged as in equation (4).

$$s = \frac{V_0}{kV_0^s + \frac{1}{t}} \quad (4)$$

From this equation it becomes apparent that  $s = \frac{V_0}{kV_0^s}$  when  $t = \infty$  so that this equation gives the penetration that would be obtained if discharge never ceased or the limiting value of penetration for the chamber and fuel pressures under consideration. It is evident from equation (3) that  $\frac{V_0}{kV_0^s}$  is the reciprocal of the slope of the lines in Figures 18 to 20, and thus a means is obtained of estimating the limiting value of the penetration. Since the condition was not examined experimentally, there is no assurance that the straight lines may be extended, and this operation has little practical utility at the present time. Nevertheless, it probably constitutes the best way to extrapolate the present data. It is interesting to note that, if it is assumed that the data may be extended in this way, the penetration increases with

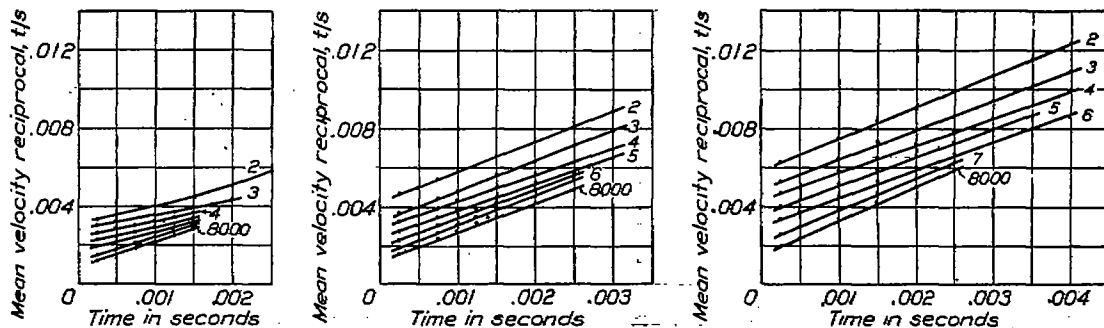

Fig. 18.—Chamber pressure, 100 lb./sq. in. Fig. 19.—Chamber pressure, 200 lb./sq. in. Fig. 20.—Chamber pressure 300 lb./sq. in.

Fuel pressure, 2,000 to 8,000 lb./sq. in. Relation of mean velocity reciprocal (1/s) to time.

fuel pressure to a certain maximum value, after which it decreases with further increases of fuel pressure.

Figure 15 shows that the higher fuel pressures are accompanied by higher initial velocities, but after a certain time interval the spray-tip velocity is nearly the same over a wide range of fuel-pressure variation. The higher initial velocities are probably accompanied by greater atomization, as is indicated by other experiences, and thus the higher pressures would have other beneficial effects besides their influence on penetration.

#### CONCLUSIONS

These tests have given definite information on the rate of spray penetration from a simple nozzle and on the variation of this rate with various fuel and gas pressures. The extent to which the present results depend on the particular characteristics of the present injection apparatus can only be determined by tests with other types.

Records of the development of fuel sprays injected into compressed gases, obtained by means of high-speed photography, provide a good basis for the analysis of the behavior of sprays produced by various injection nozzles, and therefore should aid materially in considering the influence that the nozzles would have on engine performance.

#### REFERENCE

1. Ueber die zerstaubung flussiger Brennstoffe, by Dr. Ing. R. Kuehn, Der Motorwagen, January 20, 1925.